

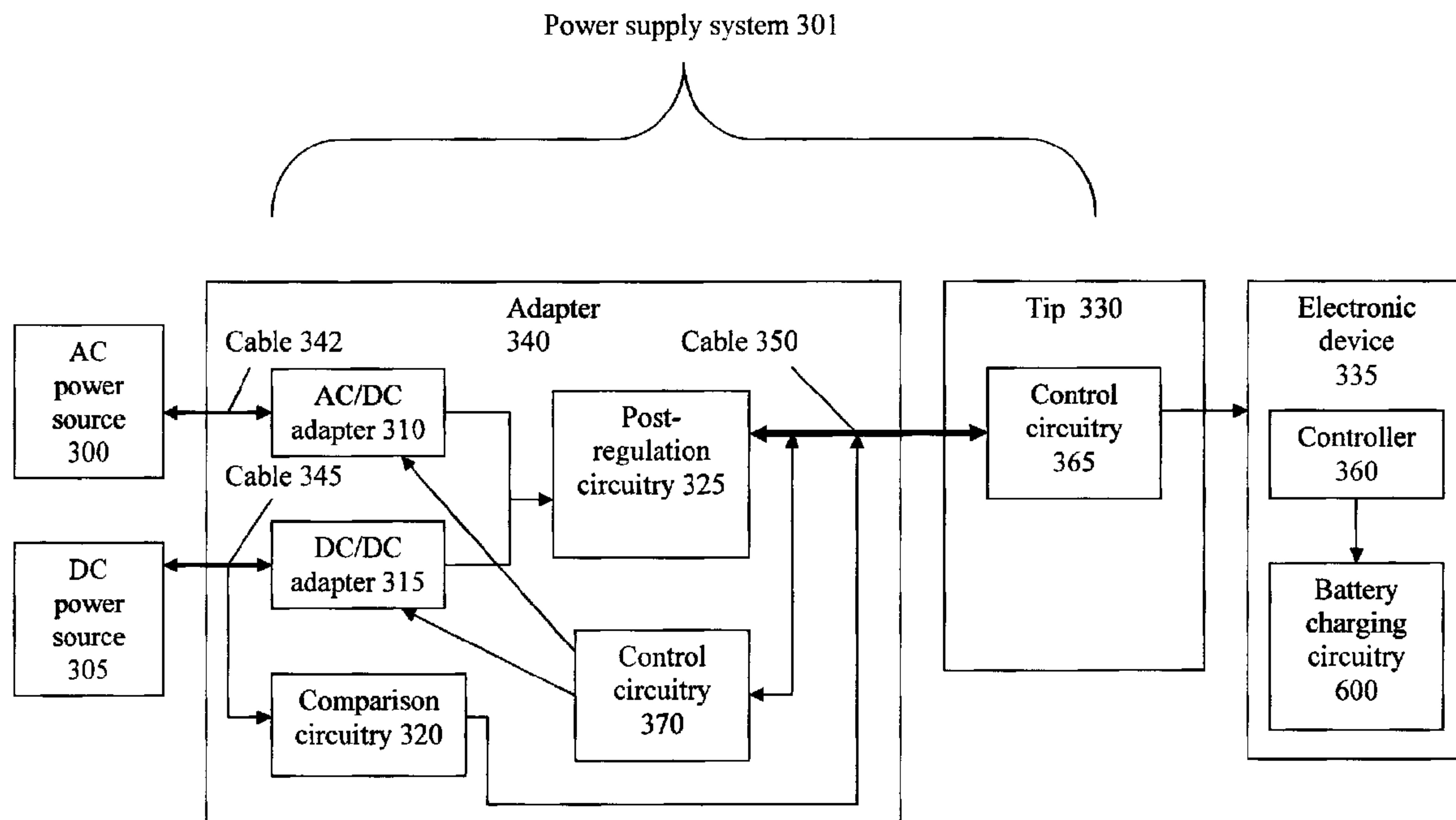

(22) Date de dépôt/Filing Date: 2007/11/20  
 (41) Mise à la disp. pub./Open to Public Insp.: 2008/05/28  
 (45) Date de délivrance/Issue Date: 2012/01/17  
 (30) Priorité/Priority: 2006/11/28 (US11/604950)

(51) Cl.Int./Int.Cl. *H02J 4/00* (2006.01),  
*G06F 1/28* (2006.01), *G07C 11/00* (2006.01),  
*H02J 1/00* (2006.01), *H02M 3/00* (2006.01)  
 (72) Inventeur/Inventor:  
 LANNI, THOMAS W., US  
 (73) Propriétaire/Owner:  
 COMARCO WIRELESS TECHNOLOGIES, INC., US  
 (74) Agent: OYEN WIGGS GREEN & MUTALA LLP

(54) Titre : POINTE DETACHABLE POUR COMMUNIQUER AVEC UN ADAPTATEUR ET UN DISPOSITIF ELECTRONIQUE  
 (54) Title: DETACHABLE TIP FOR COMMUNICATING WITH ADAPTER AND ELECTRONIC DEVICE



(57) **Abrégé/Abstract:**

A detachable tip, utilized with a power adapter, includes a memory, a receiver, and a transmitter. The memory stores a character string, the character string identifying whether an approved power adapter is coupled to the detachable tip. The receiver receives an identification request from an electronic device. In response to the identification request, a transmitter transmits the stored character string to the electronic device. A controller may extract the character string from the memory and send the character string to the transmitter. Instead of a character string, the memory may store a value, which is representative of a maximum power output available. A detachable tip may include an input connector and an output connector. The input connector receives a value from the power adapter, the value being representative of a maximum power available from the power adapter. The output connector passes through the value to the electronic device.

ABSTRACT OF THE DISCLOSURE

A detachable tip, utilized with a power adapter, includes a memory, a receiver, and a transmitter. The memory stores a character string, the character string identifying whether an approved power adapter is coupled to the detachable tip. The receiver receives an identification request from an electronic device. In response to the identification request, a transmitter transmits the stored character string to the electronic device. A controller may extract the character string from the memory and send the character string to the transmitter. Instead of a character string, the memory may store a value, which is representative of a maximum power output available. A detachable tip may include an input connector and an output connector. The input connector receives a value from the power adapter, the value being representative of a maximum power available from the power adapter. The output connector passes through the value to the electronic device.

TITLE OF THE INVENTION

DETACHABLE TIP FOR COMMUNICATING WITH ADAPTER AND ELECTRONIC  
DEVICE

5

BACKGROUND OF THE INVENTION1. Technical Field

This invention relates to tips for coupling DC power adapters to electronic devices and  
10 having the tip provide communication to power adapters and electronic devices.

2. Description of the Related Arts

There are power systems in the art which allow a user to hook up a DC/DC adapter to an  
automobile outlet, to supply regulated DC power to power an electronic device, such as a  
notebook computer. Automobile outlets typically provide a DC voltage in a range between 11.0  
15 and 14.1 Volts. Some power systems also allow the user to hook up the DC/DC adapter to an  
airplane output such as the EMPOWER system. EMPOWER typically provides a DC voltage in  
a range between 14.5 and 15.5 Volts.

Accordingly, some DC/DC adapters can be used with both an automobile outlet and the  
EMPOWER system to provide a regulated DC power to the electronic device such as the  
20 notebook computer. Notebook computers often contain lithium ion batteries. Such batteries can  
be recharged when the notebook computer is hooked up to the DC/DC adapter. For example, if  
the user is in a car, the user can couple a DC/DC adapter to the notebook computer and to the  
cigarette lighter outlet to power the notebook computer. The batteries in the notebook computer

will draw some of the DC power supplied to recharge the batteries of the notebook computer if they are low in power. Accordingly, the user can simultaneously use the notebook computer and recharge the batteries therein.

The user can also use the DC/DC adapter while on an airplane, by plugging the DC/DC  
5 adapter into the EMPOWER outlet. The EMPOWER outlet and the automobile outlets have different sizes and shapes. Accordingly, the user can directly plug the DC/DC adapter into the EMPOWER outlet, and can place a connector over the EMPOWER plug of the DC/DC adapter and then plug the connector into the automobile cigarette lighter outlet. When the user hooks the DC/DC adapter up to the EMPOWER outlet and then to the electronic device, the electronic  
10 device receives the regulated DC power. However, if the charging circuitry in the battery malfunctions, the battery can overheat or even catch on fire when recharging from an EMPOWER DC source. If the battery were to catch on fire while an airplane in which the emPlover outlet is located is flying, the fire would have the potential to cause the airplane to crash or cause substantial damage.

15 To address this problem, one system in the art provides a connector to connect between the DC/DC adapter and the notebook computer to inform the notebook computer not to recharge the batteries. FIG. 1 illustrates a power supply system according to the prior art. As shown a DC power source 100 is coupled to a DC/DC adapter 105 via a cable 102. The DC/DC adapter 105 receives power from the DC power source 100 and outputs regulated DC power to an electronic  
20 device 120, via a cable 110 and a connector 115 coupled to the end of the cable 110.

The DC/DC adapter 105 can provide three output pins to the electronic device 120, as shown in FIGS. 2A and 2B of the prior art. The first pin can provide the output voltage (i.e.,  $V_{out}$ ), the second pin can provide a ground reference (i.e., GND), and the third pin can provide a

data line (i.e.,  $V_{data}$ ) to instruct the notebook as to whether the batteries should be recharged or not. For example, as shown in FIG. 2A,  $V_{data}$  could be tied to GND to indicate that the DC power source 100 is the EMPOWER system and therefore the battery should not be recharged.

Alternatively, as shown in FIG. 2B,  $V_{data}$  could also be left open (i.e., to provide a non-grounded floating voltage) when the DC power source 100 is in a cigarette lighter outlet of an automobile. Accordingly, when using the DC/DC adapter 105 while in an automobile, the user would use a connector 115 having the  $V_{data}$  line floating, and when using the DC/DC adapter 105 with the EMPOWER system of an airplane, the user would use a connector 115 having the  $V_{data}$  line tied to GND.

However, problems arise when the user forgets to change replace the connector 115 for use with the automobile when the user is in an airplane. Accordingly, if the user has the wrong connector 115 attached when using with the EMPOWER system, a battery of an electronic device 120 such as a notebook computer can charge the battery even when used with the EMPOWER system, and if the charging circuitry of the battery malfunctions, overheating or even a fire can occur, resulting in damage to the notebook computer. Also, if the connector 115 is damaged or flawed, then it may not provide the correct  $V_{data}$  signal to the notebook computer, allowing the notebook computer to recharge the batteries in an airplane when they shouldn't be allowed to do so.

Accordingly, current DC/DC power adapter systems are deficient because they are incapable of automatically and intelligently informing an electronic device 120 coupled thereto of the DC power source (i.e., the EMPOWER system or an automobile cigarette lighter outlet).

#### BRIEF DESCRIPTION OF THE DRAWINGS

FIG. 1 illustrates a power supply system according to the prior art;

FIG. 2A illustrates a first connector to coupled a power supply system to an electronic device according to the prior art;

FIG. 2B illustrates a second connector to coupled a power supply system to an electronic device according to the prior art;

FIG. 3 illustrates a power supply system according to an embodiment of the invention;

FIG. 4A illustrates a tip having digital control circuitry according to an embodiment of the invention;

FIG. 4B illustrates a tip having analog control circuitry according to an embodiment of the invention;

FIG. 5A illustrates comparison circuitry according to an embodiment of the invention;

FIG. 5B illustrates comparison circuitry according to an additional embodiment of the invention;

FIG. 6 illustrates an electronic device according to an embodiment of the invention;

FIG. 7A illustrates a method of determining and outputting  $V_{data}$  according to an embodiment of the invention;

FIG. 7B illustrates a method of receiving  $V_{data}$  and allowing power to flow to devices within the electronic device based on  $V_{data}$  according to an embodiment of the invention;

FIG. 8 illustrates a power supply system according to an embodiment of the invention;

FIGS. 9A and 9B illustrate a tip including control circuitry according to embodiments of the invention;

FIG. 10 illustrates a tip including control circuitry and a measurement circuit according to an embodiment of the invention; and

FIG. 11 illustrates a power supply system including a tip according to an embodiment of the invention.

### DETAILED DESCRIPTION

5 An embodiment of the present invention is directed to a power supply system to determine a DC power source (e.g., an automobile cigarette lighter outlet or an EMPOWER airplane outlet) coupled thereto and send a signal indicative of the power source to an electronic device coupled thereto. The electronic device may be a notebook computer or other portable consumer electronic device, for example. Based on the signal sent to the electronic device, the  
10 electronic device may control the amount of power drawn to prevent overheating. For example, when a notebook computer is hooked up and the power source is the EMPOWER system, the electronic device may disable charging of the internal batteries of the notebook computer, in order to prevent damage or overheating of the batteries due to malfunction or failure. The DC power source may be determined by voltage comparison circuitry, such as a comparator, or by a  
15 voltage comparison device including a processor.

FIG. 3 illustrates a power supply system 301 according to an embodiment of the invention. As shown, the adapter 340 may be used with an AC power source 300 or a DC power source 305. In other embodiments, only a DC power source 305 may be utilized to supply power. The AC power source 300 may be coupled to an AC/DC adapter 310 via a cable 342.  
20 The DC power source 305 may be coupled to both a DC/DC adapter 315 and comparison circuitry 320 via a cable 345. The DC power source 305 may be an automobile's cigarette lighter outlet or an airplane's EMPOWER system outlet, for example. AC/DC adapter 310 may convert AC power from the AC power source 300 into regulated DC power, which is supplied to

post-regulation circuitry 325. The post-regulation circuitry 325 may provide an output voltage ( $V_{out}$ ) and a ground reference (GND) to a tip 330 coupled to the adapter 340 via a cable 350, as further explained below with respect to FIGS. 4A and 4B. The tip 330 may be coupled to an electronic device 335 to provide the power thereto from the power supply system 301. The tip 5 330 may be removable from the cable 350 and may be inserted into a power input opening of the electronic device. Tips 330 may have different shapes and sizes, depending up the shape and sizes of the power input openings of the respective electronic devices 335 being powered. The tip 330 may also include control circuitry 365 to provide a signal to control circuitry 370 of the adapter 340. The signal may be sent to the control circuitry 370 via the cable 350. In one 10 embodiment, the control circuitry 365 of the tip 330 may include digital components to provide a digital signal the control circuitry 370 of the adapter 340. The digital signal may be utilized to set the magnitude of  $V_{out}$  and limit the amount of current which may be drawn from the adapter 340. The post-regulation circuitry 325 regulates the voltage to what the tip 330 tells it to provide.

15           Alternatively, the tip 330 may include analog components and may provide voltage programming and current programming voltages ( $V_{Vprogram}$  and  $V_{Iprogram}$ , respectively) to the adapter 340.  $V_{Vprogram}$  may be utilized to set the magnitude of  $V_{out}$ . For example, there may be a linear relationship between  $V_{Vprogram}$  and  $V_{out}$  where  $V_{out}$  is 3 times as large as  $V_{Vprogram}$ . Accordingly, if  $V_{Vprogram}$  had a magnitude of 3.0 Volts,  $V_{out}$  would have a magnitude of 9.0 20 Volts, and if  $V_{Vprogram}$  had a magnitude of 3.0 Volts,  $V_{out}$  would have a magnitude of 6.0 Volts. The analog circuitry may contain passive or active components.



Accordingly, regardless of whether the tip 330 has analog or digital control circuitry, a single adapter 340 may be used to supply power to a plurality of different electronic devices 335 having different power requirements.

The adapter 340 may also include comparison circuitry 320. The comparison circuitry 5 320 may compare a magnitude of a voltage received from the DC power source 305 with a reference voltage to determine whether the DC power source 305 is an automobile cigarette lighter outlet or an EMPOWER airplane outlet. As stated above, automobile cigarette lighter outlets typically provide a DC voltage having a magnitude within the range of 11.0 Volts and 14.1 Volts. An EMPOWER airplane outlet typically provides a DC voltage having a magnitude 10 within the range of 14.5 and 15.5 Volts. Accordingly, the reference voltage may be set at a level between the high end of the automobile cigarette light outlet voltage (i.e., 14.1 Volts) and the low end of the EMPOWER airplane outlet voltage (i.e., 14.5 Volts). For example, the reference voltage may be set at 14.3 Volts. Accordingly, if the magnitude of the DC power source is greater than 14.3 Volts, then the comparison voltage may determine that the received DC voltage 15 has a greater magnitude than the reference voltage and the DC power source 305 is therefore the EMPOWER airplane outlet. However, if the magnitude of the DC power source is less than 14.3 Volts, then the comparison voltage may determine that the received DC voltage has a smaller magnitude than the reference voltage and the DC power source 305 is therefore the automobile cigarette lighter outlet.

20 The comparison circuitry 320 may output a signal  $V_{data}$  based upon whether the DC power source is determined to be the automobile cigarette lighter outlet or the EMPOWER airplane outlet. For example, the comparison may output 5 Volts if the automobile cigarette lighter outlet is detected, and 0.0 Volts if the EMPOWER airplane outlet is detected. In

alternative embodiments, different voltages for  $V_{data}$  may be used. In additional embodiments, the comparison circuitry 320 may output a digital signal, such as a stream of bits, indicative of the DC power source 305.  $V_{data}$  may be sent via cable 350 to the tip 330, and straight over to the electronic device 335. The electronic device 335 may include a controller 360 which is

5 responsive to  $V_{data}$ . For example, if the electronic device 335 is a notebook computer and  $V_{data}$  is indicative of the EMPOWER airplane outlet system, the controller 360 may disable battery charging circuitry 600, thereby preventing recharging of the batteries. And if the  $V_{data}$  is indicative of the automobile cigarette lighter outlet as the DC power source 305, the controller 360 may enabled battery charging circuitry to allow the batteries to be recharged.

10 Although FIG. 3 illustrates an adapter 340 which includes both a AC/DC adapter and a DC/DC adapter, other embodiments may include only a DC/DC adapter, and no AC/DC adapter.

FIG. 4A illustrates a tip 400 having digital control circuitry 402 according to an embodiment of the invention. As shown, the tip 400 receives  $V_{data}$ ,  $V_{out}$  and GND from the adapter 340 and allows them to all flow to the electronic device 335. The digital control circuitry

15 402 may receive the  $V_{out}$  and GND signals and may output a control signal to the adapter 340 to set the magnitude of  $V_{out}$  and limit the current provided. The control signal may be sent to the adapter 340 via the cable 350 between the tip 330 and the adapter 340. The digital control circuitry 402 may include a processor and a memory device, for example. In some embodiments, the tip 400 may be separable from cable 350, and in other embodiments, the tip

20 400 may be physically part of the cable 350.

FIG. 4B illustrates a tip 405 having analog control circuitry 410 according to an embodiment of the invention. As shown, the tip 405 receives  $V_{data}$ ,  $V_{out}$  and GND from the adapter 340 and allows them to all flow to the electronic device 335. The analog control

circuitry 410 may receive the  $V_{out}$  and GND signals and may output  $V_{V_{program}}$  and  $V_{I_{program}}$  to the adapter 340.  $V_{V_{program}}$  and  $V_{I_{program}}$  may be sent to the adapter 340 via the cable 350 between the tip 405 and the adapter 340. The analog control circuitry 400 may include passive or active components, for example. In some embodiments, the tip 400 may be separable from cable 350,  
5 and in other embodiments, the tip 400 may be physically part of the cable 350.

FIG. 5A illustrates comparison circuitry 320 according to an embodiment of the invention. As shown, the comparison circuitry 320 includes a comparator 500. The comparator 500 receives (a) the DC power signal from the DC power source 305, and (b) a reference voltage,  $V_{ref}$ . The comparator outputs  $V_{data}$  based on whether the magnitude of the DC power  
10 from the DC power source exceeds  $V_{ref}$ , as described above with respect to FIG. 3.

FIG. 5B illustrates comparison circuitry 320 according to an additional embodiment of the invention. As shown, the comparison circuitry 320 includes a processor 505. The processor 505 receives (a) the DC power signal from the DC power source 305, and (b) value of a reference voltage stored in memory. The processor 505 then outputs  $V_{data}$  based on whether the  
15 magnitude of the DC power from the DC power source exceeds  $V_{ref}$ , as described above with respect to FIG. 3. The processor 505 may output a single high or low voltage (e.g., 5.0 Volts or 0.0 Volts) based on the detected DC power source. Alternatively, the processor 505 may output a stream of bits to indicate the DC power source.

FIG. 6 illustrates an electronic device 335 according to an embodiment of the invention.  
20 As shown, the electronic device 335 may receive GND,  $V_{out}$  and  $V_{data}$  from the tip 330.  $V_{data}$  may be received by a controller 360. The controller 360 may disable battery charging circuitry 600 of the electronic device 335 from charging batteries when  $V_{data}$  is indicative of the

EMPOWER outlet. Alternatively, the controller 360 enable battery charging circuitry 600 so that the batteries of the electronic device may be charged on  $V_{data}$ .

FIG. 7A illustrates a method of determining and outputting  $V_{data}$  according to an embodiment of the invention. The processing shown in FIG. 7A may be implemented by the adapter 340. First, DC power is received 700 from the DC power source 305. Next, the comparison circuitry determines 705 whether the magnitude of the voltage of the DC power received is greater than  $V_{ref}$ . If “no,” the comparison circuitry determines the DC power source 305 to be an automobile cigarette lighter outlet, and processing proceeds to operation 710, where  $V_{data}$  is output with a signal/voltage magnitude indicating that the DC power source 305 is the automobile cigarette lighter outlet. Processing then returns to operation 700. If “yes,” at operation 705, processing proceeds to operation 715, where  $V_{data}$  is output with a signal/voltage magnitude indicating that the DC power source 305 is the EMPOWER airplane outlet.

FIG. 7B illustrates a method of receiving  $V_{data}$  and allowing power to flow to devices within the electronic device 335 based on  $V_{data}$  according to an embodiment of the invention. First, the electronic device 335 receives 720 the  $V_{data}$  signal. As discussed above, the  $V_{data}$  signal is sent from the adapter 340 through the tip 330 and over to the control circuitry 365 of the electronic device 335. Next, based on the  $V_{data}$  signal, a first set of predetermined devices may be prevented 725 from receiving power. For example, if the electronic device 335 is a notebook computer, the control circuitry 365 may prevent batteries from recharging if  $V_{data}$  indicates that the DC power source is the EMPOWER airplane outlet. Other devices/components in the electronic device 335 may also be prevented from receiving power or from functioning in a certain way.

At operation 730, a second set of predetermined devices may be allowed to receive power based on the  $V_{data}$  signal. For example, if  $V_{data}$  indicates that the DC power source is an automobile cigarette lighter outlet, then power may be available to batteries of the electronic device 335 to allow recharging. Other devices/components in the electronic device 335 may also  
5 be allowed to receive power or function in a particular way.

In embodiments described above, the  $V_{data}$  signal may be used to send a signal to the control circuitry 365 indicating the DC power source. This signaling may be done via a discrete bit, an analog signal, a data signal line, an analog voltage, or via any other suitable manner. The  $V_{data}$  signal may be transmitted from the adapter 340 to the tip 330 and electronic device 335 via  
10 a single signaling line or multiple signaling lines.

FIG. 8 illustrates a power supply system 800 according to an embodiment of the invention. The power supply system 800 is similar to the power supply system 301 shown in FIG. 3. However, unlike the power supply system 301, in which the adapter 340 itself contains comparison circuitry 370, the adapter 340 of power supply system 800 does not contain the  
15 comparison circuitry 805. Instead, a regular adapter 340 may be used and the electronic device 335 itself includes the comparison circuitry 805 for determining the DC power source. The electronic device 335 may be a notebook computer and may implement the methods shown in FIGS. 7A and 7B.

Fig. 9A illustrates a tip according to an embodiment of the present invention. The tip 900  
20 includes control circuitry 902 and a controller 950. The tip 900 is coupled to an adapter 940 and may have a cable disposed between the adapter 940 and the tip 900. The adapter 940 transmits  $V_{out}$  and GND to the tip 900. In an embodiment of the invention, digital or analog control circuitry 902 transmits a programming signal or a control signal to the adapter 940. In an

embodiment of the invention, digital or analog control circuitry 902 may transmit a plurality of programming signals to the adapter. Illustratively, digital or analog control circuitry 902 may transmit a voltage control signal to regulate the voltage output ( $V_{out}$ ) from the adapter 940. The digital or analog control circuitry 902 may also transmit a current control signal to limit the  
5 current output from the adapter 940. The  $V_{out}$  and GND signals are passed through the adapter 940 to the electronic device 935, such as a laptop, PDA, or cellular phone, to provide power to the electronic device.

In an embodiment of the invention, the tip 900 may also receive a value, which is illustrated by reference numeral 980 in Fig. 9A. The value may be representative of whether or  
10 not the power adapter is an approved adapter which can be connected to an electronic device 935. For example, for safety reasons, certain digital music player or laptop manufactures only desire to have certain manufacturers' power adapter connected to their system. Accordingly, the power adapter may transmit a value that indicates that the power adapter 940 is approved for powering the electronic device. Alternatively, the value may be representative of a maximum  
15 power output that is available at the time from the power adapter. For example, the value may represent that only 70 watts of power are available from the power adapter because the power adapter has been limited to that output power. Instead of receiving a value from the power adapter, the tip 900 may receive a character string. The character string may identify whether or not the power adapter is an approved adapter for powering the electronic device 935. The value  
20 or the character string may be received at input connector 985 of the tip 900. The input connector 985 may receive the value or character string and may pass through this signal or information to the output connector 990. Under certain operating conditions, there may be no modification of the value or character string in the tip 900. The output connector 990 is coupled

to the electronic device 935 and passes the value or character string to the electronic device. A conductor 995 may couple the input connector 985 to the output connector 990.

Fig. 9B illustrates an alternative embodiment of a tip according to an embodiment of the invention. In an embodiment of the invention, the tip 900 may include a controller 950, wherein the controller 950 includes a receiver 952, a memory 954, and a transmitter 956. In an alternative embodiment of the invention, a programmable Dallas Semiconductor programmable memory (i.e., DS2502) may be substituted for a controller and may include the receiver 952, memory 954, and transmitter 956. The receiver 952 may receive a signal from the electronic device 935. The signal may be a request from the electronic device 935 to interrogate the tip 900 and identify whether or not an approved power adapter 940 is coupled to the tip 900 and thus the electronic device 935. Once the controller 950 receives the request from the electronic device 935, the controller 950 extracts a character string from the memory 954 and utilizes the transmitter 956 to transmit the character string to the electronic device 935. The character string is representative of the power adapter to which the tip 900 is coupled. In an embodiment of the invention, a microcontroller may be programmed and could be utilized in place of the transmitter 956, a receiver 952, and a memory 954. The character string may represent that the power adapter 940 and/or tip 900 is approved to be connected to the electronic device, e.g., a laptop or a cellular phone. Under certain operating conditions, the character string represents that a rechargeable battery within the electronic device can be charged by the power adapter 940 and tip 900 combination. Under certain operating conditions, the character string is indicative of a maximum power available from the power adapter. Under certain operating conditions, a value can be stored in the memory 954 where the value is indicative for the maximum power available

from the power adapter. Illustratively, the value may be a power (or wattage) value or a current value.

The transmitter 956 may communicate with the electronic device 935 via a one-wire interface. The transmitter 956 may communicate with the electronic device 935 via other  
5 communication protocols, including serial communication protocols.

Fig. 10 illustrates a second embodiment of a tip according to an embodiment of the invention. The tip 900 may include an analog or digital control circuitry 910, a controller 940, and measurement circuit 960 (e.g., a voltage sense circuit or a current sense circuit). The measurement circuit 960 may measure a magnitude level of a programming or control signal  
10 e.g., ( $V_{Iprogram}$ ), that is being transmitted to the power adapter 940. In an embodiment of the invention, the programming or control signal has a value representative of a maximum current available to be output by the adapter 940. For example, a voltage magnitude of the programming or control signal identifies a value of current (e.g., in amperes) that the power adapter is available to output. Illustratively, each 0.5 volts in the programming or control signal may represent one  
15 amp of current that the power adapter can output. A programming or control signal having a magnitude of 2.5 volts represents that the power adapter is limited to output 5 amperes and the power output is limited to 100 watts (if the fixed voltage output is 20 volts). The measurement circuit 960 may be implemented using a comparator or a number of comparators that compare a voltage level of the control signal to a reference voltage level or a number of reference voltages.

20 In an alternative embodiment of the invention, the measurement circuit 950 may be implemented by an analog-to-digital converter. The analog-to-digital converter may measure a value of the control signal or the programming signal and identify the value which is representative of the power available to be output from the power adapter. In an embodiment of



the invention, the analog-to-digital converter may be used in conjunction with a microcontroller. The analog-to-digital converter may be separate from the microcontroller or the analog-to-digital converter may be incorporated into the microcontroller.

The measurement circuit 960 takes the measured magnitude level of the programming or control signal and sends the information to the controller 950. A memory 954 may store a plurality of character strings. Alternatively, the memory 954 may store a plurality of values. Each of the plurality of character strings or values may represent a potential power output level of the power adapter 940. For example, one character string may be represent that the power adapter can output 90 watts while another character string represents that the power adapter can output 140 watts. The controller 950 receives the magnitude level of the programming / control signal from the measurement circuit 960 and selects the corresponding character string stored in the memory 954. Alternatively, the controller receives the magnitude level or of the programming or control signal and selects the corresponding value stored in the memory 954.

After the corresponding character string or value is selected, the corresponding character string is transmitted to the electronic device 935 through the transmitter 956. The electronic device receives the character string and acts in response to the received character string or value. For example, the character string may indicate that the power adapter coupled to the tip (which is connected to the electronic device) can output 75 watts. Based on this information, a controller in an electronic device 935 (e.g., a laptop) may prevent the power adapter from charging the rechargeable battery within the electronic device 935 because the electronic device 935 may require all of the 75 watts of power.

The controller 950 may be a microcontroller. The controller 950 including the receiver 956, transmitter 952, and memory 954 may be a semiconductor memory chip such as a Dallas

Semiconductor DS2502 programmable memory. The receiver 956 and transmitter 952 may communicate with the electronic device via a number of protocols, e.g., the one-wire interface communication protocols, a serial interface communication protocol, etc.

Fig. 11 illustrates an alternative embodiment of a power supply system utilizing DC power source comparison circuitry according to an embodiment of the present invention. Fig. 11 is similar to the power supply system illustrated in Fig. 3 and also includes a microcontroller 950 in the tip 330. In Fig. 11, the microcontroller 950 receives a signal from the power adapter 340 in addition to the  $V_{out}$  signal and ground signal. The power source determination signal may be referred to as a  $V_{data}$  signal and may be generated by the comparison circuitry 320 in the adapter.

10 The power source determination signal may identify a power capability of the external power source is an external automobile DC power source, an external AC power source, or an external airplane DC power source. For example, the power source determination signal may identify that the power adapter is connected to an external airplane DC power source and is limited to a number of watts of output, e.g., 50 or 60 watts of power. Alternatively, the power source

15 determination signal may identify that the power adapter is connected to an external automobile power source, e.g., 90 watts or 100 watts.

The microcontroller 950 may receive the power source determination signal. Based on the received power source determination signal, the microcontroller 950 may extract a character string corresponding to the received power source determination signal from a memory. The

20 memory 954 (see Figs. 9A, 9B, and 10) , as noted before, may store a number of character strings. Alternatively, the memory 954 may store a number of values and the microcontroller 950 may select one of the number of values. Although Fig. 11 does not illustrate that the microcontroller includes the memory 954, receiver 952, and transmitter 956, the microcontroller

950 may incorporate these components. Alternatively, the memory 954, receiver 952, and transmitter 956 may be located in devices outside of the controller 950 (e.g., not incorporated therein). The number of character strings or values may each represent a different power capability of the power adapters which can be coupled to the tip via a cable. Illustratively, one character string or value may represent a 90 watt power adapter, one character string may represent a 130 watt power adapter, one character string may represent a 70 watt power adapter, and one character string may represent that the power adapter has a limited power supply capability, e.g., less than 70 watts.

In an embodiment of the invention, no character string or value may be transmitted if the power adapter cannot generate a certain wattage of power. This may represent that the power adapter and tip cannot be utilized to charge the battery of the electronic device. The microcontroller 950 may transmit the selected character string to the electronic device. A controller 360 in the electronic device may receive the selected character string and may perform a plurality of actions based on the selected character string. For example, if the selected character string identifies that the power adapter has a limited power capability, e.g., less than 50 watts or 70 watts, the controller 360 may place the electronic device in a mode of low power consumptions, e.g., turning off display earlier or not allowing charging of the battery in the electronic device. Under other operating conditions, the character string or value may identify that an AC adapter is the external power source and can provide 130 Watts, and the controller 360 may allow the battery in the electronic device to be charged by the power adapter and place the electronic device in a high power consumption mode, e.g., brightness of screen and hard drive.

Under certain operating conditions, rather than a character string, the microcontroller 950 may have a number of current levels that represent different power capabilities of adapters. Illustratively, in other words, a first current level may represent that the power adapter 340 can supply 130 watts, a second current level may represent that the power adapter 340 can supply 90  
5 watts, a third current level represents that the power adapter 340 can supply 70 watts, and a fourth current level may represent the power adapter 340 supplies less than 70 watts.

While the description above refers to particular embodiments of the present invention, it will be understood that many modifications may be made without departing from the spirit thereof. The accompanying claims are intended to cover such modifications as would fall within  
10 the true scope and spirit of the present invention. The presently disclosed embodiments are therefore to be considered in all respects as illustrative and not restrictive, the scope of the invention being indicated by the appended claims, rather than the foregoing description, and all changes which come within the meaning and range of equivalency of the claims are therefore intended to be embraced therein.

## WHAT IS CLAIMED IS:

1. An adapter device, comprising:
  - a DC/DC adapter, located in an external casing to a portable com-  
5 puter having a power supply, to receive DC power from an external DC power source, and output a regulated DC voltage ( $V_{out}$ ) to the portable computer; and
  - DC source determination circuitry, in the adapter device, to receive  
10 the DC power from the external DC power source and compare a magnitude of a voltage of the DC power with a reference magnitude of a reference voltage ( $V_{ref}$ ) in order to determine what type of external DC power source is supplying DC power,  
15 wherein when the magnitude of the voltage of the DC power is greater than the reference magnitude, a data signal ( $V_{data}$ ) having a first value indicative of the external DC power source being an airplane power source is output to the portable com-  
puter along with the regulated DC voltage, and when the  
20 magnitude of the voltage of the DC power is less than the reference magnitude, the data signal ( $V_{data}$ ) having a second value indicative of the external DC power source being an automobile power source is output to the portable computer along with the regulated DC voltage.
- 25 2. The adapter device according to claim 1, the magnitude of the DC power being in a range between about 11.0 Volts and about 14.1 Volts.

3. The adapter device according to claim 1, the magnitude of the DC power being in a range between about 14.5 Volts and about 15.5 Volts.
- 5 4. The adapter device according to claim 1, further including an AC/DC adapter to receive AC input power and convert the AC input power to an additional DC power signal.
- 10 5. The adapter device according to claim 1, the data ( $V_{data}$ ) signal being selected from the group consisting of: (a) a transmission of a discrete bit, (b) a transmission of a data signal having multiple bits, (c) an analog signal, and (d) an analog voltage.
- 15 6. A method comprising:  
 receiving, at an adapter which is an external casing separate from a portable computer, DC power from a DC power source and outputting a regulated DC voltage ( $V_{out}$ ) from the adapter to the portable computer;  
 comparing, in the adapter, a magnitude of a voltage of the DC power with a reference magnitude of a reference voltage ( $V_{ref}$ ) to identify what type of DC power source is supplying the DC power to the adapter;  
 outputting a data signal ( $V_{data}$ ) having a first value along with the regulated DC voltage to the portable computer when the magnitude of the voltage of the DC power is greater than the reference magnitude which identifies that the DC power source is a first power source; and  
 20 outputting the data signal ( $V_{data}$ ) having a second value along with the regulated DC voltage to the portable computer when the mag-  
 25

nititude of the voltage of the DC power is less than the reference magnitude which identifies that the DC power source is a second power source.

- 5 7. The method according to claim 6, wherein the first power source is an airplane power source and the second power source is an automobile power source.
- 10 8. The method according to claim 6, the magnitude of the DC power being in a range between about 11.0 Volts and about 14.1 Volts.
9. The method according to claim 6, the magnitude of the DC power being in a range of between about 14.5 Volts and about 15.5 Volts.
- 15 10. The method according to claim 6, the adapter further including an AC/DC converter capable of receiving AC input and converting the AC input into a DC voltage.
- 20 11. The method according to claim 6, the data signal  $V_{data}$  being selected from the group consisting of: (a) a transmission of a discrete bit, (b) a transmission of a data signal having multiple bits, (c) an analog signal, and (d) an analog voltage.
- 25 12. A power supply system, comprising:  
 an adapter device to receive DC power from an external DC power source, and to output a regulated DC voltage, the adapter device including:  
 DC source determination circuitry to receive the DC power from the external DC power source and compare, in the adapter device,

a magnitude of a voltage of the DC power with a reference magnitude of a reference voltage in order to determine a type of external DC power source that is supplying the DC power, wherein when the magnitude of the voltage of the DC power is  
5 greater than the reference magnitude, a data signal having a first value indicative of the external DC power source being a first power source is output along with the regulated DC voltage, and when the magnitude of the voltage of the DC power is less than the reference magnitude, the data signal  
10 having a second value indicative of the external DC power source being a second power source is output along with the regulated DC voltage; and  
a portable computer having control circuitry to receive the data signal and the regulated DC voltage.

15

13. The power supply system according to claim 12, wherein when the data signal has the first value, the portable computer operates in a first mode where a battery charging circuitry is disabled, and when the data signal has the second value, the battery charging circuitry is  
20 enabled.

20

14. The power supply system according to claim 12, the magnitude of the DC power being in a range between about 11.0 Volts and about 14.1 Volts.

25

15. The power supply system according to claim 12, the magnitude of the DC power being in a range between about 14.5 Volts and about 15.5 Volts.



16. The power supply system according to claim 12, the adapter device further including an AC/DC adapter to receive AC input power and convert the AC input power to an additional DC power signal.
- 5 17. The power supply system according to claim 12, the data signal being selected from the group consisting of: (a) a transmission of a discrete bit, (b) a transmission of a data signal having multiple bits, (c) an analog signal, and (d) an analog voltage.
- 10 18. The power supply system of claim 12, wherein the first power source is an airplane power source and the second power source is an automobile power source.

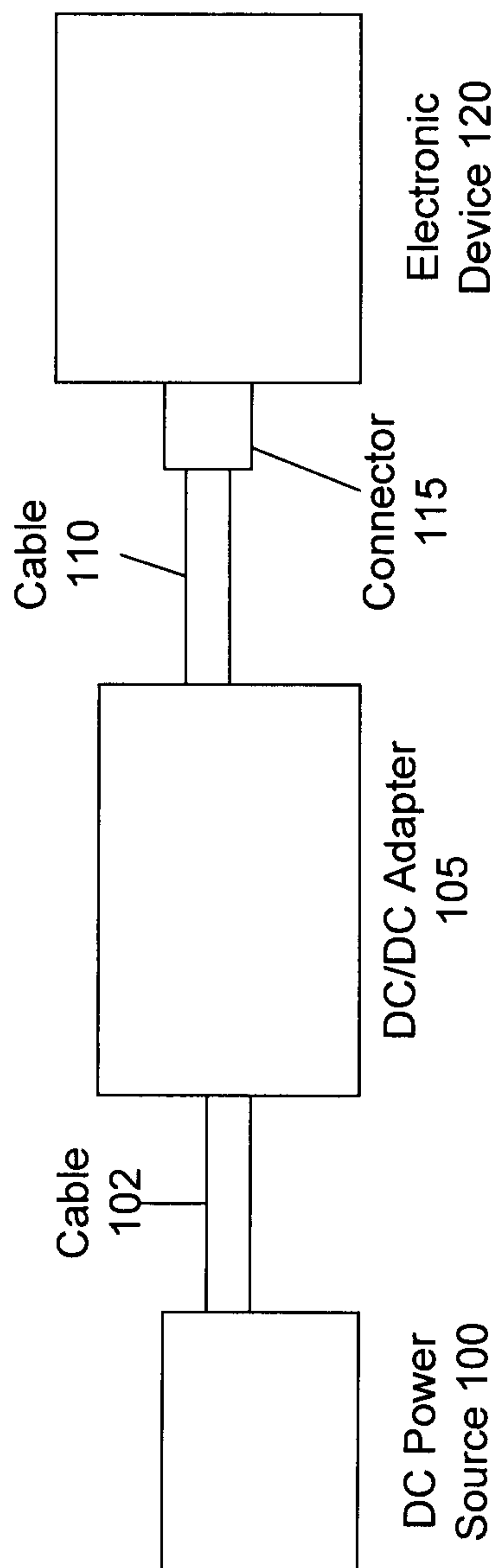

Fig. 1 (Prior Art)

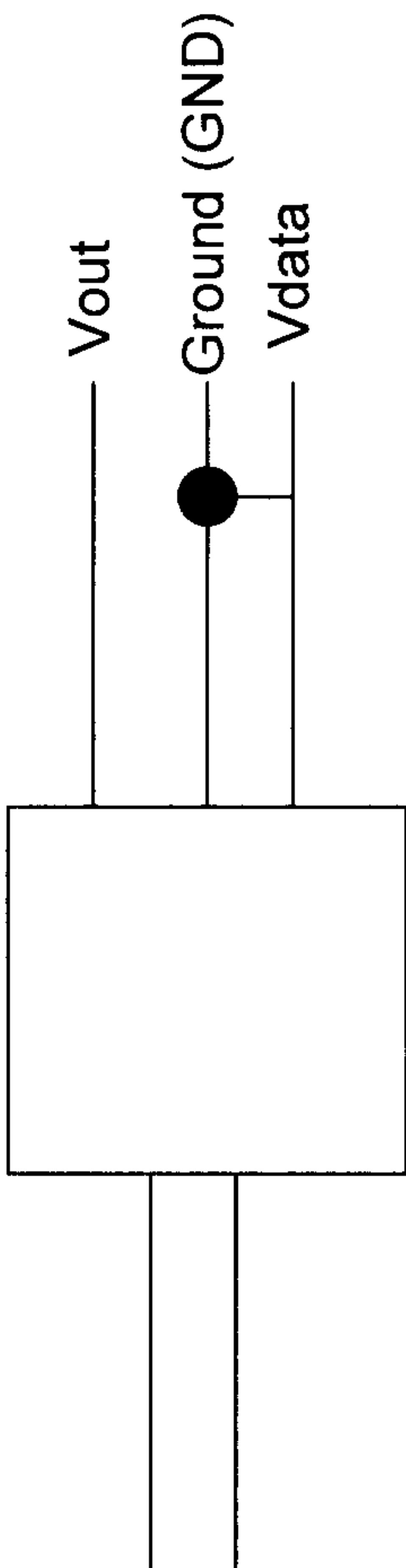

Fig. 2A

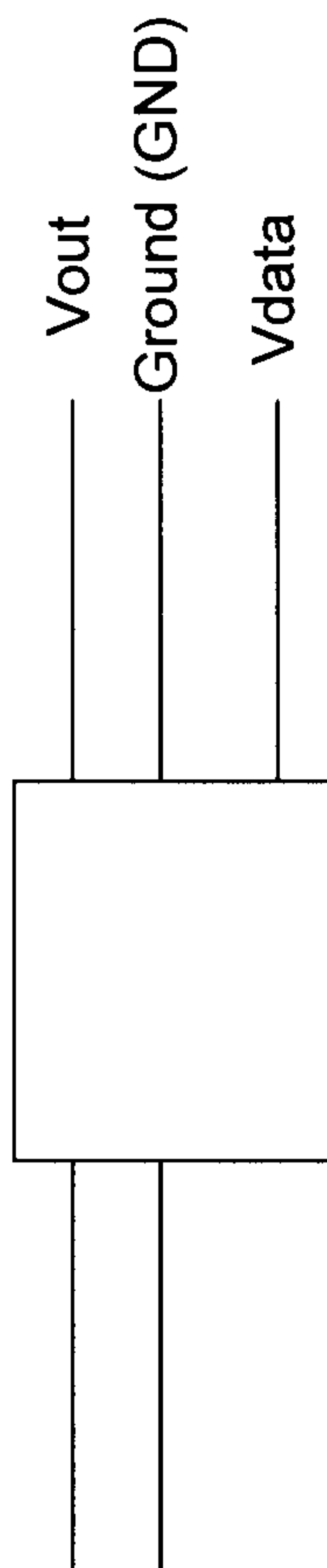

Fig. 2B

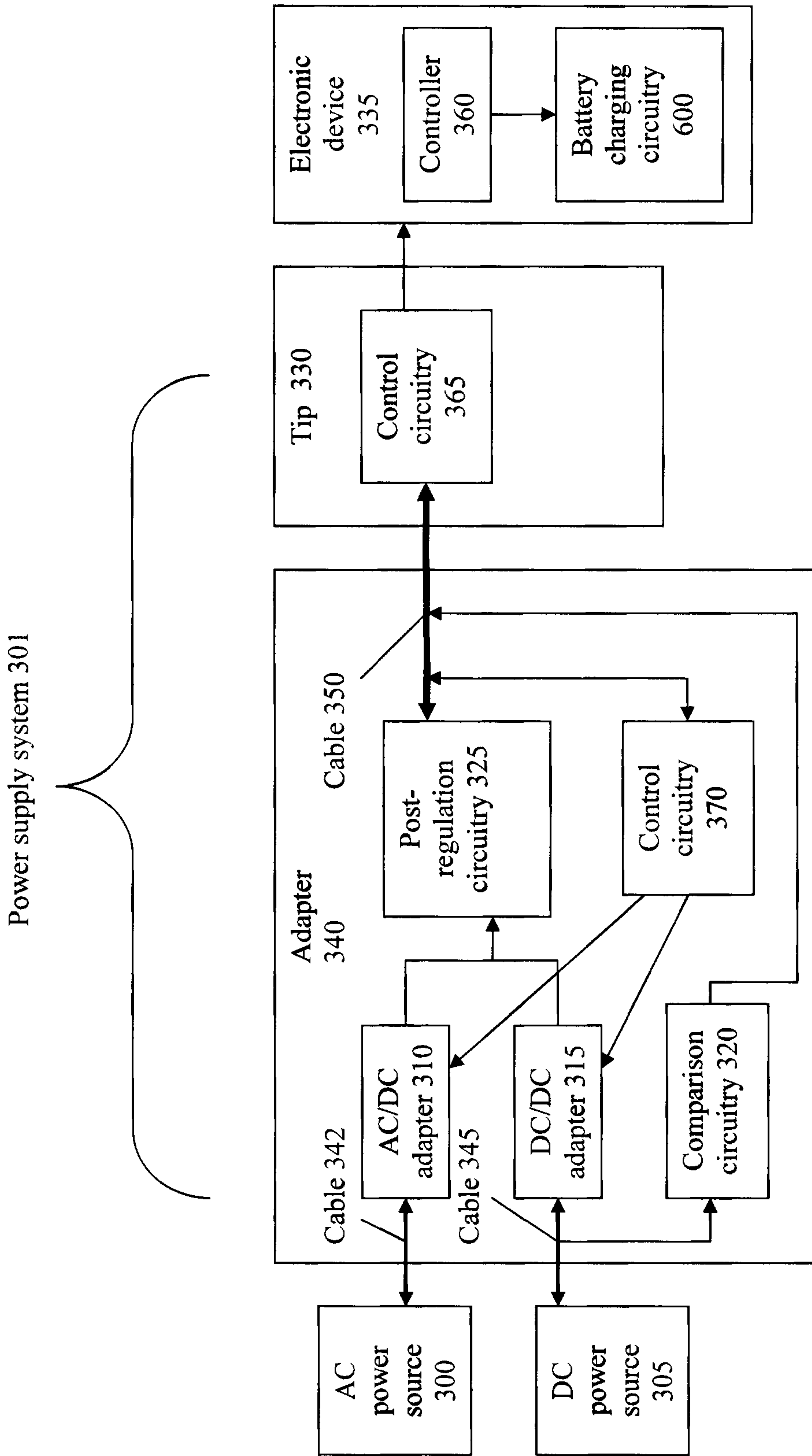
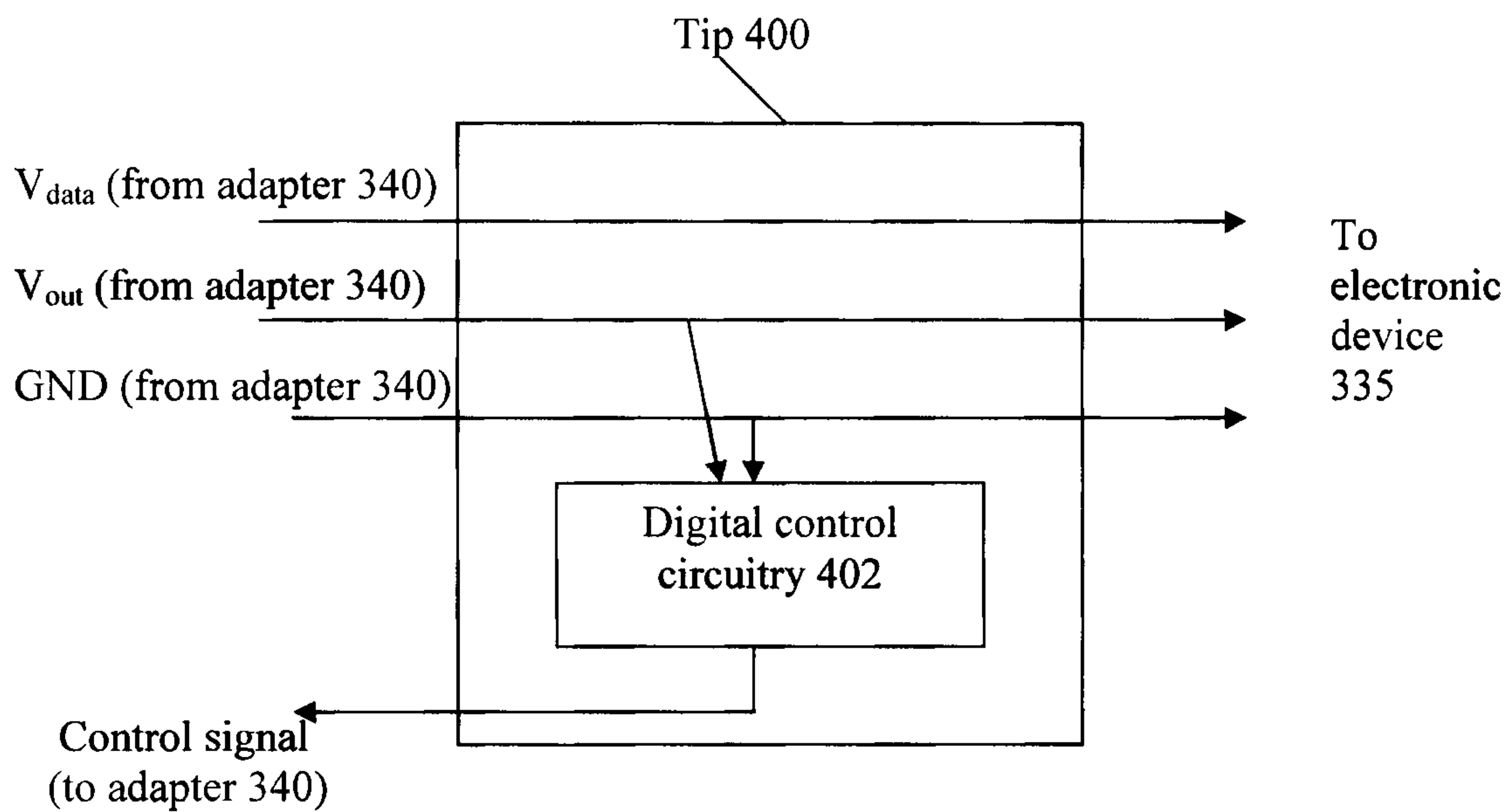
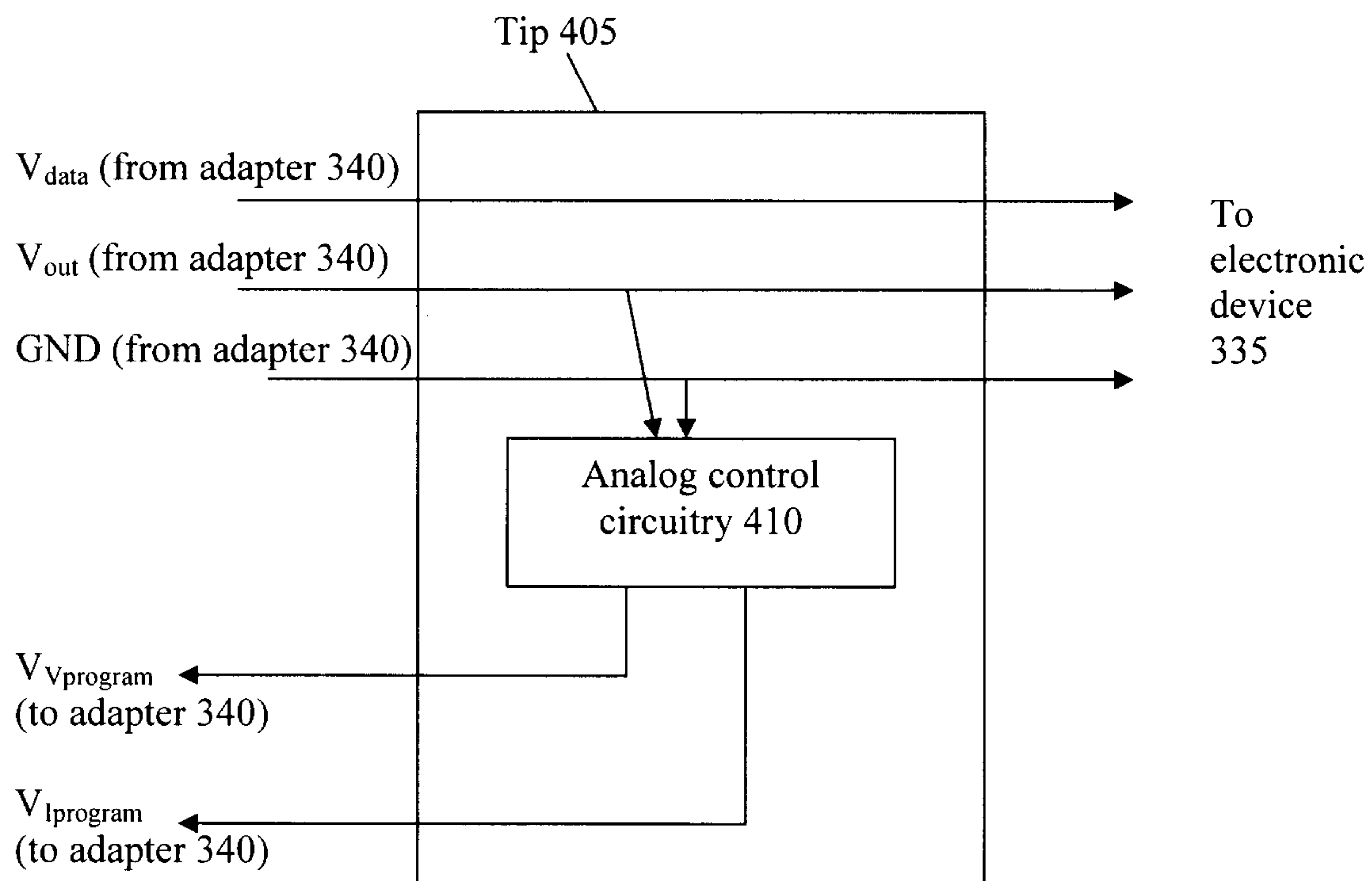

FIG. 3



**FIG. 4A**



**FIG. 4B**

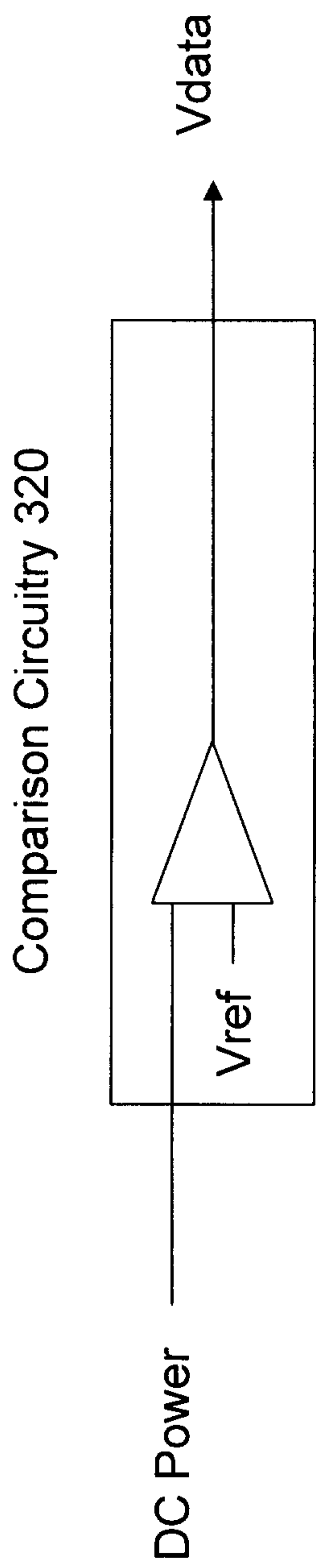

Fig. 5A

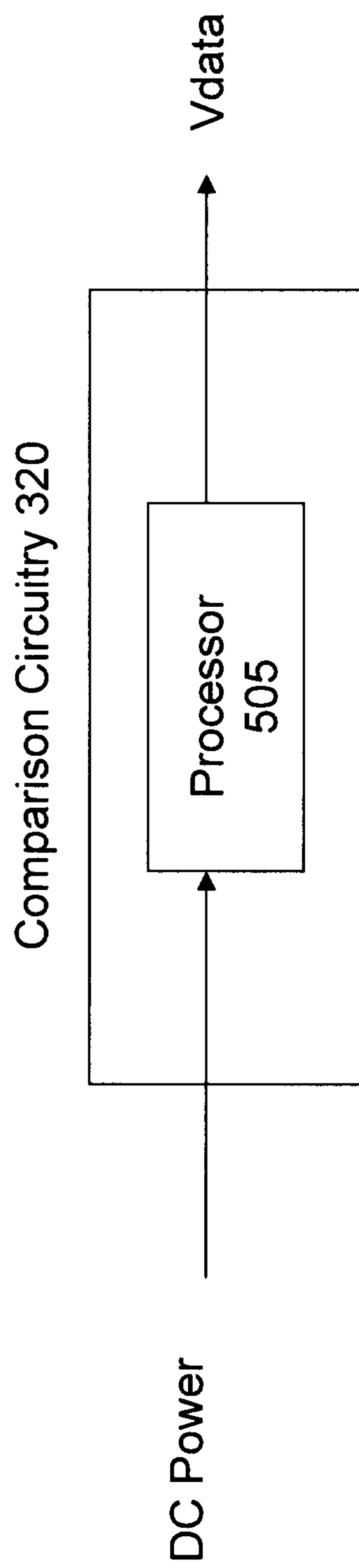

Fig. 5B

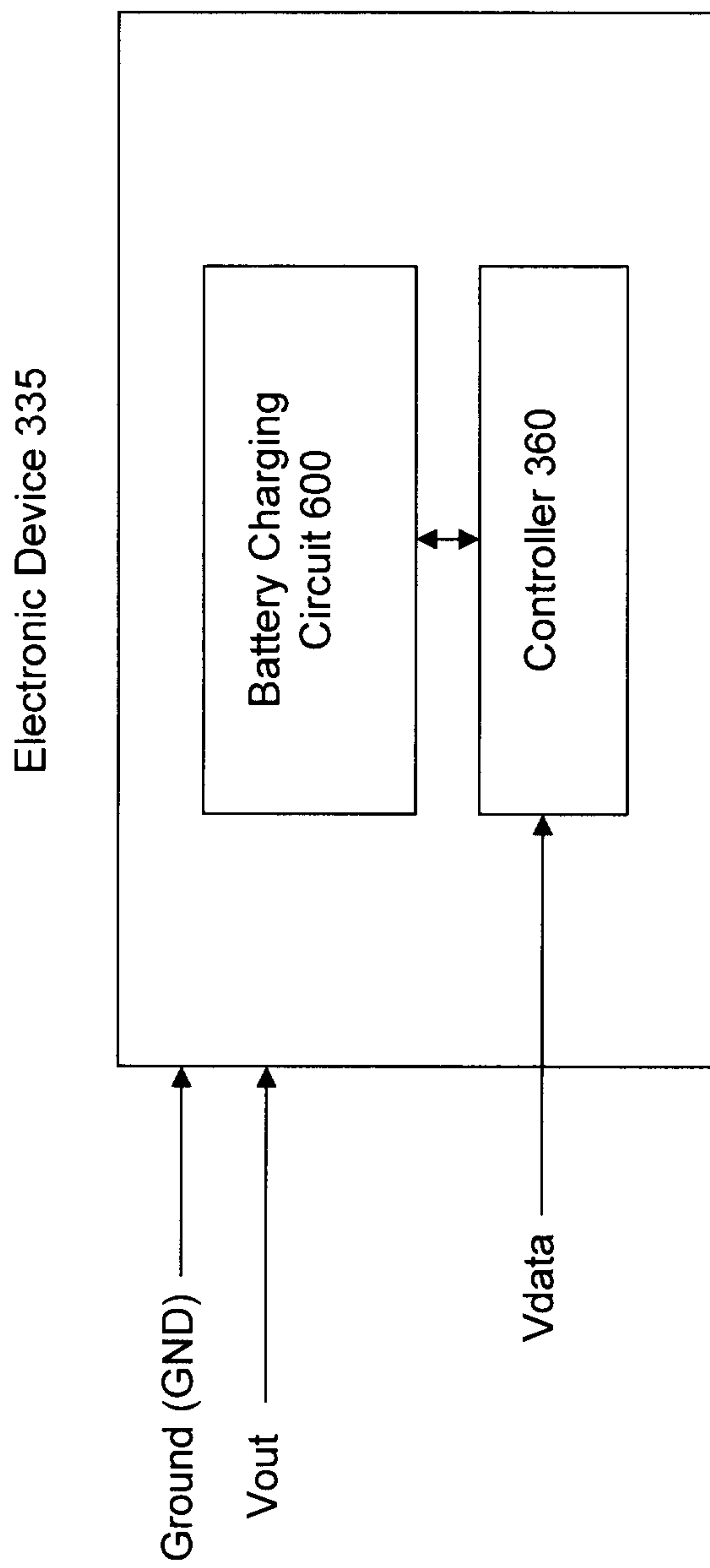

Fig. 6



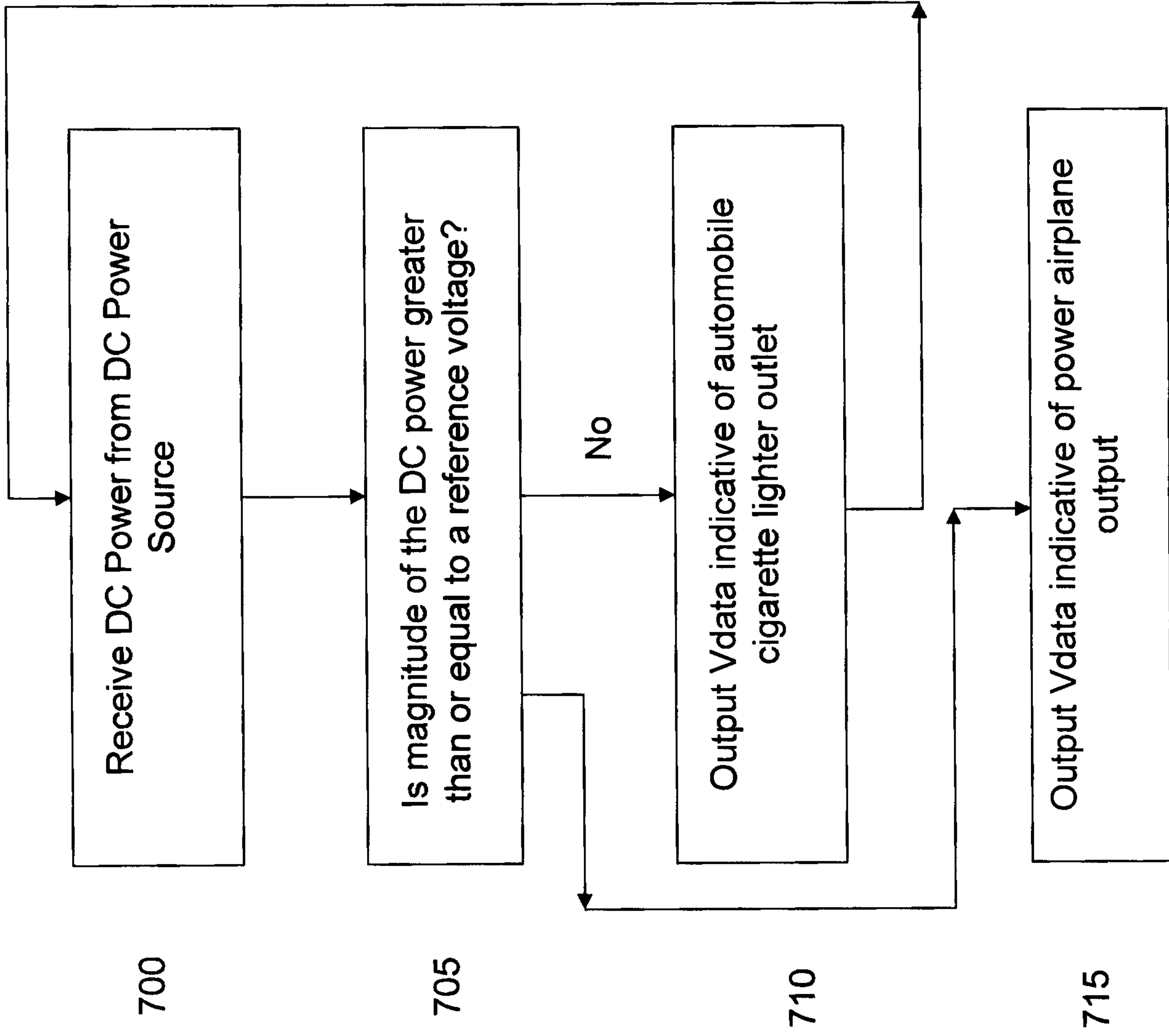

Fig. 7A

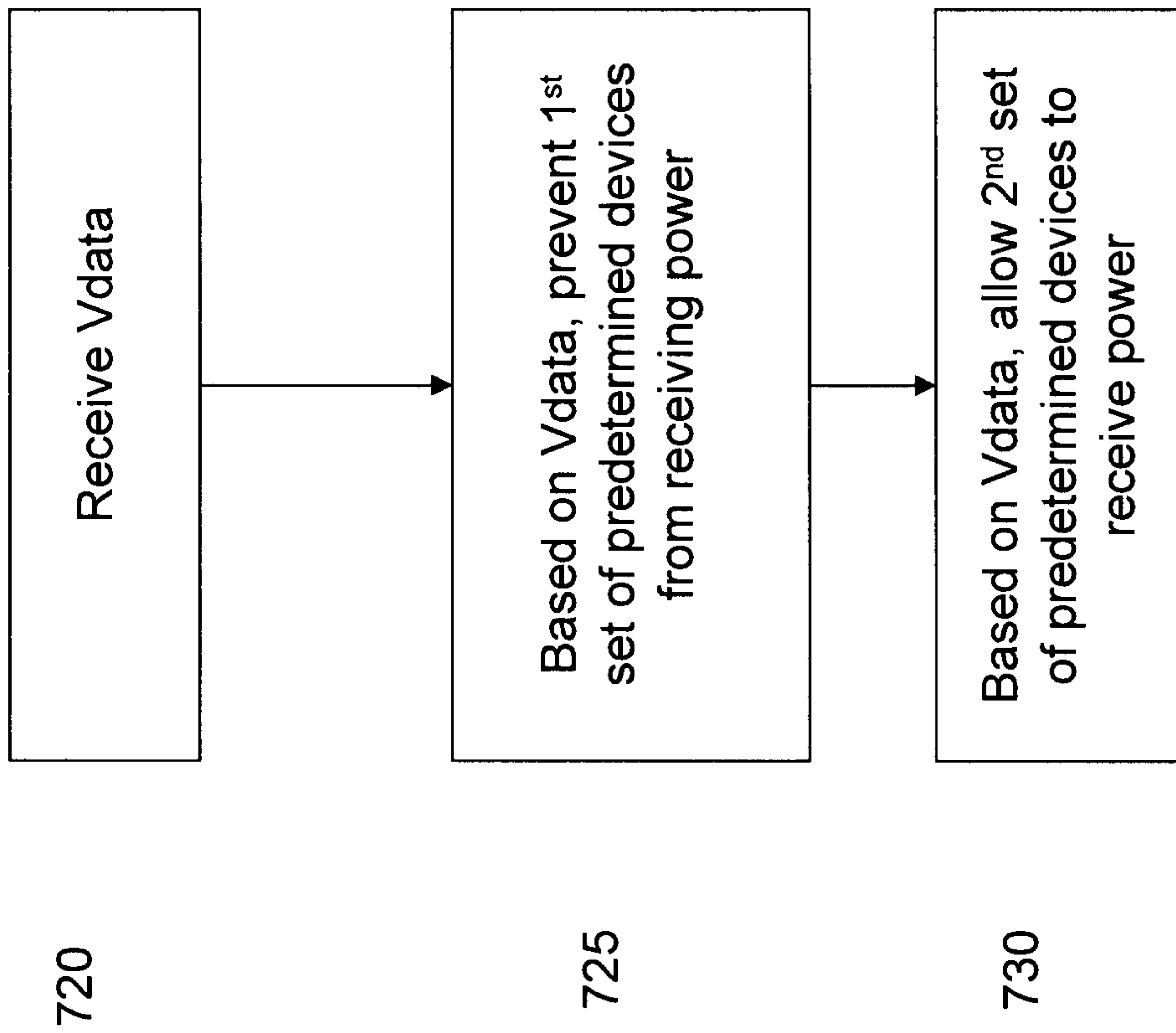

Fig. 7B

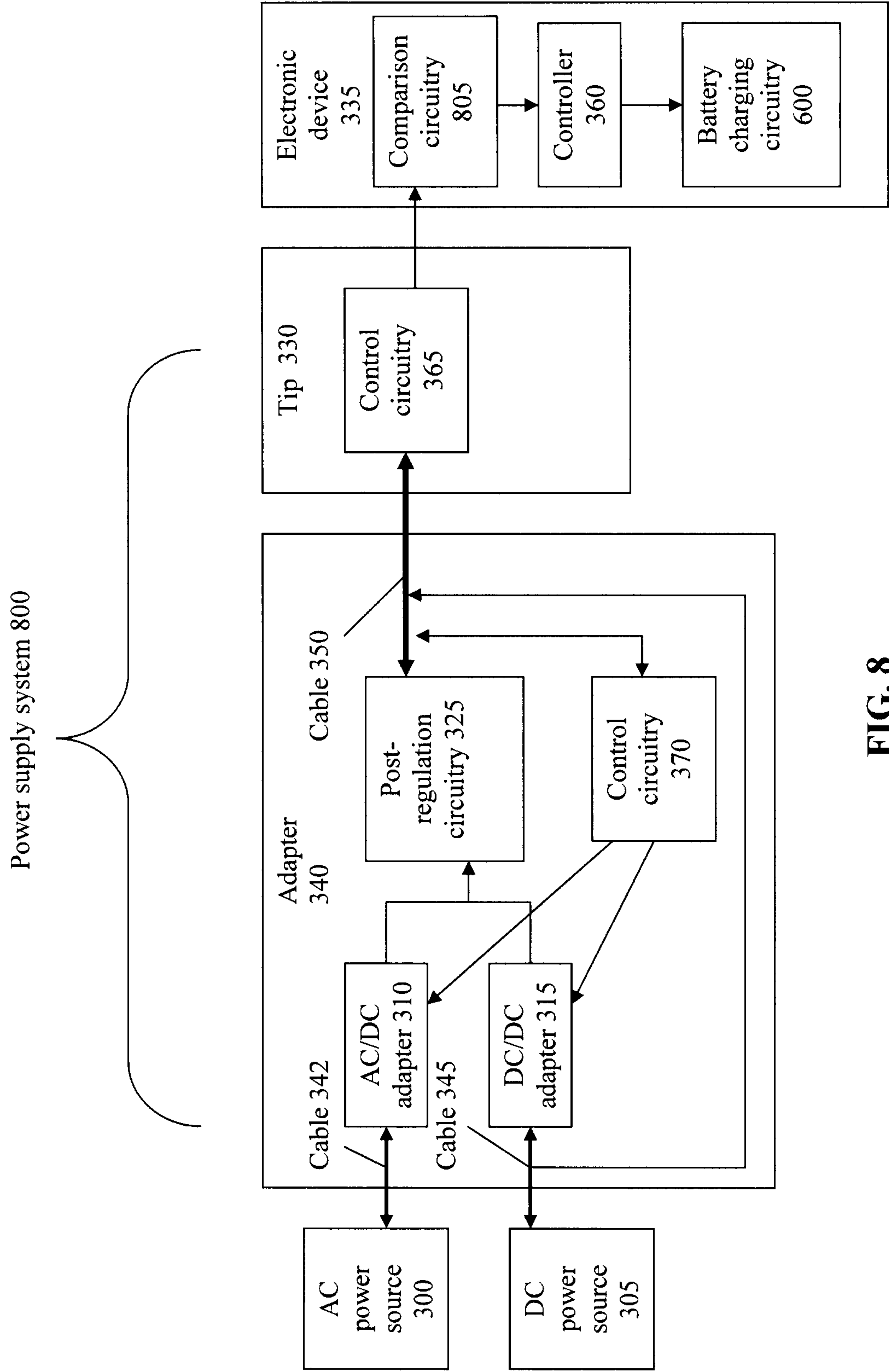
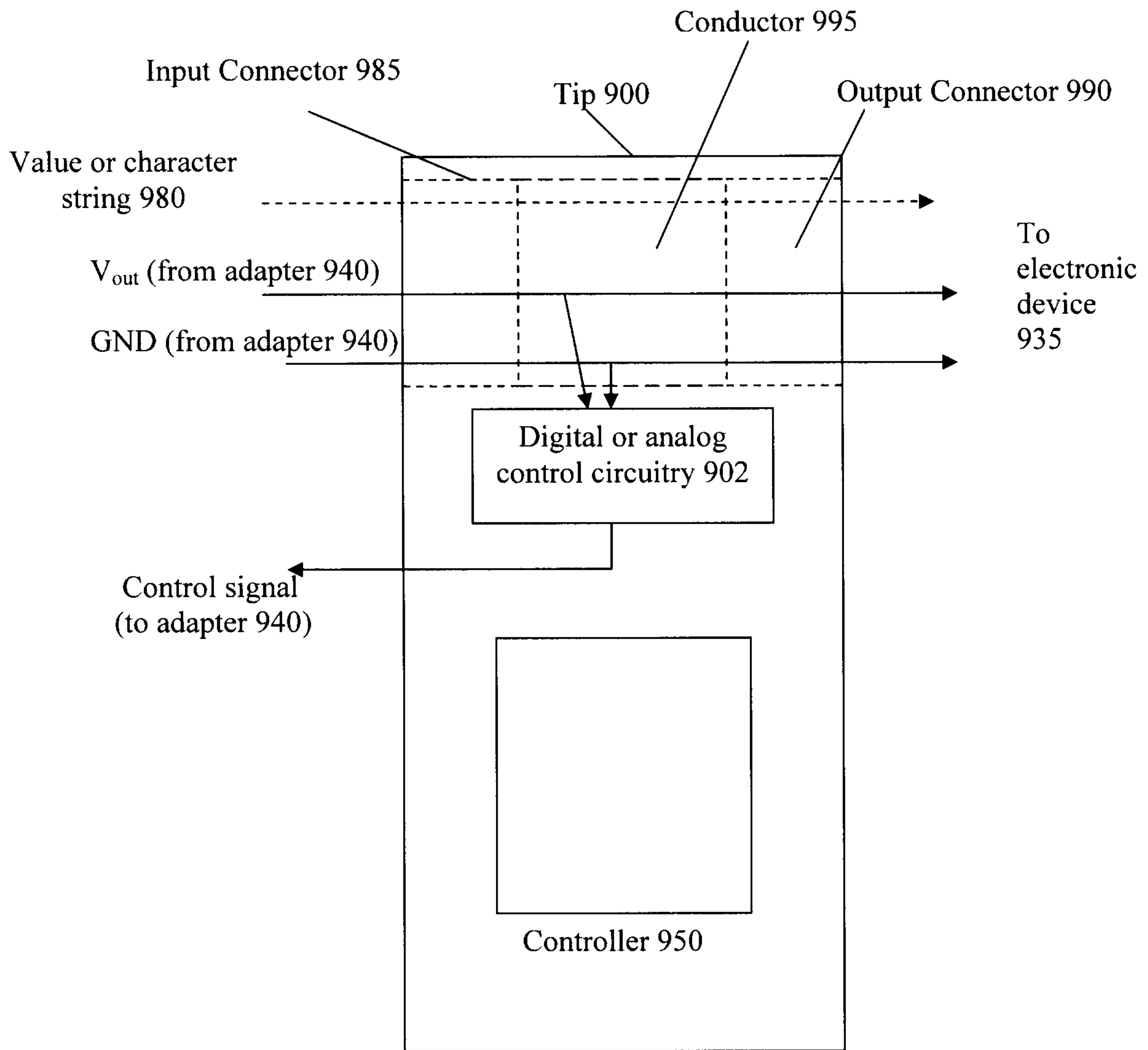
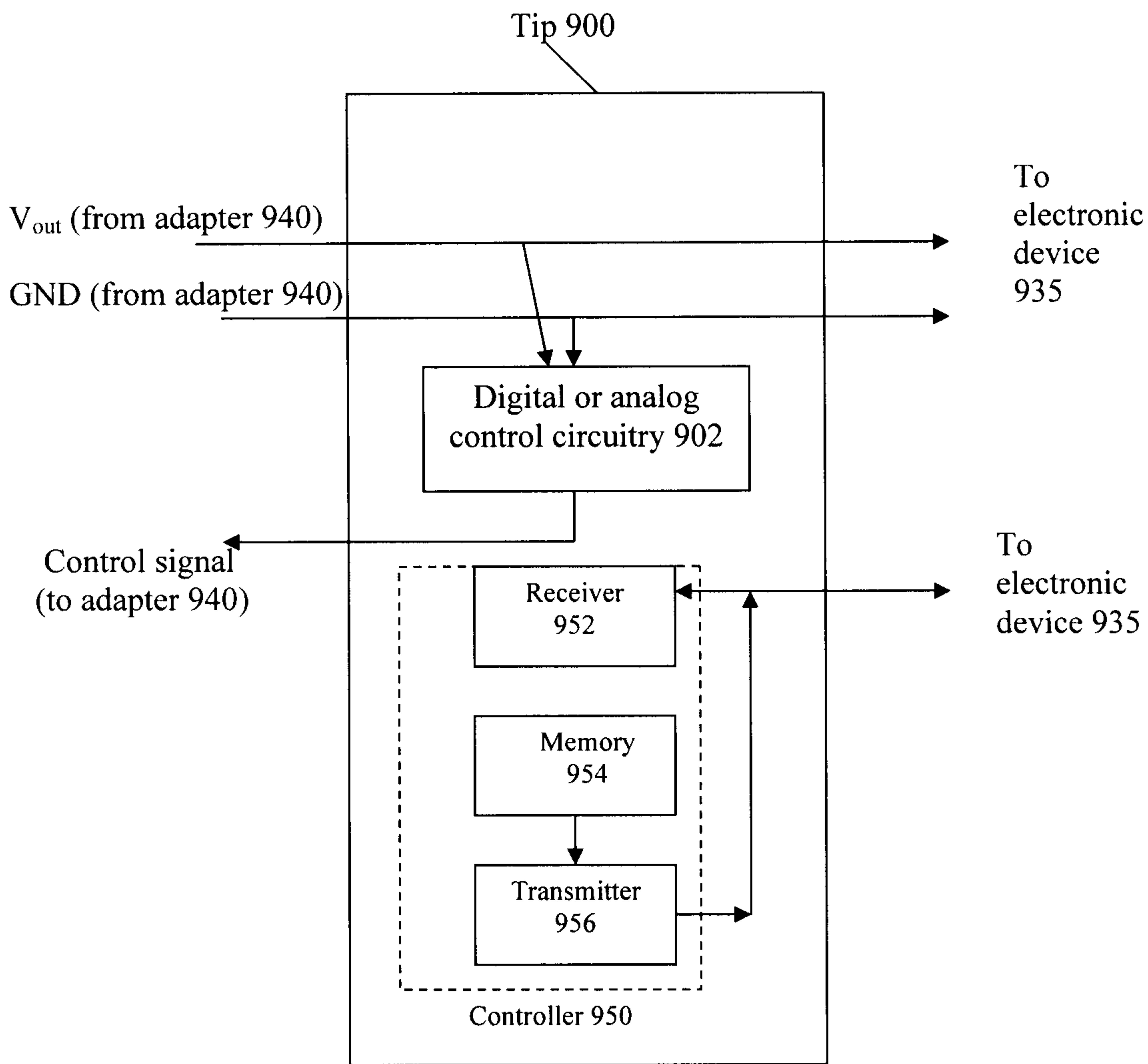

FIG. 8



**FIG. 9A**



**FIG. 9B**

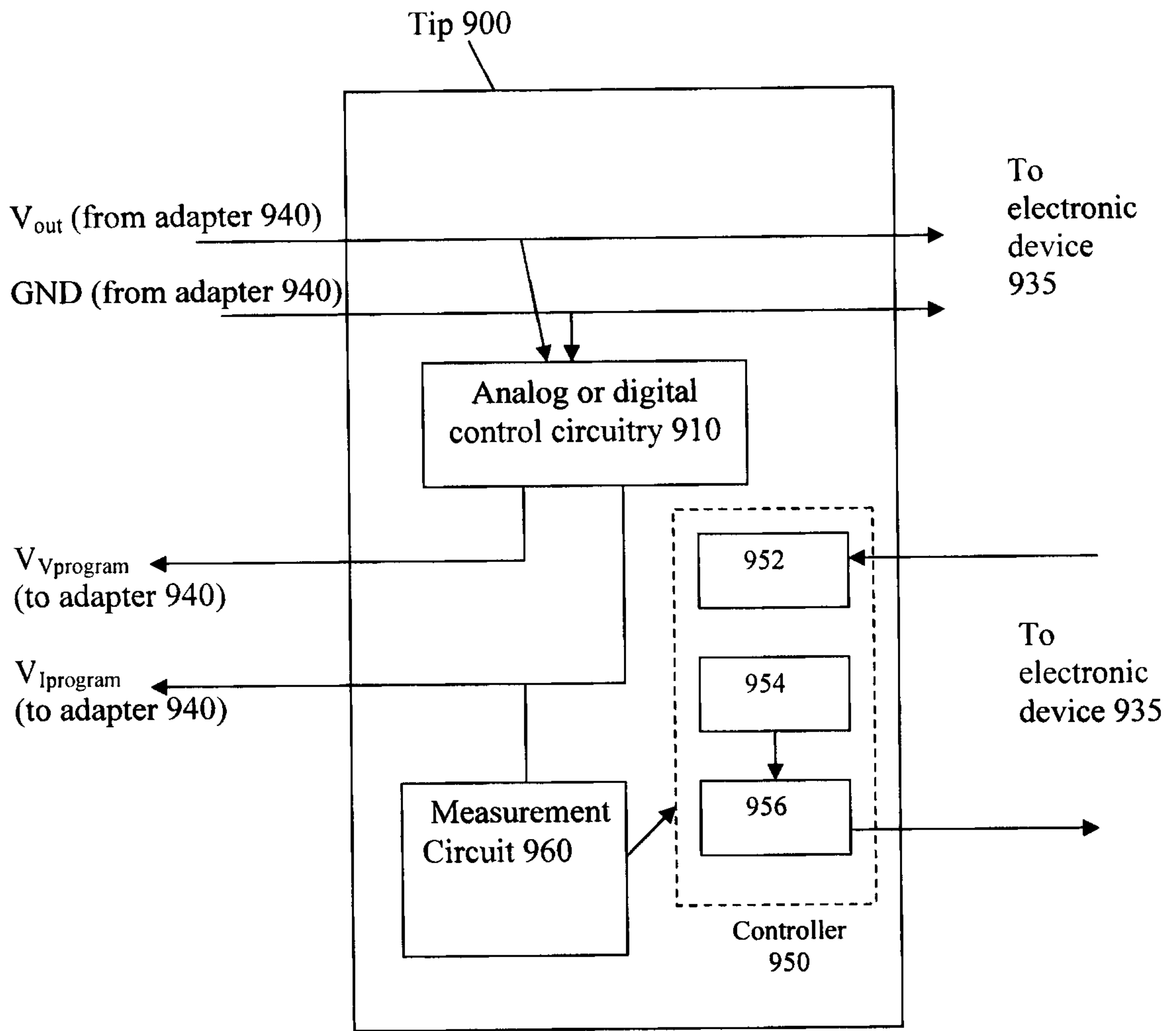

**FIG. 10**

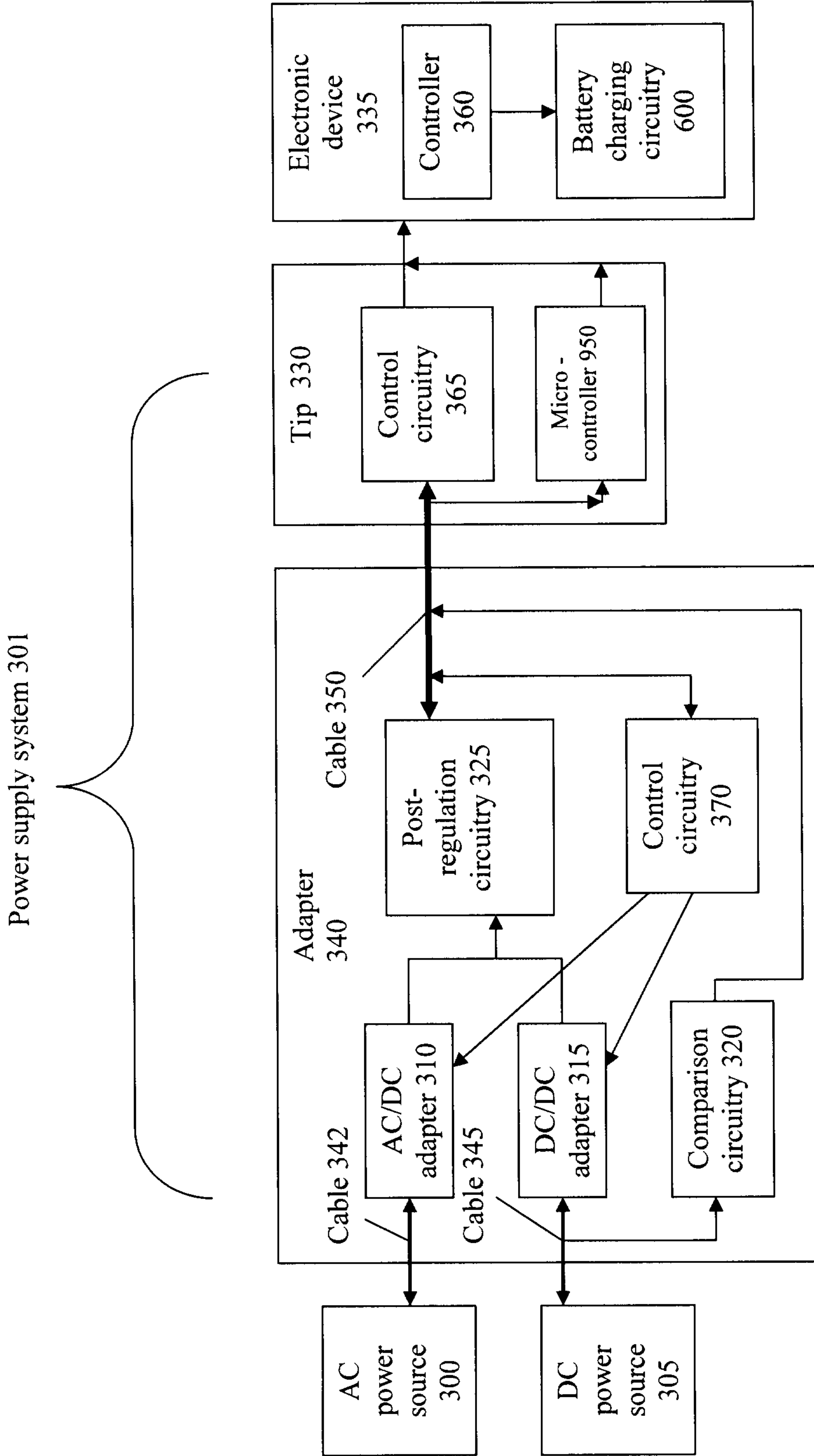

FIG. 11

Power supply system 301

