



(72) EDWARDS, STUART D., US

(71) CONWAY-STUART MEDICAL, INC., US

(51) Int.Cl.⁶ A61B 17/39

(30) 1998/01/14 (09/007,237) US

(54) **APPAREIL ELECTROCHIRURGICAL DE TRAITEMENT DU
REFLUX GASTRO-OESOPHAGIEN (RGO) ET METHODE**

(54) **ELECTROSURGICAL APPARATUS FOR TREATING
GASTROESOPHAGEAL REFLUX DISEASE (GERD) AND
METHOD**

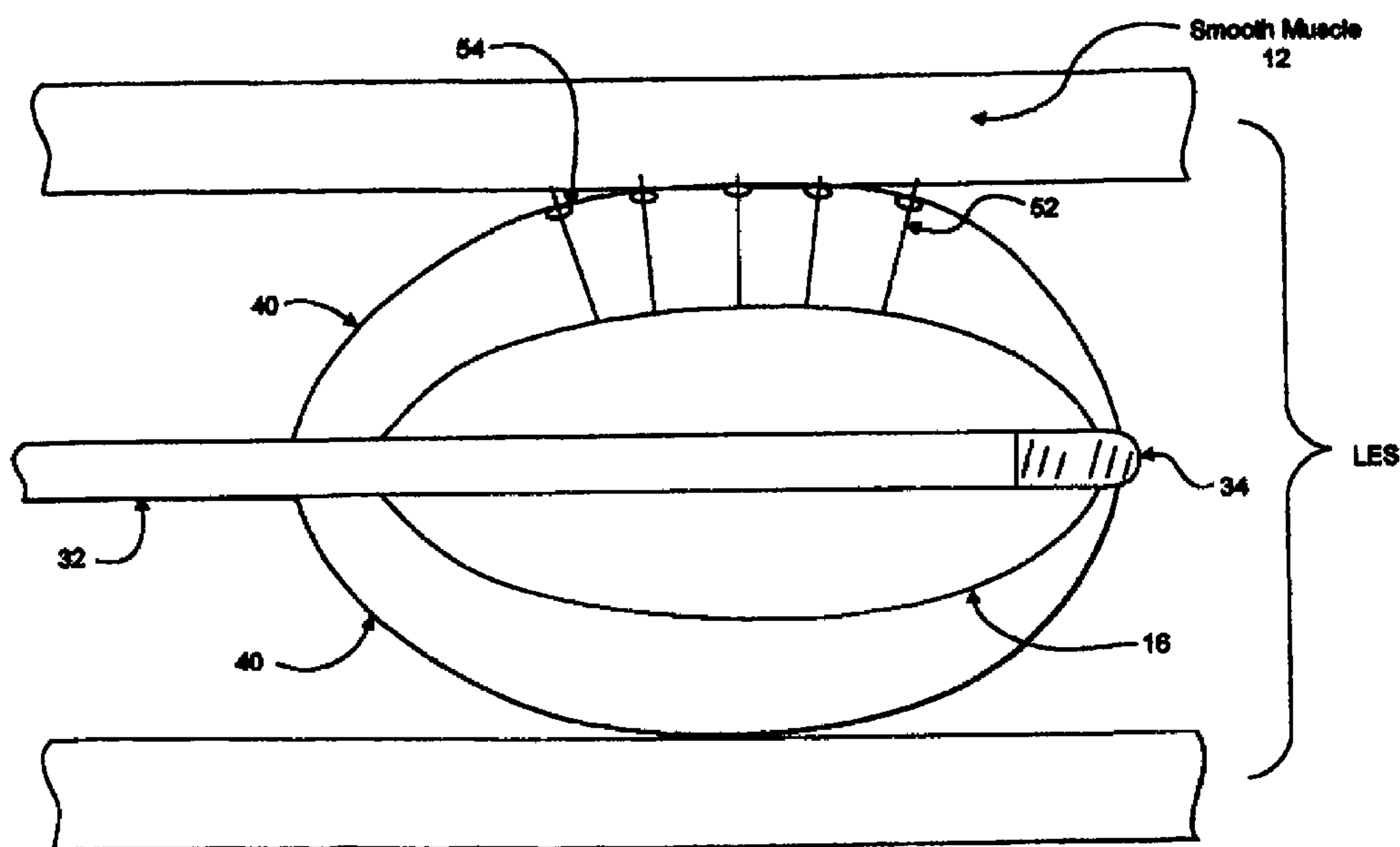

(57) Cet appareil comprend un élément gonflable de dimensions telles qu'il peut être positionné dans un muscle sphincter. Un dispositif de décharge d'énergie est positionné sur une surface de l'élément gonflable et sert à décharger une énergie suffisante pour créer des lésions à l'intérieur du muscle sphincter. Lorsque l'élément gonflable est enlevé du muscle sphincter, le muscle sphincter revient à sa configuration fermée ou contractée.

(57) An apparatus includes an expandable member. The expandable member is sized to be positionable in a sphincter. An energy delivery device is positioned on a surface of the expandable member. The energy delivery device has a configuration that provides sufficient energy delivery to create lesions in the interior of the sphincter. When the expandable member is removed from the sphincter, the sphincter returns to its closed or contracted configuration.



PCT

WORLD INTELLECTUAL PROPERTY ORGANIZATION
International Bureau

INTERNATIONAL APPLICATION PUBLISHED UNDER THE PATENT COOPERATION TREATY (PCT)

(51) International Patent Classification ⁶ : A61B 17/39	A1	(11) International Publication Number: WO 99/35986 (43) International Publication Date: 22 July 1999 (22.07.99)
<p>(21) International Application Number: PCT/US99/00693</p> <p>(22) International Filing Date: 13 January 1999 (13.01.99)</p> <p>(30) Priority Data: 09/007,237 14 January 1998 (14.01.98) US</p> <p>(63) Related by Continuation (CON) or Continuation-in-Part (CIP) to Earlier Application US 09/007,237 (CON) Filed on 14 January 1998 (14.01.98)</p> <p>(71) Applicant (for all designated States except US): CONWAY-STUART MEDICAL, INC. [US/US]; 735 Palomar Avenue, Sunnyvale, CA 94086 (US).</p> <p>(72) Inventor; and (75) Inventor/Applicant (for US only): EDWARDS, Stuart, D. [US/US]; 658 Westridge Drive, Portola Valley, CA 94028 (US).</p> <p>(74) Agent: DAVIS, Paul; Wilson Sonsini Goodrich & Rosati, 650 Page Mill Road, Palo Alto, CA 94304-1050 (US).</p>	<p>(81) Designated States: AL, AM, AT, AU, AZ, BA, BB, BG, BR, BY, CA, CH, CN, CU, CZ, DE, DK, EE, ES, FI, GB, GD, GE, GH, GM, HR, HU, ID, IL, IN, IS, JP, KE, KG, KP, KR, KZ, LC, LK, LR, LS, LT, LU, LV, MD, MG, MK, MN, MW, MX, NO, NZ, PL, PT, RO, RU, SD, SE, SG, SI, SK, SL, TJ, TM, TR, TT, UA, UG, US, UZ, VN, YU, ZW, ARIPO patent (GH, GM, KE, LS, MW, SD, SZ, UG, ZW), Eurasian patent (AM, AZ, BY, KG, KZ, MD, RU, TJ, TM), European patent (AT, BE, CH, CY, DE, DK, ES, FI, FR, GB, GR, IE, IT, LU, MC, NL, PT, SE), OAPI patent (BF, BJ, CF, CG, CI, CM, GA, GN, GW, ML, MR, NE, SN, TD, TG).</p> <p>Published With international search report. Before the expiration of the time limit for amending the claims and to be republished in the event of the receipt of amendments.</p>	

(54) Title: ELECTROSURGICAL APPARATUS FOR TREATING GASTROESOPHAGEAL REFLUX DISEASE (GERD) AND METHOD

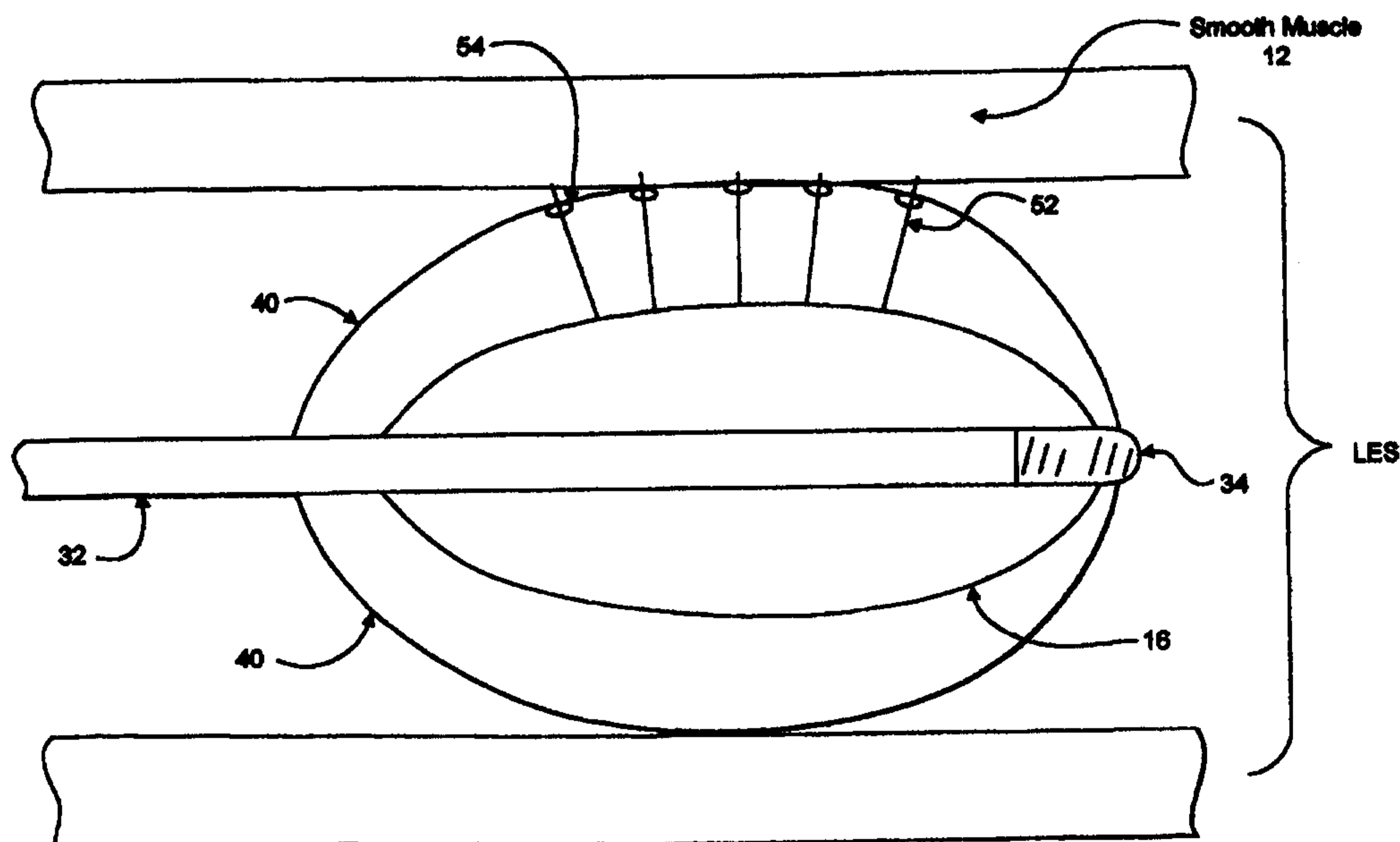

(57) Abstract

An apparatus includes an expandable member. The expandable member is sized to be positionable in a sphincter. An energy delivery device is positioned on a surface of the expandable member. The energy delivery device has a configuration that provides sufficient energy delivery to create lesions in the interior of the sphincter. When the expandable member is removed from the sphincter, the sphincter returns to its closed or contracted configuration.

WO 99/35986

PCT/US99/00693

ELECTROSURGICAL APPARATUS FOR TREATING GASTROESOPHAGEAL REFLUX DISEASE (GERD) AND METHOD**BACKGROUND OF THE INVENTION****Cross-Related Applications**

5 This application is a continuation-in-part of U.S. Patent Application Serial
No. 08/731,372, filed October 11, 1996, which is a continuation-in-part of U.S.
Patent Application Serial No. 08/319,373, filed October 6, 1994, which is a
continuation-in-part of U.S. Application No. 08/286,862, filed August 4, 1994,
which is a continuation-in-part of U.S. Patent Application Serial No. 08/272,162,
10 filed July 7, 1994, which is a continuation-in-part of U.S. Patent Application Serial
No. 08/265,459, filed June 24, 1994, and is related to concurrently filed Application
entitled "GERD Treatment Apparatus and Method" identified as Attorney Docket
14800-748, all with named inventor Stuart D. Edwards, and all of which are
incorporated herein by reference.

Field of the Invention

15 This invention relates generally to an apparatus and method for the
treatment of sphincters, and more specifically to an apparatus and method that treat
esophageal sphincters.

Description of Related Art

20 Gastroesophageal reflux disease (GERD) is a common gastroesophageal
disorder in which the stomach contents are ejected into the lower esophagus due to
a dysfunction of the lower esophageal sphincter (LES). These contents are highly
acidic and potentially injurious to the esophagus resulting in a number of possible
complications of varying medical severity. The reported incidence of GERD in the
U.S. is as high as 10% of the population (Castell DO; Johnston BT:

Gastroesophageal Reflux Disease: Current Strategies For Patient Management.
Arch Fam Med, 5(4):221-7; (1996 April).

Acute symptoms of GERD include heartburn, pulmonary disorders and chest pain. On a chronic basis, GERD subjects the esophagus to ulcer formation, or esophagitis and may result in more severe complications including esophageal obstruction, significant blood loss and perforation of the esophagus. Severe esophageal ulcerations occur in 20-30% of patients over age 65. Moreover, GERD causes adenocarcinoma, or cancer of the esophagus, which is increasing in incidence faster than any other cancer (Reynolds JC: *Influence Of Pathophysiology, Severity, And Cost On The Medical Management Of Gastroesophageal Reflux Disease.* Am J Health Syst Pharm, 53(22 Suppl 3):S5-12 (1996 Nov 15)).

Current drug therapy for GERD includes histamine receptor blockers which reduce stomach acid secretion and other drugs which may completely block stomach acid. However, while pharmacologic agents may provide short term relief, they do not address the underlying cause of LES dysfunction.

Invasive procedures requiring percutaneous introduction of instrumentation into the abdomen exist for the surgical correction of GERD. One such procedure, Nissen fundoplication, involves constructing a new "valve" to support the LES by wrapping the gastric fundus around the lower esophagus. Although the operation has a high rate of success, it is an open abdominal procedure with the usual risks of abdominal surgery including: postoperative infection, herniation at the operative site, internal hemorrhage and perforation of the esophagus or of the cardia. In fact, a recent 10 year, 344 patient study reported the morbidity rate for this procedure to be 17% and mortality 1% (Urschel, JD: *Complications Of Antireflux Surgery,* Am J Surg 166(1): 68-70; (1993 July)). This rate of complication drives up both medical cost and convalescence period for the procedure and may exclude portions of certain patient populations (e.g., the elderly and immuno-compromised).

Efforts to perform Nissen fundoplication by less invasive techniques have resulted in the development of laparoscopic Nissen fundoplication. Laparoscopic Nissen fundoplication, reported by Dallemagne et al. *Surgical Laparoscopy and Endoscopy*, Vol. 1, No. 3, (1991), pp. 138-43 and by Hindler et al. *Surgical Laparoscopy and Endoscopy*, Vol. 2, No. 3, (1992), pp. 265-272, involves

5 essentially the same steps as Nissen fundoplication with the exception that surgical manipulation is performed through a plurality of surgical cannula introduced using trocars inserted at various positions in the abdomen.

Another attempt to perform fundoplication by a less invasive technique is reported in U.S. Patent No. 5,088,979. In this procedure, an invagination device containing a plurality of needles is inserted transorally into the esophagus with the needles in a retracted position. The needles are extended to engage the esophagus and fold the attached esophagus beyond the gastroesophageal junction. A remotely operated stapling device, introduced percutaneously through an operating channel

10 in the stomach wall, is actuated to fasten the invaginated gastroesophageal junction to the surrounding involuted stomach wall.

Yet another attempt to perform fundoplication by a less invasive technique is reported in US Patent No. 5,676,674. In this procedure, invagination is done by a jaw-like device and fastening of the invaginated gastroesophageal junction to the fundus of the stomach is done via a transoral approach using a remotely operated fastening device, eliminating the need for an abdominal incision. However, this procedure is still traumatic to the LES and presents the postoperative risks of gastroesophageal leaks, infection and foreign body reaction, the latter two sequela resulting when foreign materials such as surgical staples are implanted in the body.

20

While the methods reported above are less invasive than an open Nissen fundoplication, some still involve making an incision into the abdomen and hence the increased morbidity and mortality risks and convalescence period associated with abdominal surgery. Others incur the increased risk of infection associated with placing foreign materials into the body. All involve trauma to LES and the risk of leaks developing at the newly created gastroesophageal junction.

25

30

There is a need in the art for a less invasive GERD treatment apparatus that does not require major surgical intervention or require the introduction of foreign materials into the body. Yet another need exists for a method of treating GERD that does not involve the medical risks of leakage and infection developing at an artificially created gastroesophageal junction. Yet another need exists for an apparatus that treats GERD with minimum trauma to the LES.

SUMMARY OF THE INVENTION

Accordingly, an object of the invention is to provide an apparatus and method for the treatment of GERD.

Another object of the invention is to provide an apparatus and method to treat GERD using minimally invasive surgical methods such as non-percutaneous methods.

Yet another object of the invention is to provide an apparatus and method to treat the esophageal sphincters using minimally invasive surgical methods.

Another object of the invention is to provide an apparatus and method to tighten the LES.

A further other object of the invention is to provide an apparatus and method to reduce the frequency of spontaneous relaxation and opening of the LES.

Yet another object of the invention is to provide an apparatus and method to reduce the frequency and severity of gastroesophageal reflux events.

These and other objects of the invention are provided in an apparatus with an expandable member sized to be positionable in a sphincter. The energy delivery device is coupled to the expandable member and has a configuration that controllably produces lesions of a sufficient size, number and configuration in a sphincter so as to create a selectable tightening of the sphincter.

BRIEF DESCRIPTION OF THE DRAWINGS

FIG. 1 is an illustrated lateral view of the upper GI tract including the esophagus and lower esophageal sphincter and the positioning of the GERD treatment apparatus of the present invention the lower esophageal sphincter.

FIG. 2 is a lateral view of the present illustrating apertures in the expandable member.

FIG. 3 illustrates a lateral view of an embodiment of the invention that includes two expandable members and an electrode coupled to a power source.

FIG. 4 illustrates a lateral view of a proximal fitting and distal segments of an embodiment of the invention.

FIG. 5 illustrates a lateral view of the deflection mechanism of the invention.

FIG. 6A illustrates a lateral view of apertures in the expandable member and conforming member of the invention.

FIG. 6B illustrates a lateral view of a microporous membrane used in the fabrication of the expandable member and conforming members of the invention.

FIG. 7 is a lateral view illustrating the use of the deflection mechanism to deflect the expandable member of the present invention.

FIG. 8 is a lateral view illustrating the use of electrolytic solution to create an enhanced RF electrode.

FIG. 9A is a lateral view illustrating a radial distribution of electrodes on the expandable member of the invention.

FIG. 9B is a lateral view illustrating a longitudinal distribution of electrodes on the expandable member of the invention.

FIG. 9C is a lateral view illustrating a spiral distribution of electrodes on the expandable member of the invention.

FIG. 10 is a lateral view illustrating the placement of electrodes on the distal segment of an embodiment the invention.

FIG. 11 is a lateral view illustrating the placement of needle electrodes on the expandable member of an embodiment the invention.

FIG. 12 is a lateral view illustrating the deployment of needle electrodes into the smooth muscle of the LES.

5 FIG. 13 is a lateral view illustrating the position of needle electrodes in the distal segment of the expandable member.

FIG. 14 is a flow chart illustrating the GERD treatment method of the current invention.

10 FIG. 15 A-C are lateral views which illustrate a technique for proper positioning of the GERD treatment apparatus in the LES.

FIG. 16 is a lateral view of sphincter smooth muscle tissue illustrating electromagnetic foci and pathways for the origination and conduction of aberrant electrical signals in the smooth muscle of the lower esophageal sphincter.

15 FIG. 17 is a lateral view illustrating a zone of electrodes of the current invention that comprises a flexible circuit that facilitates contact with the lower esophageal sphincter.

FIG. 18 is a lateral view of the esophageal wall illustrating the infiltration of tissue healing cells into a lesion in the smooth tissue of a esophageal sphincter following treatment with the GERD treatment apparatus of the present invention.

20 FIG. 19 is a view similar to that of FIG. 18 illustrating shrinkage of the lesion site caused by cell infiltration.

FIG. 20 is a lateral view of the esophageal wall illustrating the preferred placement of lesions in the smooth muscle layer of a esophageal sphincter.

25 FIG. 21 is a lateral view illustrating the creation of zones of decreased porosity by sealed conforming members of an embodiment of the present invention.

FIG. 22 is a lateral view illustrating the ultrasound transducer, ultrasound lens and ultrasound power source of an embodiment of the present invention.

FIG. 23 is a lateral view of the esophageal wall illustrating various patterns of lesions created by the apparatus of the present invention.

FIG. 24 is a lateral view of the esophageal wall illustrating the delivery of cooling fluid to the electrode-tissue interface and the creation of cooling zones.

FIG. 25 depicts the flow path, fluid connections and control unit employed to deliver fluid to the electrode-tissue interface and electrodes.

5 FIG. 26 is a lateral view illustrating the placement of cooling apertures adjacent to electrodes in the expandable member.

FIG. 27 depicts the flow path, fluid connections and control unit employed to deliver fluid to the RF electrodes.

10 FIG. 28 is an enlarged lateral view illustrating the placement of sensors on the expandable member.

FIG. 29 depicts a block diagram of the feed back control system that can be used with the GERD treatment apparatus as shown in FIG. 3.

FIG. 30 depicts a block diagram of an analog amplifier, analog multiplexer and microprocessor used with the feedback control system of FIG. 29.

15 FIG. 31 depicts a block diagram of the operations performed in the feedback control system depicted in FIG. 29.

DETAILED DESCRIPTION

Referring now to FIGS. 1 and 2, one embodiment of GERD treatment apparatus 10 that is used to deliver energy to a treatment site 12 to produce lesions 14 in the LES includes a first expandable member 16 with an interior surface 18 and an exterior surface 20. First expandable member 16, which can also be an energy delivery device support member, is configured to receive an expansion medium 22 that inflates first expandable member 16 from a compacted, non-deployed state to a deployed state. Exterior surface 20 includes a plurality of apertures 24. Upon the application of sufficient pressure, first expandable member 16 weeps expansion medium 22 from interior surface 18.

25 While expandable member 16, with a single interior surface 18, is preferred, it will be appreciated that expandable member 16 can be made of

different compositions or materials, with one or more open or closed cells or chambers. The plurality of such cells or chambers can be compressed or configured in a small diameter for insertion, and are then expanded after insertion to establish the desired electrical contact with the targeted surface of the esophagus.

5 Expansion medium 22 may be a gas, fluid or the like. In various embodiments, the expansion medium 22 can be an electrolytic solution. In other embodiments, expansion medium 22 can also be a contrast solution to facilitate imaging of the procedure by fluoroscopy or ultrasonography. Yet in other
10 embodiments, GERD treatment apparatus 10 can include visualization capability including, but not limited to a viewing scope, ultrasound, an expanded eyepiece, fiber optics (including illumination and imaging fibers), video imaging, a light source and the like.

Referring to FIG. 3, a second expandable member 26 can be positioned at least partially adjacent to first expandable member 16. Second expandable member
15 26 receives at least a portion of the expansion medium 22 from interior surface 18.

An electromagnetic energy delivery device 28 is coupled to one of the first or second expandable members 16 and 26, respectively, and configured to be coupled to a power source 30.

20 First and second expandable members 16 and 26 are sized to be expanded to sufficiently dilate the esophagus such that all or a portion of the interior of the lower esophageal sphincter can be accessible to the energy delivery device 28. Expandable members 16 or 26 can dilate the esophageal sphincter in a range of 5-40 mms. It will be appreciated that other devices capable of being in confined non-deployed states, during their introduction into the esophagus and thereafter
25 expanded to deployed states at or near the LES, can be utilized. Such devices include, but are not limited to, basket-shaped devices made of superelastic metals such as nitinol.

Referring to FIG. 4, an extension member 32 with a distal segment 34 is configured to be coupled to first and/or second expandable members 16 and 26. In

one embodiment, extension member 32 is rod-like and can be malleable, flexible, articulated and steerable. In various embodiments, extension member 32 can contain optics, fluid and gas paths, sensor and electronic cabling. In one embodiment, extension member 32 can be a coil-reinforced multilumen catheter, as is well known to those skilled in the art. Extension member 32 has sufficient length to position the first and second expandable members in the LES and/or stomach using a trans-oral approach. Typical lengths include, but are not limited to, a range of 40-180 cms. A proximal fitting 36 of extension member 32 is maneuverable by a medical practitioner. In one embodiment, extension member 32 runs through the center of expandable member 16 and/or 26 and distal segment 34 that extends distally beyond the most distal expandable member. Extension member 32 may be attached to a movable proximal fitting 36 used to control deflection of expandable members 16 or 26, as is more fully explained herein.

Referring to FIG. 5, expandable members 16 and 26 may be initially rolled or folded around extension member 32. Expandable members 16 and 26 can be attached to a deflection mechanism 38, which imparts movement of first and second expandable members 16 and 26 when positioned at the LES. In one embodiment, the deflection mechanism can be a pull wire attached to extension member 32 or first expandable member 16 and to a movable proximal fitting 36, as is well known to those skilled in the art.

Formed spring wires can be included in first expandable member 16 to assist in opening it to the deployed position. Optionally positioned proximal fitting 36 contains a variety of actuators which provide a physician control of GERD treatment apparatus 10, as more fully described hereafter. The actuators can be rocker switches, slider switches and the like, as are well known to those skilled in the art. At least portions of GERD treatment apparatus 10 may be sufficiently radiopaque in order to be visible under fluoroscopy and/or sufficiently echogenic to be visible under ultrasonography.

One embodiment of GERD treatment apparatus 10 is illustrated in FIG. 6A. First expandable member 16 is made of a material that can be an insulator. For

purposes of this disclosure, an insulator is a barrier to thermal or electrical energy flow. In this embodiment, expandable member 16 is substantially surrounded by a conforming member 40 which is also called a fluid conduit. Conforming member 40 receives electrolytic solution from first expandable member 16, heated or not heated, through a plurality of apertures 24 formed in first expandable member 16, and passes it to conforming member 40. In another embodiment, shown in FIG. 6B, first expandable member 16 is made of a microporous material 42 that does not include distinct apertures.

Referring to FIGs. 6A and 6B, conforming member 40 is made of a material that permits controlled delivery of the electrolytic solution to the treatment site 12 through one or more apertures 24. In another embodiment, conforming member 40 can be made of microporous material 42 that does not include distinct apertures. Extension member 32 with first and second expandable members, or alternatively with a single expandable member, is introduced into the esophagus directly, shown in FIG. 1, or through the use of another introducer such as an endoscope (not shown), as is more fully described hereafter with first and second expandable members 16 and 26 in non-deployed configurations.

Referring to FIG. 7, first expandable member 16 can be deflected from side to side to facilitate maneuvering through the esophagus and positioning in the LES. This movement can be imparted by deflection mechanism 38.

A variety of energy sources can be coupled to the porous membrane including, (i) an RF source coupled to an RF electrode, (ii) a coherent source of light coupled to an optical fiber, (iii) an incoherent light source coupled to an optical fiber, (iv) a heated fluid coupled to a catheter with an open channel configured to receive the heated fluid, (v) a heated fluid coupled to a catheter with an open channel configured to receive the heated fluid, (vi) a cooled fluid coupled to a catheter with a closed channel configured to receive the cooled fluid, (vii) a cooled fluid coupled to a catheter with an open channel configured to receive the cooled fluid, (viii) a cryogenic fluid, (ix) a resistive heating source, (x) a microwave source providing energy from 915 MHz to 2.45 GHz and coupled to a microwave

antenna, (xi) an ultrasound power source coupled to an ultrasound emitter, wherein the ultrasound power source produces energy in the range of 300 KHZ to 3 GHz or (xii) a microwave source. For ease of discussion for the remainder of this application, the energy source utilized is an RF source and electromagnetic energy delivery device 28 is a single or a plurality of RF electrodes 44, also described as electrodes 44. However, all of the other mentioned energy sources are equally applicable to GERD treatment apparatus 10.

For the case of RF energy, RF electrode 44 may operated in either bipolar or monopolar mode with a ground pad electrode. In a monopolar mode of delivering RF energy, a single electrode 44 is used in combination with an indifferent electrode patch that is applied to the body to form the other contact and complete an electrical circuit. Bipolar operation is possible when two or more electrodes 44 are used. Multiple electrodes 44 may be used. Also, electrolytic solution serves as an enhanced RF electrode 44' when coupled with an RF electrode 44 (refer to FIG. 8).

Also when the energy source is RF, power source 30, which will now be referred to as a RF energy source 30, may have multiple channels, delivering separately modulated power to each electrode 44. This reduces preferential heating that occurs when more energy is delivered to a zone of greater conductivity and less heating occurs around electrodes 44 which are placed into less conductive tissue. If the tissue hydration or the blood infusion in the tissue is uniform, a single channel RF energy source 30 may be used to provide power for generation of lesions 14 relatively uniform in size.

Electric current flowing through targeted smooth muscle tissue causes heating due to resistance of the tissue resulting in injury to the tissue which can be sufficient to cause the death of affected cells, also known as necrosis. For ease of discussion for the remainder of this application, cell injury will include all cellular effects resulting from the delivery of energy from the electrode 44 up to and including cell necrosis. Cell injury can be accomplished as a relatively simple

medical procedure with local anesthesia. In one embodiment, cell injury proceeds to a depth of approximately 1-4 mms from the surface of the mucosal layer.

Referring now to FIGs 9A-C, electrodes 44 can cover all or a portion of expandable members 16 or 26 and/or conforming member 40. Also, electrodes 44 may be distributed in a variety of patterns along an exterior or interior surface of either expandable member 16 or 26 or conforming member 40, in order to produce a desired placement and pattern of lesions 14. Typical electrode distribution patterns include, but are not limited, to a radial distribution 46 (refer to FIG. 9A) or a longitudinal distribution 48 (refer to FIG. 9B). It will be appreciated that other patterns and geometries for electrode placement, such as a spiral distribution 50 (refer to FIG. 9C) may also be suitable. In one embodiment, electrode 44 is positioned on distal segment 34 of extension member 32 (refer to FIG. 10). These electrodes may be cooled as described hereafter. Additionally, distal segment 34 may include apertures 24 for delivery of cooling and electrolytic solution as described hereafter.

Electrodes 44 can have a variety of shapes and sizes. Possible shapes include but are not limited to circular, rectangular, conical and pyramoidal. Electrode surfaces can be smooth or textured and concave or convex. Surface areas can range from 0.1 mm² to 200 mm². It will be appreciated that other geometries and surface areas may be equally suitable. In one embodiment, electrodes 44 can be in the shape of needles and of sufficient sharpness and length to penetrate into the smooth muscle of the esophageal wall. In this case, needle electrodes 52 are attached to expandable member 16 or 26 which is located inside conforming member 40 (refer to FIG. 11). During introduction of the GERD treatment apparatus 10 into the esophagus, needle electrodes 52 remain retracted inside conforming member 40. Once GERD treatment apparatus 10 is properly positioned at the treatment site 12, needle electrodes 52 are deployed by expansion of expandable member 16 or 26, resulting in protrusion of needle electrodes 52 through needle apertures 54 in conforming member 40 and into the smooth muscle tissue of the treatment site 12 (refer to FIG. 12). In another embodiment, distal

segment 34 may also contain needle apertures 54 for protrusion of needle electrodes 52 into the smooth muscle of the esophageal wall. In this embodiment, shown in FIG. 13 needle electrodes 52 are coupled to an insulated guide wire 56 (known to those skilled in the art) which is advanced through a guide wire lumen 58 in extension member 32.

5

FIG. 14 is a flow chart illustrating one embodiment of the operation of GERD treatment apparatus 10. In this embodiment, GERD treatment apparatus 10 is first introduced into the esophagus under local anesthesia. GERD treatment apparatus 10 can be introduced into the esophagus by itself or through a lumen in an endoscope, such as disclosed in U.S. Patents Nos. 5,448,990 and 5,275,608, incorporated herein by reference, or similar esophageal access device known to those skilled in the art. Expandable member 16 or 26 is expanded with the introduction of a fluid or gaseous expansion medium 22, such as an electrolytic solution, or a combination of both. This serves to temporarily dilate the esophagus sufficiently to efface a portion of or all of the folds of the LES. In an alternative embodiment, esophageal dilation and subsequent LES fold effacement can be accomplished by insufflation of the esophagus (a known technique) using gas introduced into the esophagus through a channel in the GERD treatment device, or an endoscope or similar esophageal access device as described above. Once treatment is completed, expandable members 16 or 26 are evacuated of fluid or gas and returned to their predeployed state and GERD treatment apparatus 10 is withdrawn from the esophagus. This results in the LES returning to approximately its pretreatment state and diameter.

10

15

20

25

In one embodiment, electrolytic solution is introduced into expandable member 16 or 26, causing it to become distended and be self-retained in the esophagus. Expandable member 16 or 26 can also be expanded mechanically through the use of formed spring wires (not shown) used alone or in combination with a fluid.

30

Electrolytic solution in expandable member 16 may be heated to a temperature, which can be modified and adjusted as necessary. For example,

electrolytic solution can be heated and maintained at a temperature between about 65-90°C. It can be initially introduced into first expandable member 16 at the higher temperature, or it can be heated to the higher temperature in first expandable member 16. By providing a heated electrolytic solution, there is a reduction in the amount of time needed to complete a satisfactory degree of tissue injury of targeted cells.

It is important to have proper positioning of the expandable members 16 and 26 and conforming member 40 in the sphincter during both diagnosis and treatment phases. This can be facilitated by the following procedure: (I) carefully advancing one or both of expandable members 16 and 26 in an unexpanded state, distal to the lower esophageal sphincter, (ii) expanding the distal one of the two expandable members and (iii) carefully withdrawing GERD treatment apparatus 10 proximally until resistance is encountered. This procedure is illustrated in FIGs. 15 A-C.

The diagnostic phase then begins. This is achieved through a variety of diagnostic methods, including, but not limited to, the following: (I) visualization of the interior surface of the esophagus via an endoscope or other viewing apparatus inserted into the esophagus, (ii) visualization of the interior morphology of the esophageal wall using ultrasonography to establish a baseline for the tissue to be treated, (iii) impedance measurement to determine the electrical conductivity between the esophageal mucosal layers and GERD treatment apparatus 10 and (iv) measurement and surface mapping of the electropotential of the LES during varying time periods which may include such events as depolarization, contraction and repolarization of LES smooth muscle tissue. This latter technique is done to determine specific sites in the LES to be treated which are acting as foci 60 or pathways 62 for abnormal or inappropriate polarization and relaxation of the smooth muscle of the LES (Refer to FIG. 16).

In the treatment phase, the delivery of energy of the targeted site can be conducted under feedback control, manually or a combination of both. Feedback control enables GERD treatment apparatus 10 to be positioned and retained in the

esophagus during treatment with minimal attention by the physician. When positioned at the LES, GERD treatment apparatus 10 provides a relatively even flow of heated electrolytic solution to facilitate the cell injury process. As shown in FIG. 17, GERD treatment apparatus 10 also may have a plurality of electrodes 44 contained in zones that effectively create a flexible circuit 64 which in turn, facilitates contact of the electrode 44 with all or a portion of the interior surface areas of the LES. Electrodes 44 can be multiplexed in order to treat the targeted site or only a portion thereof. Feedback can be included and is achieved by, (I) visualization, (ii) impedance measurement, (iii) ultrasonography, (iv) temperature measurement; and, (v) sphincter contractile force measurement via manometry. The feedback mechanism permits the selected on-off switching of different electrodes 44 of the flexible circuit 64 in a desired pattern, which can be sequential from one electrode 44 to an adjacent electrode 44, or can jump around between non-adjacent electrodes 44. Individual electrodes 44 are multiplexed and volumetrically controlled by a controller.

The area and magnitude of cell injury in the LES can vary. However, it is desirable to deliver sufficient energy to the targeted treatment site 12 to be able to achieve tissue temperatures in the range of 55-95° C and produce lesions 14 at depths ranging from 1-4 mm from the interior surface of the LES. Typical energies delivered to the esophageal wall include, but are not limited to, a range between 100 and 50,000 joules per electrode 44. It is also desirable to deliver sufficient energy such that the resulting lesions 14 have a sufficient magnitude and area of cell injury to cause an infiltration of lesion 14 by fibroblasts 66, myofibroblasts 68, macrophages 70 and other cells involved in the tissue healing process (refer to FIG. 18). As shown in FIGs. 19A and B, these cells cause a contraction of tissue around lesion 14, decreasing its volume and, or altering the biomechanical properties at lesion 14 so as to result in a tightening of LES. These changes are reflected in transformed lesion 14' shown in 19 B. The diameter of lesions 14 can vary between 0.1 to 4 mm. It is preferable that lesions 14 are less than 4 mm in diameter in order to reduce the risk of thermal damage to the mucosal layer. In one

embodiment, a 2 mm diameter lesion 14 centered in the wall of the smooth muscle provides a 1 mm buffer zone to prevent damage to the mucosa, submucosa and adventia, while still allowing for cell infiltration and subsequent tightening on approximately 50% of the thickness of the wall of the smooth muscle (refer to FIG. 20).

In one embodiment, GERD treatment apparatus 10 conforms tightly with the interior of the esophagus so that all, or nearly all, of the interior circumference of a desired segment of the LES is in contact with a surface of conforming member 40. Conforming member 40 is fitted into the entire LES and expandable member 16 does not have to be moved about the esophagus to complete the treatment. Alternatively, GERD treatment apparatus 10 may not entirely fill the esophagus, and GERD treatment apparatus 10 is then moved about the esophagus in order to treat all of the esophagus, or those sections where tightening of the lower esophageal sphincter is desired.

Conforming member 40 is made of a material that substantially conforms to the surface of the LES and, or other sphincters. This provides better conformity than the mere use of expandable member 16. As a result, the delivery of treatment energy to the LES is enhanced. Energy delivery may also be enhanced by use of a conducting surface 72 which may cover all, or part of, the exterior of conforming member 40. The surface of conforming member 40 can be made conductive by a variety of means including, but not limited to chemical coating with a conductive material, implantation with conductive ions and application of a conductive film.

Conforming member 40 can have a thickness in the range of about 0.01 to 2.0 cm. Conforming member 40 can be made of a foam type material. Suitable materials include, but are not limited to, knitted polyester, continuous filament polyester, polyester-cellulose, rayon, polyamide, polyurethane, polyethylene, silicone, and the like. Suitable commercial foams include, (i) Opcell, available from Sentinel Products Corp., Hyannis, Massachusetts and (ii) UltraSorb, HT 4201 or HT 4644MD from Wilshire Contamination Control, Carlsbad, California.

Conforming member 40 has characteristics that make it particularly moldable and

formable to irregular surfaces. In one embodiment, conforming member 40 is made of an open cell foam, or alternatively it can be a thermoplastic film such as polyurethane, low density polyethylene, or it may be a silicone. Additionally, conforming member 40 can be capable of extruding conductive materials from
5 conforming member 40 itself.

FIG. 21 illustrates that conforming member 40 can be created by sealing two smaller conforming members 74 and 76 together. Smaller conforming members 74 and 76 are sealed together between individual electrodes 44. This creates a pocket or zone 78. Zone 78 has a lower porosity for the flow of
10 electrolytic solution than non-zone sections 80, e.g., all other sections of conforming member 40 which do not include a zone 78 with an associated electrode 44. The porosity of non-zone sections 80 is greater than the porosity of zones 78.

From a diagnostic standpoint, it is desirable to image the interior surface
15 18 and wall of the LES including the size and position of created lesions 14. It is desirable to create a map of these structures which can input to a controller and used to direct the delivery of energy to the treatment site. Referring to FIG. 22, this can be accomplished through the use of ultrasonography (a known procedure) which involves the use of an ultrasound power source 82 coupled to one or more
20 ultrasound transducers 84 that are positioned in or on expandable member 16 or 26 or conforming member 40. An output is associated with ultrasound power source 82 and RF energy source 30.

Each ultrasound transducer 84 can include a piezoelectric crystal 86 mounted on a backing material 88 that is in turn attached to expandable members
25 16 or 26 or conforming member 40. An ultrasound lens 90, fabricated on an electrically insulating material 92, is mounted over the piezoelectric crystal 86. The piezoelectric crystal 86 is connected by electrical leads 94 to ultrasound power source 82. Each ultrasound transducer 84 transmits ultrasound energy through conforming member 40 or expandable members 16 or 26 into adjacent tissue.
30 Ultrasound transducers 84 can be in the form of an imaging probe such as Model

21362, manufactured and sold by Hewlett Packard Company, Palo Alto, California. In one embodiment, two ultrasound transducers 84 are positioned on opposite sides of expandable member 16 to create an image depicting the size and position of lesion 14 in the LES.

5 It is desirable that lesions 14 are predominantly located in the smooth muscle layer of esophageal wall at the depths ranging from 1 to 4 mms from the interior surface of the sphincter. However, lesions 14 can vary both in number and position within the sphincter wall. It may be desirable to produce a pattern of multiple lesions 14 within the esophageal smooth muscle in order to obtain a
10 selected degree of tightening of the LES. Typical lesion patterns shown in FIGs. 23 A-C include but are not limited to, (i) a concentric circle of lesions 14 all at fixed depth in the smooth muscle layer evenly spaced along the radial axis of the LES, (ii) a wavy or folded circle of lesions 14 at varying depths in the smooth muscle layer evenly spaced along the radial axis of the LES, (iii) lesions 14 randomly
15 distributed at varying depths in the smooth muscle, but evenly spaced in a radial direction; and, (iv) an eccentric pattern of lesions 14 in one or more radial locations in the smooth muscle wall. Accordingly, the depth of RF and thermal energy penetration in the lower esophageal sphincter is controlled and selectable. The selective application of energy to the lower esophageal sphincter may be the even
20 penetration of RF energy to the entire targeted site, a portion of it, or applying different amounts of RF energy to different sites depending on the condition of the sphincter. If desired, the area of cell injury can be substantially the same for every treatment event.

25 Referring to FIG. 24, it may be desirable to cool all or a portion of the area near the electrode-tissue interface 96 before during and after the delivery of energy in order to reduce the degree and area of cell injury. Specifically the use of cooling preserves the mucosal layers and protects or otherwise reduces the degree of cell damage to cooled zone 98 in the vicinity of the lesion 14. This can be accomplished through the use of a cooling fluid 100 that weeps out of the

expandable members 16 and 26 or conforming member 40 which is in fluid communication with a continuous lumen 102 in extension member 32 that is, in turn, in fluid communication with fluid reservoir 104 and a control unit 106, whose operation will be described hereafter that controls the delivery of the fluid (Refer to FIG. 25). All or only a portion of electrode 44 may also be cooled.

Similarly, it may also be desirable to cool all or a portion of the electrode 44. The rapid delivery of heat through electrode 44, may result in the build up of charred biological matter on electrode 44 (from contact with tissue and fluids e.g. blood) that impedes the flow of both thermal and electrical energy from electrode 44 to adjacent tissue and causes an electrical impedance rise beyond a cutoff value set on RF energy source 30. A similar situation may result from the desiccation of tissue adjacent to electrode 44. Cooling of the electrode 44 can be accomplished by cooling fluid 100 that weeps out of expandable members 16 and/or 26 and conforming member 40 as described previously. In another embodiment, expandable member 16 may contain a plurality of cooling apertures 108 adjacent or directed toward electrode 44 to enhance the flow of cooling solution and, or cooling rate of electrode 44 and adjacent tissue (refer to FIG. 26). Referring now to FIG. 27, electrode 44 may also be cooled via a fluid channel 110 in electrode 44 that is in fluid communication with fluid reservoir 104 and control unit 106 via the continuous lumen 102 in extension member 32 as described previously.

As shown in FIG. 28. one or more sensors 112 may be positioned adjacent or on electrode 44 for sensing the temperature of esophageal tissue at treatment site 12. More specifically, sensors 112 permit accurate determination of the surface temperature of the esophagus at electrode-tissue interface 96. This information can be used to regulate both the delivery of energy and cooling solution to the interior surface of the esophagus. In various embodiments sensors 112 can be positioned at any position on expandable members 16 and 26 and conforming member 40. Suitable sensors that may be used for sensor 112 include: thermocouples, fiber optics, resistive wires, thermocouple IR detectors, and the like. Suitable

thermocouples for sensor 112 include: T type with copper constantene, J type, E type and K types as are well known those skilled in the art.

5 Temperature data from sensors 112 are fed back to control unit 106 and through an algorithm which is stored within a microprocessor memory of control unit 106. Instructions are sent to an electronically controlled micropump (not shown) to deliver fluid through the fluid lines at the appropriate flow rate and duration to provide control temperature at the electrode-tissue interface 96 (refer to FIG. 28).

10 The reservoir of control unit 106 may have the ability to control the temperature of the cooling fluid 100 by either cooling the fluid or heating the fluid. Alternatively, a fluid reservoir 104 of sufficient size may be used in which the cooling fluid 100 is introduced at a temperature at or near that of the normal body temperature. Using a thermally insulated reservoir 114, adequate control of the tissue temperature may be accomplished without need of refrigeration or heating of the cooling fluid 100. Cooling fluid 100 flow is controlled by control unit 106 or another feedback control system (described herein) to provide temperature control at the electrode-tissue interface 96.

15 A second diagnostic phase may be included after the treatment is completed. This provides an indication of lower esophageal tightening treatment success, and whether or not a second phase of treatment, to all or only a portion of the esophagus, now or at some later time, should be conducted. The second diagnostic phase is accomplished through, (i) visualization, (ii) measuring impedance, (iii) ultrasonography or (iv) temperature measurement, (v) measurement of LES tension and contractile force via manometry.

25 In one embodiment, GERD treatment apparatus 10 is coupled to an open or closed loop feedback system. Referring now to FIG. 29, an open or closed loop feedback system couples sensor 346 to energy source 392. In this embodiment, RF electrode 314 is one or more RF electrodes 314.

The temperature of the tissue, or of RF electrode 314 is monitored, and the output power of energy source 392 adjusted accordingly. The physician can, if desired, override the closed or open loop system. A microprocessor can be included and incorporated in the closed or open loop system to switch power on and off, as well as modulate the power. The closed loop system utilizes a microprocessor 394 to serve as a controller, monitor the temperature, adjust the RF power, analyze at the result, refeed the result, and then modulate the power.

With the use of sensor 346 and the feedback control system a tissue adjacent to RF electrode 314 can be maintained at a desired temperature for a selected period of time without impeding out. Each RF electrode 314 is connected to resources which generate an independent output. The output maintains a selected energy at RF electrode 314 for a selected length of time.

Current delivered through RF electrode 314 is measured by current sensor 396. Voltage is measured by voltage sensor 398. Impedance and power are then calculated at power and impedance calculation device 400. These values can then be displayed at user interface and display 402. Signals representative of power and impedance values are received by a controller 404.

A control signal is generated by controller 404 that is proportional to the difference between an actual measured value, and a desired value. The control signal is used by power circuits 406 to adjust the power output in an appropriate amount in order to maintain the desired power delivered at respective RF electrodes 314.

In a similar manner, temperatures detected at sensor 346 provide feedback for maintaining a selected power. Temperature at sensor 346 is used as a safety means to interrupt the delivery of energy when maximum pre-set temperatures are exceeded. The actual temperatures are measured at temperature measurement device 408, and the temperatures are displayed at user interface and display 402. A control signal is generated by controller 404 that is proportional to the difference between an actual measured temperature and a desired temperature.

The control signal is used by power circuits 406 to adjust the power output in an appropriate amount in order to maintain the desired temperature delivered at the sensor 346. A multiplexer can be included to measure current, voltage and temperature, at the sensor 346, and energy can be delivered to RF electrode 314 in monopolar or bipolar fashion.

Controller 404 can be a digital or analog controller, or a computer with software. When controller 404 is a computer it can include a CPU coupled through a system bus. On this system can be a keyboard, a disk drive, or other non-volatile memory systems, a display, and other peripherals, as are known in the art. Also coupled to the bus is a program memory and a data memory.

User interface and display 402 includes operator controls and a display. Controller 404 can be coupled to imaging systems, including but not limited to ultrasound, CT scanners, X-ray, MRI, mammographic X-ray and the like. Further, direct visualization and tactile imaging can be utilized.

The output of current sensor 396 and voltage sensor 398 is used by controller 404 to maintain a selected power level at RF electrode 314. The amount of RF energy delivered controls the amount of power. A profile of power delivered can be incorporated in controller 404 and a preset amount of energy to be delivered may also be profiled.

Circuitry, software and feedback to controller 404 result in process control, and the maintenance of the selected power setting that is independent of changes in voltage or current, and used to change, (i) the selected power setting, (ii) the duty cycle (on-off time), (iii) bipolar or monopolar energy delivery and (iv) fluid delivery, including flow rate and pressure. These process variables are controlled and varied, while maintaining the desired delivery of power independent of changes in voltage or current, based on temperatures monitored at sensor 346.

As illustrated in FIG. 30, current sensor 396 and voltage sensor 398 are connected to the input of an analog amplifier 410. Analog amplifier 410 can be a

conventional differential amplifier circuit for use with sensor 346. The output of analog amplifier 410 is sequentially connected by an analog multiplexer 412 to the input of A/D converter 414. The output of analog amplifier 410 is a voltage which represents the respective sensed temperatures. Digitized amplifier output voltages are supplied by A/D converter 414 to microprocessor 394. Microprocessor 394 may be a type 68HCII available from Motorola. However, it will be appreciated that any suitable microprocessor or general purpose digital or analog computer can be used to calculate impedance or temperature.

Microprocessor 394 sequentially receives and stores digital representations of impedance and temperature. Each digital value received by microprocessor 394 corresponds to different temperatures and impedances.

Calculated power and impedance values can be indicated on user interface and display 402. Alternatively, or in addition to the numerical indication of power or impedance, calculated impedance and power values can be compared by microprocessor 394 with power and impedance limits. When the values exceed predetermined power or impedance values, a warning can be given on user interface and display 402, and additionally, the delivery of RF energy can be reduced, modified or interrupted. A control signal from microprocessor 394 can modify the power level supplied by energy source 392.

FIG. 31 illustrates a block diagram of a temperature/impedance feedback system that can be used to control the flow rate and duration of cooling fluid 100 through continuous lumen 102 to expandable and conforming members 16, 26 and 40 and or RF electrode 314. Energy is delivered to RF electrode 314 by energy source 392, and applied to tissue site 424. A monitor 416 ascertains tissue impedance, based on the energy delivered to tissue, and compares the measured impedance value to a set value. If the measured impedance exceeds the set value, a disabling signal 418 is transmitted to energy source 392, ceasing further delivery of energy to RF electrode 314. If measured impedance is within acceptable limits, energy continues to be applied to the tissue. During the application of energy

sensor 346 measures the temperature of tissue and/or RF electrode 314. A
comparator 420 receives a signal representative of the measured temperature and
compares this value to a pre-set signal representative of the desired temperature.
Comparator 420 sends a signal to a flow regulator 422 connected to an
5 electronically controlled micropump (not shown) representing a need for an
increased cooling fluid 100 flow rate, if the tissue temperature is too high, or to
maintain the flow rate if the temperature has not exceeded the desired temperature.

The foregoing description of a preferred embodiment of the invention has
been presented for purposes of illustration and description. It is not intended to be
10 exhaustive or to limit the invention to the precise forms disclosed. Obviously, many
modifications and variations will be apparent to practitioners skilled in this art. It is
intended that the scope of the invention be defined by the following claims and their
equivalents.

What is claimed is:

CLAIMS

- 1 1. An apparatus, comprising:
2 an expandable member being sized to be positionable in a sphincter; and
3 an energy delivery device coupled to the expandable member, the energy
4 delivery device having a configuration that controllably produces lesions of a
5 sufficient size, number and configuration in an interior of the sphincter so as to
6 create a selectable tightening of the sphincter.
- 1 2. The apparatus of claim 1, wherein the configuration of the energy
2 delivery device includes a plurality of energy delivery members distributed on a
3 surface of the expandable member.
- 1 3. The apparatus of claim 2, wherein the plurality of energy delivery
2 members are radially distributed along a surface of the energy delivery device
3 expandable member.
- 1 4. The apparatus of claim 2, wherein the plurality of energy delivery
2 members are longitudinally distributed along a surface of the expandable member.
- 1 5. The apparatus of claim 1, wherein the energy delivery device
2 covers a portion of the surface of the expandable member.
- 1 6. The apparatus of claim 2, wherein the energy delivery device
2 covers substantially all of an exterior surface of the expandable member
- 1 7. The apparatus of claim 1, wherein the expandable member is sized
2 to be positionable in a sphincter and to allow the energy delivery device to contact a
3 portion of the inner surface of a sphincter.

1 8. The apparatus of claim 1, wherein the expandable member is sized
2 to be positionable in a sphincter and to allow the energy delivery device to contact
3 all of an inner surface of the sphincter.

1 9. The apparatus of claim 1, where the energy delivery device is sized
2 to be positionable in the sphincter and non-permanently dilate the sphincter from a
3 contracted state; and

4 wherein the sphincter returns to a pretreatment contracted state upon a
5 removal of the expandable member from the sphincter.

1 10. The apparatus of claim 1, wherein the lesions are formed in a
2 muscle tissue underlying a sphincter mucosal layer.

1 11. The apparatus of claim 1, wherein the sphincter is a lower
2 esophageal sphincter.

1 12. The apparatus of claim 1, wherein the configuration of the energy
2 delivery device creates the lesions at a fixed depth from a mucosal surface layer of
3 the sphincter of no more than 4 mms.

1 13. The apparatus of claim 1, wherein the configuration of the energy
2 delivery device creates the lesions and minimizes injury to a mucosal and a
3 submucosal layer of the sphincter.

1 14. The apparatus of claim 1, wherein the configuration of the energy
2 delivery device creates the lesions and reduces a frequency of sphincter relaxation.

1 15. The apparatus of claim 1, wherein the configuration of the energy
2 delivery device creates the lesions and reduces a duration of sphincter relaxation.

WO 99/35986

PCT/US99/00693

1 16. The apparatus of claim 1, wherein the configuration of the energy
2 delivery device creates the lesions and reduces a frequency of reflux of stomach
3 contents into an esophagus.

1 17. The apparatus of claim 1, wherein the configuration of the energy
2 delivery device creates the lesions and reduces a frequency of a symptom of reflux
3 of stomach contents into an esophagus.

1 18. The apparatus of claim 1, wherein the configuration of the energy
2 delivery device creates the lesions and reduces an incidence of a sequela of reflux of
3 stomach contents into an esophagus.

1 19. The apparatus of claim 1, wherein the energy delivery device is
2 positioned on an exterior surface of the expandable member.

1 20. The apparatus of claim 1, wherein the energy delivery device is
2 positioned on an interior surface of the expandable member.

1 21. The apparatus of claim 1, further comprising:
2 a lumen positioned in an interior of the expandable member.

1 22. The apparatus of claim 1, wherein the expandable member is
2 expandable.

1 23. The apparatus of claim 1, wherein the expandable member is a
2 balloon.

1 24. The apparatus of claim 1, wherein the expandable member is made
2 of an expandable material.

1 25. The apparatus of claim 1, wherein the expandable member is made
2 of a porous material.

1 26. The apparatus of claim 1, further comprising:
2 an electrolytic solution housed in an expanded expandable member.

1 27. The apparatus of claim 1, wherein the configuration of the energy
2 delivery device delivers energy to promote a fibroblast cell infiltration at a site of
3 the lesions.

1 28. The apparatus of claim 1, wherein the configuration of the energy
2 delivery device delivers energy to promote a fibroblast growth at a site of the
3 lesions.

1 29. The apparatus of claim 1, wherein the configuration of the energy
2 delivery device delivers energy that promotes a myofibroblast cell infiltration at a
3 site of the lesions.

1 30. The apparatus of claim 1, wherein the configuration of the energy
2 delivery device creates a tightening of a lower esophageal sphincter without
3 permanently damaging anatomical structures near the lower esophageal sphincter.

1 31. The apparatus of claim 1, wherein the configuration of the energy
2 delivery device creates a tightening of the lower esophageal sphincter without
3 permanently damaging an aorta positioned near the lower esophageal sphincter.

WO 99/35986

PCT/US99/00693

1 32. The apparatus of claim 1, wherein the configuration of the energy
2 delivery device creates a tightening of the lower esophageal sphincter without
3 permanently damaging a vagus nerve positioned near the lower esophageal
4 sphincter.

1 33. The apparatus of claim 1, wherein the configuration of the energy
2 delivery device creates a tightening of the lower esophageal sphincter without
3 permanently damaging an esophageal plexus of nerves and veins positioned near
4 the lower esophageal sphincter.

1 34. The apparatus of claim 1, wherein the configuration of the energy
2 delivery device creates a tightening of the lower esophageal sphincter while
3 preserving a blood supply to the lower esophageal sphincter.

1 35. The apparatus of claim 1, wherein the energy delivery device is an
2 RF electrode.

1 36. The apparatus of claim 35, further comprising:
2 an RF energy source coupled to the RF electrode.

1 37. The apparatus of claim 1, wherein the energy delivery device is a
2 microwave antenna.

1 38. The apparatus of claim 37, further comprising:
2 a microwave energy source coupled to the microwave antenna.

1 39. The apparatus of claim 1, wherein the energy delivery device is a
2 waveguide.

- 1 40. The apparatus of claim 39, further comprising:
2 a light source coupled to the waveguide.
- 1 41. The apparatus of claim 40, wherein the light source is a laser.
- 1 42. The apparatus of claim 1, wherein the energy delivery device is an
2 acoustical transducer.
- 1 43. The apparatus of claim 1, wherein the energy delivery device is a
2 resistive heating device.
- 1 44. The apparatus of claim 1, further comprising:
2 a visualization device coupled to the expandable member.
- 1 45. The apparatus of claim 1, further comprising:
2 an extension member coupled to the expandable member.
- 1 46. The apparatus of claim 45, wherein a proximal portion of the
2 extension member is maneuverable by a medical practitioner.
- 1 47. The apparatus of claim 1, wherein the energy delivery device is a
2 plurality of RF electrodes.
- 1 48. The apparatus of claim 47, wherein the plurality of electrodes is a
2 flexible circuit.
- 1 49. The apparatus of claim 1, further comprising:
2 a mechanical expansion device coupled to the expandable member.
- 1 50. An apparatus, comprising:

2 an expandable member means sized to be positionable in a lower
3 esophageal sphincter and non-permanently dilate the lower esophageal sphincter
4 from a contracted state;

5 an energy delivery device means coupled to the expandable member means,
6 the energy delivery device means having a configuration that controllably produces
7 lesions of a sufficient size, number and configuration in an interior of the lower
8 esophageal sphincter to create a tightening of the lower esophageal sphincter; and,

9 wherein the lower esophageal sphincter returns to a contracted state upon a
10 removal of the expandable member means from the sphincter.

1 51. The apparatus of claim 50, wherein the energy delivery device
2 means has a configuration that controllably produces lesions an interior of the lower
3 esophageal sphincter without creating a permanent impairment of the lower
4 esophageal sphincter's ability to achieve a physiologically normal state of closure.

1 52. The apparatus of claim 50, wherein the energy delivery device is
2 positioned on an exterior surface of the expandable member means.

1 53. The apparatus of claim 50, wherein the energy delivery device is
2 positioned on an interior surface of the expandable member means.

1 54. The apparatus of claim 50, further comprising:
2 a lumen means positioned in an interior of the expandable member means.

1 55. The apparatus of claim 50, wherein the expandable member means
2 is expandable.

1 56. The apparatus of claim 50, wherein the expandable member means
2 is a balloon.

1 57. The apparatus of claim 50, wherein the expandable member means
2 is made of an expandable material.

1 58. The apparatus of claim 50, wherein the expandable member means
2 is made of a porous material.

1 59. The apparatus of claim 57, further comprising:
2 an electrolytic solution means housed in an expanded expandable member
3 means.

1 60. The apparatus of claim 50, wherein the configuration of the energy
2 delivery device means delivers energy to the interior of the lower esophageal
3 sphincter and creates a fibroblast proliferation in the interior of the lower
4 esophageal sphincter.

1 61. The apparatus of claim 50, wherein the configuration of the energy
2 delivery device means delivers energy to the interior of the lower esophageal
3 sphincter and creates a myofibroblast proliferation in the lower esophageal
4 sphincter.

1 62. The apparatus of claim 50, wherein the configuration of the energy
2 delivery device means creates a tightening of the lower esophageal sphincter
3 without permanently disrupting an aorta positioned near the lower esophageal
4 sphincter.

1 63. The apparatus of claim 50, wherein the configuration of the energy
2 delivery device means creates a tightening of the lower esophageal sphincter
3 without permanently damaging a vagus nerve positioned near the lower esophageal
4 sphincter.

1 64. The apparatus of claim 50, wherein the configuration of the energy
2 delivery device means creates a tightening of the lower esophageal sphincter
3 without permanently damaging an esophageal plexus of nerves and veins positioned
4 near the lower esophageal sphincter.

1 65. The apparatus of claim 50, wherein the configuration of the energy
2 delivery device means creates a tightening of the lower esophageal sphincter while
3 preserving a blood supply to the lower esophageal sphincter.

1 66. The apparatus of claim 50, wherein the configuration of the energy
2 delivery device means creates a tightening of the lower esophageal sphincter while
3 creating submucosal lesions in the lower esophageal sphincter.

1 67. The apparatus of claim 50, wherein the energy delivery device
2 means is an RF electrode means.

1 68. The apparatus of claim 47, further comprising:
2 an RF energy source means coupled to the RF electrode means.

1 69. The apparatus of claim 50, wherein the energy delivery device
2 means is a microwave antenna means.

1 70. The apparatus of claim 69, further comprising:
2 a microwave energy source means coupled to the microwave antenna
3 means.

1 71. The apparatus of claim 50, wherein the energy delivery device
2 means is a waveguide means.

WO 99/35986

PCT/US99/00693

1 72. The apparatus of claim 71, further comprising:
2 a light source means coupled to the waveguide means.

1 73. The apparatus of claim 72, wherein the light source means is a laser
2 means.

1 74. The apparatus of claim 50, wherein the energy delivery device
2 means is an acoustical transducer means.

1 75. The apparatus of claim 74, further comprising:
2 an acoustical energy source means coupled to the acoustical transducer
3 means.

1 76. The apparatus of claim 50, wherein the energy delivery device
2 means is a resistive heating device means.

1 77. The apparatus of claim 50, further comprising:
2 a visualization device means coupled to the expandable member means.

1 78. The apparatus of claim 50, further comprising:
2 a extension member means coupled to the expandable member means.

1 79. The apparatus of claim 78, wherein a proximal portion of the
2 extension member means is maneuverable by a medical practitioner.

1 80. The apparatus of claim 50, wherein the energy delivery device
2 means is a plurality of RF electrode means.

WO 99/35986

PCT/US99/00693

1 81. The apparatus of claim 80, wherein the plurality of electrode means
2 is a flexible circuit means.

1 82. The apparatus of claim 50, further comprising:
2 a mechanical expansion device means coupled to the expandable member
3 means.

1 83. A method of treating a sphincter, comprising:
2 providing an expandable member sized to be positionable in the sphincter
3 and configured to non-permanently open the sphincter from a contracted
4 configuration, and an energy delivery device coupled to the expandable member;
5 introducing the expandable member in the sphincter;
6 dilating the sphincter from the contracted state;
7 delivering sufficient energy from the energy source to the sphincter to
8 tighten the sphincter; and
9 removing the expandable member from the sphincter.

1 84. The method of claim 83, wherein the energy delivery device has a
2 configuration that controllably produces lesions an interior of the sphincter without
3 creating a permanent impairment of the sphincter's ability to achieve a
4 physiologically normal state of closure.

1 85. The method of claim 83, wherein energy delivery device delivers
2 sufficient energy to cause a proliferation of fibroblast cells in the sphincter.

1 86. The method of claim 85, wherein the energy delivery device
2 delivers sufficient energy to cause a proliferation of myofibroblast cells in the
3 sphincter.

1 87. The method of claim 83, wherein the energy delivery device
2 delivers sufficient energy to create a tightening of the sphincter without permanently
3 damaging anatomical structures near the sphincter.

1 88. The method of claim 87, wherein the energy delivery device
2 delivers sufficient energy to create a tightening of the sphincter without permanently
3 disrupting an aorta positioned near the sphincter.

1 89. The method of claim 87, wherein the energy delivery device
2 delivers a sufficient amount of energy to create a tightening of the lower esophageal
3 sphincter without permanently damaging a vagus nerve positioned near the
4 sphincter.

1 90. The method of claim 87, wherein the energy delivery device
2 delivers a sufficient amount of energy to create a tightening of the lower esophageal
3 sphincter without permanently damaging an esophageal plexus of nerves and veins
4 positioned near the sphincter.

1 91. The method of claim 87, wherein the energy delivery device
2 delivers a sufficient amount of energy to create a tightening of the lower esophageal
3 sphincter while preserving a blood supply to the sphincter.

1 92. The method of claim 83, wherein the energy delivery device
2 creates a tightening of the lower esophageal sphincter while creating submucosal
3 lesions in the sphincter.

1 93. The method of claim 83, wherein the expandable member is
2 expandable.

WO 99/35986

PCT/US99/00693

1 94. The method of claim 73, wherein the expandable member is
2 introduced in the lower esophageal sphincter in an unexpanded state.

1 95. The method of claim 94, wherein the expandable member is
2 expanded to an expanded state when positioned in the sphincter.

1 96. The method of claim 93, wherein the expandable member is a
2 balloon.

1 97. The method of claim 93, further comprising:
2 an electrolytic solution housed in an expanded expandable member.

1 98. The method of claim 83, wherein the energy delivery device is an
2 RF electrode.

1 99. The method of claim 98, further comprising:
2 an RF energy source coupled to the RF electrode.

1 100. The method of claim 83, wherein the energy delivery device is a
2 microwave antenna.

1 101. The method of claim 100, further comprising:
2 a microwave energy source coupled to the microwave antenna.

1 102. The method of claim 83, wherein the energy delivery device is a
2 waveguide.

1 103. The method of claim 102, further comprising:
2 a light source coupled to the waveguide.

WO 99/35986

PCT/US99/00693

1 104. The method of claim 83, wherein the light source is a laser.

1 105. The method of claim 83, wherein the energy delivery device is an
2 acoustical transducer.

1 106. The method of claim 105, further comprising:
2 an acoustical energy source coupled to the acoustical transducer.

1 107. The method of claim 83, wherein the energy delivery device is a
2 resistive heating device.

1 108. The method of claim 83, wherein the energy delivery device is
2 delivered to the sphincter transorally without an endoscope.

1 109. The method of claim 83, wherein the energy delivery device is
2 delivered to the sphincter with an endoscope.

1 110. The method of claim 83, wherein the sphincter is the lower
2 esophageal sphincter.

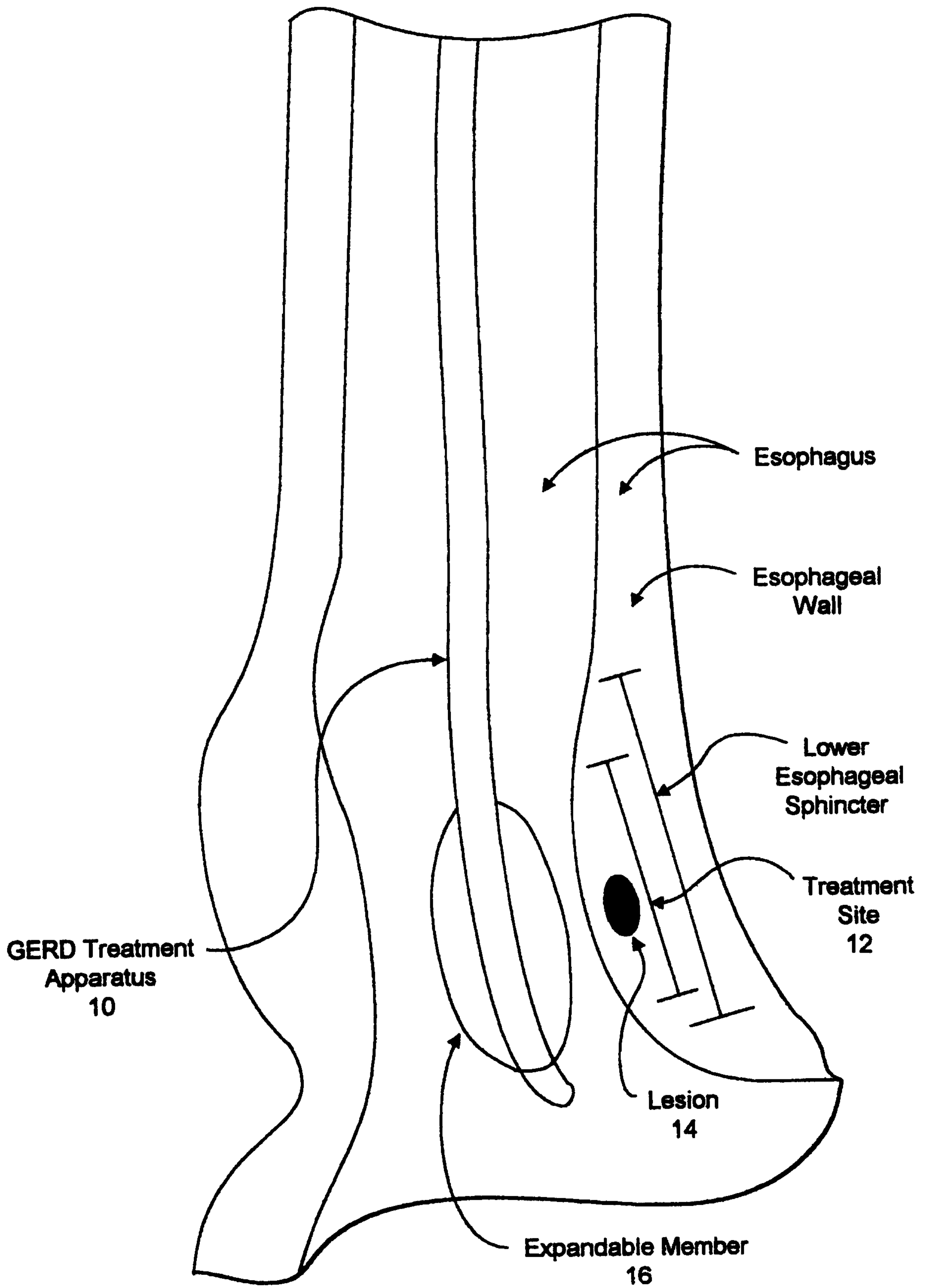

FIG. 1

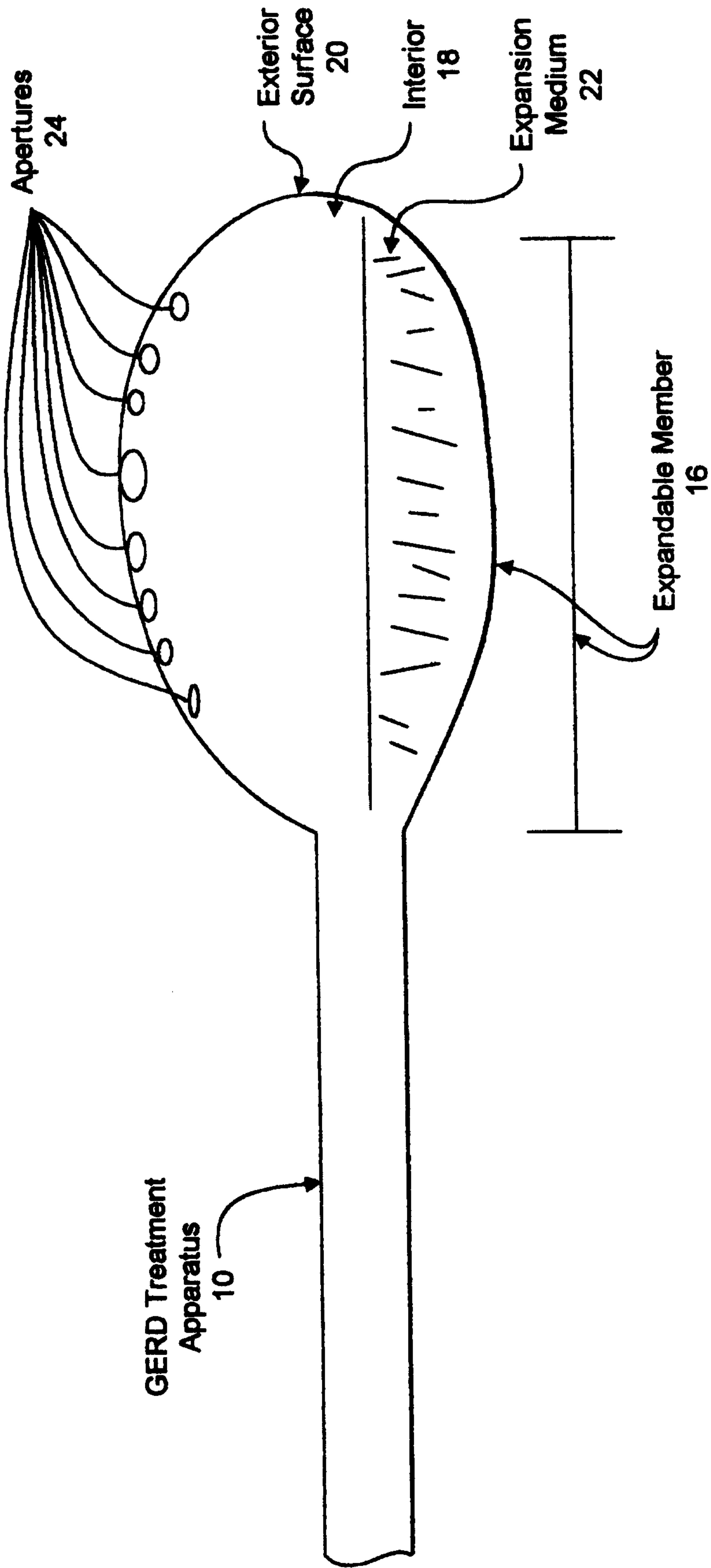

FIG. 2

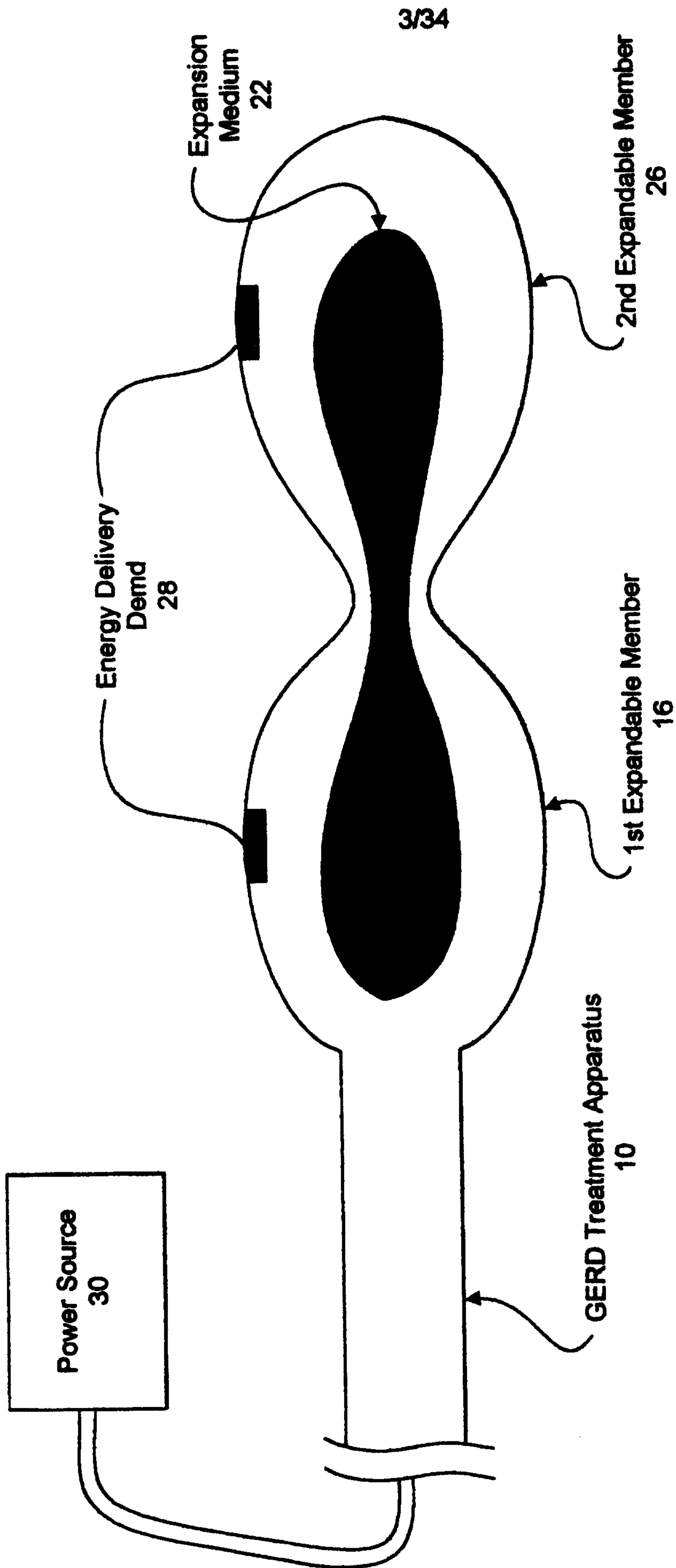

FIG. 3

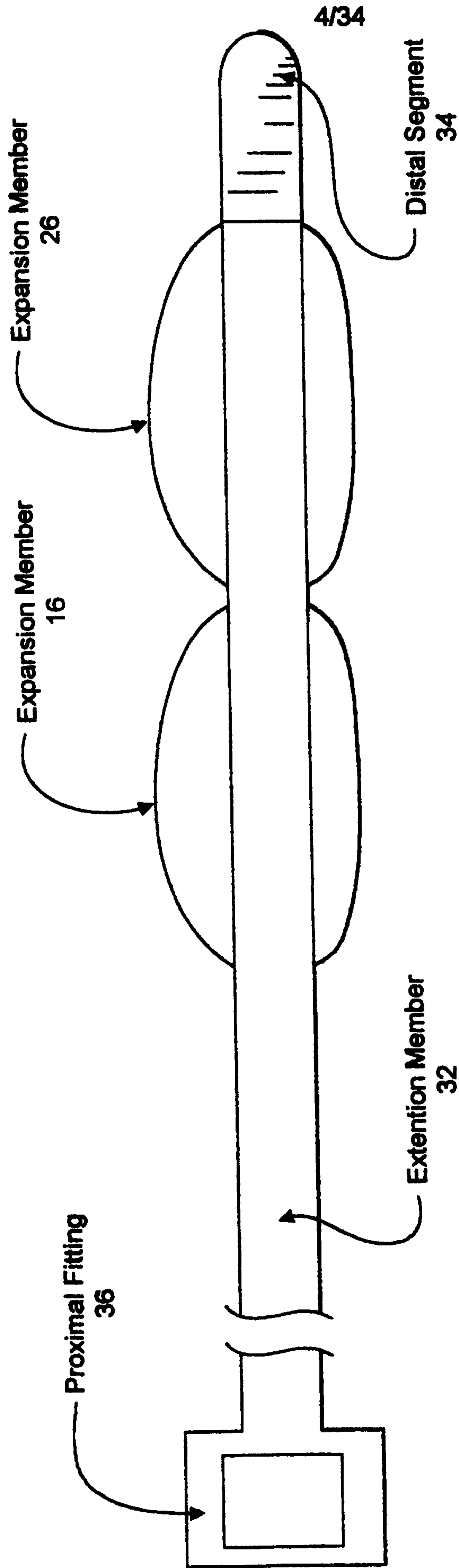

FIG. 4

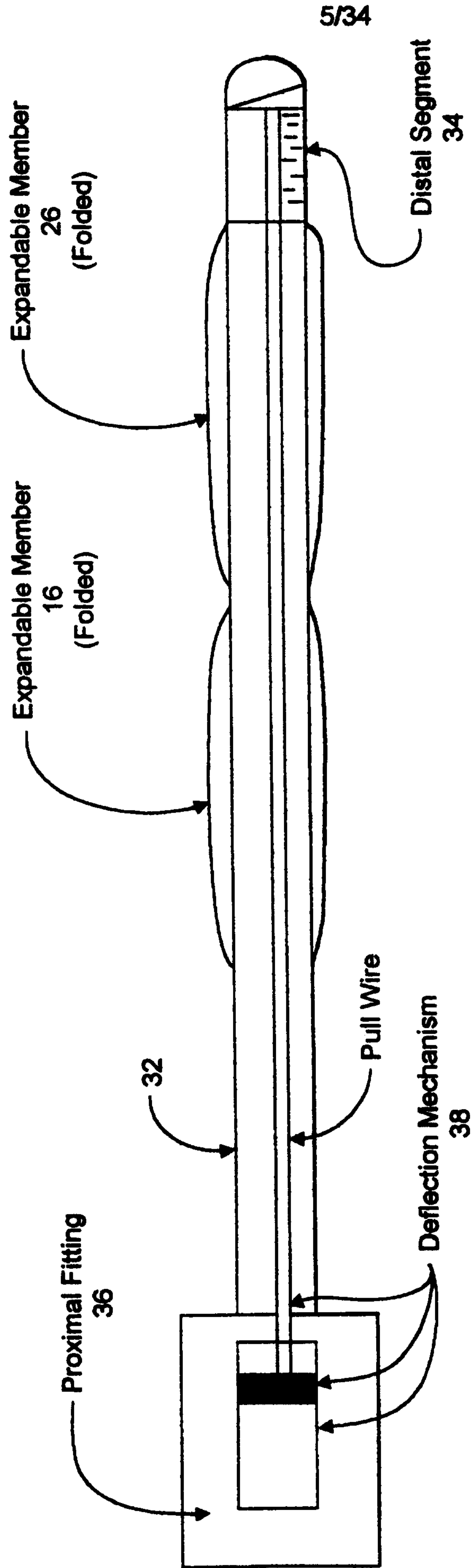

FIG. 5

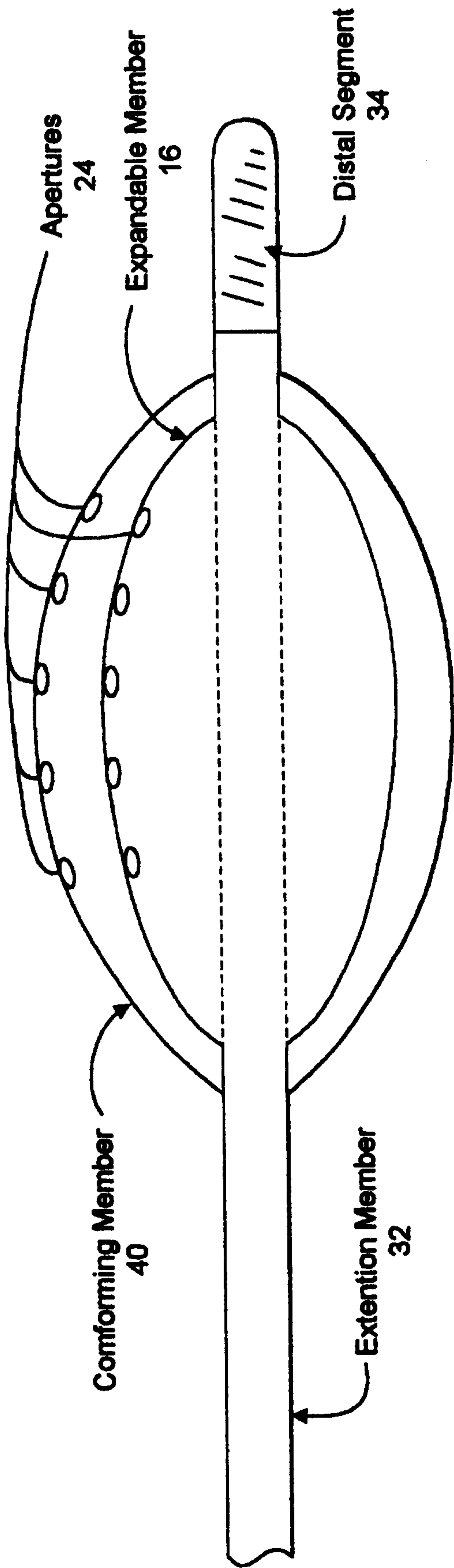

FIG. 6A

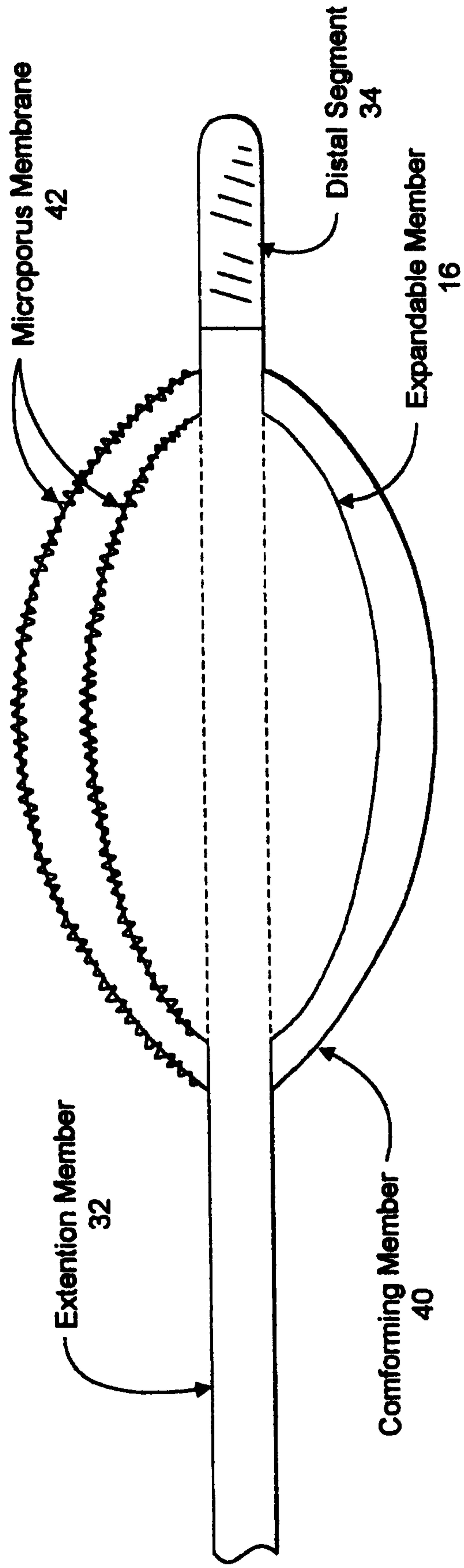

FIG. 6B

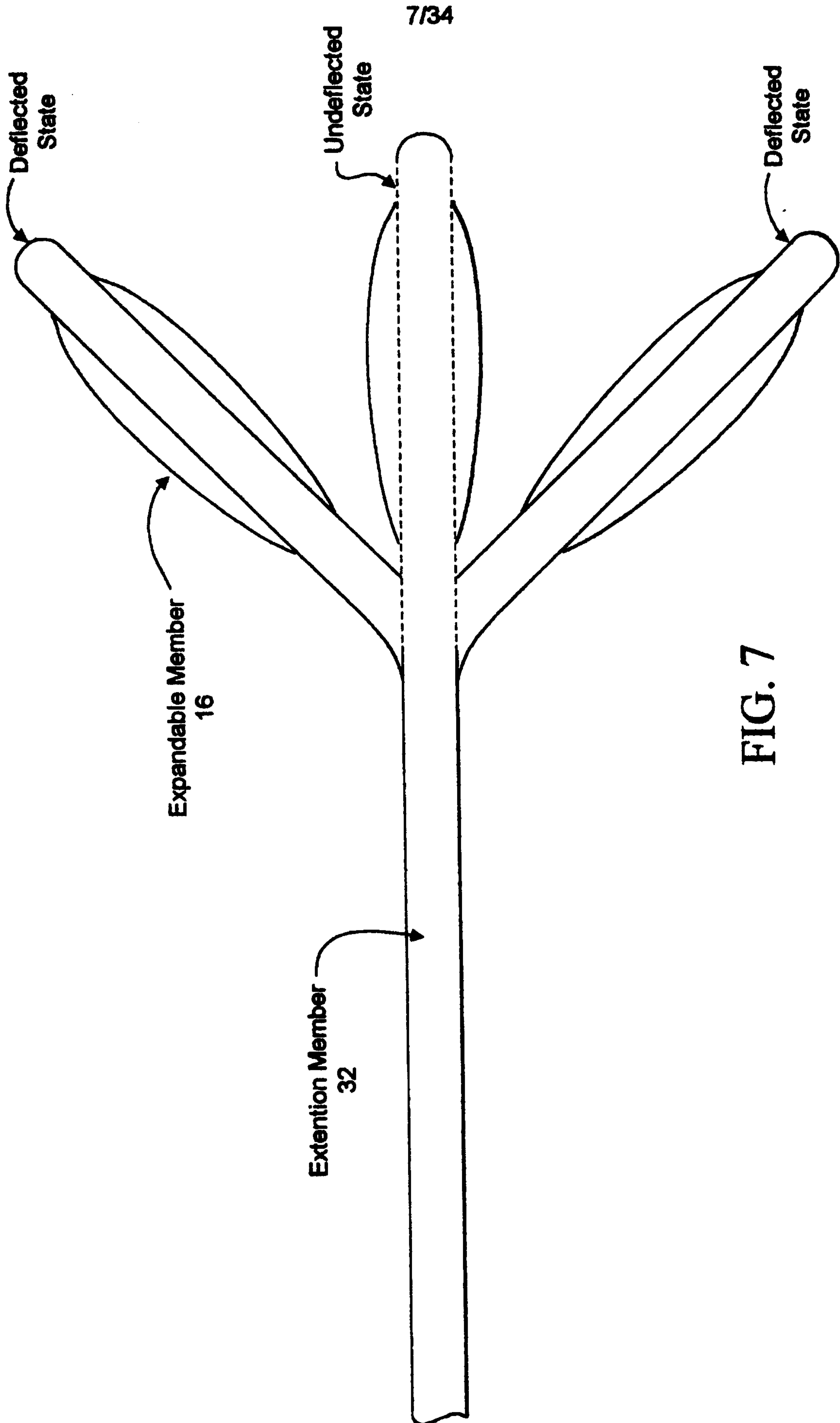

FIG. 7

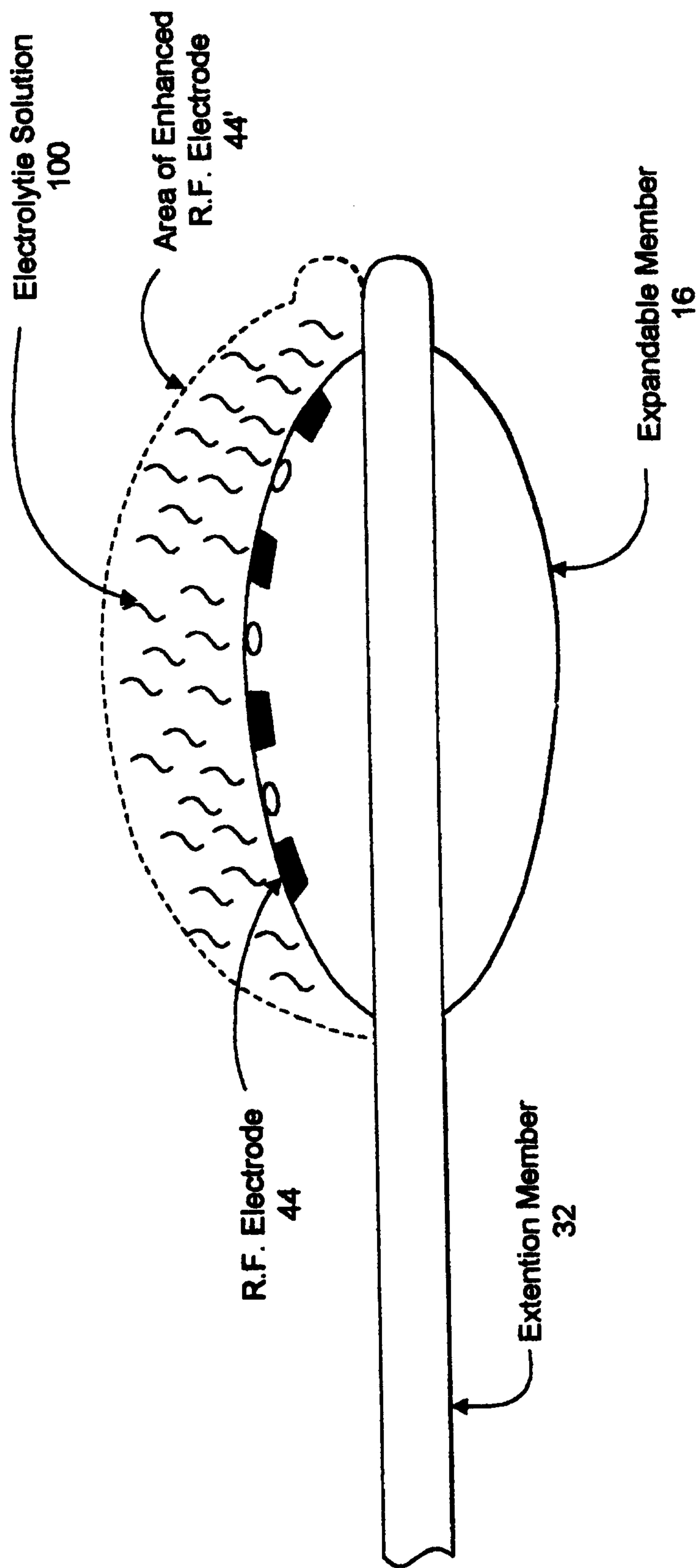

FIG. 8

9/34

Radial Electrode Pattern

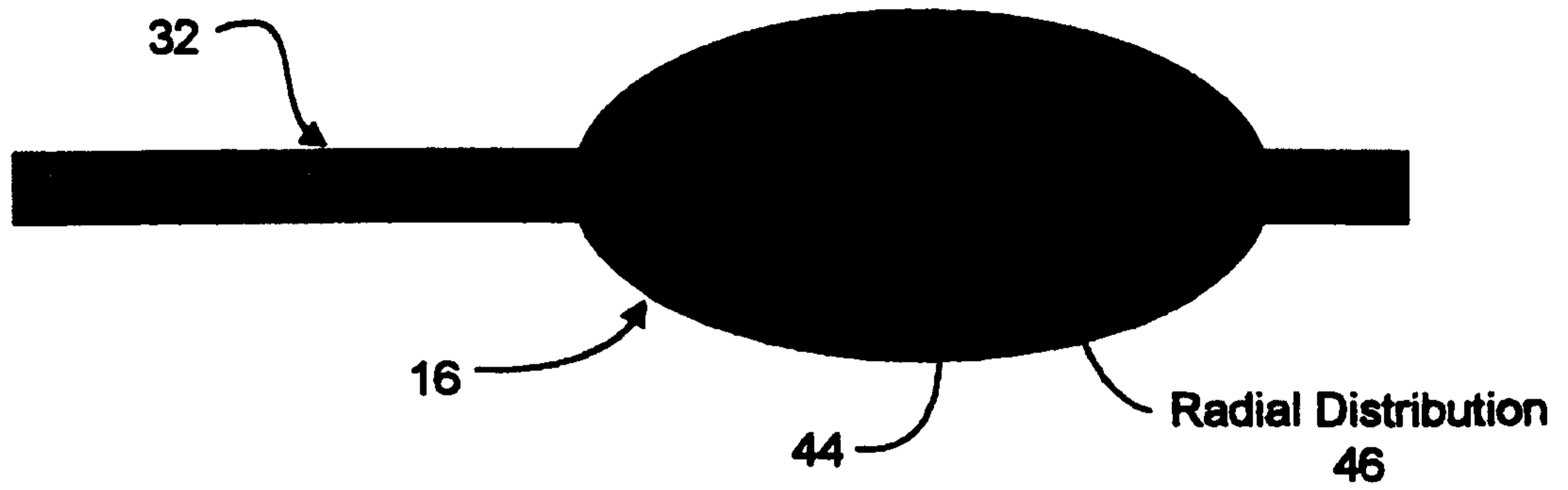

FIG. 9A

Longitudinal Electrode Pattern

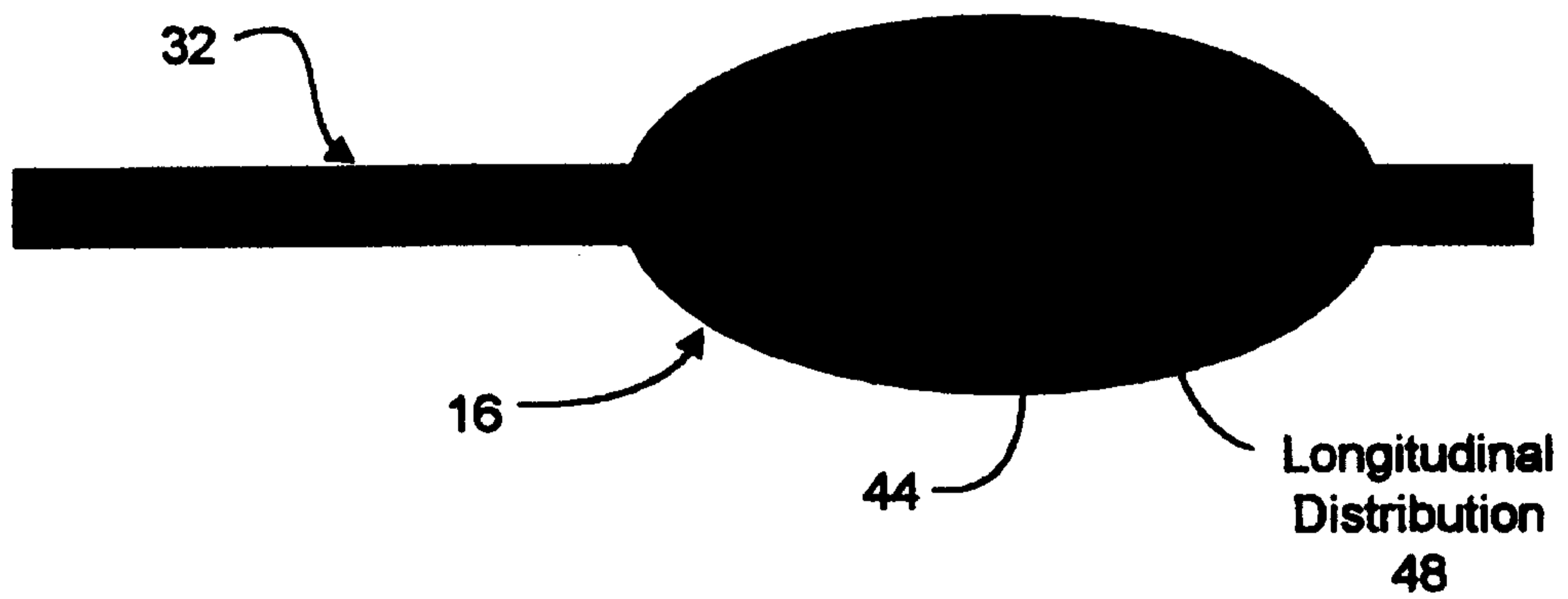

FIG. 9B

Spiral Electrode Pattern

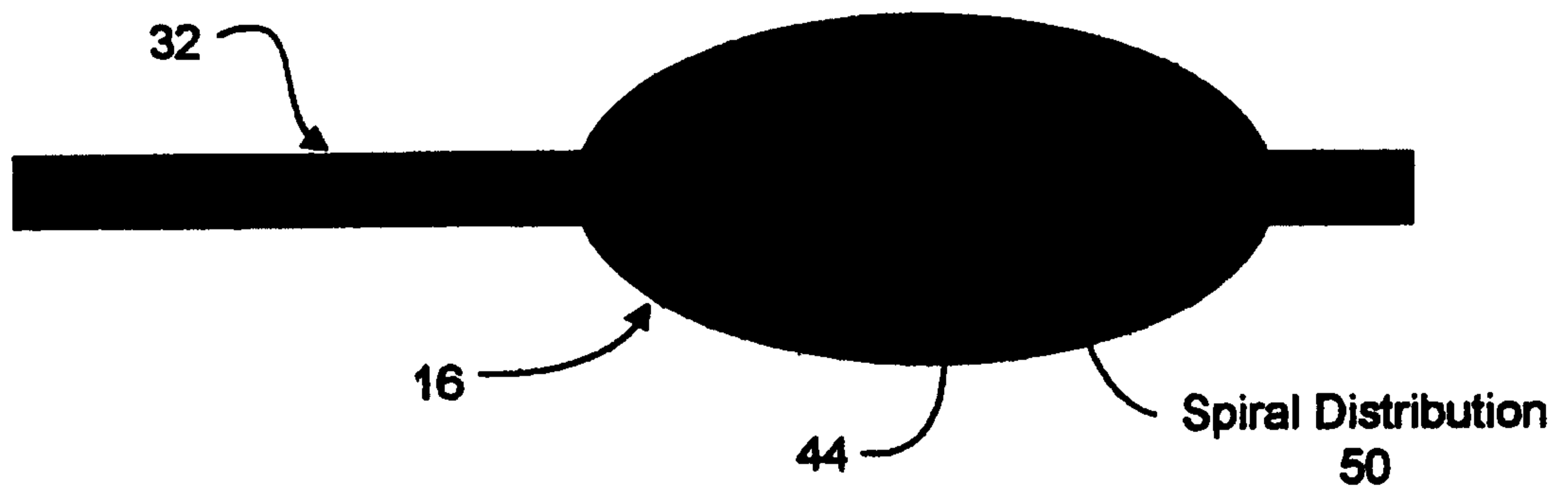

FIG. 9C

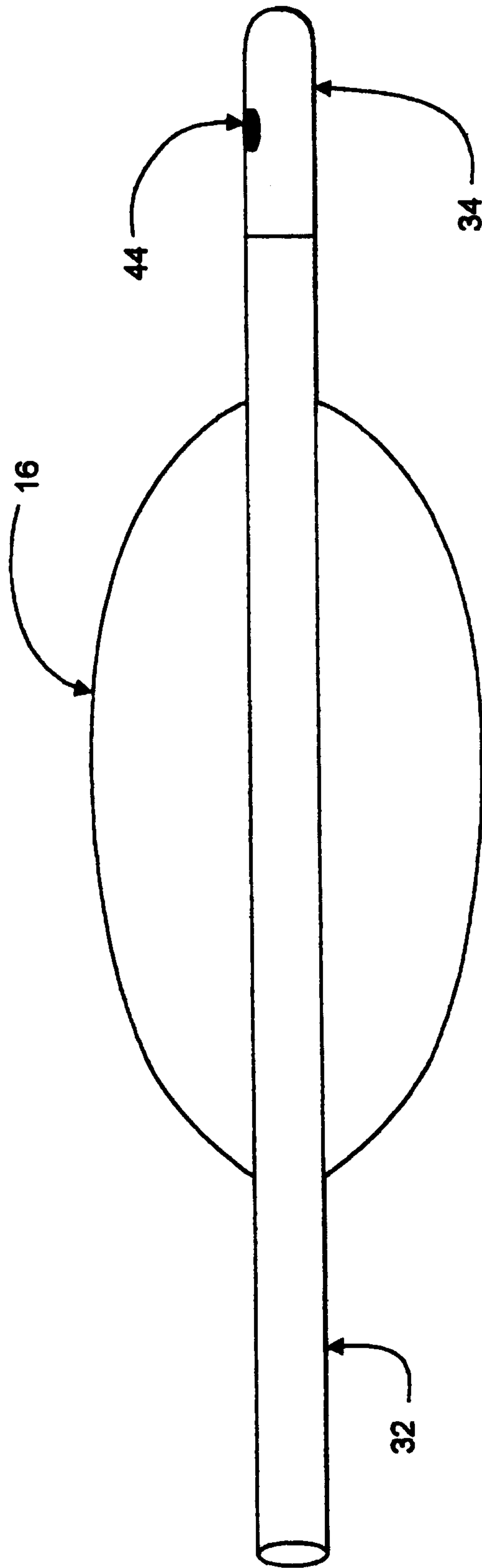

FIG. 10

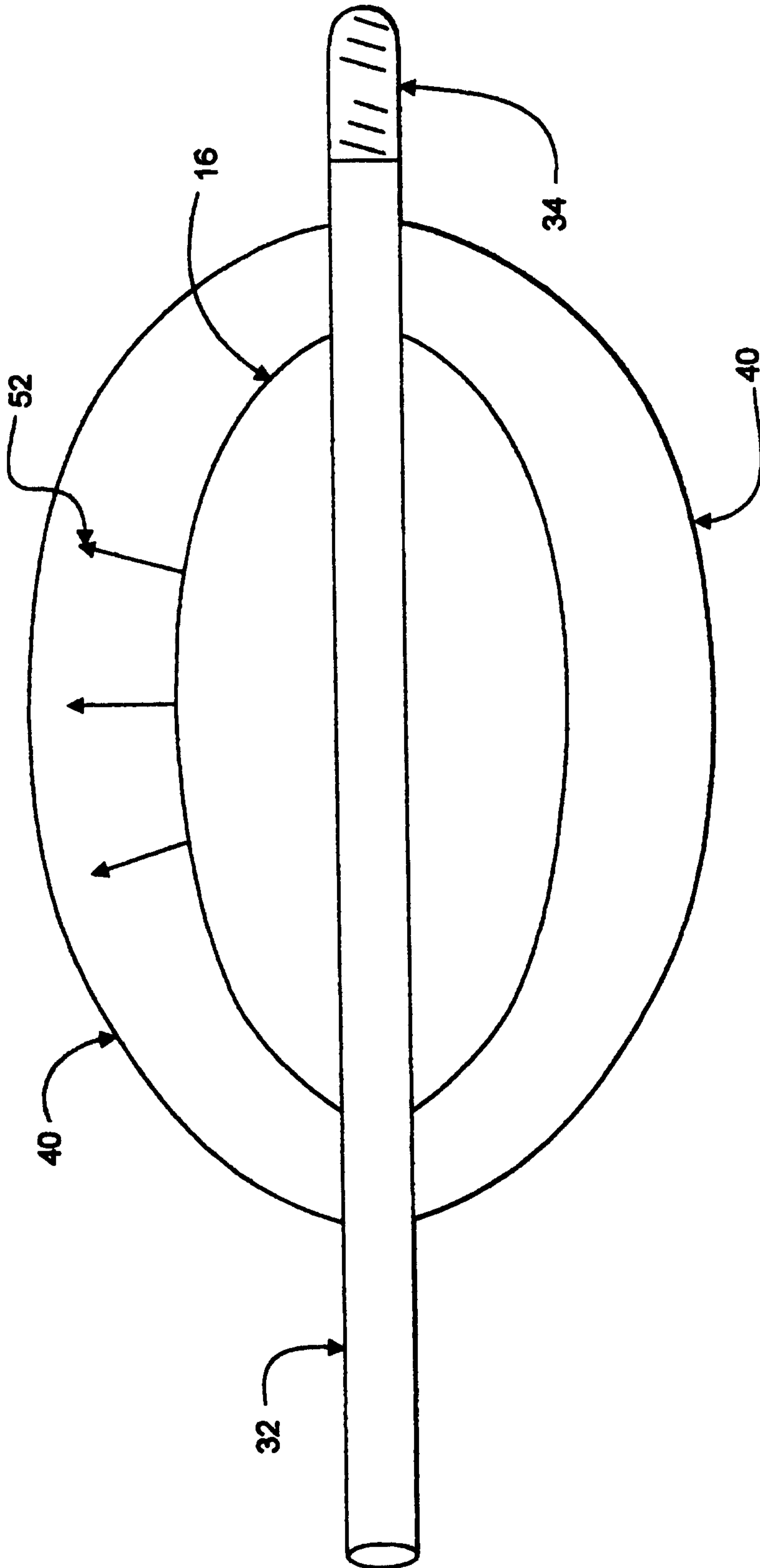

FIG. 11

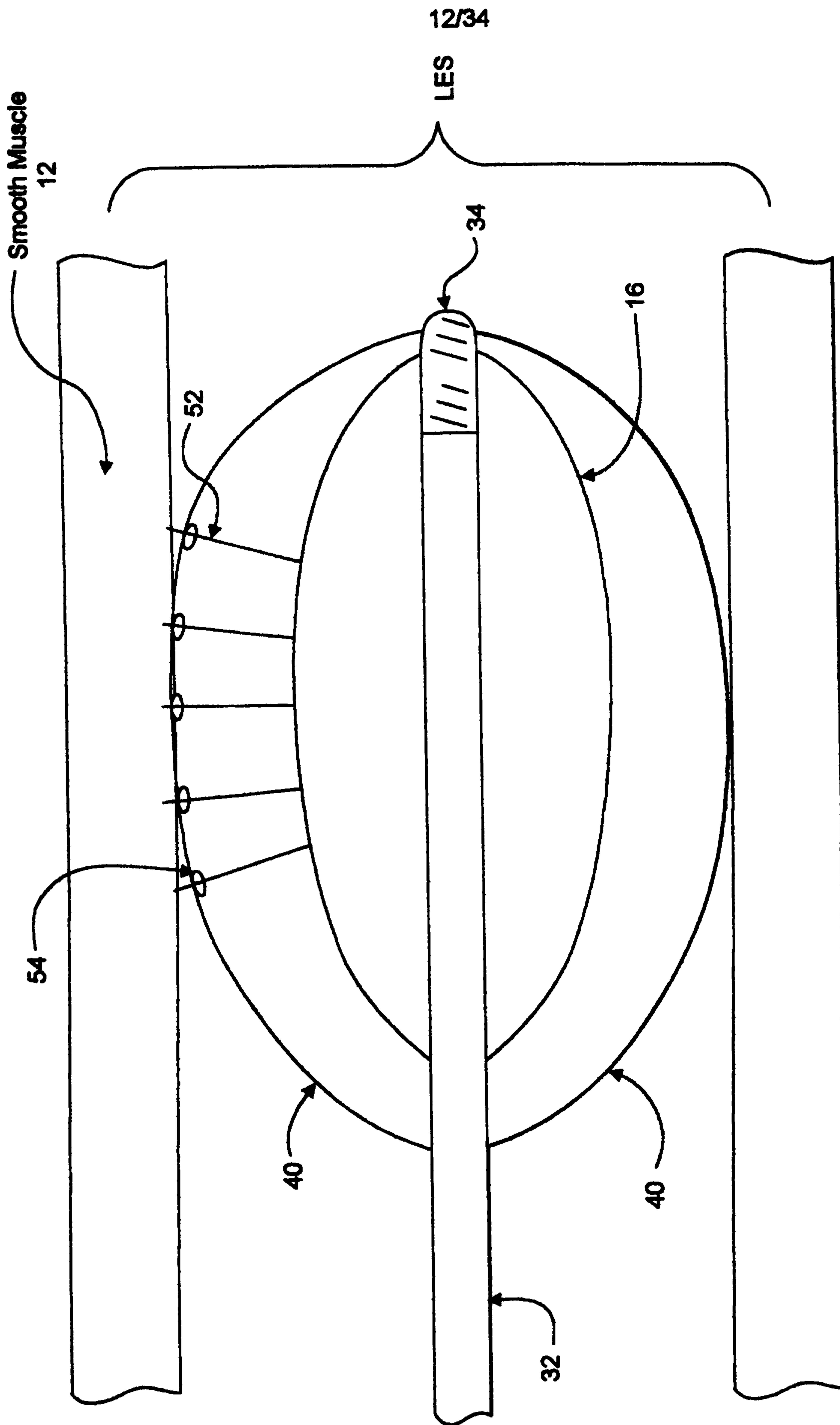

FIG. 12

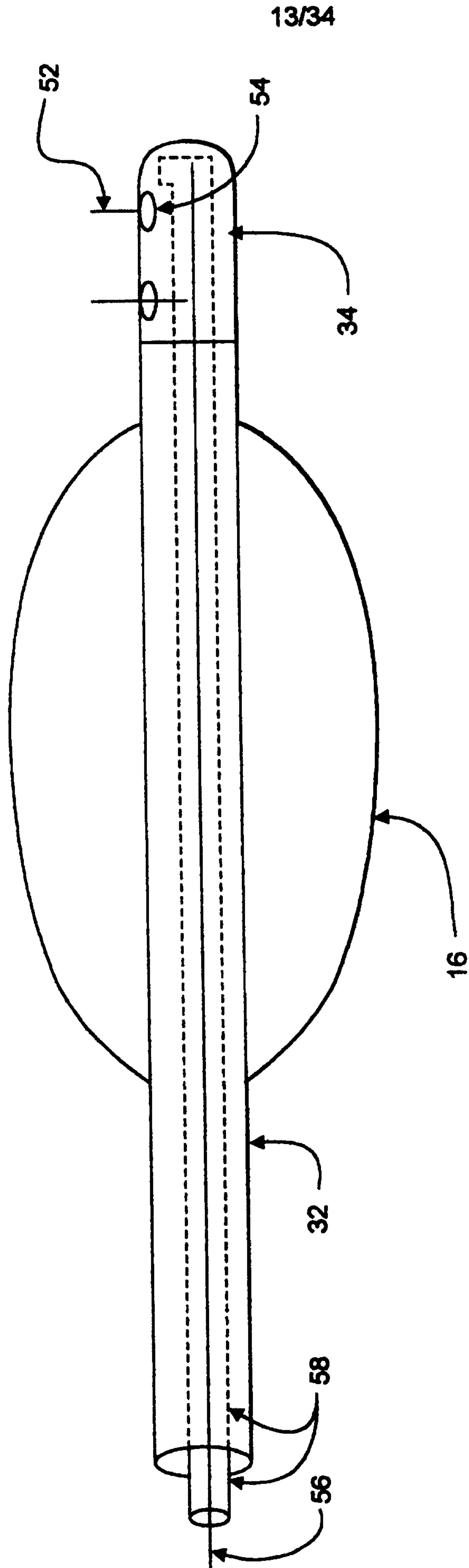

FIG. 13

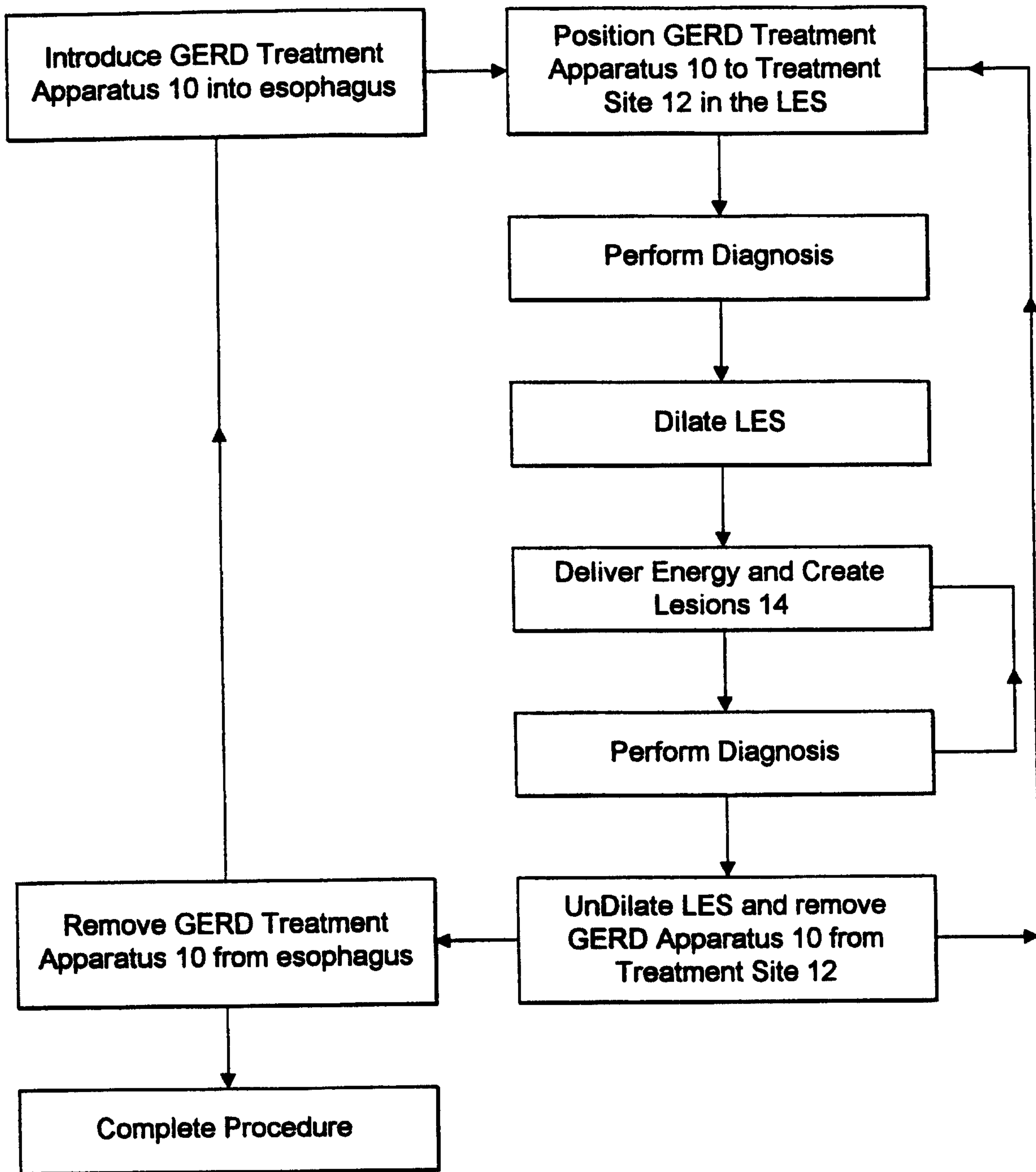

FIG. 14

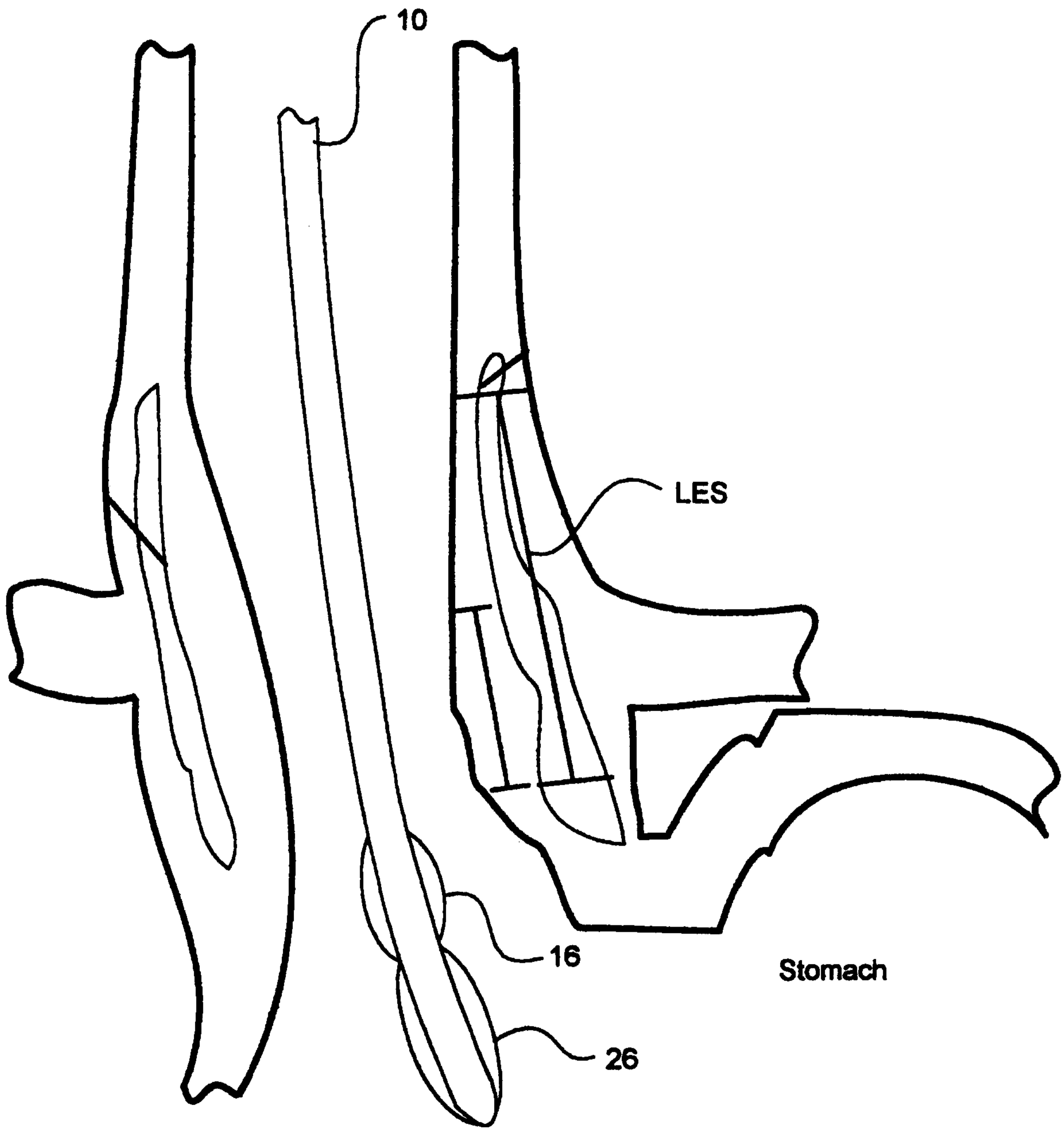

FIG. 15A

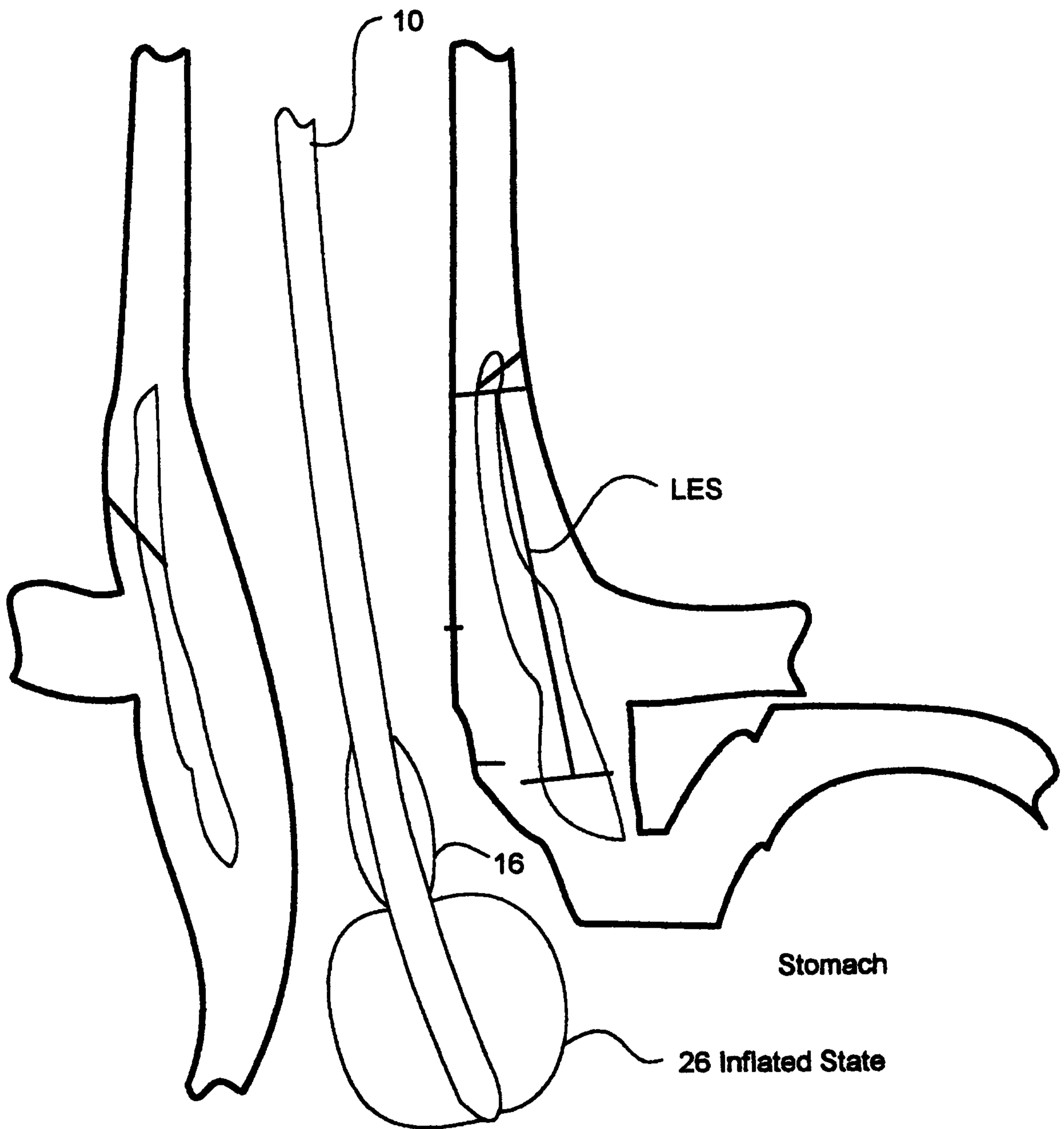

FIG. 15B

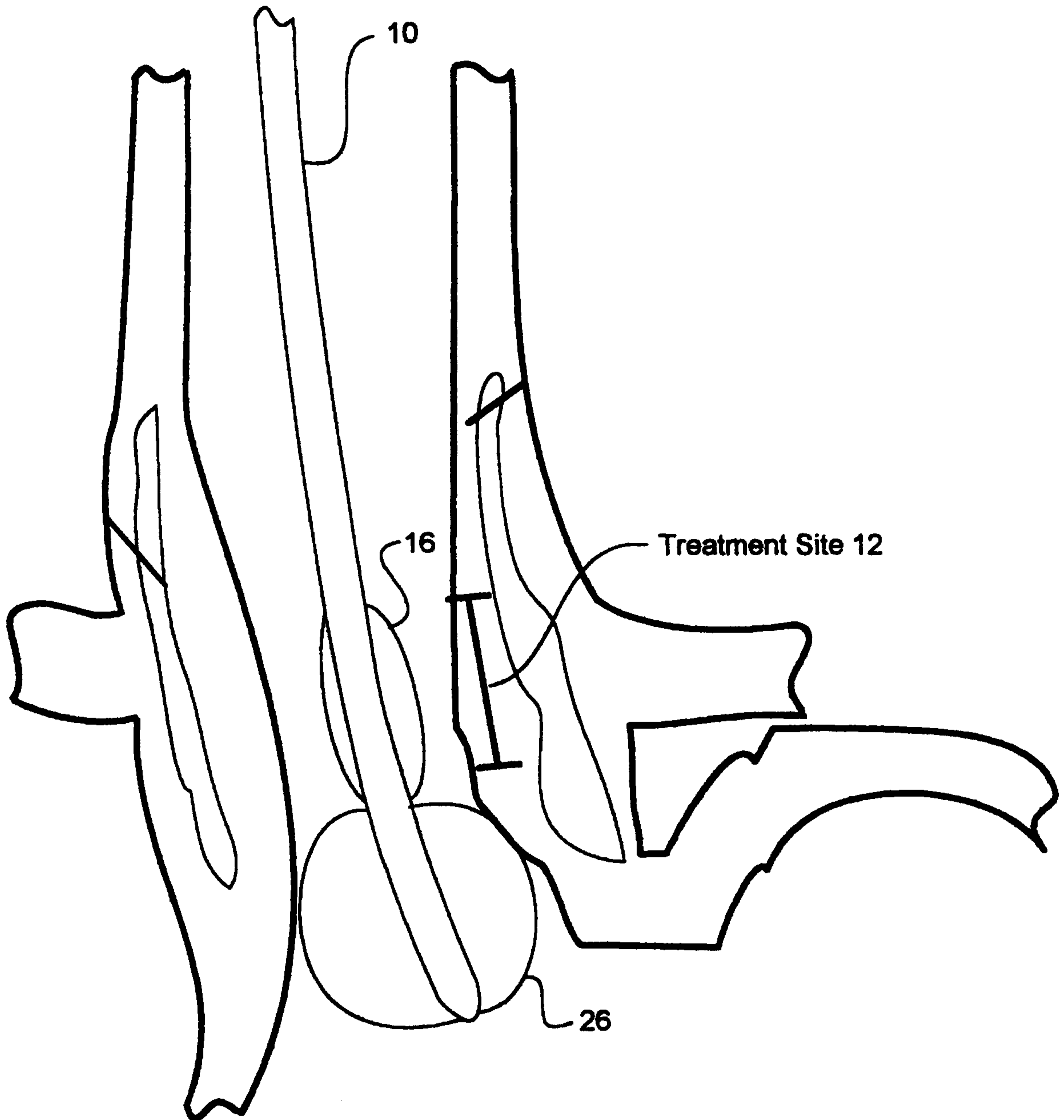

FIG. 15C

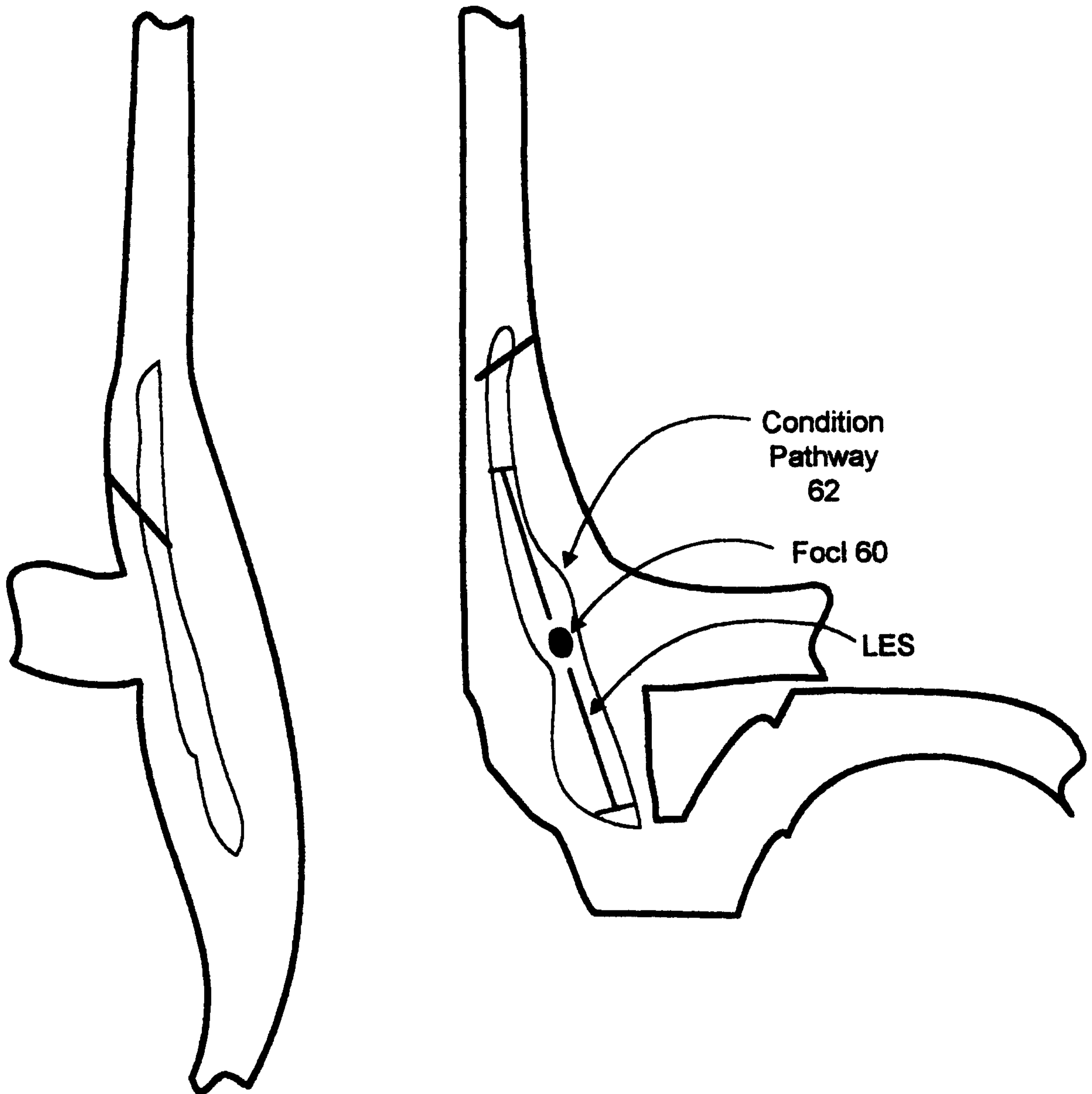

FIG. 16

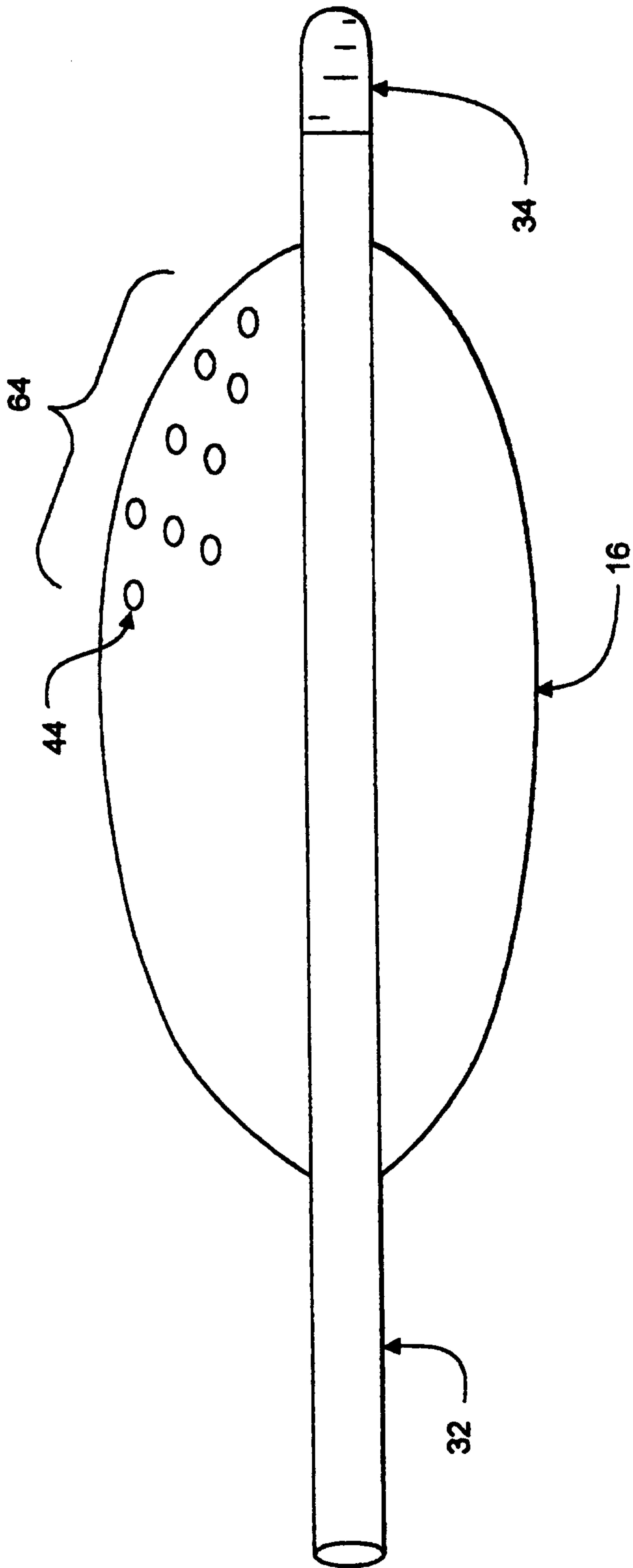

FIG. 17

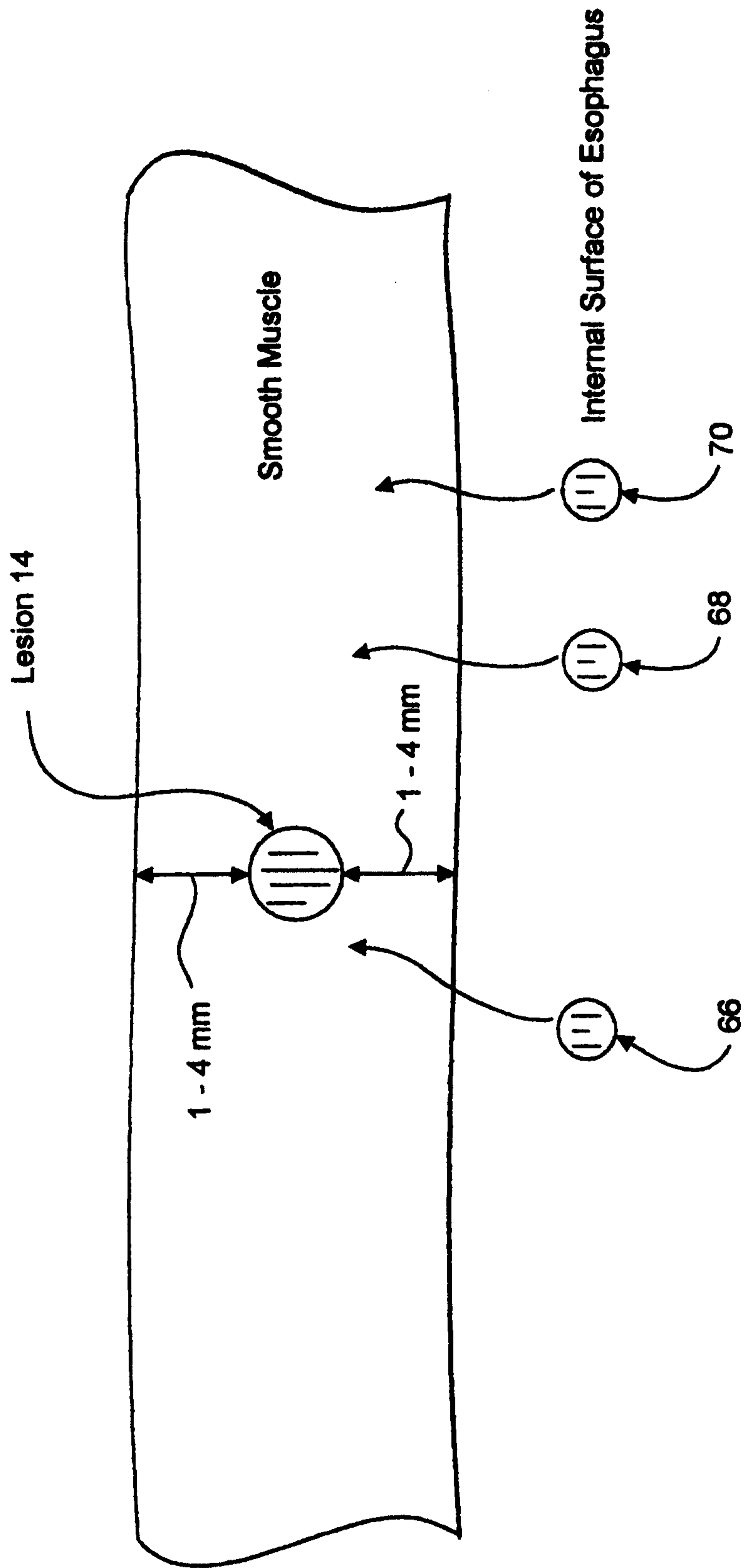

FIG. 18

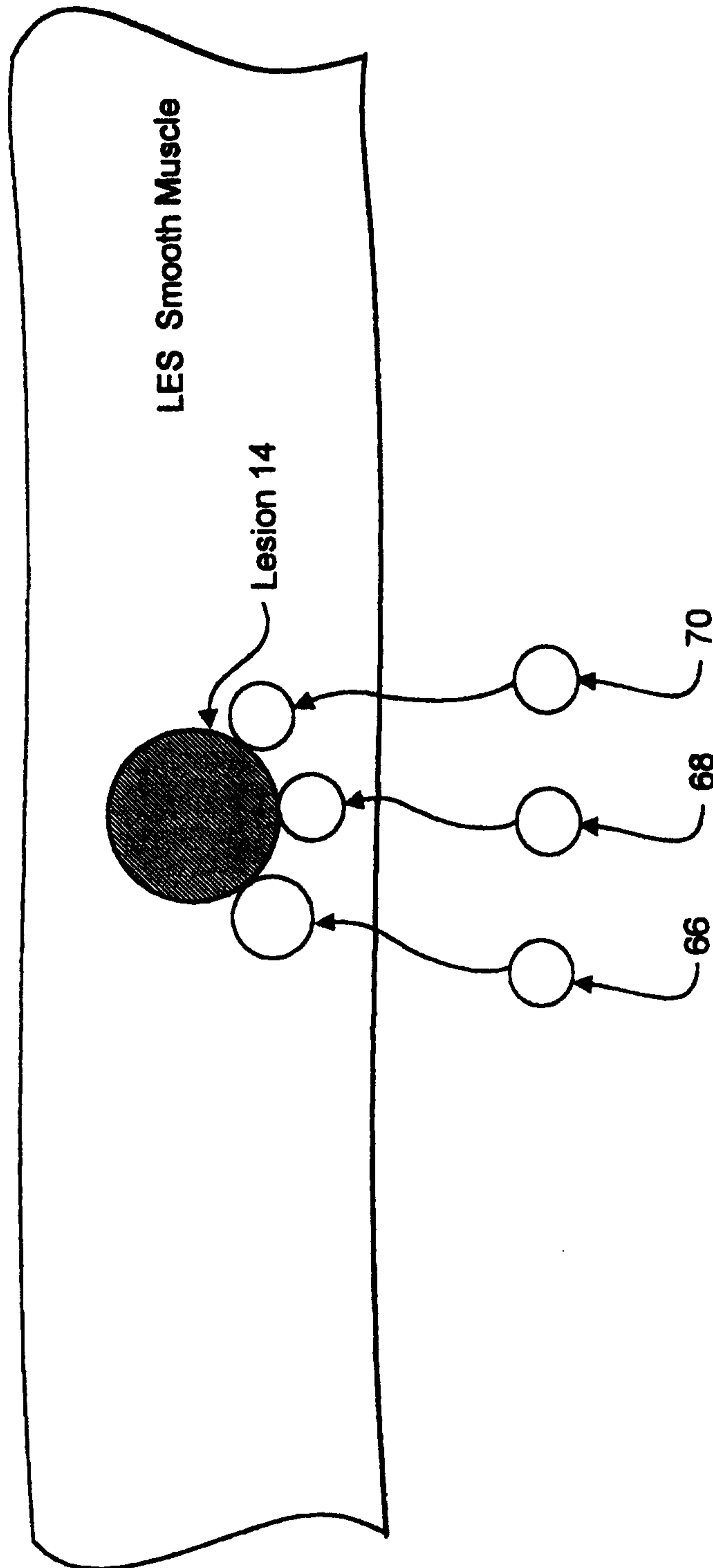

FIG. 19A

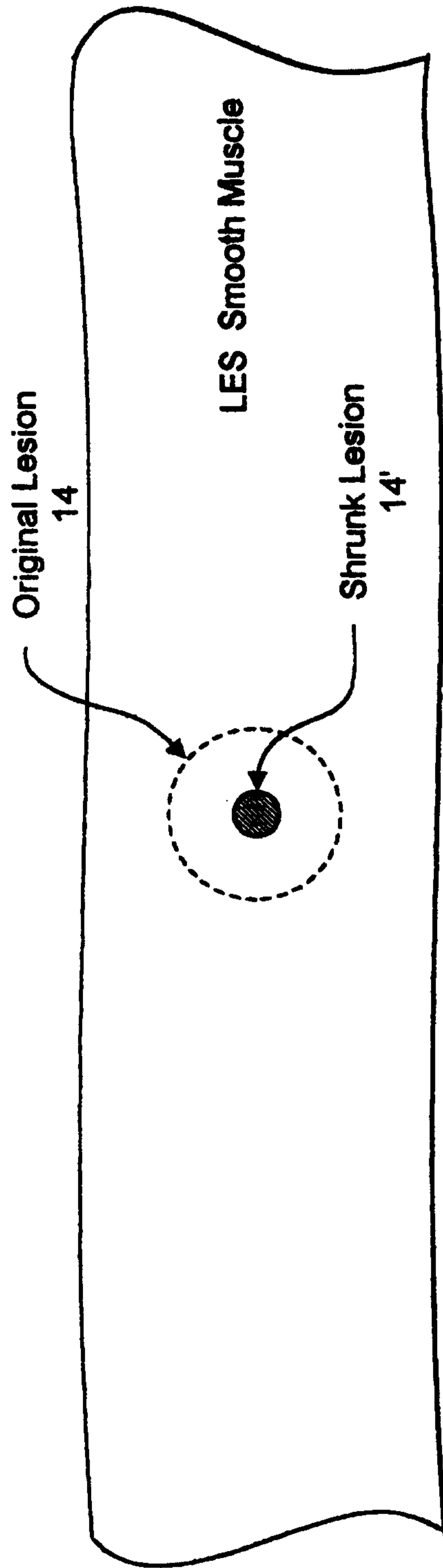

FIG. 19B

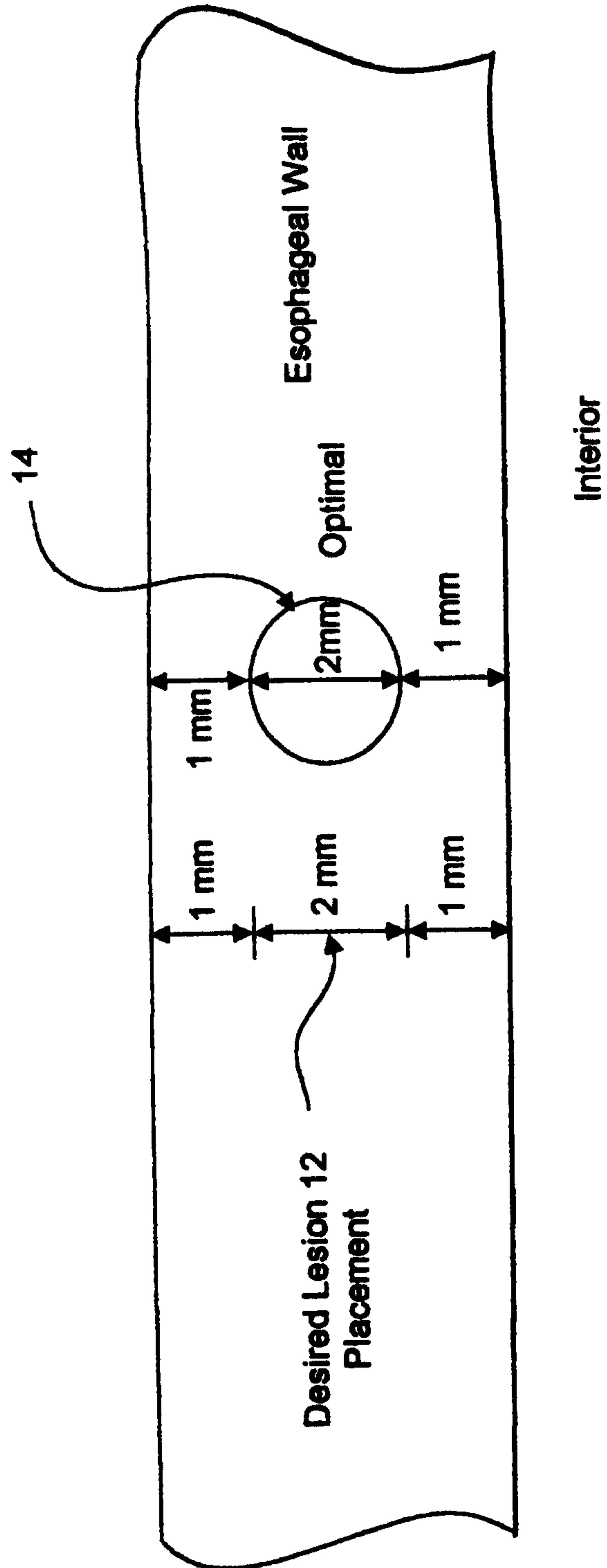

FIG. 20

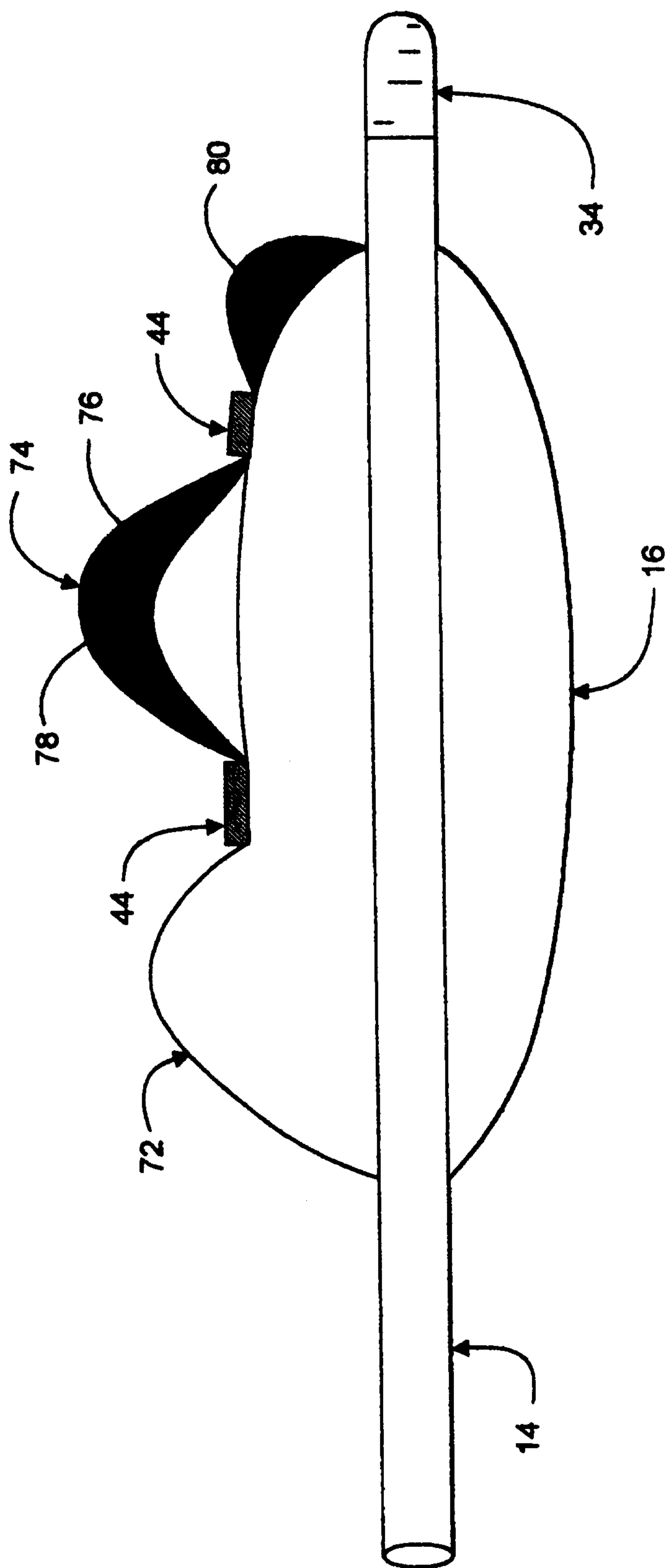

FIG. 21

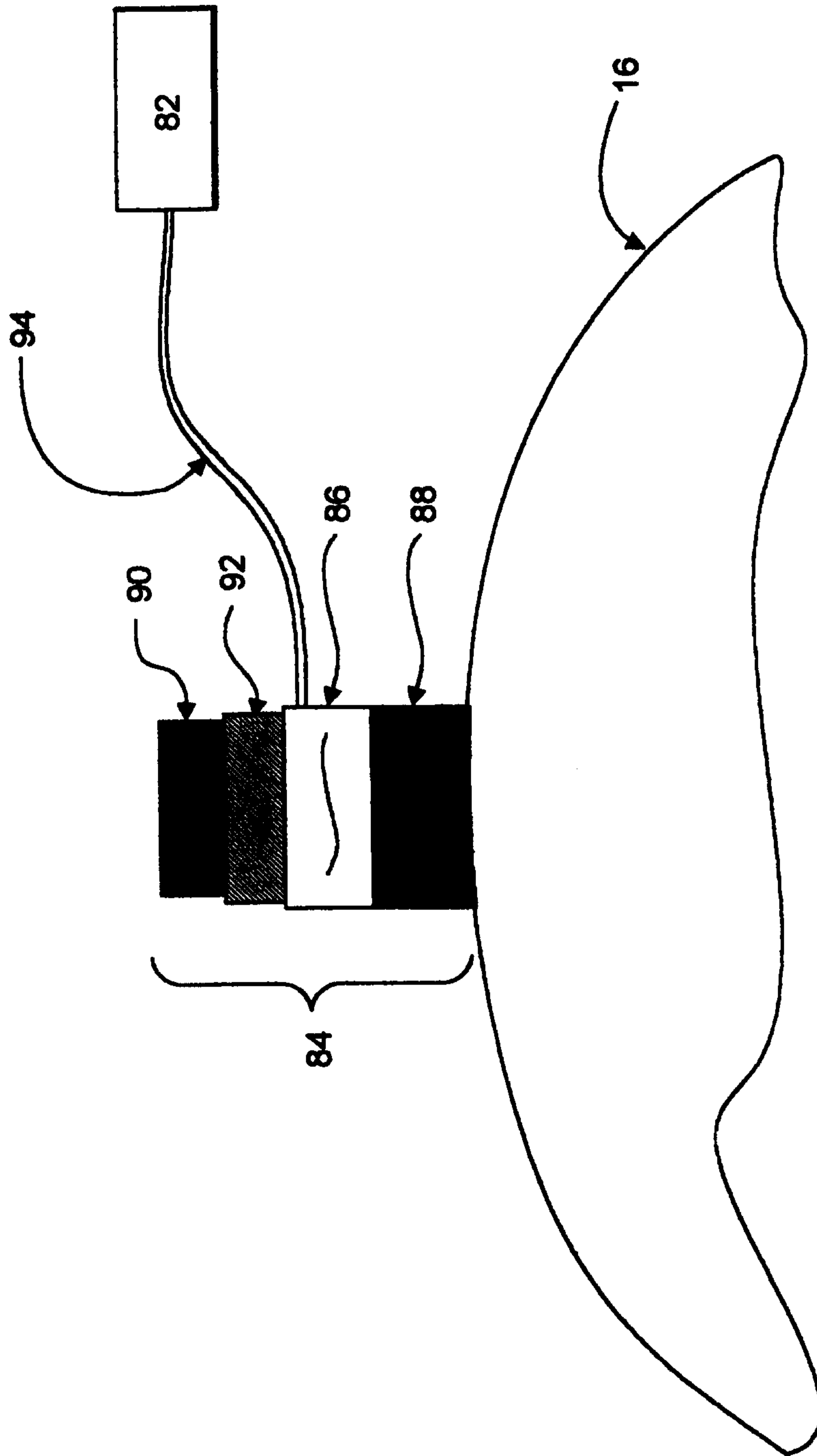

FIG. 22

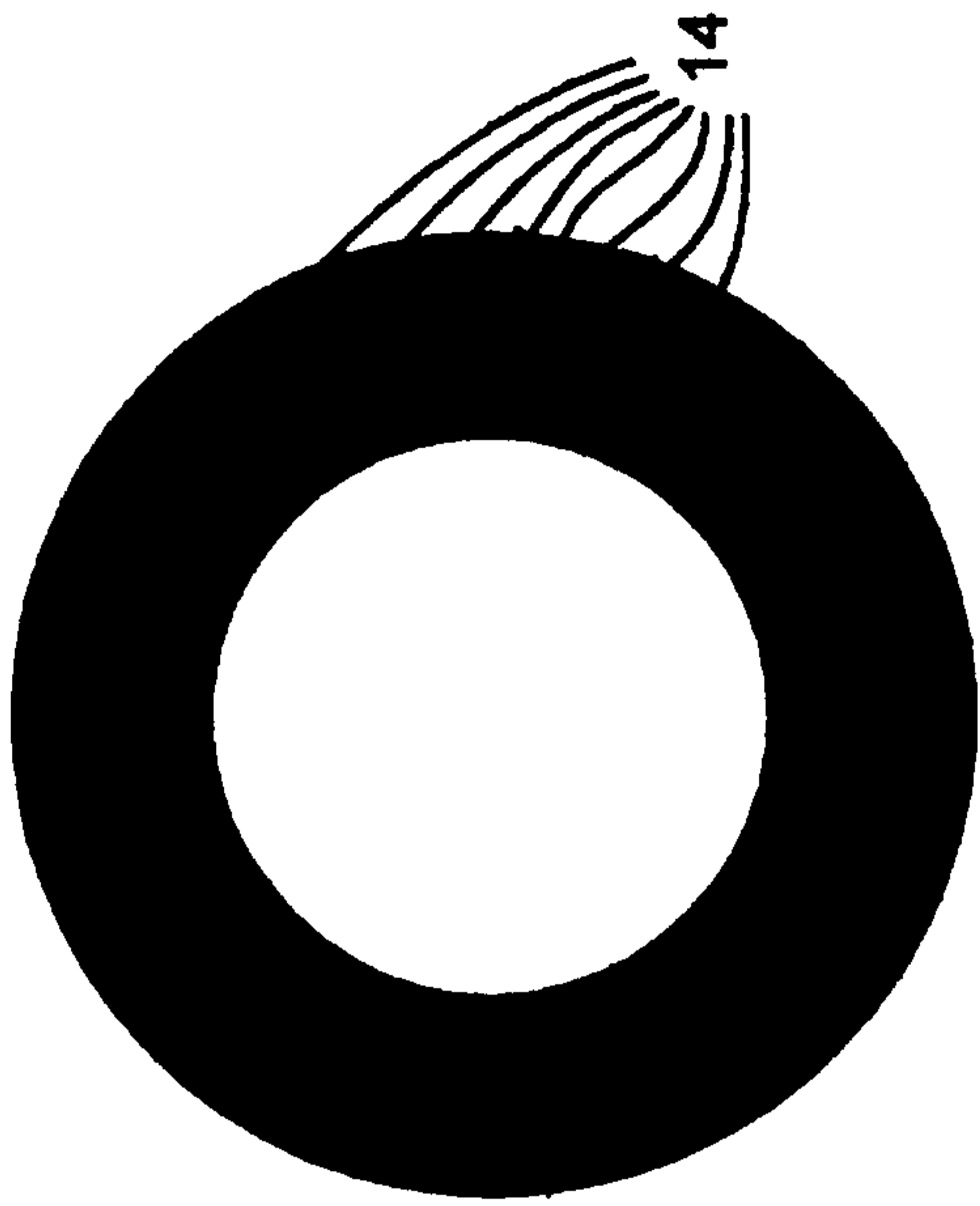

FIG. 23B

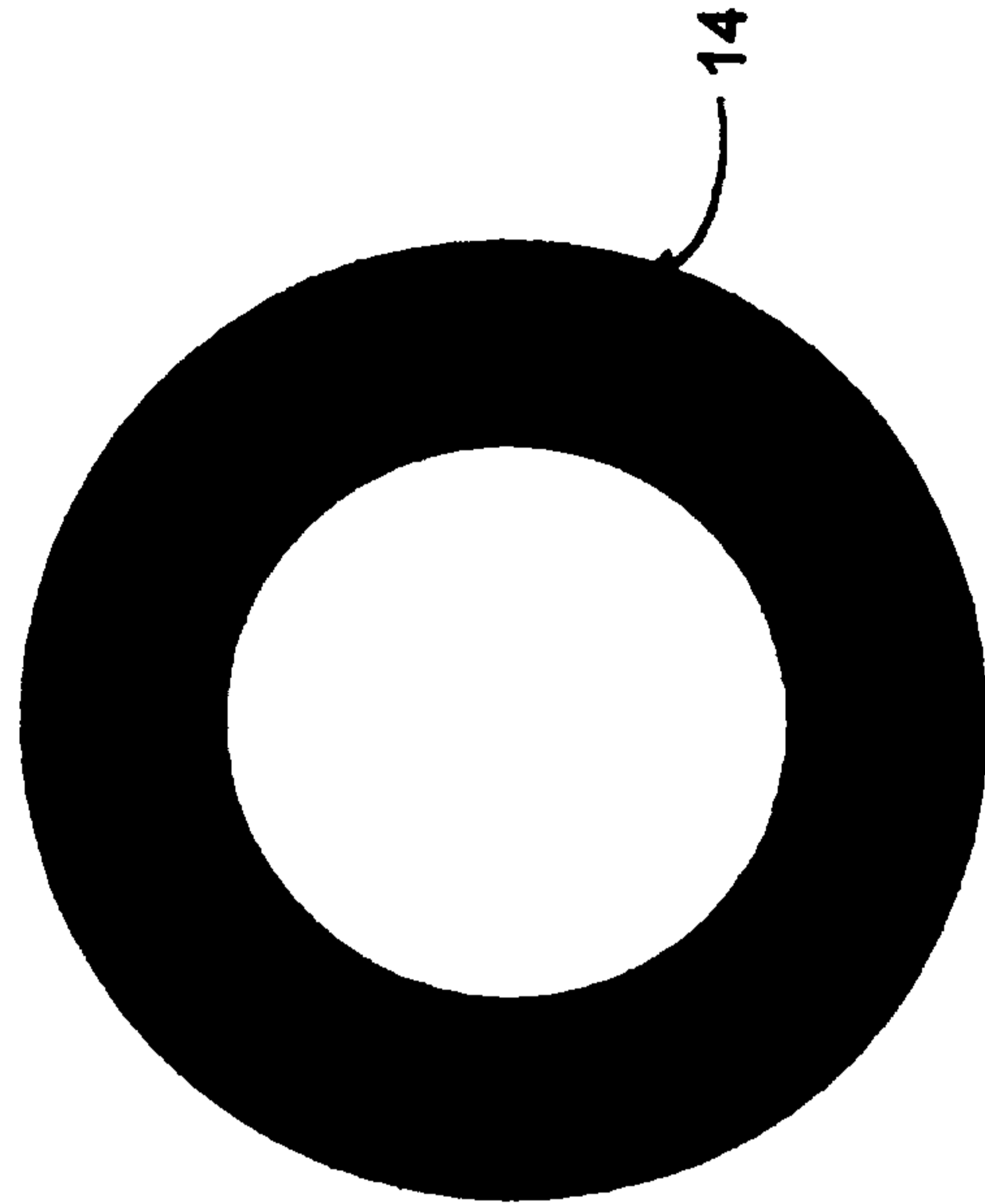

FIG. 23D

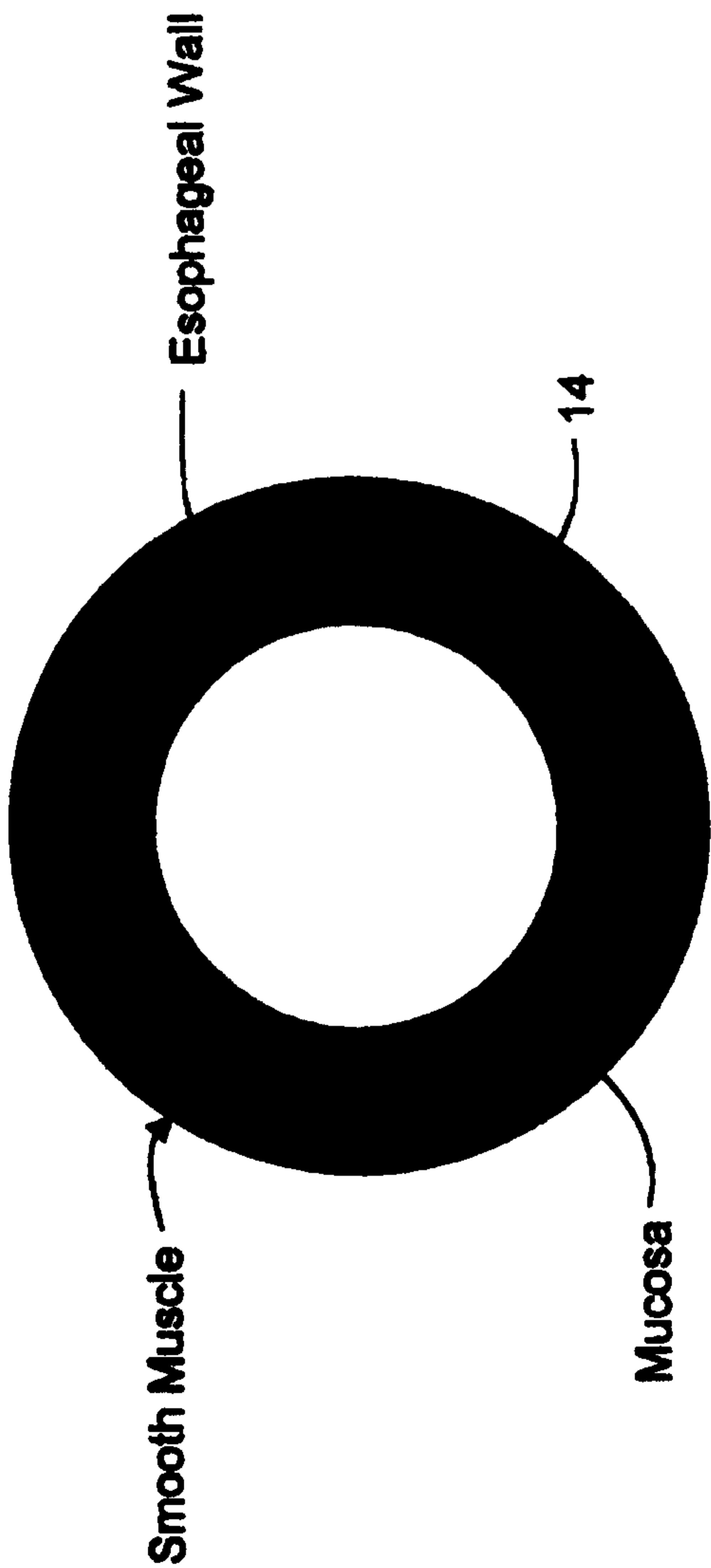

FIG. 23A

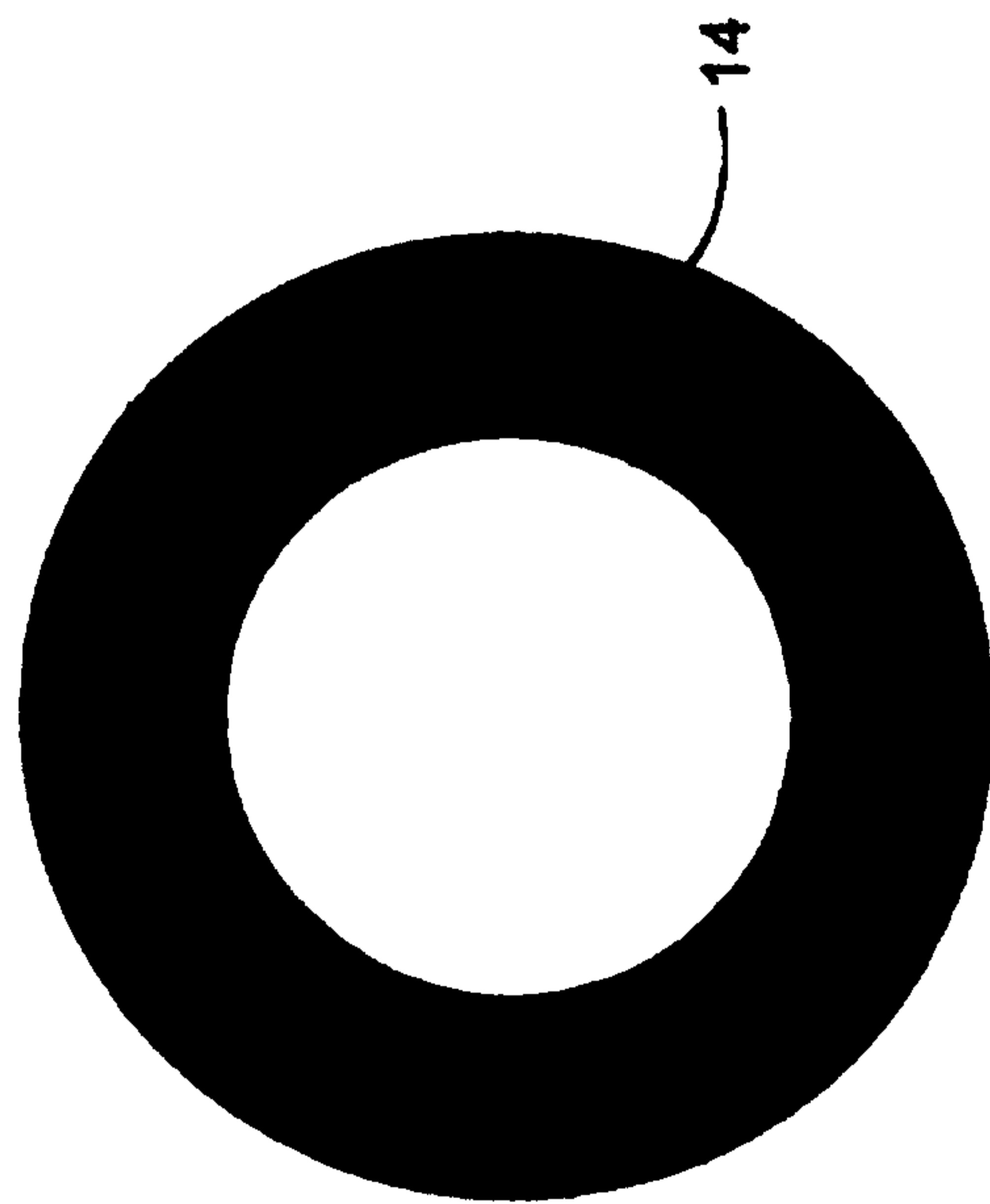

FIG. 23C

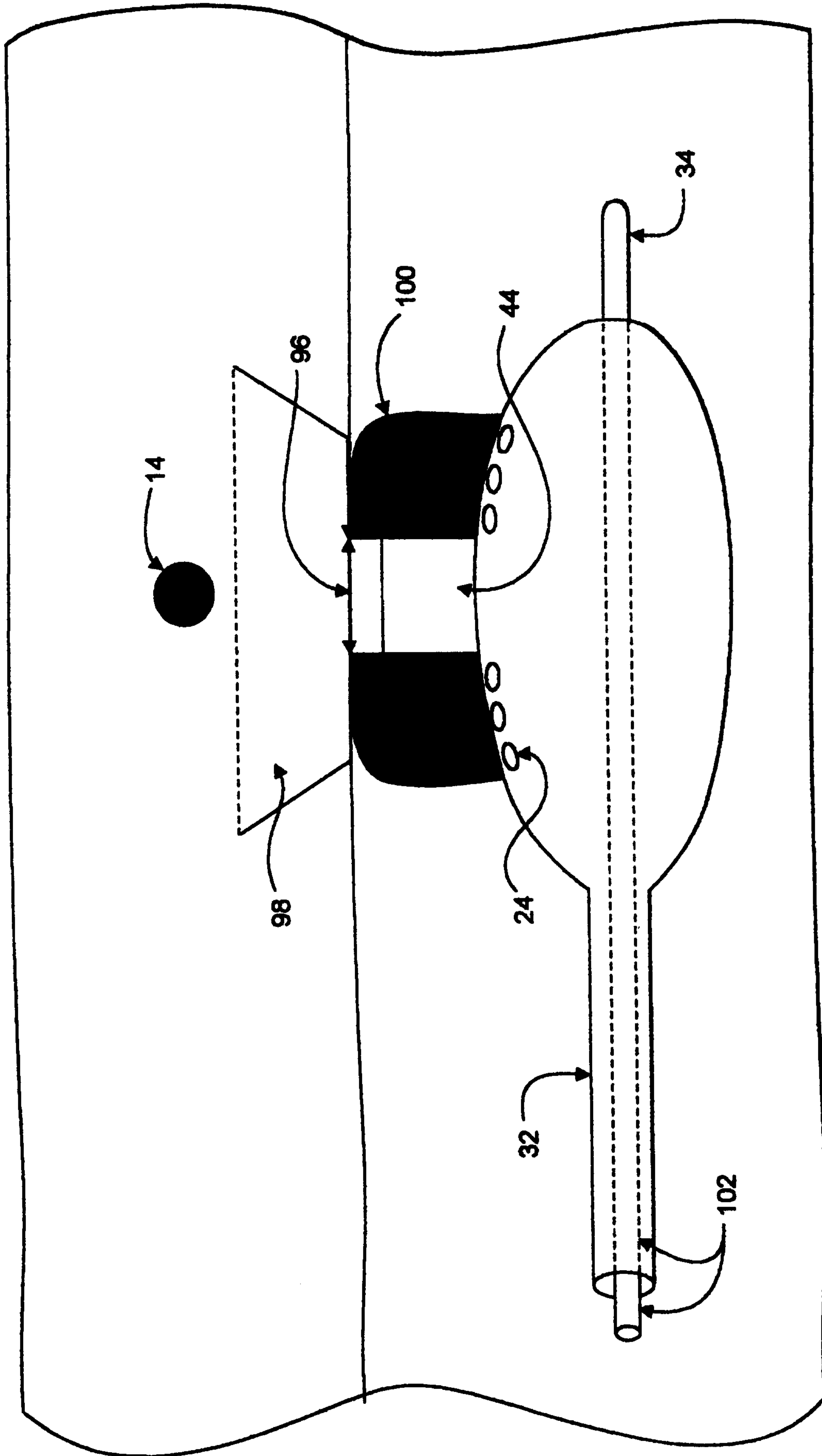

FIG. 24

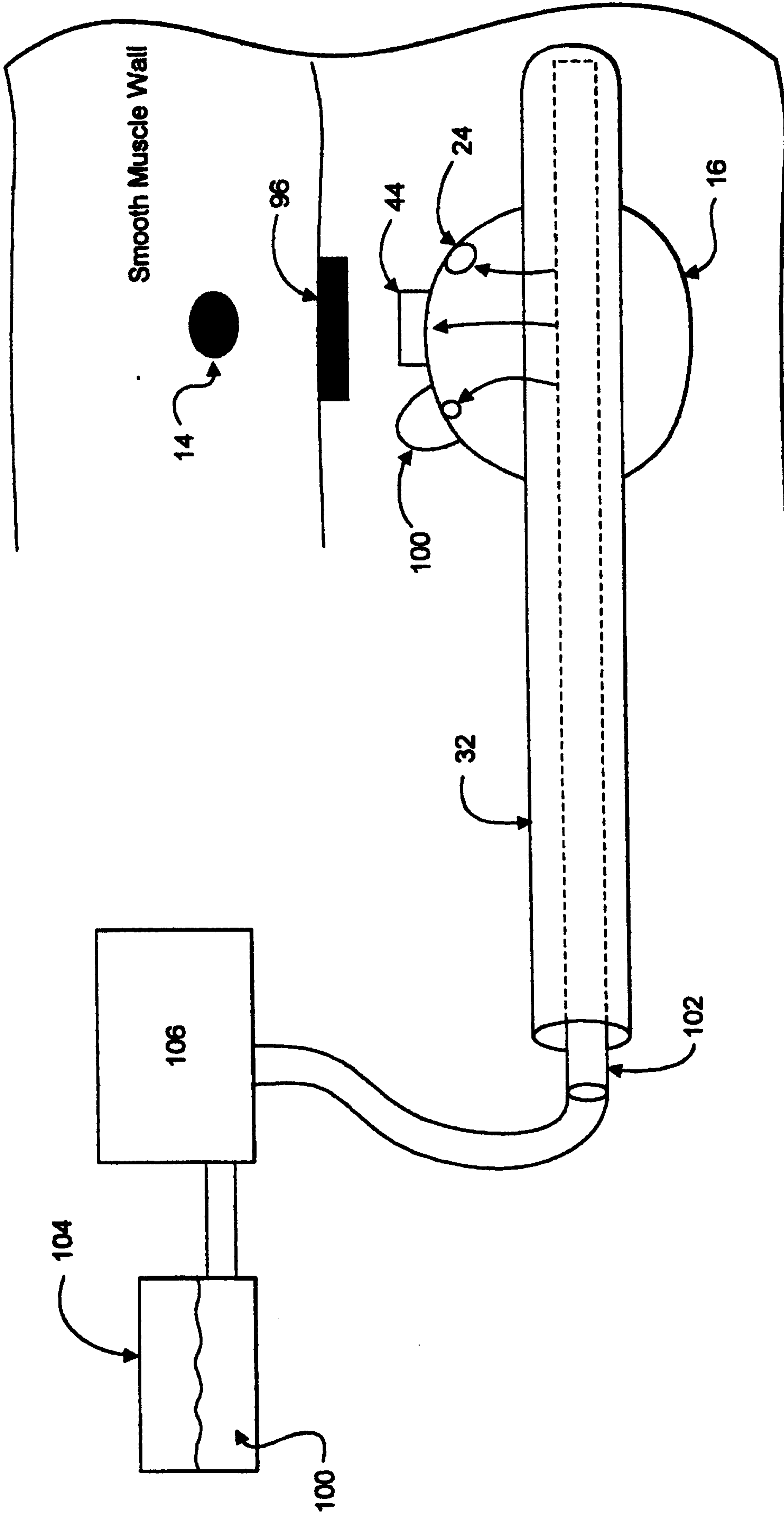

FIG. 25

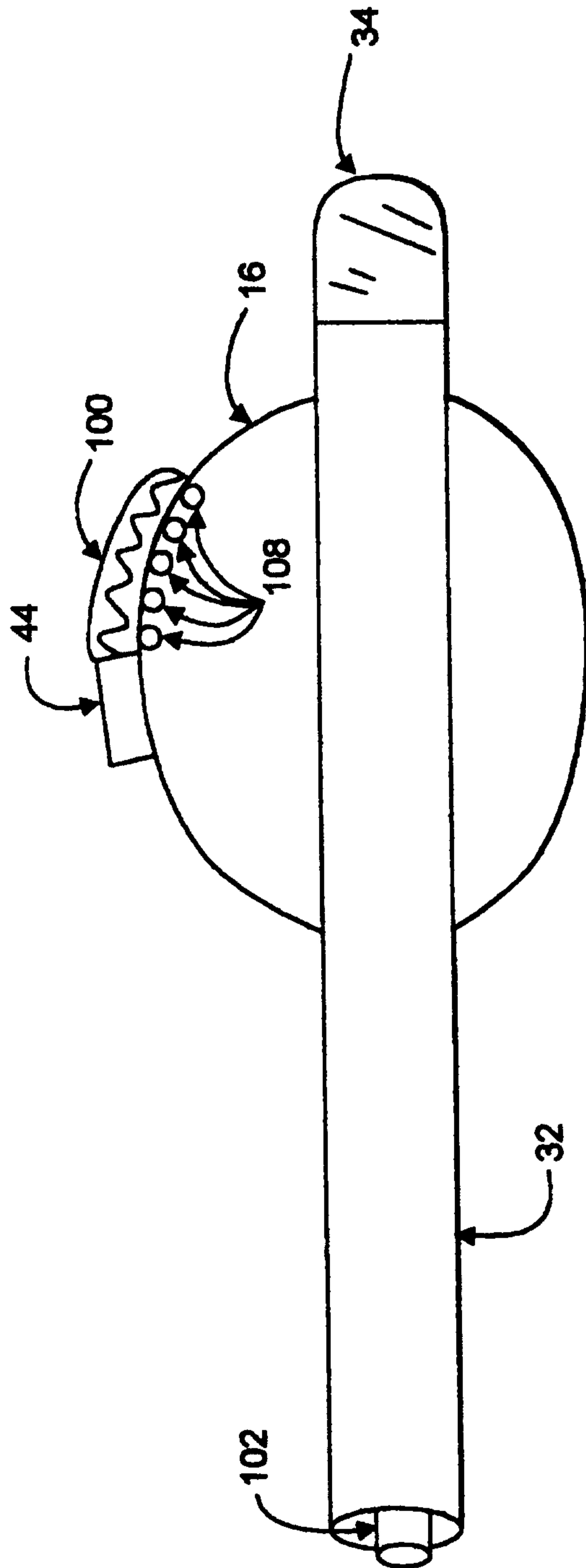

FIG. 26

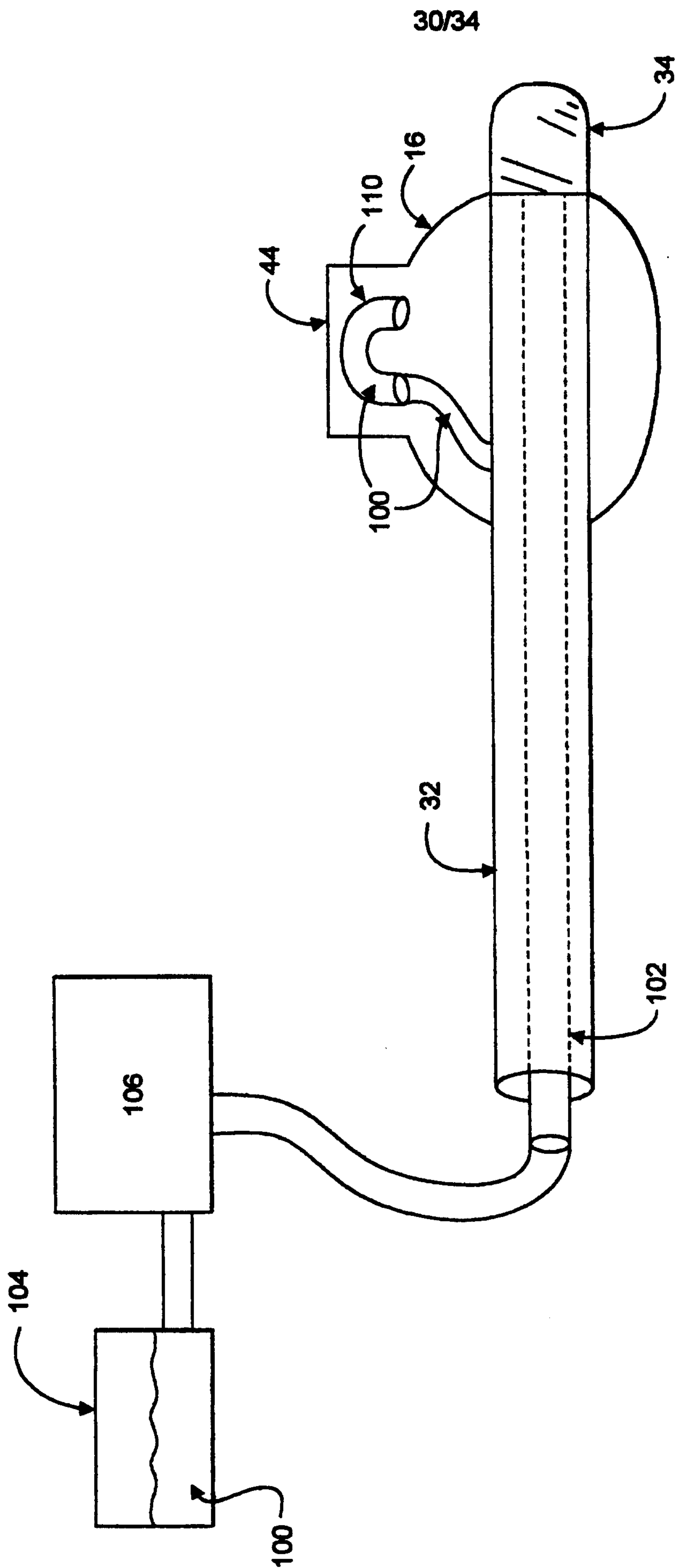

FIG. 27

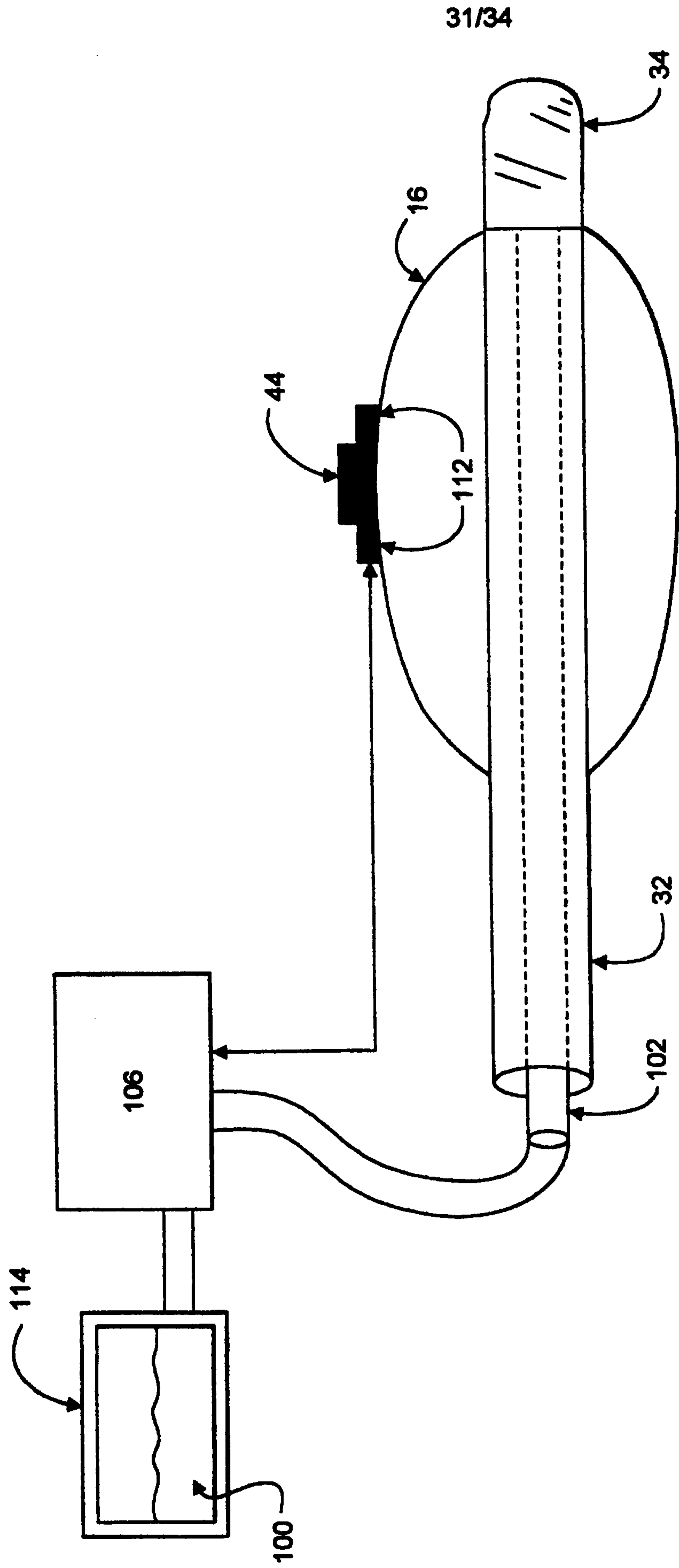

FIG. 28

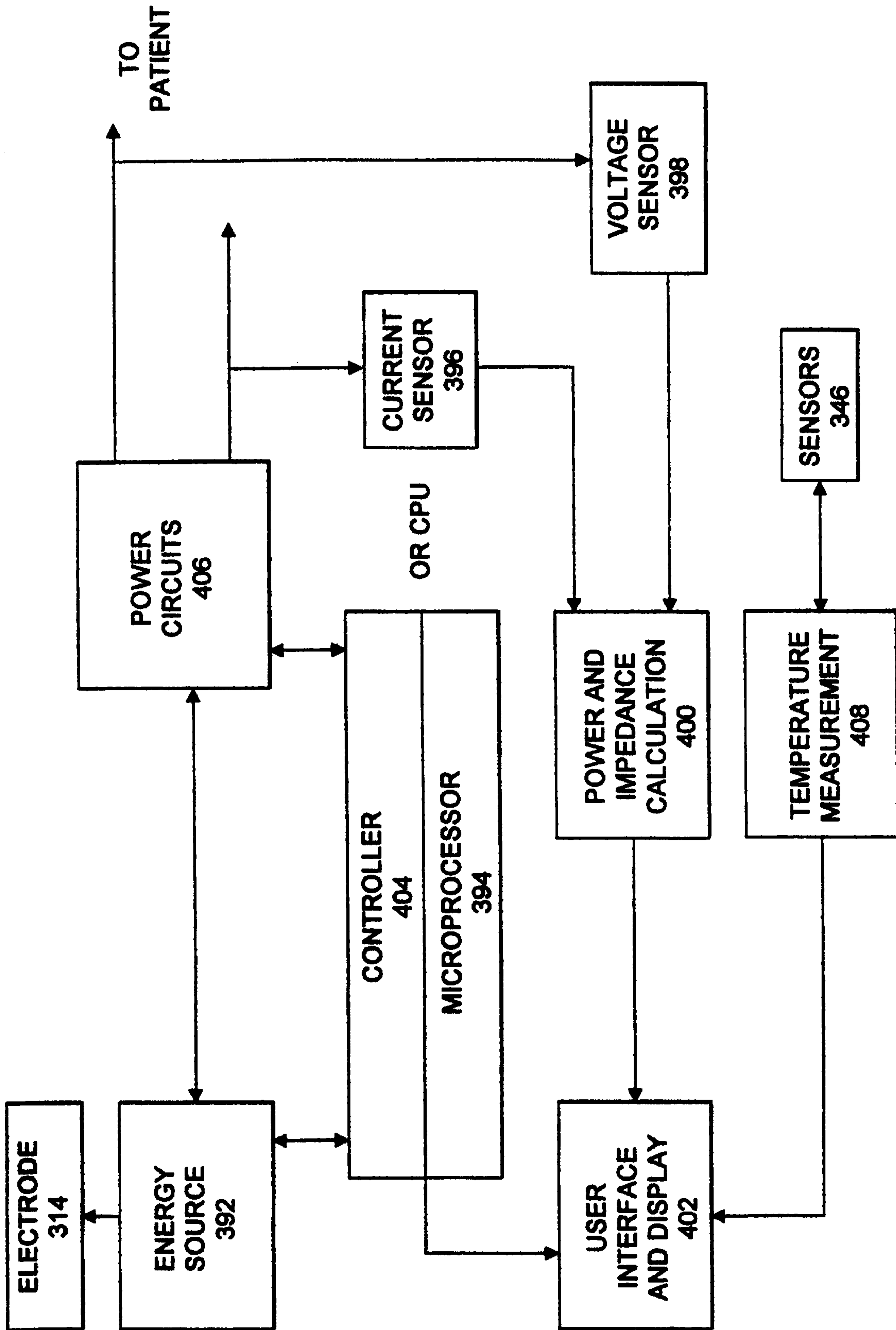

FIG. 29

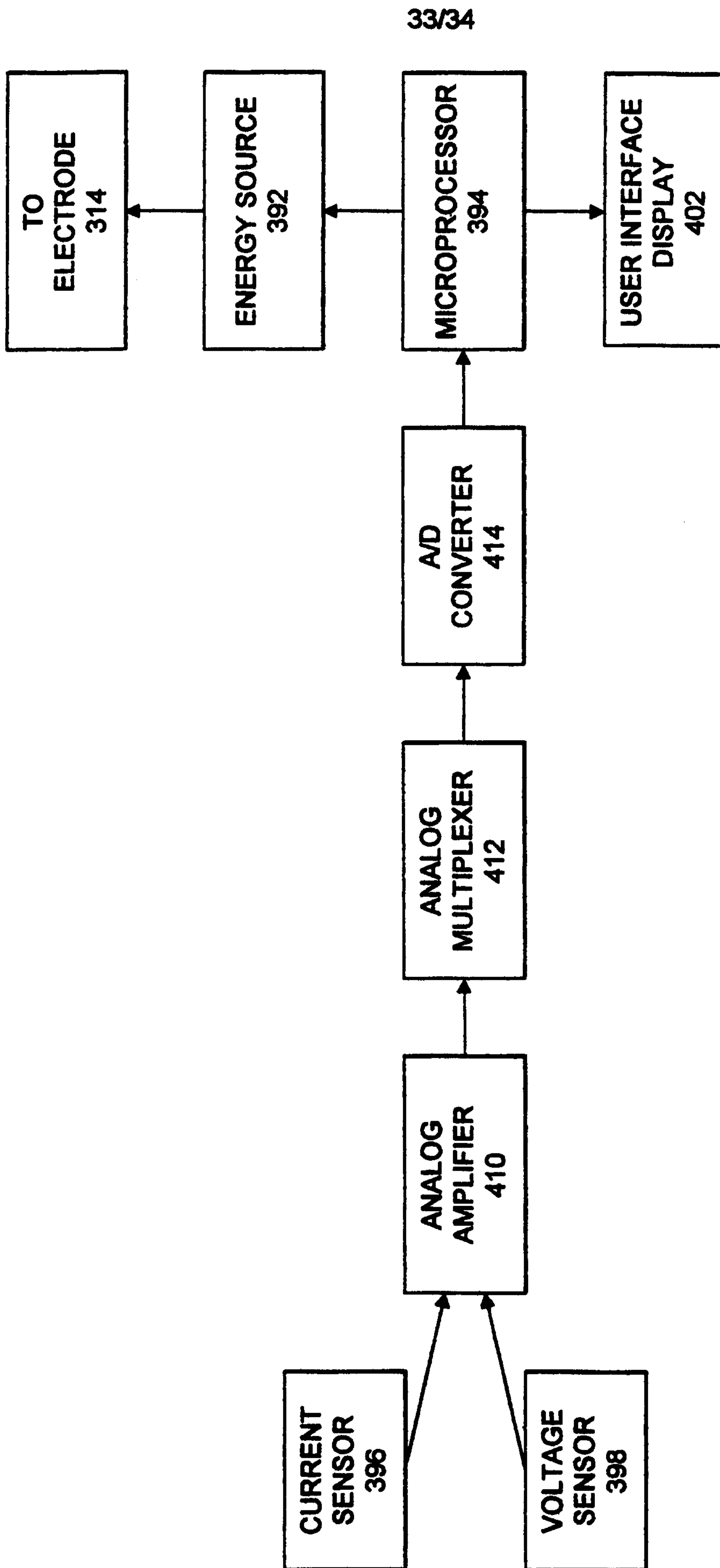

FIG. 30

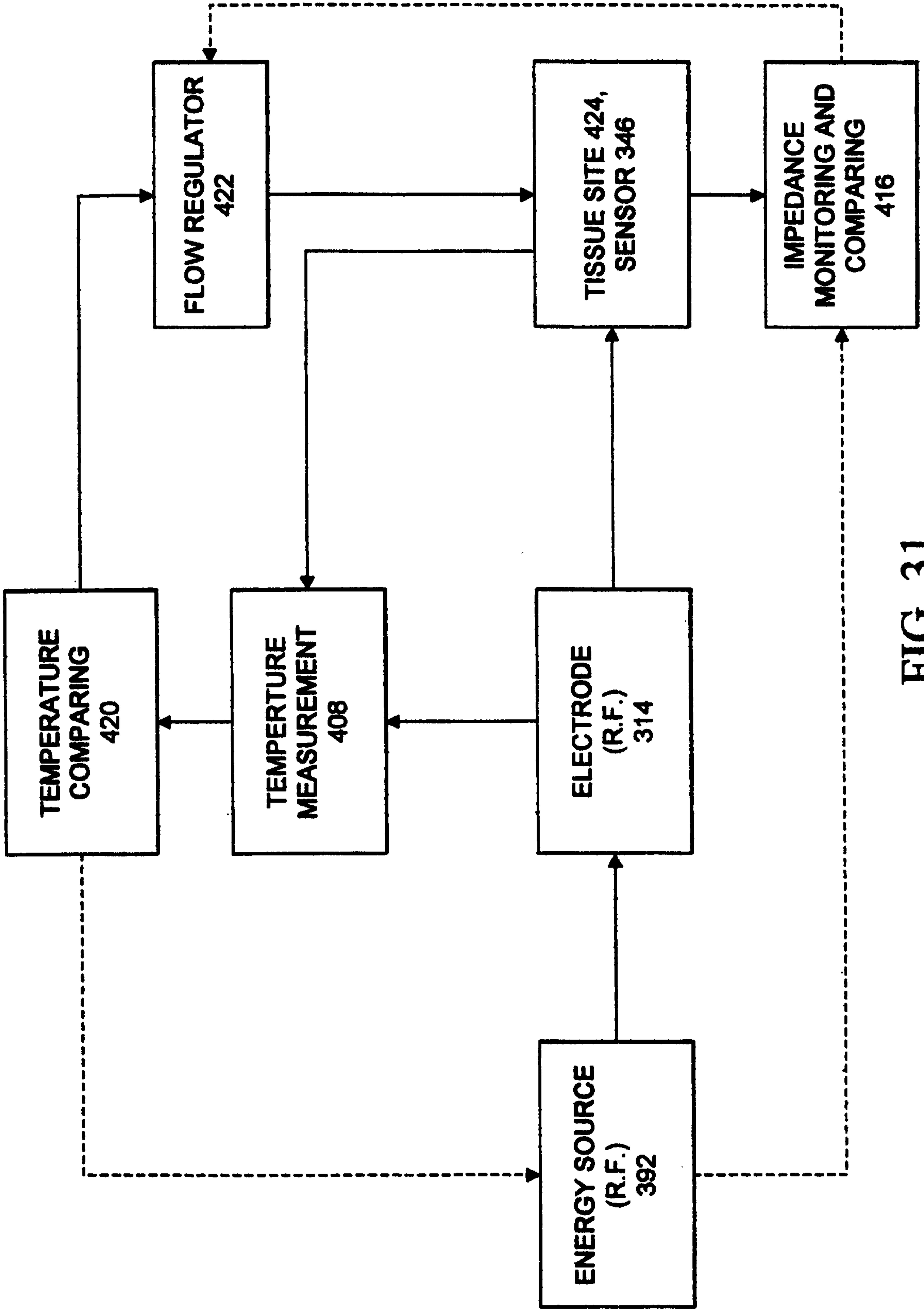

FIG. 31

