

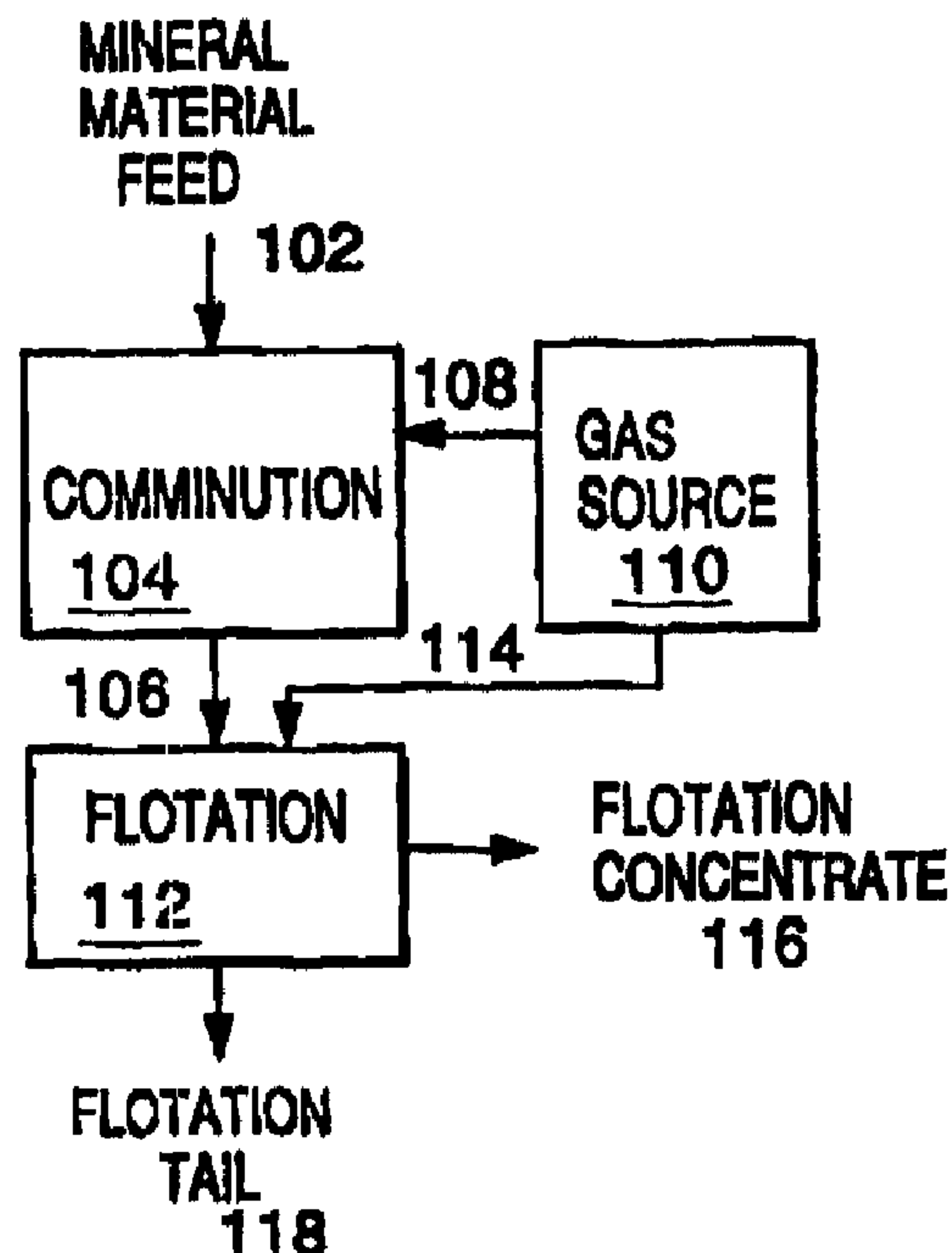

(86) Date de dépôt PCT/PCT Filing Date: 1997/10/23
 (87) Date publication PCT/PCT Publication Date: 1998/04/30
 (45) Date de délivrance/Issue Date: 2002/08/13
 (85) Entrée phase nationale/National Entry: 1999/03/02
 (86) N° demande PCT/PCT Application No.: US 1997/018958
 (87) N° publication PCT/PCT Publication No.: 1998/017395
 (30) Priorité/Priority: 1996/10/23 (08/735,783) US

(51) Cl.Int.⁶/Int.Cl.⁶ B03D 1/00, B03C 1/30, B03D 1/02
 (72) Inventeurs/Inventors:
 GATHJE, John C., US;
 SIMMONS, Gary L., US
 (73) Propriétaire/Owner:
 NEWMONT GOLD COMPANY, US
 (74) Agent: JOHNSON, ERNEST PETER

(54) Titre : PROCEDE DE TRAITEMENT DE MINERAIS SULFURES AURIFERES REFRACTAIRES COMPRENANT LA PREPARATION D'UN CONCENTRE SULFURE
 (54) Title: A METHOD FOR PROCESSING REFRACTORY AURIFEROUS SULFIDE ORES INVOLVING PREPARATION OF A SULFIDE CONCENTRATE



(57) **Abrégé/Abstract:**

A method is disclosed for processing a gold-bearing refractory sulfide ore (102) by maintaining the ore in a substantially oxygen free environment, preferably beginning with comminution (104) of the ore and ending after a desired final concentrate, enriched in sulfide minerals, is obtained by flotation (112). In one embodiment, nitrogen gas (110) is used to prevent contact between the ore and air during comminution of the ore (108) and during flotation operations (114). This invention recognizes that gold in refractory sulfide ores primarily occurs in refractory auriferous sulfides, which are typically the most difficult sulfide species in the ores to float. By reducing the exposure of those refractory auriferous sulfides to oxygen gas during flotation, flotation recovery is enhanced in the form of a flotation concentrate (116). A flotation tail (118) is also obtained from the process.



PCT

WORLD INTELLECTUAL PROPERTY ORGANIZATION
International Bureau

INTERNATIONAL APPLICATION PUBLISHED UNDER THE PATENT COOPERATION TREATY (PCT)

(51) International Patent Classification ⁶ : B03D 1/00, 1/14, B01D 11/00, B03C 1/30	A1	(11) International Publication Number: WO 98/17395 (43) International Publication Date: 30 April 1998 (30.04.98)
<p>(21) International Application Number: PCT/US97/18958</p> <p>(22) International Filing Date: 23 October 1997 (23.10.97)</p> <p>(30) Priority Data: 08/735,783 23 October 1996 (23.10.96) US</p> <p>(71) Applicant (for all designated States except US): SANTA FE PACIFIC GOLD CORPORATION [US/US]; Suite 2800, 1700 Lincoln Street, Denver, CO 80203 (US).</p> <p>(72) Inventors; and (75) Inventors/Applicants (for US only): SIMMONS, Gary, L. [US/US]; 1360 Canyon Drive, Castle Rock, CO 80104 (US). GATHJE, John, C. [-/US]; 1231 Princeton, Longmont, CO 80503 (US).</p> <p>(74) Agents: BREYFOGLE, Ross, E. et al.; Holme Roberts & Owen LLP, Suite 4100, 1700 Lincoln Street, Denver, CO 80203-4541 (US).</p>	<p>(81) Designated States: AL, AM, AT, AU, AZ, BA, BB, BG, BR, BY, CA, CH, CN, CU, CZ, DE, DK, EE, ES, FI, GB, GE, GH, HU, ID, IL, IS, JP, KE, KG, KP, KR, KZ, LC, LK, LR, LS, LT, LU, LV, MD, MG, MK, MN, MW, MX, NO, NZ, PL, PT, RO, RU, SD, SE, SG, SI, SK, SL, TJ, TM, TR, TT, UA, UG, US, UZ, VN, YU, ZW, ARIPO patent (GH, KE, LS, MW, SD, SZ, UG, ZW), Eurasian patent (AM, AZ, BY, KG, KZ, MD, RU, TJ, TM), European patent (AT, BE, CH, DE, DK, ES, FI, FR, GB, GR, IE, IT, LU, MC, NL, PT, SE), OAPI patent (BF, BJ, CF, CG, CI, CM, GA, GN, ML, MR, NE, SN, TD, TG).</p> <p>Published With international search report.</p>	

(54) Title: A METHOD FOR PROCESSING REFRACTORY AURIFEROUS SULFIDE ORES INVOLVING PREPARATION OF A SULFIDE CONCENTRATE

(57) Abstract

A method is disclosed for processing a gold-bearing refractory sulfide ore (102) by maintaining the ore in a substantially oxygen free environment, preferably beginning with comminution (104) of the ore and ending after a desired final concentrate, enriched in sulfide minerals, is obtained by flotation (112). In one embodiment, nitrogen gas (110) is used to prevent contact between the ore and air during comminution of the ore (108) and during flotation operations (114). This invention recognizes that gold in refractory sulfide ores primarily occurs in refractory auriferous sulfides, which are typically the most difficult sulfide species in the ores to float. By reducing the exposure of those refractory auriferous sulfides to oxygen gas during flotation, flotation recovery is enhanced in the form of a flotation concentrate (116). A flotation tail (118) is also obtained from the process.

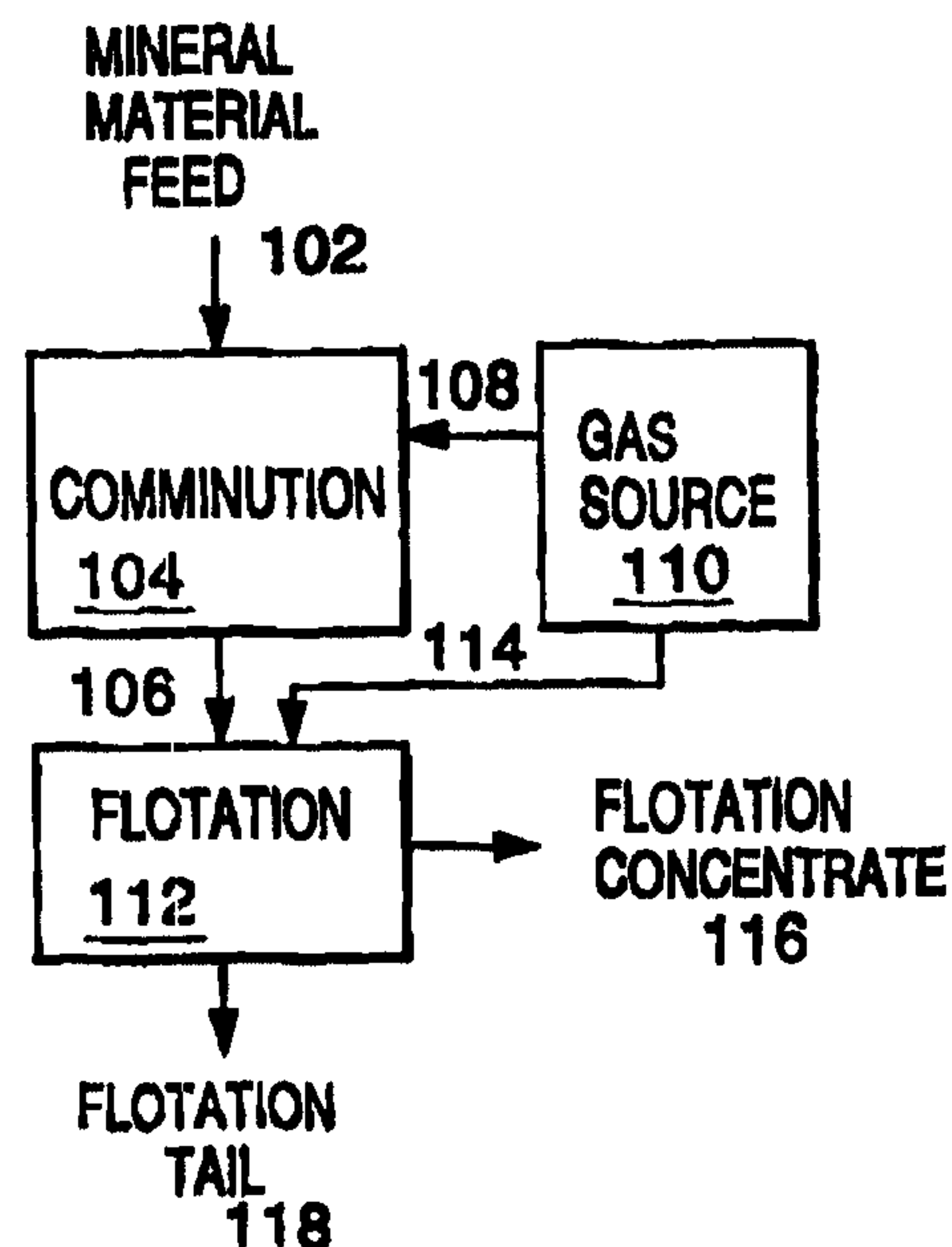

A METHOD FOR PROCESSING REFRACTORY AURIFEROUS SULFIDE
ORES INVOLVING PREPARATION OF A SULFIDE CONCENTRATE

5

FIELD OF THE INVENTION

The present invention involves a method for processing gold-bearing refractory sulfide ores, including refractory auriferous sulfides, to facilitate recovery of gold. In particular, the present invention involves flotation processing of refractory sulfide ores in a manner that reduces problems associated with conventional flotation of refractory auriferous sulfides in the ore to produce an ore concentrate that is concentrated in the refractory auriferous sulfides and, accordingly, also in the gold within the refractory auriferous sulfides.

10

BACKGROUND OF THE INVENTION

15

Significant amounts of gold occur in ores that are often referred to as refractory sulfides. The gold in these ores is often referred to as being refractory because it cannot be recovered by direct cyanidation. That is because the refractory gold is bound in the mineral lattice of the sulfides, and is therefore unavailable for recovery by traditional gold recovery techniques, such as direct cyanidation of the ore. Therefore, these refractory sulfide ores are commonly treated to chemically destroy the sulfide mineral lattice in which the gold is located and to release the gold for dissolution, such as by cyanidation, during subsequent gold recovery operations.

20

One technique for destroying the sulfide mineral lattice is to subject the ore to an oxidative treatment to oxidize sulfide sulfur, thereby releasing the gold for subsequent recovery. One method for oxidatively treating a refractory sulfide ore is pressure oxidation, in which a slurry of the ore is subjected to oxygen gas in an autoclave at elevated temperature and pressure to decompose the sulfide mineral, freeing the gold for subsequent recovery. Other oxidative treating methods include roasting and bio-oxidation of the ore in the presence of air or oxygen gas.

25

30

Treating whole ores by pressure oxidation or by oxidative roasting is expensive. Part of the expense is due to energy consumed in heating gold-barren gangue material in the whole ore, and especially the energy required to heat water in which the gangue material is slurried in the case of pressure oxidation. Also, process equipment for treating

a whole ore must be sized to accommodate the throughput of gangue material, in addition to the throughput of refractory auriferous sulfides, thereby significantly adding to the cost of process equipment. Moreover, side reactions may occur involving gangue material which can detrimentally affect the oxidative treating or can produce hazardous materials
5 which require special handling.

One way to reduce the high energy and process equipment costs associated with oxidative treating of a whole ore, as well as the potential for problems associated with side reactions, would be to remove gangue material from the ore prior to the oxidative treatment. For example, one method that has been used to remove gangue material from
10 refractory sulfide ores is flotation. In flotation, air is bubbled through a slurry of ore particles which have been treated with reagents and the particles of the ore which are less hydrophilic tend to attach to and rise with the air bubbles, thereby permitting separation of the ore into two fractions. Flotation has been used to prepare concentrates of sulfide minerals from refractory sulfide ores in an attempt to concentrate the gold into the
15 flotation concentrate, thereby avoiding the expense of processing the gangue in subsequent oxidative treating. One problem with flotation of refractory sulfide ores, however, is that a significant amount of refractory gold often reports to the wrong flotation fraction, even when a high percentage of sulfide minerals is recovered in the concentrate.

20 There is a significant need for an improved method for processing refractory sulfide ores that avoids the high costs associated with oxidatively treating whole ores without the significant loss of refractory gold associated with concentrating sulfide minerals by conventional flotation.

25 SUMMARY OF THE INVENTION

The present invention involves a method for processing refractory sulfide ores to facilitate gold recovery without the burden of pressure oxidizing or roasting a whole ore and without the substantial loss of gold value associated with preparation of an ore concentrate by conventional flotation. With the present invention, it has been found that
30 much of the refractory gold in refractory sulfide ores is contained in sulfide species referred to herein as refractory auriferous sulfides. Although these sulfide species may

represent only a small fraction of the sulfides in a refractory sulfide ore, they typically contain a majority of the refractory gold.

As used herein, refractory auriferous sulfides are sulfides containing gold that is not amenable to direct cyanidation except by destruction of the sulfide mineral lattice, which is usually accomplished by oxidation of the refractory auriferous sulfide. Typically, these refractory auriferous sulfides are auriferous arseno ferrous sulfides, having a composition according to the formula $Fe_xAs_yS_z \cdot Au$, with x,y and z being in any relative proportions. The gold contained in the refractory auriferous sulfides is in solid solution in the sulfide mineral lattice and is refractory gold in that it is not amenable to recovery by direct cyanidation except by destruction of the sulfide mineral lattice, which is typically accomplished by oxidation of the refractory auriferous sulfides. Such solid solution gold is also sometimes referred to as atomic gold or structural gold.

It has been found that the largest occurrences of refractory gold in refractory sulfide ores occur in these refractory auriferous sulfides. Little, if any, refractory gold occurs in other, more classically recognized pure iron-sulfur containing sulfide species, such as pyrite (FeS_2), marcasite (FeS_2), and pyrrhotite ($Fe_{(1-x)}S$, with x ranging from 0 to 0.17).

This distinction is important because traditional flotation, involving the use of air as a flotation gas, is often effective for recovering a large fraction of the more traditionally recognized iron-containing sulfide species. It has been found with the present invention, however, that the traditional flotation is not effective for flotation of refractory auriferous sulfides, which contain most of the refractory gold. Therefore, it is often possible with traditional flotation to recover a high percentage of sulfide minerals in the concentrate, and at the same time experience a low recovery in the concentrate of refractory gold. This is because an unacceptably large fraction of the refractory auriferous sulfides, which contain most of the refractory gold, reports to the flotation tails.

The refractory auriferous sulfides should not be confused with non-refractory sulfides. Gold in non-refractory sulfides occurs as particulate gold that is amenable to direct cyanidation without destruction of the sulfide mineral lattice. This non-refractory, particulate gold may be exposed, to the extent necessary, for direct cyanidation by mechanical processing, such as comminution to a very fine particle size, prior to direct

cyanidation. It should be noted, however, that although gold from non-refractory sulfides may be recovered by direct cyanidation, it is not always economic to do so. For example, particulate gold inclusions are often found in copper and other base metal sulfides. The copper in many copper sulfides, however, has varying degrees of solubility by direct cyanidation. Therefore, cyanide consumption becomes prohibitively large for economic gold extraction by direct cyanidation because of the concurrent cyanide dissolution of the copper.

It has been found with the present invention that air, which is used as the flotation gas in conventional flotation, detrimentally affects flotation of refractory auriferous sulfides. According to the present invention, significantly enhanced flotation performance may be obtained by maintaining the ore in an environment substantially free of air until a desired final flotation concentrate has been obtained.

It is believed that refractory auriferous sulfides are particularly reactive and susceptible to surface oxidation when in the presence of oxygen gas, such as is present in air. It is this reactivity that can cause a significant fraction of the refractory auriferous sulfides to be depressed during conventional flotation in air.

By using a flotation gas that is deficient in oxygen gas relative to air, however, the problems associated with the use of air can be reduced. This results in an increased recovery of refractory auriferous sulfides in the concentrate, and correspondingly, an increase in the recovery of refractory gold in the concentrate. It is also believed that the presence of oxygen promotes increased galvanic interaction, which tends to depress the refractory auriferous sulfides during flotation.

In one embodiment, the refractory auriferous sulfides in a refractory sulfide ore are maintained in an environment that is substantially free of oxygen beginning with comminution of the ore and ending with recovery of a desired final concentrate that is enriched in the refractory auriferous sulfides. An oxygen deficient gas can be introduced prior to or during comminution to displace any air that may be present in the ore feed and to prevent air from entering during comminution. Oxygen in the air that would otherwise be present during comminution is, thereby, prevented from oxidizing newly exposed surfaces of refractory auriferous sulfides created during comminution. Although comminution in an atmosphere of the oxygen deficient gas is preferred, an alternative to reduce detrimental effects of oxygen is to seal the entire comminution process to prevent

air from entering into the process during comminution. With this alternative, only oxygen initially in the feed to comminution will be present, so that damage to refractory auriferous sulfides will be limited.

5 In addition to reducing the levels of oxygen during comminution and flotation, the use of an oxygen deficient gas tends to decrease galvanic interaction, with a corresponding increase in floatability of refractory auriferous sulfides. In one embodiment, galvanic interaction is further reduced by reducing the amount of iron introduced into the system and/or by removing iron from the system. Iron contamination in the system may be reduced by using comminution media made of stainless steel or a
10 chromium or nickel hardened steel, rather than the normal mild steel, and/or by using a nonmetallic liner for comminution equipment. Iron may be removed from the system prior to flotation by magnetic separation. It has been found that reducing galvanic interaction can significantly improve recovery of refractory auriferous sulfides during flotation, especially when flotation is conducted with an oxygen deficient flotation gas.

15 Possible sources of the oxygen deficient gas include by-product gas from an oxygen plant, a dedicated nitrogen plant, combustion exhaust gases, and on-site delivery of compressed or liquefied gases. In one embodiment to reduce the consumption of the oxygen deficient gas, flotation gas is recycled in the flotation operation.

When using an oxygen-deficient flotation gas according to the present invention,
20 adjustment of other flotation operating parameters have been found to be unusually important to maximizing flotation performance. In that regard, it has been found that the flotation should be operated at an acidic pH, preferably below about pH 6. Also, use of a lead-containing activator significantly enhances flotation performance, as does the use of deoxygenated water during comminution and flotation. These additional
25 enhancements are particularly important because, as noted, it has been found that the refractory gold is often most associated with the refractory auriferous sulfides, which are the mineralogical/morphological sulfide species that are generally the hardest to float. Therefore, for example, a flotation enhancement that increases sulfide mineral recovery by just one percentage point may increase recovery of refractory gold in the concentrate
30 by a proportionately larger amount. This is because the incremental sulfide mineral particles that tend to float with each enhancement include those most likely to contain

significant quantities of refractory gold. Conversely, the sulfide minerals that are easiest to float, such as pyrite, often contain little or no gold.

Another embodiment according to the present invention includes a leach of flotation tails to recover non-refractory gold that may remain in the flotation tail. Many ores contain both refractory and non-refractory gold. Most of the non-refractory gold, if contained in non-refractory sulfides, will float during flotation along with the refractory auriferous sulfides. Other non-refractory gold, such as that associated with oxidized mineral species, may report to the flotation tail, from which this non-refractory gold may be recovered by cyanidation of the flotation tail. For some sulfide ores, the non-refractory gold in the flotation tail may be a significant quantity of gold. A major advantage of the present invention is that the flotation tail is relatively clean of sulfide minerals. This is important to effective cyanide leaching of the tail because of the significant loss of cyanide that would occur if significant quantities of sulfide minerals were present in the flotation tails.

In a still further embodiment according to the present invention, a significant operational enhancement is obtained by performing a regrind operation intermediate between two flotation stages or on a sand fraction from the first flotation tail, after size separation to remove fines from the sands. This permits a more coarse initial grind to be used for an initial stage of flotation to recover a significant quantity of sulfide species in the ore, including a significant quantity of the refractory auriferous sulfides. The regrind permits additional liberation of sulfide species locked in middling particles. A very fine grind may be required in this regrind to effectively liberate refractory auriferous sulfides that may be locked in middlings, because the refractory auriferous sulfides tend to be fine grained in character. Such staged processing would not be possible with conventional air flotation because of the detrimental effects of oxygen on refractory auriferous sulfides during conventional grinding and flotation.

In one embodiment of the present invention, the flotation operation that is conducted substantially in the absence of oxygen gas, is combined with oxidative treating to decompose the refractory auriferous sulfides, freeing refractory gold for possible subsequent dissolution using a gold lixiviant, such as a cyanide. The preferred oxidative treating is pressure oxidation, although another oxidative treatment such as an oxidizing roast or bio-oxidation may be used instead. Such oxidative treating often requires a

source of purified oxygen gas, which is often produced by separation from air in an oxygen plant. A by-product gas from such an oxygen plant is deficient in oxygen gas and rich in nitrogen gas. The by-product gas is, therefore, an ideal source of gas for use during comminution and/or flotation of an ore including refractory auriferous sulfides.

5 This by-product gas is normally vented to the atmosphere in current gold processing operations and is, therefore, wasted.

BRIEF DESCRIPTION OF THE DRAWINGS

- Fig. 1 is a flow diagram showing one embodiment of the present invention;
- 10 Fig. 2 is a flow diagram showing another embodiment of the present invention;
- Fig. 3 is a flow diagram showing yet another embodiment of the present invention;
- Fig. 4 is a graph of the grade of concentrate recovered from flotation versus grind size Examples 1-6;
- 15 Fig. 5 is a graph of the grade of tails from flotation versus grind size Examples 1-6;
- Fig. 6 is a graph of concentrate weight percent recovery from flotation versus grind size for Examples 1-6;
- Fig. 7 is a graph of gold recovered in concentrate from flotation versus grind size
- 20 for Examples 1-6;
- Fig. 8 is a flow diagram for one embodiment of the present invention relating to a pilot plant for Example 7; and
- Fig. 9 is a graph of gold recovery in concentrate from flotation versus grind size for Example 8;
- 25 Fig. 10 is a flow diagram of one embodiment of the present invention including acid pretreatment;
- Fig. 11 is a process flow diagram of one embodiment of the present invention showing recycle of flotation gas;
- Fig. 12 is a sectional elevation showing features of one embodiment of a flotation
- 30 apparatus of the present invention;
- Fig. 13 is a sectional elevation of another embodiment of a flotation apparatus of the present invention;

Fig. 14 is a process flow diagram of a comminution circuit of one embodiment of the present invention;

Fig. 15 is a process flow diagram of one embodiment of the present invention including magnetic separation prior to flotation;

5 Fig. 16 is a process diagram of one embodiment of the present invention including a leach of flotation tails and including the use of deoxygenated water;

Fig. 17 is a process flow diagram of one method of the present invention having multiple flotation stages with comminution occurring between flotation stages;

10 Fig. 18 is a graph with plots of sulfide sulfur recovery versus pH for Examples 9-28;

Fig. 19 is a graph including plots of gold recovery versus pH for Examples 9-28;

Fig. 20 is a graph including plots of incremental gold recovery and incremental sulfide sulfur recovery for Examples 9-28;

15 Fig. 21 is a graph including plots of gold recovery versus flotation time for Examples 29-35;

Fig. 22 is a graph of gold recovery versus flotation time for Examples 29-35;

Fig. 23 is a graph including plots of gold recovery and oxidation-reduction potential versus flotation time for Example 36;

20 Fig. 24 is a graph including plots of gold recovery and oxidation-reduction potential versus flotation time for Example 37;

Fig. 25 is a graph including plots of weight recovery versus flotation time for Example 38;

Fig. 26 is a graph including plots of gold-recovery versus flotation time for Example 38;

25 Fig. 27 is a graph including plots of sulfide sulfur recovery versus flotation time for Example 38;

Fig. 28 is a process flow diagram of one embodiment of the present invention using gas generated in an acid pretreatment step as a flotation gas.

30 DETAILED DESCRIPTION OF THE PREFERRED EMBODIMENT

The present invention provides a method for processing a mineral material including refractory auriferous sulfides to facilitate recovery of the gold from the

refractory auriferous sulfides. The method involves preparation of a flotation concentrate in a manner that reduces problems associated with conventional flotation. It has, surprisingly, been found that the problems associated with concentrating refractory auriferous sulfides by conventional flotation may be significantly reduced by the use of
5 a flotation gas which comprises a lower volume fraction of oxygen gas than is present in ambient air. Preferably, the flotation gas should be substantially free of oxygen gas. When air is used as a flotation gas, the oxygen gas in the air appears to detrimentally affect the floatability of the refractory auriferous sulfides. This may be due to surface oxidation of refractory auriferous sulfides caused by the presence of the oxygen gas. The
10 surface oxidation would tend to depress the refractory auriferous sulfides during flotation. Furthermore, the detrimental effects of oxygen gas may be further reduced by maintaining the ore in an environment that is substantially free of oxygen gas during comminution, mixing, pumping and all other processing steps until a final flotation concentrate has been obtained. For example, when multiple flotation steps are used, it is desirable to maintain
15 the ore in an environment that is substantially free of oxygen gas between the flotation steps.

By reducing the apparently detrimental effects of oxygen gas, it is possible to recover a greater amount of the sulfide mineral species, including refractory auriferous sulfides, in the flotation concentrate. The present invention, therefore, facilitates the
20 recovery of gold from sulfide mineral material which may have previously been discarded as waste, either with the gangue in a flotation tail or as subgrade ore previously believed to be uneconomical for gold recovery.

Enhanced concentration, according to the present invention, of sulfide minerals into the flotation concentrate provides a particular advantage with respect to gold
25 recovery from refractory auriferous sulfides. This is because it has been found that refractory gold in a refractory sulfide ore is often predominantly associated with refractory auriferous sulfides, the sulfide mineral mineralogical/morphological species that are most difficult to effectively float. Therefore, the increase in gold recovery in the concentrate with the present invention will often be a substantially greater percentage
30 increase than the percentage increase in recovery of sulfide minerals.

One important class of refractory auriferous sulfides are arsenian iron sulfides, including arsenian pyrite, arsenian marcasite and arsenian pyrrhotite. These refractory

auriferous sulfides are different in composition from pyrite, marcasite and pyrrhotite, respectively, in that they include arsenic in the mineral lattice in a manner that also permits the inclusion of gold in the mineral lattice in the form of a solid solution. Inclusion of the arsenic provides some amount of irregularity in the mineral lattice
5 relative to the pure iron-sulfide minerals pyrite. The irregularity provides space within the sulfide mineral lattice to accommodate the presence of gold atoms in the sulfide mineral lattice in the form of a solid solution. This irregularity also increases the susceptibility of the refractory auriferous sulfides to oxidation in the presence of air and to galvanic interaction, both of which are detrimental to flotation. The arsenic content
10 in these arsenian iron sulfides is often in a range of from about 0.01 weight percent to about 10.0 weight percent. These arsenian iron sulfides may have a lattice structure that varies from anhedral to euhedral. Typically, the arsenian iron sulfides have a grain size and/or morphology that is fine grained, amorphous, framboidal, microcrystalline, blastic or rimmed.

15 Not all refractory auriferous sulfides are, however, arsenian iron sulfides. For example, arsenic-rich sulfide species, such as those based on orpiment (As_2S_3) and realgar (As_4S_4), may include small quantities of iron in the mineral lattice that provide sufficient irregularity to permit the inclusion within the mineral lattice of gold in the form of a solid solution. Furthermore, arsenopyrite (FeAsS) may contain gold in its mineral lattice
20 in a solid solution, and may be a refractory auriferous sulfide.

The arsenic-containing, iron-rich, refractory auriferous sulfides (i.e., arsenian iron sulfides) and the iron-containing, arsenic-rich refractory auriferous sulfides are not classically recognized sulfide species because, strictly speaking, they do not have the classic composition of pyrite, marcasite, pyrrhotite, orpiment or realgar, as the case may
25 be. Most of the refractory auriferous sulfides fall into the category of chemical/structural variances from classical sulfide species that have not been systematically characterized based upon their arsenic, iron and gold contents and their respective floatabilities. A few classically recognized pure sulfide minerals, however, may include some quantities of gold in the mineral lattice and may, therefore, also be refractory auriferous sulfides.
30 These include arsenopyrite and variations thereof, which appear to include some room within their mineral lattices to accept meaningful quantities of gold in a solid solution form.

As an example of concentration of gold in difficult-to-float mineralogical/morphological species, a detailed mineralogical characterization is shown in Table 1 of sulfide species found in two refractory sulfide ore samples. One ore sample is from the Lone Tree Mine and the other ore sample is from the Twin Creeks Mine, both in Nevada, U.S.A. As shown in Table 1, the arsenian pyrite species represent a variety of mineralogical/morphological types. A common theme, however, is that the gold content generally tends to increase as the grain size and/or morphologic character becomes finer. Coarse grained pyrite typically contains insignificant levels of gold, whereas fine grained, amorphous and framboidal arsenian pyrite species all contain much higher levels of gold. The arsenian pyrite species shown in Table 1 are arranged in decreasing coarseness of grain size except for orpiment, marcasite and arsenopyrite. It is these arsenian pyrites having finer grain size and/or morphological character that are particularly benefitted by the flotation of the present invention. Also, as shown in Table 1, arsenian marcasite and iron-containing orpiment also include significant quantities of refractory gold.

Table 1 shows the arsenian pyrite refractory auriferous sulfide species including morphologies of coarse grained, blastic, medium grained, fine grained/framboidal, amorphous/framboidal, and framboidal. As seen in Table 1, these arsenian pyrite refractory auriferous sulfides (blastic, medium grained, fine grained/framboidal, amorphous/framboidal, and framboidal) have a much higher gold content than the coarse grained pure pyrite, which is substantially free of arsenic, which has an uninterrupted pyrite mineral lattice that does not contain sufficient space for including gold atoms within the mineral lattice.

Unlike coarse grained pure pyrite, the arsenian iron sulfide refractory auriferous sulfides all include sufficient quantities of arsenic to interrupt the mineral lattice of the species and permit gold atoms to be included within the mineral lattice in a solid solution form.

Table 1

Sulfide Morphology	Lone Tree		Twin Creeks		Grain Size
	Au (ppm)	As (%)	Au (ppm)	As (%)	
Coarse Grained Pyrite	0.35	0.18	0.41	<0.001	Coarse
5 Coarse Grained Arsenian Pyrite	4	2.05	3.1	0.12	Coarse
Blastic Arsenian Pyrite	25	0.26	NA ¹	NA ¹	Coarse
Medium Grained Arsenian Pyrite	48	2.7	9	NI ³	Medium
10 Fine Grained/Framboidal Arsenian Pyrite	103	6.5	58 29 ⁴	NI ³ 1.45 ⁴	Fine
Amorphous/Framboidal Arsenian Pyrite	NA ¹	NA ¹	96 187 ⁴	NI ³ 1.41 ⁴	Fine to very fine
15 Framboidal Arsenian Pyrite	190 ²	5.5	271	NI ³	Very fine
Arsenian Marcasite	34	1.6	16 1.2 ⁴	NI ³ 0.1 ⁴	NA ¹
Iron-Containing Orpiment	NA ¹	NA ¹	55	7.64 ⁵	NA ¹
Arsenopyrite	20.5	NI ³			

20

¹ Not applicable.² Average content from 5 high grade samples from fine grained/amorphous material.³ NI = No Arsenic information reported.⁴ Second sampling.⁵ Fe%.

25

30

35

Finer grain size and finer morphological character of a sulfide mineral renders the sulfide mineral generally more susceptible to the detrimental effects from the presence of oxygen in a flotation system. To obtain a high recovery of gold in a flotation concentrate it is, therefore, extremely important that the flotation be operated in a manner to maximize the flotation of those mineralogical morphologies that are most difficult to float. To illustrate this problem, calculated gold losses are shown in Table 2 in flotation tailings for each one percent equivalent loss of sulfide mineral to the tail for various sulfide species shown in Table 1. As seen in Table 2, if one percent of sulfide material of the Lone Tree ore is lost to the tail, and that one percent is framboidal arsenian pyrite, then the corresponding loss of gold to the tail is over three percent, or a loss of gold that is proportionately more than three times the loss of the refractory auriferous sulfide. As seen for Twin Creeks, the loss of framboidal arsenian pyrite results in a loss of gold that

is proportionately more than ten times the loss of the refractory auriferous sulfide. To further illustrate, experience on the Lone Tree, Twin Creeks and other ores indicates gold recoveries in only the 50 to 80 percent range with conventional flotation recoveries of sulfide minerals in the 75 to 95 percent range. For the Twin Creeks ore, 87 to 90 percent flotation gold recovery in the concentrate is not achieved until sulfide sulfur recovery exceeds about 97 percent. By promoting the flotation of the refractory auriferous sulfides, the most difficult-to-float mineralogical/morphological sulfide species, the present invention addresses the need for extremely high sulfide mineral recoveries in the flotation concentrate to obtain acceptable gold recoveries.

Table 2

Sulfide Morphology	Gold Loss (%) per 1.0 % Loss Iron Sulfide	
	Lone Tree	Twin Creeks
Coarse Grained Pyrite	0.03	0.08
Blastic Arsenian Pyrite	0.41	NA ⁽¹⁾
Medium Grained Arsenian Pyrite	0.80	0.36
Fine Grained/Amorphous Arsenian Pyrite	1.71	2.29
Amorphous/Framboidal Arsenian Pyrite	NA ⁽¹⁾	3.79
Framboidal Arsenian Pyrite	3.15 ⁽²⁾	10.7
Arsenian Marcasite	0.56	0.63
Iron-Containing Orpiment	NA	1.11

(1) Not applicable.

(2) Average content from 5 high grade samples from fine grained/amorphous material

One embodiment in accordance with the present invention is shown in Fig. 1. With reference to Fig. 1, a gold-bearing mineral material feed **102** is provided for processing. The mineral material feed **102** may be any gold-bearing material comprising one or more refractory auriferous sulfides, with which refractory gold is predominantly

associated, and from which the refractory gold is difficult to recover because it is not amenable to direct cyanidation. The sulfide species in the mineral material feed **102** could also include one or more nonrefractory sulfide species such as pyrite, marcasite, and pyrrhotite, in addition to the refractory auriferous sulfides, as discussed above. The
5 mineral material feed **102** is typically a whole ore, but may be a residue from other processing or a previously discarded tail.

The mineral material feed **102** is subjected to comminution **104** to obtain a particulate mineral material **106** having mineral particles of a size suitable for flotation. The particulate mineral material **106** is preferably sized such that at least 80 weight
10 percent of particles in the particulate mineral material are smaller than about 100 mesh, more preferably smaller than about 150 mesh, and still more preferably smaller than about 200 mesh. The size at which 80 weight percent of a material passes is often referred to as a P80 size. Any suitable grinding and/or milling operation may be used for the comminution **104**. Wet grinding and/or milling operations are generally preferred due
15 to their relative ease and low cost compared to dry operations.

The comminution **104** is conducted in the presence of a blanketing gas **108** which is obtained from a gas source **110**. During, or prior to, the comminution **104**, the mineral material feed **102** is mixed with the blanketing gas **108**, which contains oxygen gas, if at all, at a lower volume fraction of oxygen gas than is present in ambient air, to reduce
20 problems that could be caused by the presence of air during the comminution **104**. During the comminution **104**, it is preferable to maintain a positive pressure of the blanketing gas **108** into any grinding and/or milling apparatus to assist mixing of the mineral material feed **102** with the blanketing gas **108**, and to displace any air which may have been present with the mineral material feed **102**.

25 After the comminution **104**, the particulate mineral material **106** is subjected to flotation **112** to separate sulfide minerals, including refractory auriferous sulfides, from non-sulfide gangue material. During flotation, a slurry of the particulate mineral material **106** is aerated with a flotation gas **114** from the gas source **110**. Any suitable flotation apparatus may be used for the flotation **112**, such as a one or more of a conventional
30 flotation cell or a flotation column. Preferably, however, the flotation apparatus is such that a small positive pressure of the flotation gas **114** may be maintained in the apparatus

to prevent the entry of air into the apparatus. The flotation gas 114 has oxygen gas, if at all, at a reduced volume fraction relative to the volume fraction of oxygen gas in ambient air, to reduce the problems associated with using air as a flotation gas. Although not required, the flotation gas 114 will normally be of substantially the same composition as the blanketing gas 108 used in the comminution 104. Additionally, normal reagents may be added during or prior to the flotation 112 to assist in flotation separation. Such reagents may include frothing agents, activators, collectors, depressants, modifiers and dispersants. The flotation 112 may be conducted at ambient temperature and a natural pH produced by the mineral material. Operating conditions, such as pH and temperature may, however, be adjusted as desired to optimize flotation separation for any particular mineral material.

Exiting from the flotation 112 is a flotation concentrate 116, which is recovered from the flotation froth and which is enriched in sulfide minerals, and particularly in refractory auriferous sulfides and consequently also in the gold in the refractory auriferous sulfides. Also exiting from the flotation 112 is a flotation tail 118, which is enriched in non-sulfide gangue materials, and consequently contains low levels of refractory gold. The flotation concentrate 116 may be further processed to recover the gold by any suitable technique, if desired. Alternatively, the flotation concentrate 116 may be sold as a valuable commodity for processing by others to recover the gold.

As noted previously, the flotation gas 114 and the blanketing gas 108 each comprise oxygen gas, if at all, at a volume fraction that is less than the volume fraction of oxygen gas in ambient air. Preferably, however, the amount of oxygen gas in the flotation gas 114 and/or blanketing gas 108 is less than about 15 volume percent, and more preferably less than about 5 volume percent. Most preferably, both the flotation gas 114 and the blanketing gas 108 are substantially free of oxygen gas.

To aid in the understanding of the present invention, but not to be bound by theory, it is believed that oxygen gas, if present in any appreciable quantity, tends to oxidize the surface of refractory auriferous sulfides, which can have the effect of depressing flotation of particles of those sulfide species during the flotation 112. By reducing the amount of oxygen gas that comes into contact with sulfide species, it is believed that any surface oxidation effect is reduced, resulting in enhanced flotation of

sulfide species, including refractory auriferous sulfides, and a corresponding increase in the amount of sulfides, and therefore gold, recovered in the flotation concentrate **116**. Therefore, it is preferred that the flotation gas **114** and the blanketing gas **108** consist essentially of components which could not oxidize the surface of sulfide mineral particles, and particularly those including refractory auriferous sulfides.

It is preferred that the flotation gas **114** and the blanketing gas **108** predominantly comprise one or more gases other than oxygen gas. Suitable gases include nitrogen, helium, argon and carbon dioxide. Preferably, one or more of these gases should comprise greater than about 95 volume percent of the flotation gas **114** and the blanketing gas **108**, and more preferably greater than about 98 volume percent. Still more preferable is for the blanketing gas **108** and the flotation gas **114** to consist essentially of one or more of these gases. Nitrogen gas is particularly preferred because of its relatively low cost.

The blanketing gas **108** and/or the flotation gas **114** may be introduced into process apparatus in any appropriate manner. Such gases may be fed under positive pressure or may be induced into the apparatus by creating a suction which pulls the gas in. Preferably, however, the apparatus is designed to substantially prevent introduction of air into comminution and flotation apparatus.

In one embodiment, the possible detrimental effects of any surface oxidation of sulfide mineral particles that may be present in a mineral material feed may be counteracted by the addition of a sulfidizing agent, to at least partially replace the oxidized coating with a sulfide coating. Any material capable of reacting to form the desired sulfide coating of the mineral particle could be used. Suitable sulfidizing agents include alkali metal sulfides and bisulfides, such as Na_2S , NaHS , etc. Such sulfidizing agents could be added during comminution, conditioning just ahead of flotation or during any stage of the flotation **112**.

With the present invention, greater than about 80 weight percent of sulfide minerals from the particulate mineral material **106** may be recovered in the flotation concentrate **116**, and preferably greater than about 90 weight percent of those sulfide minerals are recovered in the flotation concentrate **116**. It should be noted that the flotation according to the present invention is substantially not selective as between

different sulfide species. Rather, flotation according to the present invention typically promotes flotation of substantially all sulfide species present in the feed material. In this way, the hardest sulfide species to float are adequately concentrated in the flotation concentrate.

5 One major advantage of the process of the present invention is that, in addition to permitting a high recovery of refractory auriferous sulfides in the flotation concentrate **116**, it permits a high rejection of gangue material into the flotation tail **118**. Relative to the use of air as a flotation gas, the present invention permits the same recovery of gold to be obtained in a concentrate of smaller weight. This provides a significant economic
10 advantage because less gangue material is present in the concentrate, from which the gold must ultimately be separated to produce a purified gold product, if desired.

The gas source **110** may be any source providing a suitable flotation gas **114** and blanketing gas **108**. One preferred gas source **110** is a facility in which nitrogen gas is separated from air, with the separated nitrogen gas being used as the blanketing gas **108**
15 and the flotation gas **114**. Several processes are known for separating nitrogen from air, including cryogenic separation and membrane separation.

One particularly preferred gas source **110** is an oxygen plant, which is commonly found at existing facilities where gold-bearing refractory sulfide ores are processed. An oxygen plant is typically required, for example, when a pressure oxidation operation or
20 an oxidative roasting operation is used in the processing of gold-bearing sulfide ores. In the oxygen plant, oxygen is separated from air, such as by cryogenic separation or membrane separation, and the separated oxygen gas is used in the pressure oxidation or oxidative roasting operation. A by-product of such an oxygen plant is an effluent gas stream which is enriched in nitrogen gas and is suitable for use as the blanketing gas **108**
25 and/or the flotation gas **114**. This by-product stream has previously been vented to the atmosphere and has, therefore, been wasted. With the present invention, however, the by-product stream may be beneficially used to produce the flotation concentrate **116**, in addition to using the oxygen gas product stream for the pressure oxidation or oxidative roasting operation.

30 Another possibility for the gas source **110** is a nitrogen plant dedicated to producing a nitrogen-enriched gas for use as the blanketing gas **108** and/or the flotation

gas 114. A nitrogen plant differs from an oxygen plant in that the main product stream is a nitrogen-enriched gas stream and the by-product stream is an oxygen-enriched gas stream. The oxygen-enriched gas stream from a nitrogen plant, however, is normally of much lower purity in oxygen than an oxygen-enriched stream from an oxygen plant. The
5 nitrogen plant may be based on separation of air into a nitrogen-enriched stream and an oxygen-enriched stream by membrane separation, cryogenic separation or otherwise.

Another possibility for the gas source 110 is a burner or other combustion device to produce combustion exhaust gases that are substantially depleted in oxygen. For example, the gas source 110 could be exhaust from an electrical power generator used to
10 generate power for a mine or mineral processing facility. When using combustion exhaust gases as the blanketing gas 108 and/or the flotation gas 114, it is preferred that the fuel combusted to produce the gases be a clean-burning fuel such as natural gas, propane or another liquefied petroleum gas, or an alcohol such as methanol or ethanol. Although less preferred, other fuels could be used such as coal or fuel oils, including
15 diesel fuel.

Yet another possibility for the gas source 110 is gas generated during acid pre-treatment of a mineral material feed 102 comprising carbonate minerals. Carbon dioxide gas is generated from decomposition of the carbonate minerals. The carbon dioxide may be used as the blanketing gas 108 and/or the flotation gas 114. Such an embodiment is
20 shown in Fig. 10. As shown in Fig. 10, the mineral material feed 102 is subjected to comminution 104 to form the particulate mineral material 106. The particulate mineral material 106 is then subjected to an acid pre-treatment 150 where acid 152 is added to the particulate mineral material 106 to decompose carbonate minerals present in the particulate mineral material 106. The particulate mineral material 106 remaining
25 following the acid pre-treatment is subjected to flotation 112, to form the flotation concentrate 116 and the flotation tail 118. During the acid pre-treatment 150, a gas that is enriched in carbon dioxide and deficient in oxygen is produced, which is used as the blanketing gas 108 and the flotation gas 114. An alternative to acid pretreatment of the mineral material feed 102 is to use gases produced during acid pretreatment of another
30 carbonate-containing mineral material, such as a whole ore, prior to pressure oxidation. Such an embodiment is shown in Fig. 28.

A still further possibility for the gas source **110** is to have liquid or compressed nitrogen, carbon dioxide or another gas delivered to the site.

In one preferred embodiment of the present invention, the flotation gas **114** is made up, at least in part, of recycled gas from the flotation **112**. One such embodiment is shown in Fig. 11, where a recycle gas **156** from the flotation **112** is used as part of the flotation gas **114**. In this manner, make-up flotation gas **114** from the gas source **110** may be kept to a minimum. This recycling of gas from the flotation **112** provides the benefits of reducing the amount of make-up gas that needs to be supplied by the gas source **110** and reduces emission of oxygen-deficient gas from the flotation **112**. Reducing the emission of oxygen-deficient gas from the flotation **112** is particularly important when the flotation **112** is conducted in an enclosed structure where people are present, so that ambient air in the structure does not become seriously deficient in oxygen. In that regard, oxygen monitors should be placed in any such enclosed structure to ensure that sufficient oxygen is present for human needs.

Fig. 12 shows features of one embodiment of a flotation apparatus **160** that may be used with the present invention to accomplish recycling of flotation gas. As shown in Fig. 12, the flotation apparatus **160** has a sealed flotation tank **162**, above which is mounted a motor **164** for rotating a shaft **166** extending down into the flotation tank **162** to drive an impeller **168**. When the flotation apparatus **160** is operating, a vapor headspace **170** exists above a liquid column **172**. Gas from the vapor headspace **170** is withdrawn via a conduit **174** by a blower **176** to be forced through a conduit **178** for use as flotation gas. The flotation gas from conduit **178** is forced through an annular conduit **180** to the vicinity of the impeller **168** so that the flotation gas may be adequately distributed and dispersed throughout the liquid column **172**. Make-up flotation gas is provided via conduit **182** to compensate for any system losses of flotation gas.

Fig. 13 shows features of another embodiment of the flotation apparatus **160** for effecting recycle of flotation gas. In the embodiment shown in Fig. 13, the flotation apparatus **160** is designed such that a blower is not used. Instead, the conduit **174** collects gases from the overhead vapor space **170** and cycles the gas to the annular conduit **180** for use as a flotation gas. The action of the impeller **168** causes a vacuum in the annular conduit **180** creating sufficient suction to draw the flotation gas through

the conduit 174 at a sufficiently high rate. This type of flotation apparatus 160 design, therefore, is self-inducing with respect to the introduction of flotation gas and does not require a blower or other gas compression device. Cycling of the flotation gas without the use of a blower is important because the recycled flotation gas will normally contain
5 a significant amount of acid or corrosive mists or corrosive gases that could significantly corrode interior surfaces of a blower.

Referring again to Fig. 1, as noted previously, the flotation 112 may be performed at a natural pH. It has been found, however, that it is preferred that the flotation 112 be conducted at an acidic pH, and preferably at an acidic pH that is lower than about pH 6.
10 Even more preferred is a flotation pH range of from about pH 3 to about pH 6, and most preferred is a pH range of from about pH 5 to about pH 6. Control of the pH may be accomplished by the addition of an acid or a base as necessary to adjust the pH to within the desired range. For example, sulfuric acid and/or any other acid could be added to the flotation 112 to lower the pH and lime, sodium carbonate, caustic or any other base could
15 be added during the flotation 112 to raise the pH. Acid for reducing the pH could come from other mineral processing steps, such as pressure oxidation or bio-oxidation, as discussed below. Furthermore, acidification could be accomplished by introducing sulfur dioxide into the flotation 112. In its dissolved state in water, sulfur dioxide forms sulfurous acid. The sulfur dioxide could be provided by exhaust gas from a sulfur burner.

As noted previously, various reagents may be used during the flotation 112. It has
20 been unexpectedly found, however, that copper-based activators generally do not perform as well as lead-based activators used during the flotation 112. Lead-based activators should contain lead in an oxidation state of +2. One preferred activator is lead nitrate. Another preferred activator is lead acetate. One benefit of using a lead-based activator,
25 relative to the use of a copper-based activator such as copper sulfate, is that higher recoveries are experienced in the flotation concentrate 116 for both sulfide minerals and gold. Also, if the flotation tail is subjected to cyanide leaching, as discussed below, the use of a lead-based activator provides the additional advantage of lowering cyanide consumption during the leaching operation relative to a copper-based activator. An
30 added advantage is that cyanide consumption for eventual cyanide leaching of gold

contained in the flotation concentrate **116**, such as after pressure oxidation, will be lower with the use of a lead-based activator compared to the use of a copper-based activator.

Another reagent that has been found to be particularly useful in the flotation **112** is a xanthate collector. The appropriate xanthate collector may be provided by addition
5 to the flotation **112** of a xanthate salt such as potassium amyl xanthate or sodium isopropyl xanthate. The enhanced performance through use of a xanthate collector reagent is significantly greater than would normally be expected, especially when compared to the performance of other widely used collector reagents.

When the mineral material feed **102** contains a significant amount of organic
10 carbon, the organic carbon can significantly detrimentally interfere with recovery of gold and sulfide minerals in the flotation concentrate **116**. To reduce the detrimental effects of organic carbon, when present in the mineral material feed **102**, it has been found to be advantageous to add an oil to the flotation **112**. Examples include an aromatic oil, such as moly collecting oil, commonly referred to as MCO, or a nonaromatic oil such as No.
15 2 diesel.

As discussed above, the comminution **104** is conducted in the presence of the blanketing gas **108**. With reference now to Fig. 14, one embodiment of a comminution circuit is shown. As shown in Fig. 14, the mineral material feed **102** is fed to a first comminution unit **186**, such as a sag mill. In the first comminution unit **186**, the mineral
20 material particles in the mineral material feed **102** are reduced in size. Output from the first comminution unit **186** passes through a trommel screen **188** in a sealed discharge box **190**. Blanketing gas **108** is fed into the discharge box **190** so that the blanketing gas will flow back through the first comminution unit **186** in counter-flow with the mineral material feed **102**, to ensure removal of air from the mineral material feed **102**. Material
25 exiting the discharge box goes to a tank **192** for delivery to a cyclone separator **194** via a pump **196**. The cyclone separator **194** classifies the mineral material by particle size into an overflow **198** of smaller-size particles and an underflow **200** of larger-size particles. The underflow **200** is then fed to sealed feed box **201** of a second comminution unit **202**, such as a ball mill, to further reduce the size of mineral material particles in the
30 underflow **200**. Discharge from the second comminution unit **202** passes through a trommel screen **204** in a sealed discharge box **206**. Blanketing gas **108** is fed into both

the feed box **201** and the discharge box **206**. Material exiting the discharge box **206** goes to a tank **208** where it is combined with the overflow **198** from the cyclone separator **194**. Discharge from the tank **208** goes to a cyclone separator **210** via a pump **212**. The cyclone separator **210** makes a size separation of particles into an overflow **214** comprising smaller-size particles and an underflow **216** comprising larger-size particles. The underflow **216** from the cyclone separator **210** is fed to the second comminution unit **202** along with the underflow **200** from the cyclone separator **194**. The overflow **214** from the cyclone separator **210** goes to the tank **218** where particulate mineral material in the overflow **214** may be held for feed to flotation processing.

It should be noted that, as shown in Fig. 14, all process equipment is sealed except for feed into the comminution unit **186**. Furthermore, the blanketing gas **108** is introduced at various points in the comminution system to ensure that minimal air makes its way into the system. As shown in Fig. 14, the blanketing gas **108** is specifically fed to the discharge box **190** of the first comminution unit **186**, to the tanks **192**, **208** and **218**; to the cyclone separators **194** and **210**; and to the feed box **201** and the discharge box **206** of the second comminution unit **202**.

In addition to maintaining the comminution environment in the absence of any significant quantities of air, it is important to the performance of subsequent flotation operations that the effects of galvanic interaction be reduced as much as possible during comminution of the mineral material feed **102**. Such galvanic interactions are due to different electrochemical activities at different material surfaces. The combination of a cathodic surface (i.e., pyrite, pyrrhotite, arsenian pyrite, etc.) and an anodic surface (i.e., iron from comminution media or from steel walls of mill liners) results in the creation of galvanic cell during the comminution processing. Galvanic cells also exist between different sulfide minerals that may be present in the mineral material feed, with the sulfide mineral with the higher rest potential acting as the cathode and the sulfide mineral with the lower rest potential acting as the anode. For example, the galvanic interaction between grinding iron and various forms of refractory auriferous sulfides, and especially arsenian iron sulfides, can be represented by the following reactions:

grinding iron surface (anode):



refractory auriferous sulfide surface (cathode):



5 For example, during grinding, galvanic cells are created every time a refractory
 auriferous sulfide surface comes into contact with grinding media, mill liners, abraded
 tramp iron or any other metal sulfide at a lower or higher rest potential. These galvanic
 interactions create hydroxide coatings on the surfaces of the refractory auriferous sulfides,
 depressing their floatability. According to the present invention, such detrimental
 10 galvanic interactions can be hindered by reducing the amount of oxygen present during
 comminution through use of the blanketing gas **108**.

It has been found, however, that, in addition to reducing the amount of oxygen
 present during the comminution operation, improved flotation results may be obtained
 by further limiting iron contamination of the mineral material being processed. The
 15 combination of reducing the amount of iron introduced into the mineral material and the
 use of the blanketing gas **108** provides an increase in gold recovery in the flotation
 concentrate that would be unexpected based on the contributions of each alone.

One way to reduce the amount of iron available for galvanic interactions during
 the comminution processing is to use comminution media made of a chromium or nickel
 20 hardened steel or a corrosion-resistant steel, such as stainless steel. Although ceramic
 comminution media could be used, ceramic comminution media are typically not of
 sufficient density for effective comminution.

Another way to reduce detrimental galvanic effects from iron is to provide all
 comminution equipment, such as grinders and mills, with non-metallic liners, and
 25 preferably with rubber liners.

A further, and preferred method for reducing detrimental galvanic interactions
 caused by iron during flotation is to perform a magnetic separation step after
 comminution and prior to flotation. Referring to Fig. 15, an embodiment is shown
 including a magnetic separation step after comminution. As shown in Fig. 15, the
 30 mineral material feed **102** is first subjected to comminution **104**, followed by magnetic

separation **230** to remove particles of magnetic material **232** from the mineral material **106**.

As an alternative to the embodiments discussed thus far, it should be noted that many of the advantages of the present invention may be obtained even without the use of the blanketing gas **108**. In that regard, most conventional comminution circuits utilize equipment that freely permits air to enter into the system. With the present invention, however, when it is not practical or economic to use a blanketing gas, enhanced performance may still be obtained by sealing all equipment involved with comminution processing so that substantially the only oxygen entering into the comminution processing enters with the mineral material feed **102** to be processed. In that regard, such a comminution system could be substantially as described with respect to Fig. 14, with all process equipment sealed to prevent the entry of air and with no blanketing gas **108** being fed to the process equipment. Oxygen already present in the mineral material feed **102** would be consumed through oxidation of surfaces of sulfide mineral particles exposed during comminution. Once all of that original oxygen had been consumed, however, the continued detrimental effects of oxygen would be substantially eliminated. Although this mode of operation is not as preferable as using the blanketing gas **108**, it is preferred to a system that it is open to the introduction of air, as is commonly practiced.

To further reduce the amount of oxygen introduced in the system to reduce the detrimental effects of surface oxidation of sulfide minerals and of galvanic interactions, it is preferred that process water used to slurry mineral material for comminution processing and/or flotation processing has been deoxygenated. Deoxygenation of process water can significantly enhance recovery in the concentrate of sulfide minerals and gold during flotation processing. The deoxygenation may be performed in any convenient manner, such as by bubbling an inert stripping gas, such as nitrogen or carbon dioxide, through the process water to remove oxygen from the process water or by adding an oxygen scavenger to the water to tie-up the oxygen. It has been found that a flotation tank works well for deoxygenation, with nitrogen or carbon dioxide being introduced into the vessel to perform the oxygen stripping function. Alternatively, the inert stripping gas could be sparged into a tank containing the process water. Preferably, the process water should be deoxygenated to a dissolved oxygen level that is less than about 2.0, most

preferably less than about 1.0, and most preferably less than about 0.5, parts per million of oxygen by weight.

Also, with the present invention it is possible to use recycled water as process water. When recycled water is used, however, it is important that an activator be used
5 during flotation processing. This is because any cyanide in the recycle water that is available for reaction with sulfide sulfur or sulfide minerals will tend to depress flotation of the sulfide minerals and, accordingly, reduce the recovery of gold in the concentrate. The activators, however, counter the depressing effect that cyanide has on flotation. Also, the recycle water may be treated with a material such as ammonium bisulfite, sulfur
10 dioxide, a peroxide, Caro's acid or any other known cyanide destruction technology used to destroy the cyanide prior to using the recycle water for flotation.

As noted with respect to Fig. 1, one preferred gas source **110** for the blanketing gas **108** and the flotation gas **114** is an oxygen plant. Fig. 2 shows one embodiment of the present invention in which both the oxygen gas product stream and the nitrogen gas
15 by-product stream from an oxygen plant are both used to process gold-bearing sulfide mineral material. Referring to Fig. 2, particulate mineral material **110** is subjected to the flotation **112** to produce the flotation concentrate **116** and the flotation tail **118**, as previously described. The flotation gas **114** is a nitrogen gas enriched by-product stream from an oxygen plant **130**, in which air **132** is separated into an oxygen enriched gas stream (treating gas **128**) and nitrogen enriched gas stream (flotation gas **114**).
20

The flotation concentrate **116**, which is enriched in refractory auriferous sulfides, is subjected to pressure oxidation **124** to decompose sulfide minerals, producing an oxidized material **126** from which the gold could be recovered by dissolution using any suitable gold lixiviant, such as a cyanide. The pressure oxidation **124** involves treating
25 a slurry of the flotation concentrate **116** in an autoclave at a temperature of greater than about 150°C and an elevated pressure in the presence of an overpressure of a treating gas **128**, which is rich in oxygen. It should be noted that other oxidative treating steps could be used instead of the pressure oxidation **124**. For example, an oxidative roasting or bio-oxidation could be used to produce the oxidized material **126** using the treating gas **128**.

30 A further embodiment in accordance with the present invention is shown in Fig. 3 which uses the product and by-product gas streams from an oxygen plant to process a

gold-bearing sulfide mineral material provided in two separate feed streams. Referring to Fig. 3, a particulate first mineral material feed 138 is subjected to the flotation 112 to produce the flotation concentrate 116 and the flotation tail 118, as previously described. The flotation gas 114 is a gas stream enriched in nitrogen from the oxygen plant 130. A
5 particulate second mineral material feed 140 is combined with the flotation concentrate 116 in a mixing step 142. The combined stream 144, in the form of a slurry, is subjected to the pressure oxidation 124 to produce the oxidized material 126, from which gold could be recovered.

One advantage of the embodiment shown in Fig. 3 is that it permits the processing
10 of multiple ores having different characteristics. For example, the first mineral material feed 138 may comprise a lower grade refractory sulfide ore than the second mineral material feed, which may comprise a higher grade refractory sulfide ore. The higher grade ore may be suitable for pressure oxidation in a whole ore form, whereas the lower grade ore must be upgraded to a concentrate form to be suitable for pressure oxidation.

Alternatively, the second mineral material feed may comprise a refractory sulfide
15 ore which has a significant amount of carbonate material which would require acid to be added prior to pressure oxidation 124, and which could, therefore, cause high operating costs compared to ores with low carbonate levels detrimentally interfere with proper operation of the pressure oxidation 124. A high sulfide sulfur content in the flotation
20 concentrate 116, however, tends to produce additional acid during pressure oxidation to at least partially offset the acid consuming effect of carbonate material in the second mineral material feed. Most of the carbonate material that may have been present in the first mineral material feed, if any, would ordinarily have been removed during the flotation 112.

With the present invention, most of the gold reports to the flotation concentrate. Gold in the concentrate, which is typically substantially all refractory gold associated with one or more refractory auriferous sulfides, may then be freed for recovery operations by oxidative processing, such as pressure oxidation, oxidative roasting or bio-oxidation. Many mineral material feeds, however, contain a significant amount of gold that is not
30 associated with a sulfide mineral. For example, it is not uncommon for a gold-bearing refractory sulfide ore to also contain some gold in association with oxidized minerals or

silica. Up to 50%, and in some instances even more, of the gold in a refractory sulfide ore may be associated with minerals other than sulfide minerals. Also, refractory sulfide ores that have been stockpiled for a significant amount of time, and therefore exposed to air for a significant amount of time, may contain even larger amounts of gold that are no longer held by the refractory auriferous sulfides. This is because a significant amount of a refractory auriferous sulfide may become oxidized so that a significant quantity of the gold is no longer associated with the refractory auriferous sulfide. For example, a refractory sulfide ore stockpiled for several months may oxidize to a degree where 20% to 30% or more of the gold is no longer associated with refractory auriferous sulfide.

It has been found that the present invention works very well for the treatment of mineral material feeds having both refractory gold associated with sulfide minerals and non-refractory gold that is not associated with sulfide minerals. Gold that is not associated with sulfide minerals, and especially gold associated with oxidized minerals, may be recovered following flotation processing by leaching of the flotation tail. Although any compatible leaching operation may be used, a preferred leaching operation is cyanide leaching. One embodiment of the present invention involving a leach of the flotation tail is shown in Fig. 16.

With reference to Fig. 16, a mineral material feed **102** is provided having both refractory gold, in refractory auriferous sulfides, and non-refractory gold that is not associated with sulfide minerals, and, therefore, will not float along with sulfide minerals. The mineral material feed **102** is subjected to comminution **104** to prepare the particulate mineral material **106**, which is then subjected to flotation **112**. Following the flotation **112**, the flotation tail **114** is subjected to oxygenation **240** followed by a leach **242** of the flotation tail **114**. Preferred for the leach **242** is a carbon-in-pulp cyanide leach, although a carbon-in-leach cyanide leach could be used instead. Exiting from the leach **242** is loaded carbon **244** that is loaded with gold. Also exiting from the leach **242** is a leach tail **246** that is depleted in gold. The loaded carbon **244** may be processed in any known manner for recovery of the gold.

With continued reference to Fig. 16, the comminution **104** and the flotation **112** are performed in the presence of the blanketing gas **108** and the flotation gas **114**, respectively, supplied from the gas source **110**. As also shown in Fig. 16 process water

248 is subjected to deoxygenated prior to using the process water 248 in the process. Therefore, according to the embodiment shown in Fig. 16, the process water 248 is first deoxygenated in the deoxygenation step 250 and, following the flotation 112, the water with the flotation tail 118 is then oxygenated in the oxygenation step 240 prior to the
5 leach 246. The oxygenation 240 may be accomplished in any manner suitable for increasing the amount of oxygen dissolved in the liquid of the slurry of the flotation tail 118. Typically, the slurry of the flotation tail 118 is subjected to sparging or bubbling with air or an oxygen-enriched gas. Oxygenation 240 may be conducted using air or an oxygen-enriched gas, such as would be suitable for pressure oxidation processing, as
10 previously discussed. Although the embodiment described with respect to Fig. 16 includes deoxygenation of process water, such deoxygenation is not required. The use of deoxygenated process water does, however, tend to improve gold recovery from the process.

The ability to successfully leach the flotation tail 118, as shown in Fig. 16, results
15 from the efficient separation of sulfide minerals into the concentrate during the flotation 112. If a significant amount of sulfide mineral were to report to the flotation tail 118, then performance of the leach 242 could be significantly impaired because sulfide sulfur from the sulfide mineral would consume cyanide during a cyanide leach. Also, refractory gold in the flotation tail associated with the refractory auriferous sulfides would not be
20 leachable. With the present invention, however, cyanide consumption is reduced during the leach 242 because of the efficient reporting of sulfide minerals to the flotation concentrate 116 and the relative absence of sulfide minerals in the flotation tail 118.

Another significant advantage of the process of the present invention is that it permits interim regrinding of particulate mineral material between flotation stages (to
25 enhance gold recovery in the concentrate). Such intermediate grinding can significantly enhance recovery of refractory gold in refractory sulfide auriferous mineral fragments locked in middling particles. By comparison, with conventional flotation using air as the flotation gas, such intermediate grinding would further reduce the floatability of refractory auriferous sulfides due to the detrimental effects of oxygen.

30 Fig. 17 shows a process diagram for one embodiment according to the present invention involving regrinding of particulate mineral material intermediate between

flotation stages. As shown in Fig. 17, a mineral material feed **102** is subjected to a first comminution step **254** to produce a particulate mineral material **106**, which is then subjected to a first flotation stage **256**. The first flotation stage **256** includes rougher flotation **258** and rougher scavenger flotation **260**. In the rougher flotation **258**, the particulate mineral material **106** is separated by flotation into a rougher concentrate **262**, which forms part of a final concentrate **264**, and a rougher tail **266**, that is fed to the rougher scavenger flotation **260**. The rougher scavenger flotation produces a rougher scavenger concentrate **268** and a rougher scavenger tail **270**. The rougher tail **266**, the rougher scavenger concentrate **268** and the rougher scavenger tail **270** often include a substantial amount of middling particles. Such middling particles include refractory auriferous sulfides locked with gangue material, such as silica. Additionally, the rougher scavenger tail **270** will typically include a substantial amount of very fine slime particles.

To remove the slime particles and to permit recovery of the sulfide mineral fragments from middling particles, the rougher scavenger tail **270** is subjected to a size separation **274**, such as may be accomplished using a screen or a classifying cyclone. A first fraction **276**, comprising the smaller-size slime particles becomes part of a final tail **278**. For example, a 500 mesh screen may be used in the size separation **274** with all particles passing through the screen being sent to the final tail **278** as slimes.

A second fraction **280** from the size separation **274**, which comprises larger-size particles, is sent to a second comminution step **284** along with the rougher scavenger concentrate **268**. In the second comminution step **284**, particles are comminuted to a smaller size to break up middling particles and liberate sulfide mineral fragments, including fragments of refractory auriferous sulfides. The reground mineral material **286** is sent to a second flotation stage **290** for concentration of the sulfide mineral fragments liberated from middling particles. The second flotation stage **290** includes cleaner flotation **292** and cleaner scavenger flotation **294**. In the cleaner flotation **292**, a cleaner concentrate **296** is produced, which is sent to form part of the final concentrate **264**. The cleaner flotation **292** also produces a cleaner tail **298** which is sent to the cleaner scavenger flotation **294**. In the cleaner scavenger flotation **294**, a cleaner scavenger concentrate **300** is prepared, which is recycled to the second comminution step **284** for

further processing. The cleaner scavenger flotation 294 also produces a cleaner scavenger tail 302 that is sent to form part of the final tail 278.

Also shown in Fig. 17 is the gas source 110 that supplies blanketing gas 108 to the first comminution step 254, the second comminution step 284 and the size separation 274. The gas source 110 also provides flotation gas 114 to the rougher flotation 258, the rougher scavenger flotation 260, the cleaner flotation 292 and the cleaner scavenger flotation 294. Use of the blanketing gas 108 and the flotation gas 114 substantially prevents problems that could occur if comminution and/or flotation operations were conducted in the presence of air. Furthermore, because the detrimental effects from air are reduced, it is possible to have the second comminution step 284 intermediate between the first flotation stage 256 and the second flotation stage 290 without destroying the floatability of sulfide minerals in the reground mineral material 286. The second comminution step 284 significantly improves performance of the flotation circuit. This is because it will not be necessary to comminute all of the mineral material feed 102 to a very fine size that may be required for liberating refractory auriferous sulfides from middling particles in the first comminution step 254. Having a coarser grind for the particulate mineral material 106 is significantly less expensive than comminuting all of the mineral material feed 102 to a size small enough to liberate refractory auriferous sulfide mineral fragments from middling. Also, a coarser comminution to produce the particulate mineral material 106 simplifies operation of the first flotation stage. Middling particles from the first flotation stage 256 are then further comminuted in the second comminution step 284 to liberate the locked refractory auriferous sulfide mineral fragments for recovery in the second flotation stage 290.

The present invention is further described by the following examples, which are intended to be illustrative only and are not intended to limit the scope of the present invention.

EXAMPLES

Examples 1-6

Examples 1-6 demonstrate the use of nitrogen gas as a flotation gas during flotation of a gold-bearing sulfide ore to produce a sulfide enriched concentrate which

could be further processed to recover refractory gold in refractory auriferous sulfides, if desired.

For each of Examples 1-6, an ore sample is provided from Santa Fe Pacific Gold Corporation's Lone Tree Mine in Nevada. The ore samples are of a low grade refractory sulfide ore which would be unsuitable for economic pressure oxidation in a whole ore form. A representative assay of an ore sample is shown in Table 3.

TABLE 3

LONE TREE LOW GRADE REFRACTORY ORE REPRESENTATIVE HEAD ANALYSIS	
Gold	0.063 oz/st ⁽¹⁾
Silver	0.05 oz/st ⁽¹⁾
Total Sulfur	1.75 wt. %
Sulfide Sulfur	1.66 wt. %
Arsenic	1440 ppm. by wt.

⁽¹⁾ ounces per short ton of ore

For each example, the ore sample is ground to the desired size. A first portion of the ore sample is subjected to flotation in a laboratory-scale flotation cell using air as the flotation gas. A second portion of the ore sample is subjected to flotation under the same conditions, except using a flotation gas which consists essentially of nitrogen gas. During each flotation test, a flotation froth is collected from the top of the flotation cell to recover a flotation concentrate which is enriched in sulfide minerals, including refractory auriferous sulfides, and which is, therefore, also enriched in gold. The flotation tail is that material which is not collected in the froth. For each flotation test, the flotation conditions are substantially as follows: A natural pH and addition of potassium amyl xanthate and mercaptobenzothiazole as collectors, copper sulfate for activation of sulfides and MIBC as a frother. Flotation times range from 20 to 30 minutes.

The results for examples 1-6 are shown tabularly in Table 4 and graphically in Figs. 4-7 and reveal a significant increase in the amount of gold recovered in the concentrate when nitrogen gas is used as the flotation gas, especially at smaller grind sizes.

TABLE 4

LONE TREE LOW GRADE BATCH TESTS									
Example	Grind P80 Mesh ⁽¹⁾	Concentrate Grade oz gold/st ⁽²⁾		Tail Grade oz gold/st ⁽³⁾		Concentrate Recovery wt. % ⁽⁴⁾		Gold Reporting to Concentrate % ⁽⁵⁾	
		air	nitrogen	air	nitrogen	air	nitrogen	air	nitrogen
1	100	0.31	0.35	0.019	0.020	15	15	75	75
2	150	0.28	0.31	0.021	0.016	15	16	71	79
3	200	0.33	0.29	0.021	0.016	15	19	74	81
4	270	0.22	0.25	0.022	0.012	20	24	72	86
5	325	0.23	0.20	0.022	0.016	20	25	73	81
6	400	0.14	0.14	0.029	0.012	29	33	67	85

- 10 (1) 80 weight percent of material passing the indicated size
 (2) ounces of gold per short ton of concentrate
 (3) ounces of gold per short ton of tail
 (4) weight percent of ore sample feed reporting to concentrate
 (5) % of gold in ore sample feed reporting to concentrate

15 Fig. 4 graphically shows the grade of the flotation concentrate (measured as ounces of gold per short ton of concentrate material) as a function of the grind size. As seen in Fig. 4, no identifiable effect on the grade of the concentrate is apparent from using nitrogen gas relative to using air in the flotation. Fig. 5, however, shows that the flotation tail, at smaller grind sizes, contains a significantly lower gold value when using nitrogen gas as a flotation gas than when using air. Therefore, when using nitrogen gas, more of the refractory auriferous sulfides are recovered in the concentrate, apparently without any detrimental effect to the grade of the concentrate recovered. Fig. 6 shows that the amount of material recovered in the concentrate may be significantly higher when using nitrogen gas as a flotation gas than when using air, especially at the smaller grind sizes. Fig. 7 shows that gold recovery in the concentrate may be increased by almost 15% at a P80 grind of 270 mesh, when using nitrogen gas as a flotation gas as opposed to air, again without detrimental effect to the grade of concentrate recovered.

20
25

It should be noted that at a P80 grind of 100 mesh, there is no significant difference in flotation performance when using nitrogen gas as opposed to air as the flotation gas. It is, therefore, surprising and unexpected that the performance using nitrogen gas would improve so markedly relative to air at the smaller grind sizes. Typically, it is expected that flotation performance should improve with a smaller grind size due to a more complete liberation of sulfide minerals from non-sulfide gangue material. As seen in Fig. 7, however, the gold recovery in the concentrate when using air as the flotation gas is flat, at best. When using nitrogen gas, however, gold recovery generally increases with decreased grind size due to increased sulfide mineral particle liberation, including refractory auriferous sulfides, as would normally be expected.

One way to explain the unexpectedly poor flotation performance when using air, to assist in the understanding in the present invention but not to be bound by theory, is that some detrimental chemical process may be occurring when air is used as a flotation gas, with the detrimental chemical process counteracting the normally beneficial effects of a smaller grind size. It was observed that when air is used as the flotation gas, the pH of the slurry in the flotation cell drops rapidly for several minutes, sometimes falling by as much as 0.5-2 pH units. Therefore, it appears that oxygen in the air may be oxidizing the surface of sulfide mineral particles, and particularly those of refractory auriferous sulfides, producing sulfuric acid and lowering the slurry pH. Such surface oxidization of the sulfide mineral particles could render them less responsive to flotation. As the grind becomes smaller, the surface area available for oxidation of the sulfides increases significantly and, accordingly, any beneficial effect from more complete liberation of sulfides due to the smaller grind size is offset by increased surface oxidation, further depressing flotation of the refractory auriferous sulfides. Nitrogen gas, however, would not oxidize the surface of sulfide minerals and, therefore, permits better flotation of sulfide mineral particles, resulting in a higher recovery of sulfide minerals at the smaller grind sizes, as would normally be expected.

Example 7

This example further demonstrates the beneficial use of nitrogen gas in the flotation of gold-bearing refractory sulfide ores, and the use of a rougher-scavenger-cleaner arrangement of flotation to enhance recovery of concentrate.

A flotation pilot plant is operated using a low grade refractory sulfide ore from the Lone Tree Mine, as previously described with Examples 1-6. The pilot plant flow is shown in Fig. 8.

5 With reference to Fig. 8, the ore sample **166** is subjected to comminution **168** in a ball mill to a P80 size of 270 mesh. The ground ore, in a slurry **170**, is introduced into a rougher flotation step **172**. In the rougher flotation step **172**, an initial flotation separation is made with a rougher concentrate **174** being collected with the flotation froth and a rougher tail **176** being sent to a scavenger flotation step **178**, material collected in the flotation froth of the scavenger flotation step **178** is repulped and introduced, as a
10 slurry **179**, to a cleaner flotation step **180**, where a final flotation separation is made to produce a cleaner concentrate **182** from the froth and a cleaner tail **184**. The cleaner tail **184** is combined with a scavenger tail **186**, from the scavenger flotation step **178**, to produce the final tail **188**. The rougher concentrate **174** and the cleaner concentrate **182** are combined to form a final concentrate **190**. In this example, the rougher flotation step
15 **172** is accomplished in a single dual compartment flotation cell, the scavenger flotation step **178** is accomplished in a series of three dual compartment flotation cells, and the cleaner flotation step **180** is accomplished in a series of three dual compartment flotation cells. As shown in Fig. 8, nitrogen gas **192** is supplied from gas tank **194** and is fed to each of the comminution step **168**, the rougher flotation step **172**, the scavenger flotation
20 step **178** and the cleaner flotation step **180**. The nitrogen gas **192** is used as the flotation gas in each of the flotation steps and is used as a blanketing gas to prevent air from oxidizing ore particles during the comminution **168**. The nitrogen gas is also used to blanket all other process equipment, not shown, such as pumps and mixing tanks. Refractory auriferous sulfides in the ore sample **166** are, therefore, maintained in a
25 substantially air-free environment through the entire pilot plant, until the refractory auriferous sulfides have been recovered in a desired concentrate product.

The results of the pilot plant are shown in Table 5, which shows that the final concentrate **190** from the pilot plant is of a higher quality than the concentrates shown in Examples 1-6. Addition of the scavenger flotation step **178** and the cleaner flotation step
30 **180** in the pilot plant significantly improves the grade of concentrate finally recovered, without any appreciable loss of gold recovery.

TABLE 5

LONE TREE PILOT PLANT					
Example	Grind P80 Mesh ⁽¹⁾	Final Concentrate Grade oz gold/st ⁽²⁾	Tail Grade oz gold/st ⁽³⁾	Final Concentrate Recovery wt % ⁽⁴⁾	Gold Reporting to Final Concentrate % gold recovery ⁽⁵⁾
7	270	0.57	.0095	9.4	86.4

- 5 (1) 80 weight percent of material passing the indicated size
 (2) ounces of gold per short ton of respective concentrate
 (3) ounces of gold per short ton of final tail
 (4) weight percent of ore sample feed reporting to respective concentrate
 (5) % of gold in concentrate relative to feed for the respective flotation step

10 Example 8

Laboratory tests are performed on samples of a low grade gold-bearing refractory sulfide ore from Santa Fe Pacific Gold Corporation's Twin Creeks Mine in Nevada. A representative analysis of an ore sample is shown in Table 6. For each test, a sample is ground to the appropriate size and a portion of each sample is then subjected to flotation using air as a flotation gas and another portion is subjected to flotation using nitrogen as a flotation gas. Substantially the same flotation conditions are used as described for Examples 1-6.

TABLE 6

Twin Creeks LOW GRADE REFRACTORY SULFIDE ORE REPRESENTATIVE HEAD ANALYSIS	
Gold	0.085 oz/st ⁽¹⁾
Silver	0.28 oz/st ⁽¹⁾
Total Sulfur	6.45 wt. %
Sulfide Sulfur	6.27 wt. %
25 Arsenic	1630 ppm by wt.

- (1) ounces per short ton of ore

The results of Example 8 are graphically shown in Fig. 9 which shows a plot of gold recovery in the concentrate as a function of grind size. As seen in Fig. 9, the use of nitrogen gas generally results in a significantly higher recovery of gold in the concentrate compared to the use of air as a flotation gas.

Examples 9-28

These examples demonstrate the importance of flotation pH and the choice of activators for use during flotation with the present invention.

A series of laboratory flotation tests are performed using Lone Tree low grade
5 gold-bearing refractory sulfide ore samples. Prior to flotation, each sample is ground to
a p80 size of about 60 microns. One series of tests are performed using a nitrogen
atmosphere in the grind and nitrogen flotation gas with varying flotation pH using lead
nitrate as an activator. A second series of tests are performed using air as the grinding
atmosphere and air as the flotation gas at varying flotation pH's and using lead nitrate as
10 an activator. A third series of tests are performed using nitrogen as the grinding
environment and nitrogen flotation gas with varying flotation pH and using copper sulfate
as an activator. The pH is adjusted by either the addition of sulfuric acid or calcium
hydroxide, as required. Also, other normal flotation reagents are used in each test.
Conditions for the grind and flotation for each example are shown in Table 7 and specific
15 reagents used with each example are shown in Table 8.

Results of the flotation are shown tabularly in Table 9 and graphically in Figs. 18-
20. Fig. 18 has plots of sulfide sulfur recovery in the flotation concentrate versus
flotation pH for each of the three test series. Fig. 19 has plots of gold recovery in the
flotation concentrate versus flotation pH for each of the three test series. As seen in
20 Tables 7-9 and Figs. 18 and 19, grinding and flotation using nitrogen gas provides
significantly enhanced performance relative to air for all but the highest pH's.
Furthermore, gold recoveries in the concentrate are best at acidic pH's, and particularly
at pH's below about 6. Moreover, quite surprisingly, lead nitrate as an activator
consistently shows a significantly higher gold recovery in the concentrate than the more
25 standard activator of copper sulfate.

Fig. 20 includes a plot of the difference in percentage gold recoveries in the
concentrate using nitrogen versus air for various flotation pH's and a plot of the difference
in percentage recovery of sulfide sulfur in the concentrate using nitrogen versus air for
various flotation pH's. A dramatic effect of pH is revealed in Fig. 20 at lower pH's. For
30 example, at pH 6, gold recovery in the concentrate increases by greater than 15
percentage points for nitrogen versus air with less than a 5 percentage point increase in
sulfide sulfur recovery. These results further indicate that the refractory gold is primarily

WO 98/17395

PCT/US97/18958

associated with sulfide mineral types that are particularly difficult to recover in a concentrate using conventional flotation with air as a flotation gas. These difficult-to-float sulfide mineral types float extremely well, however, with the use of nitrogen, especially when a lead-containing activator is used at an advantageously acidic pH.

- 5 These results, especially at pH's below about 6, are particularly surprising.

Table 7

Example	Grind		Flotation	
	Atmosphere	P-80 size (microns)	Flotation Gas	pH
9	nitrogen	62	nitrogen	3
10	nitrogen	62	nitrogen	4
11	nitrogen	60	nitrogen	5
12	nitrogen	60	nitrogen	6
13	nitrogen	60	nitrogen	7
14	nitrogen	60	nitrogen	8
15	nitrogen	60	nitrogen	9
16	nitrogen	60	nitrogen	10
17	nitrogen	60	nitrogen	11
18	air	60	air	3
19	air	60	air	6
20	air	60	air	8
21	air	60	air	9
22	air	60	air	10
23	air	60	air	11
24	nitrogen	64	nitrogen	4
25	nitrogen	64	nitrogen	5
26	nitrogen	64	nitrogen	6
27	nitrogen	64	nitrogen	7
28	nitrogen	64	nitrogen	8

Table 8

Example	Reagents (lb/ton)									
	Sodium Silicate	MIBC ⁽¹⁾	DF250 ⁽²⁾	Sulfuric Acid	Calcium Hydroxide	PAX ⁽³⁾	Lead Nitrate	Copper Sulfate		
9	0.1	0.14	0.24	8.86	0	0.5	0.2	0		
10	0.1	0.12	0.27	4.22	0	0.5	0.2	0		
5 11	0.1	0.14	0.25	2.1	0	0.5	0.2	0		
12	0.1	0.14	0.2	1.3	0	0.5	0.2	0		
13	0.1	0.1	0.1	0	0.27	0.5	0.2	0		
14	0.1	0.12	0.15	0	2.49	0.5	0.2	0		
15	0.1	0.11	0.11	0	3.24	0.5	0.2	0		
16	0.1	0.1	0.07	0	3.96	0.5	0.2	0		
17	0.1	0.11	0.11	0	5.56	0.5	0.2	0		
18	0.1	0.2	0.21	6.56	0	0.5	0.2	0		
19	0.1	0.15	0.16	0	1.16	0.5	0.2	0		
20	0.1	0.15	0.13	0	2.84	0.5	0.2	0		
15 21	0.1	0.15	0.14	0	3.44	0.5	0.2	0		
22	0.1	0.16	0.14	0	4.54	0.5	0.2	0		

Example	Reagents (lb/ton)									
	Sodium Silicate	MIBC ⁽¹⁾	DF250 ⁽²⁾	Sulfuric Acid	Calcium Hydroxide	PAX ⁽³⁾	Lead Nitrate	Copper Sulfate		
23	0.1	0.15	0.13	0	5.82	0.5	0.2	0		
24	0.1	0.20	0.20	4.15	0	0.5	0	0.2		
25	0.1	0.19	0.19	2.17	0	0.5	0	0.2		
26	0.1	0.18	0.18	0.85	0	0.5	0	0.2		
5 27	0.1	0.16	0.13	0	0.3	0.5	0	0.2		
28	0.1	0.18	0.11	0	2.34	0.5	0	0.2		

(1) Methyl isobutyl carbanol

(2) Polyethylene glycol

(3) Potassium amyl xanthate

Table 9

Example	Recovery in Concentrate	
	Gold (%)	Sulfide Sulfur (%)
9	86.7	96.8
10	86.7	95.3
11	85	97.3
12	86	97.3
13	82.6	97.5
14	81.1	95
15	76.5	95.9
16	67.7	88.6
17	30.8	67.7
18	77.7	93.9
19	70.1	94
20	63.8	88.2
21	65.2	89.2
22	65.8	89.4
23	59.6	88.1
24	84.8	96.3
25	81.6	96.9
26	77.8	96.7
27	82.4	96.4
28	70.8	90.4

Examples 29-35

This example demonstrates the importance of the choice of collector reagent in performing the flotation of the present invention.

Laboratory flotation tests are performed on samples of Twin Creeks low grade gold-bearing refractory sulfide ore at a pH of from about pH 5 to about pH 6 using

various collector reagents in cost equivalent amounts. A list of the different collector reagents, companies that supply the reagents and the amount of each collector reagent used are shown in Table 10. Nitrogen gas is used in the grind and as the flotation gas. Particles are sized at a P80 size of about 46 microns and flotation is conducted in a slurry with 30% solids. The ore samples are of a low grade gold-bearing refractory sulfide ore having about 0.072 ounces per ton of gold and about 5.58 weight percent sulfide sulfur. Other reagents used during the flotation tests are shown in Table 11.

Results of the flotation tests are shown in Figs. 21 and 22, which plot percent gold recovery in the concentrate versus flotation time for the various collector reagents. As shown in Figs. 21 and 22, potassium amyl xanthate performs anomalously better than the other collectors with the flotation of the present invention.

Table 10

Example	Collector	Source	Amount lb/ton
29	PAX ⁽¹⁾	Kerly Mining, Inc.	0.50
30	S-703 ⁽²⁾	Minerals Reagents Inc.	0.14
31	AP-5100 ⁽³⁾	Cytec Industries, Inc.	0.17
32	AP-412 ⁽⁴⁾	Cytec Industries, Inc.	0.30
33	AP-3477 ⁽⁵⁾	Cytec Industries, Inc.	0.50
34	CO-200 ⁽⁶⁾	Phillips 66 Company	0.18
35	Minerec A ⁽⁷⁾	Minerec Mining Chemicals	0.17

(1) potassium amyl xanthate

(2) ethyl octyl sulfide, dialkyl dithiophosphate, polyglycol alkyl ether

(3) alkyl thionocarbonate

(4) Na-mercapto-benzothiazole and Na-di-iso-amyl dithiophosphate

(5) Na di-iso butyl dithiophosphate

(6) t-dodecyl mercaptan

(7) xanthogen formate

Table 11

Example	Other Reagents (lb/ton)				
	Sulfuric Acid	MIBC	DF250	Lead Nitrate	Sodium Silicate
29	7.76	0.12	0.25	0.3	1.0
30	4.8	0.11	0.07	0.3	1.0
31	4.37	0.07	0.07	0.3	1.0
32	5.0	0.09	0.09	0.3	1.0
33	5.04	0.04	0.04	0.3	1.0
34	5.74	0.17	0.17	0.3	1.0
35	5.49	0.11	0.11	0.3	1.0

10 Example 36

This example demonstrates the importance of grind media on operation of the flotation of the present invention.

15 Laboratory flotation is conducted on Lone Tree low grade gold-bearing refractory sulfide ore samples using nitrogen during the grind and during flotation as the flotation gas. All samples were ground to a P80 size of about 44 microns. One sample is comminuted using stainless steel rods while the other sample is comminuted using conventional mild steel balls.

20 Results of the flotation are shown graphically in Fig. 23, which includes a plot of percent gold recovery versus flotation time for each sample and a plot of oxidation reduction potential versus flotation time for each sample. As shown in Fig. 23, the sample milled with stainless steel rods exhibits substantially higher gold recovery at all flotation times. More importantly, a high gold recovery is achieved in a much shorter flotation time for the sample milled with the stainless steel rods than for the sample milled with the mild steel balls. This distinction is significant because it indicates that
25 flotation times may be reduced with the use of stainless steel or other comminution media, such as a high chromium alloy hardened steel, that would introduce less reactive iron into the flotation system.

Example 37

This example demonstrates a surprising effect of performing a magnetic separation on a ore sample prior to flotation according to the present invention.

5 Samples of Lone Tree subgrade gold-bearing refractory sulfide ore are subjected to laboratory flotation. Both samples are comminuted to a P80 size of approximately 270 mesh. Following comminution, one sample is subjected to magnetic separation to remove magnetic iron particles prior to flotation while the other sample is not.

10 Results are shown graphically in Fig. 24, which includes a plot of percent gold recovery in the flotation concentrate versus flotation time and a plot of oxidation-reduction potential in the flotation slurry versus flotation time. As seen in Fig. 24, gold recovery is significantly higher for the sample subjected to the magnetic separation. The effect is particularly pronounced at shorter flotation times, but even after 30 minutes of flotation, the sample having been subjected to magnetic separation exhibits gold recovery that is approximately ten percentage points higher than the sample with no magnetic
15 separation.

Example 38

This example demonstrates the important effect with the present invention of using deoxygenated process water.

20 Samples of a Twin Creeks low grade gold-bearing refractory sulfide ore are subjected to laboratory flotation. Samples contain about 0.072 ounces per ton of gold and about 5.58 weight percent of sulfide sulfur. Grinding is performed in a nitrogen atmosphere for each sample and flotation is performed using nitrogen as the flotation gas. Both samples are sized at a P80 size of about 46 microns. One sample is slurried with regular tap water for the flotation. The other sample is slurried with tap water that has
25 been deoxygenated by bubbling nitrogen gas through the water for a sufficient time to remove most of the oxygen previously dissolved in the water.

Results of flotation for each sample are shown in Figs. 25-27. Fig. 25 includes a plot of weight recovery in the concentrate versus flotation time for each sample, and shows that flotation with the deoxygenated water attains a greater weight recovery in the
30 flotation concentrate. Fig. 26 includes a plot of gold recovery in the concentrate versus flotation time for each sample, and shows that at the longer flotation times, gold recovery

is higher using the deoxygenated water. Fig. 27 includes a plot of sulfide sulfur recovery in the concentrate versus flotation time, and shows that, at longer flotation times, sulfide sulfur recovery in the concentrate is higher using the deoxygenated water. The increased gold and sulfide sulfur recoveries indicate a significantly higher recovery of refractory
5 auriferous sulfides in the concentrate.

Examples 39-57

These examples demonstrate the benefit of a tail leach with the present invention.

Samples of Lone Tree subgrade gold-bearing refractory sulfide ore are subjected to laboratory flotation. Each sample is ground to a P80 size of approximately 270 mesh
10 in a nitrogen atmosphere. Flotation is conducted with a nitrogen flotation gas. Following flotation for each sample, the flotation tail is subjected to a carbon-in-leach cyanidation to recover gold remaining in the flotation tail.

Results are shown in Table 12, where it is seen that the leach of the flotation tail significantly contributes to gold recovery according to the process of the present
15 invention.

Table 12

Example	Gold Recovery ⁽¹⁾ From Flotation Concentrate	Gold Recovery from Flotation Tail	Total Gold Recovery
39	87.3	5.7	93.0
40	81.6	9.1	90.7
41	72.9	10.3	83.2
42	75.6	11.4	87.0
43	79.0	9.2	88.2
44	74.5	12.3	86.8
45	75.5	12.8	88.3
46	79.9	8.9	88.8
47	82.4	4.3	86.7
48	83.6	9.8	93.4
49	85.5	5.4	90.9
50	85.6	4.6	90.2
51	87.9	3.9	91.8
52	78.8	3.5	82.3
53	78.4	5.8	84.2
54	84.4	1.5	85.9
55	76.6	6.1	82.7
56	87.1	5.4	92.5
57	80.7	4.0	84.7

(1) Assumes 96% of gold in concentrate removed in CIL leach following pressure oxidation.

The present invention has been described with reference to specific embodiments of the present invention. According to the present invention, however, any of the features shown in any embodiment may be combined in any way with any other feature of any other embodiment. For example, any feature shown in any one of Figs. 1-3, 8, 10-17 and 28 can be combined with any other feature shown in any of those figures. Furthermore,

WO 98/17395**PCT/US97/18958**

while various embodiments of the present invention have been described in detail, it is apparent that modifications and adaptations to those embodiments will occur to those skilled in the art. It is to be expressly understood that such modifications and adaptations are within the scope of the present invention, set forth in the following claims.

What is claimed is:

1. A method for flotation processing of a gold-bearing mineral material feed containing a plurality of different sulfide mineral species, including one or more refractory auriferous sulfide containing gold that is refractory due to its presence in the refractory auriferous sulfide, the method comprising the steps of:

subjecting to flotation in a liquid medium said mineral material feed in particulate form, said flotation including passing bubbles of a flotation gas through said liquid medium;

during said flotation, a first portion of said mineral material feed rising through said liquid medium with said bubbles and said first portion being collected from a flotation froth as a flotation concentrate, a second portion of said mineral material feed being collected as a flotation tail;

said flotation concentrate being enriched, relative to said mineral material feed, in each of said plurality of different sulfide mineral species, including said one or more refractory auriferous sulfide, and in gold;

said flotation tail being depleted, relative to said mineral material feed, in each of said plurality of different sulfide mineral species, including said one or more refractory auriferous sulfide, and in gold;

wherein, said flotation gas is free of oxygen gas or comprises oxygen gas at a volume fraction of oxygen gas that is smaller than the volume fraction of oxygen gas in ambient air, and wherein the flotation is substantially not selective as between said plurality of different sulfide mineral species.

2. The method of claim 1, wherein:

said flotation gas comprises less than about 10 volume percent oxygen gas.

3. The method of claim 1, wherein:

5 said flotation gas comprises less than about 5 volume percent oxygen gas.

4. The method of claim 1, wherein:

said flotation gas comprises greater than about 95 volume percent of gas
selected from the group consisting of nitrogen gas, carbon dioxide gas, helium gas,
10 argon gas and combinations thereof.

5. The method of claim 1, wherein:

said flotation gas comprises combustion exhaust.

15 6. The method of claim 1, wherein:

said plurality of different sulfide mineral species comprise a plurality of
different iron-containing sulfide mineral species and said flotation is substantially not
selective to flotation of said different iron-containing sulfide mineral species, so that
said flotation concentrate is enriched, relative to said mineral material feed, in each of
20 said plurality of different iron-containing sulfide mineral species.

7. The method of claim 1, wherein:

after said flotation, said flotation tail is subjected to leaching to remove from
said flotation tail non-refractory gold that is not associated with a sulfide mineral.

8. The method of claim 7, wherein:

said leaching comprises cyanide leaching of gold from said flotation tail.

5 9. The method of claim 1, wherein:

said liquid medium comprises deoxygenated water.

10. The method of claim 9, wherein:

10 said deoxygenated water comprises less than about 2.0 parts per million by weight of oxygen.

11. The method of claim 9, wherein:

said deoxygenated water, prior to said flotation, had been prepared by passing a gas through water to remove oxygen from said water.

15

12. The method of claim 1, wherein:

prior to said flotation, said mineral material feed is subjected to wet comminution to reduce the particle size of said mineral material;

water used during said wet comminution comprising deoxygenated water.

20

13. The method of claim 12, wherein:

said comminution is conducted in an environment that is substantially free of air.

14. The method of claim 1, wherein:

before said flotation, said mineral material feed is subjected to comminution to reduce the particle size of said mineral material feed;

5 said comminution being conducted in equipment sealed to substantially prevent air from being drawn into said equipment.

15. The method of claim 14, wherein:

said comminution comprises processing said mineral material through a sealed comminution unit having an inlet and an outlet;

10 a blanketing gas being introduced into at least one of said inlet and said outlet; said blanketing gas comprising no greater than about 5 volume percent oxygen.

16. The method of claim 15, wherein:

15 said blanketing gas comprises greater than about 95 volume percent of gas selected from the group consisting of nitrogen gas, carbon dioxide gas, helium gas, argon gas and combinations thereof.

17. The method of claim 14, wherein:

20 beginning with said comminution and ending after said flotation, said mineral material feed is processed in an environment that is substantially free of oxygen gas.

18. The method of claim 1, wherein:

before said flotation, said mineral material feed is subjected to comminution to reduce the particle size of said mineral material feed;

5 said comminution being performed in the interior of a vessel having a nonmetallic interior lining to reduce the potential for contamination of said mineral material by iron.

19. The method of claim 1, wherein:

10 before said flotation, said mineral material feed is subjected to comminution in the presence of grinding media to reduce the particle size of said mineral material;

said grinding media comprising at least one of a corrosion resistant steel and a hardened steel alloy.

20. The method of claim 19, wherein:

15 said grinding media comprises at least one of stainless steel, a chromium alloy steel and a nickel alloy steel.

21. The method of claim 1, wherein:

20 before said flotation, said mineral material feed is subjected to magnetic separation to remove particles of magnetic iron to reduce galvanic interaction involving iron during said flotation.

22. The method of claim 1, wherein:

a lead-containing activator contacts said mineral material feed during said flotation.

5 23. The method of claim 17, wherein:

said lead-containing activator comprises at least one of lead nitrate and lead acetate.

24. The method of claim 1, wherein:

10 a copper-containing activator contacts said mineral material feed during said flotation.

25. The method of claim 1, wherein:

a xanthate collector contacts said mineral material feed during said flotation.

15

26. The method of claim 1, wherein:

during said flotation, said liquid medium is at an acidic pH.

27. The method of claim 1, wherein:

20 during said flotation, said liquid medium is at a pH of smaller than about pH 6.

28. The method of claim 1, wherein:

during said flotation, said liquid medium is at a pH of from about pH 3 to about pH 6.

29. The method of claim 1, wherein:

said flotation comprises a first flotation stage of said mineral material feed to produce a first flotation concentrate enriched, relative to said mineral material feed, in sulfide species and in gold and to produce a first flotation tail depleted, relative to said mineral material feed, in said sulfide species and in gold;

said flotation further comprising a second flotation stage wherein at least a portion of said first flotation tail is subjected to further flotation to produce a second flotation concentrate enriched, relative to said first flotation tail, in said sulfide species and in gold and to produce a second flotation tail depleted, relative to said first flotation tail, in said sulfide species and in gold;

after said first flotation stage and prior to said second flotation stage, said first flotation tail being subjected to comminution to reduce the size of particles in said first flotation tail.

30. The method of claim 29, wherein:

after said comminution and prior to said second flotation stage, said first flotation tail is subjected to size separation to separate said first flotation tail into two fractions, a first fraction of smaller-size particles and a second fraction of larger-size particles, said second fraction being subjected to said second flotation stage and said first fraction not being subjected to said second flotation stage.

31. The method of claim 1, wherein:

said flotation is conducted in a sealed flotation apparatus having a vapor
headspace above said liquid medium;

5 gas is withdrawn from said vapor headspace and recycled for introduction into
said liquid medium to form at least a part of said flotation gas.

32. The method of claim 31, wherein:

said flotation apparatus comprises means for dispersing said flotation gas in said
liquid medium, said means for dispersing creating a vacuum to suck said gas from said
10 vapor headspace to introduce said gas into said liquid medium.

33. The method of claim 1, wherein:

the one or more refractory auriferous sulfide includes an arsenian pyrite.

15 34. The method of claim 1, wherein:

the one or more refractory auriferous sulfide includes an arsenian marcasite.

35. The method of claim 1, wherein:

20 the one or more refractory auriferous sulfide includes an arsenian pyrrhotite.

36. The method of claim 1, wherein:

the one or more refractory auriferous sulfide includes arsenopyrite.

37. The method of claim 1, wherein:

the one or more refractory auriferous sulfide includes an iron-containing
orpiment.

5 38. The method of claim 1, wherein:

the one or more refractory auriferous sulfide includes an iron-containing
realgar.

39. The method of claim 1, wherein:

10 the plurality of different sulfide mineral species includes, in addition to the one
or more refractory auriferous sulfide, at least one sulfide specie that is not a refractory
auriferous sulfide.

40. The method of claim 39, wherein:

15 the at least one sulfide specie includes an iron-containing sulfide.

41. The method of claim 1, wherein:

the plurality of different sulfide mineral species includes a plurality of different
pyrite species, a first pyrite specie having a morphology with a coarser grain size than a
20 second pyrite specie, which has a morphology with a finer grain size; and
the one or more refractory auriferous sulfide includes said second pyrite specie.

42. The method of claim 37, wherein:

the first pyrite specie is substantially free of gold relative to the second pyrite specie.

5 43. The method of claim 1, wherein:

the plurality of different sulfide mineral species includes a plurality of different species of refractory auriferous sulfides and at least one sulfide specie being substantially free of gold relative to each of the plurality of different species of refractory auriferous sulfides.

10

44. The method of claim 1, wherein:

the one or more refractory auriferous sulfide includes a plurality of different species of refractory auriferous sulfides, and said flotation concentrate is enriched in each of said plurality of different refractory auriferous sulfides and said flotation tail is
15 depleted in each of said plurality of refractory auriferous sulfides.

45. The method of claim 44, wherein:

the plurality of different species of refractory auriferous sulfides includes at least a plurality of different arsenian iron sulfides.

20

46. The method of claim 45, wherein:

the plurality of different arsenian iron sulfides includes a plurality of members from the group consisting of an arsenian pyrite, an arsenian marcasite and an arsenian pyrrhotite.

47. The method of claim 44, wherein:

the plurality of different species of refractory auriferous sulfides includes a plurality of members from the group consisting of an arsenian pyrite, an arsenian marcasite, an arsenian pyrrhotite, an arsenopyrite, an iron-containing orpiment and an
5 iron-containing realgar.

48. The method of claim 1, wherein:

the flotation is substantially not selective as to substantially all sulfide mineral species originally in said mineral material feed.

1/24

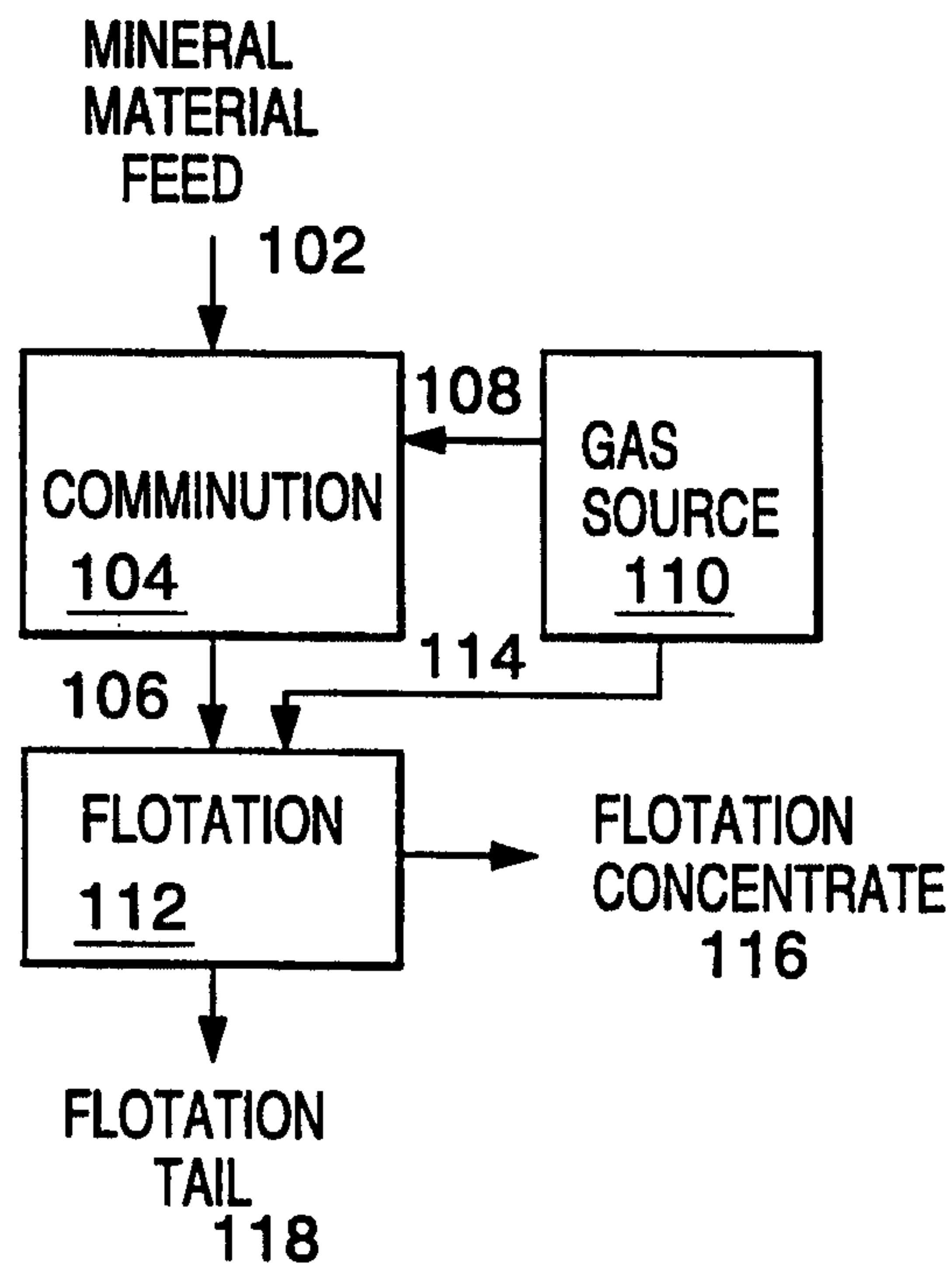

Fig. 1

2/24

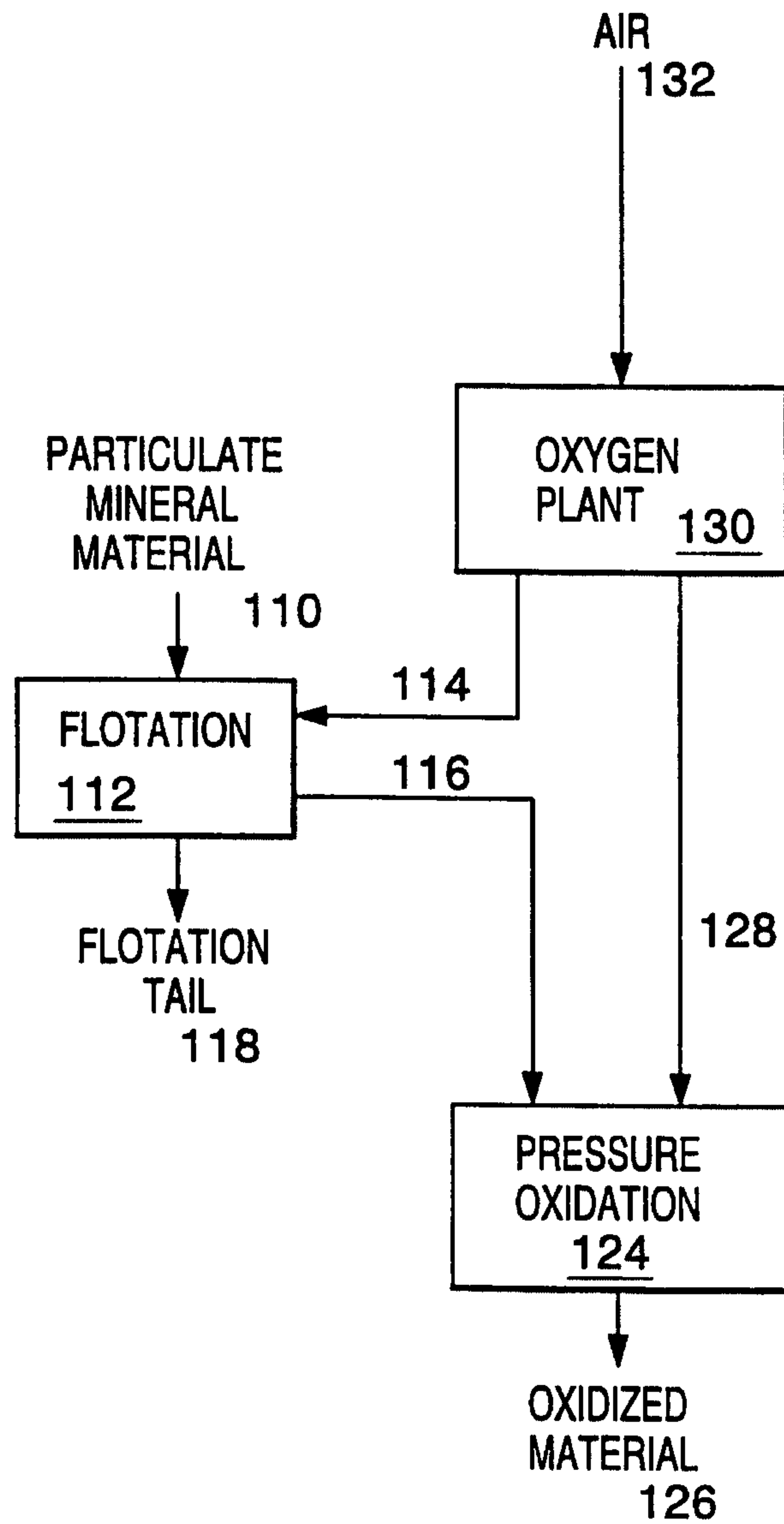

Fig. 2

3/24

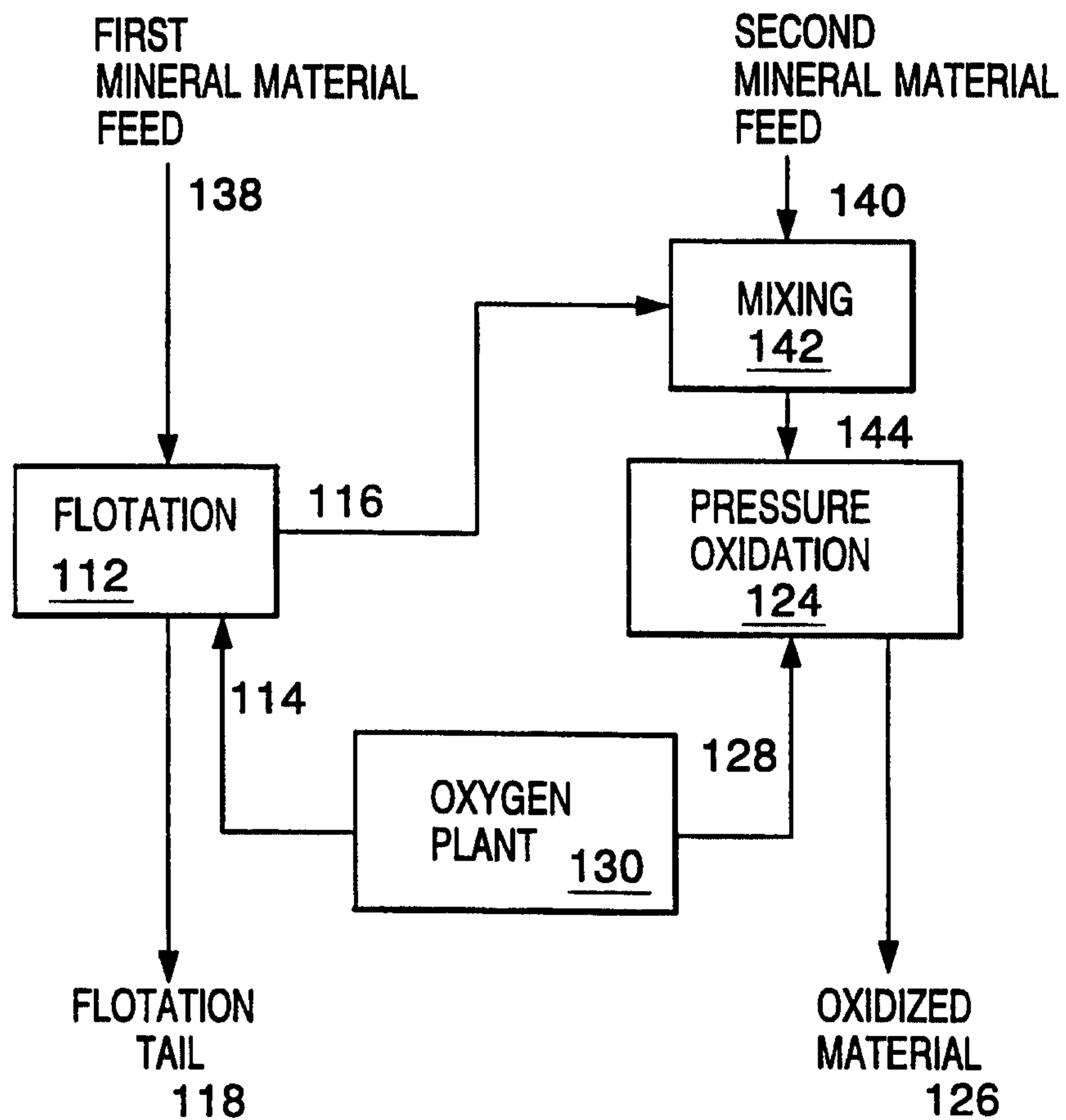

Fig. 3

4/24

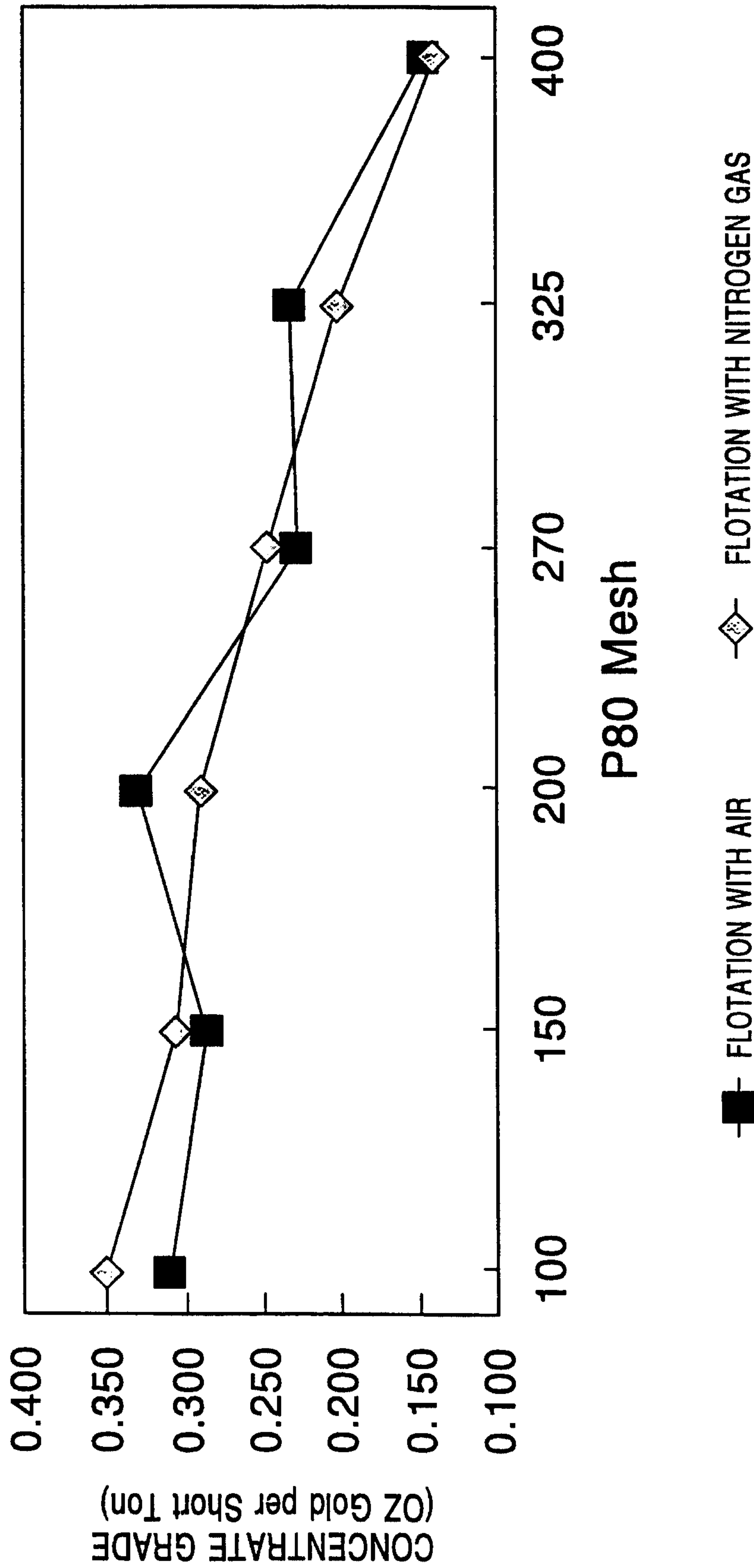

Fig. 4

5/24

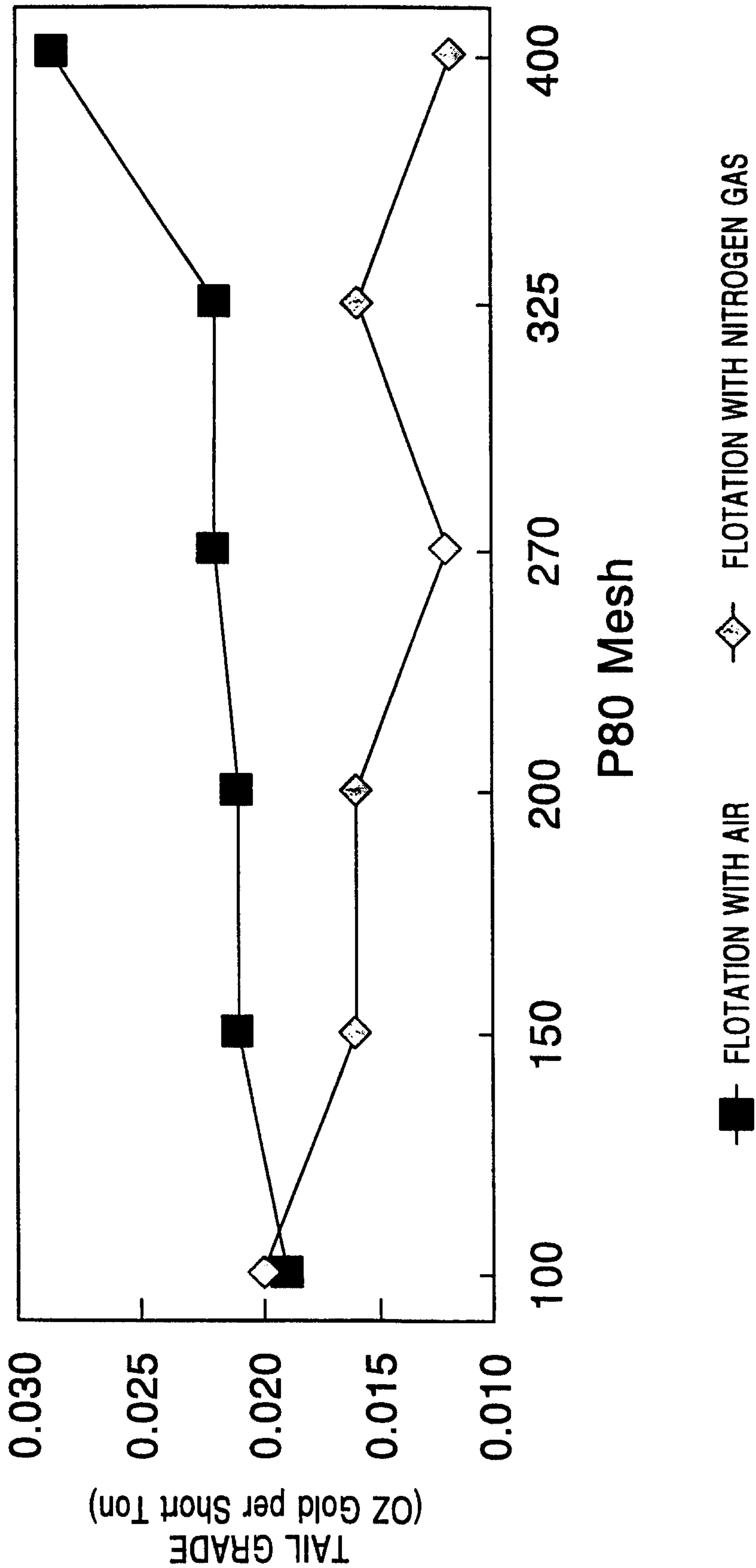

Fig. 5

6/24

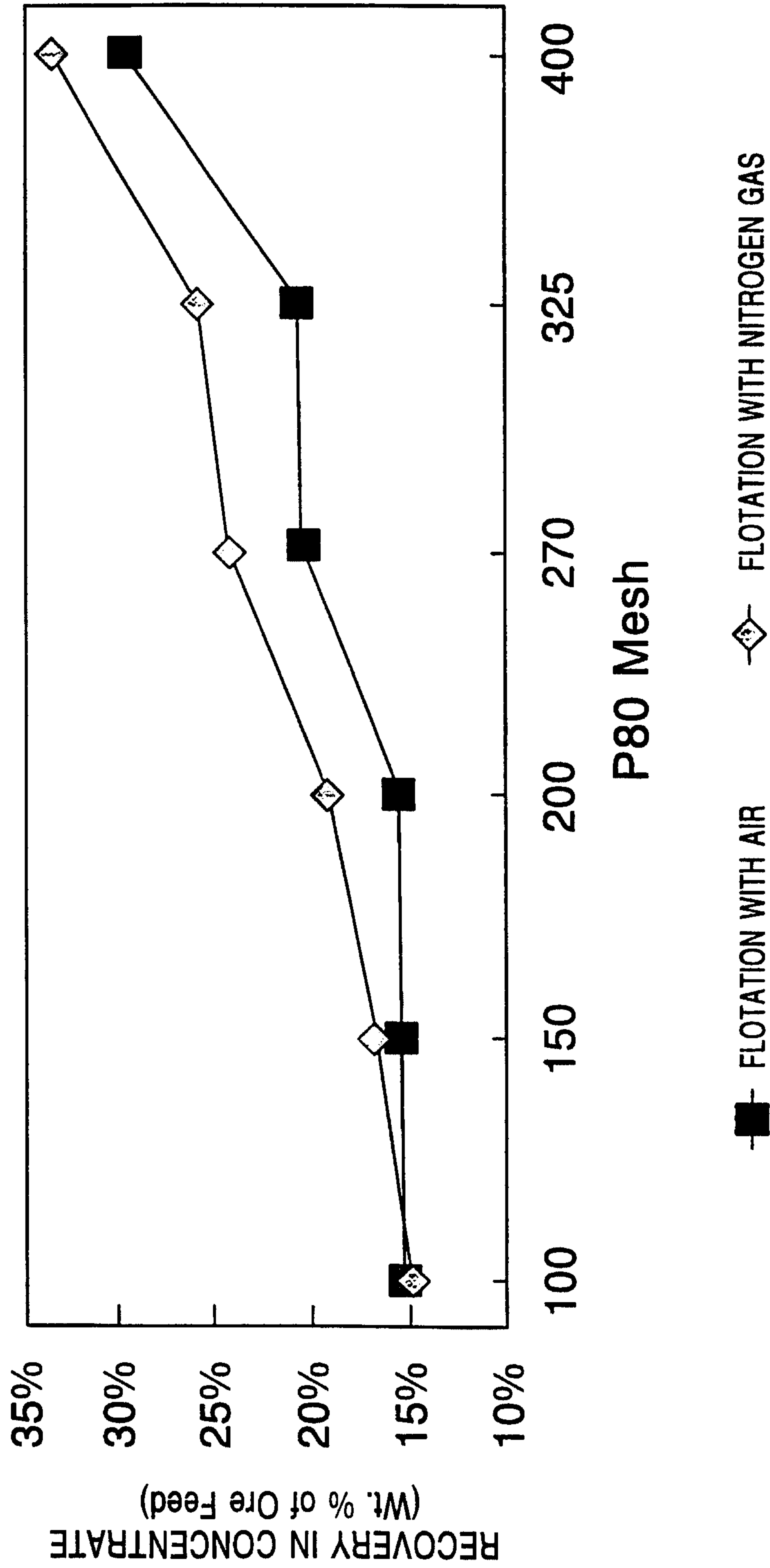

Fig. 6

7/24

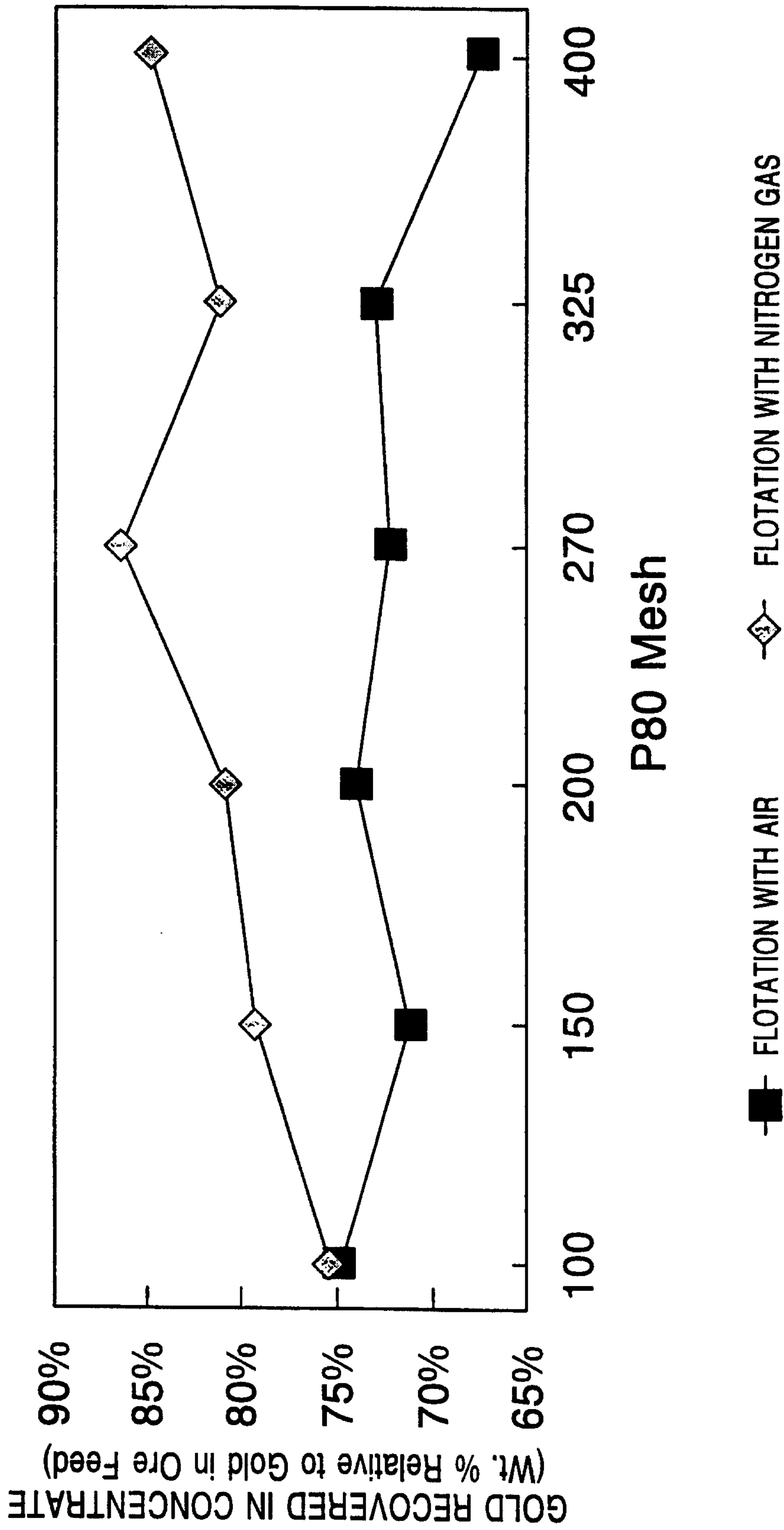

Fig. 7

8/24

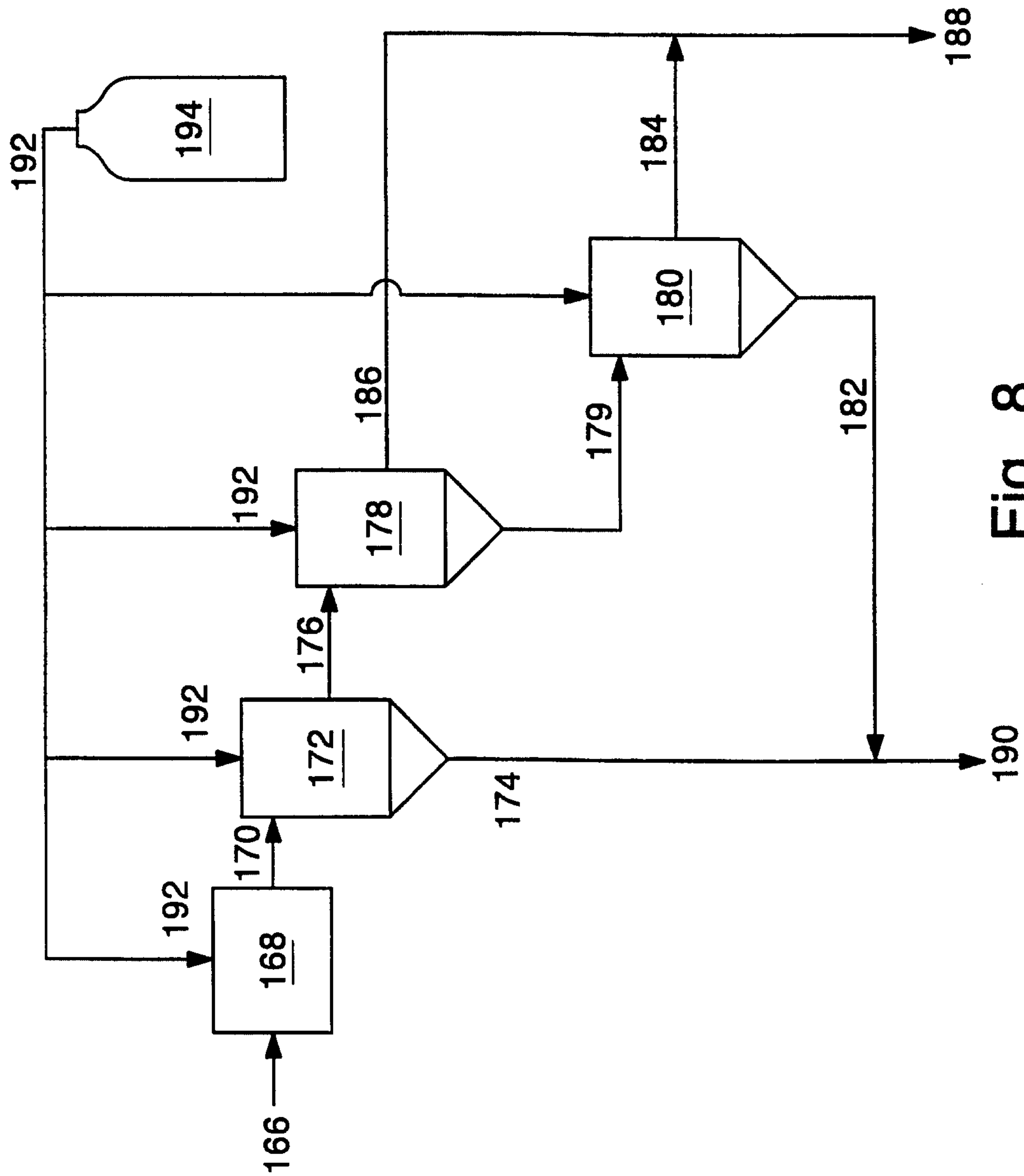

Fig. 8

9/24

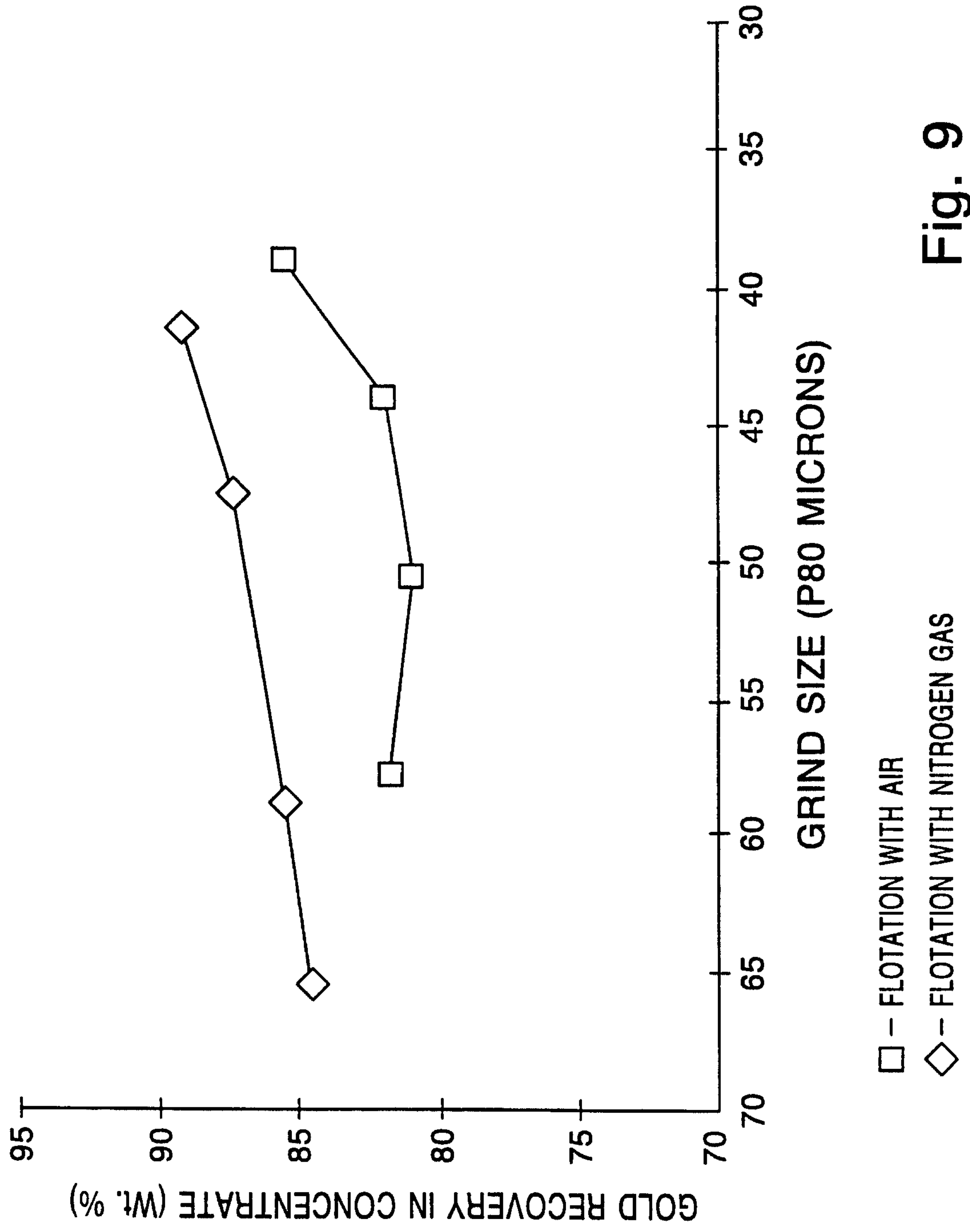
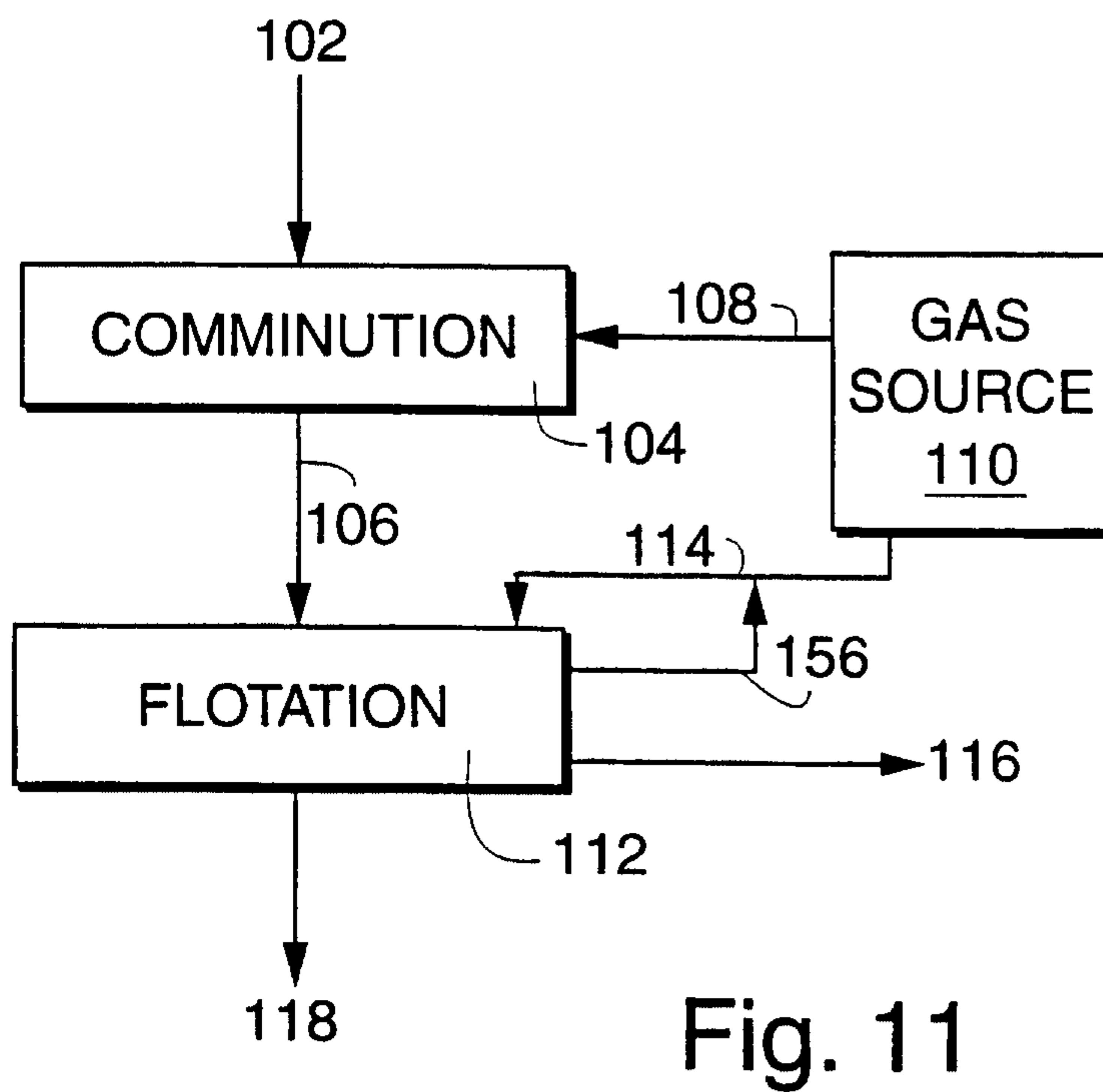
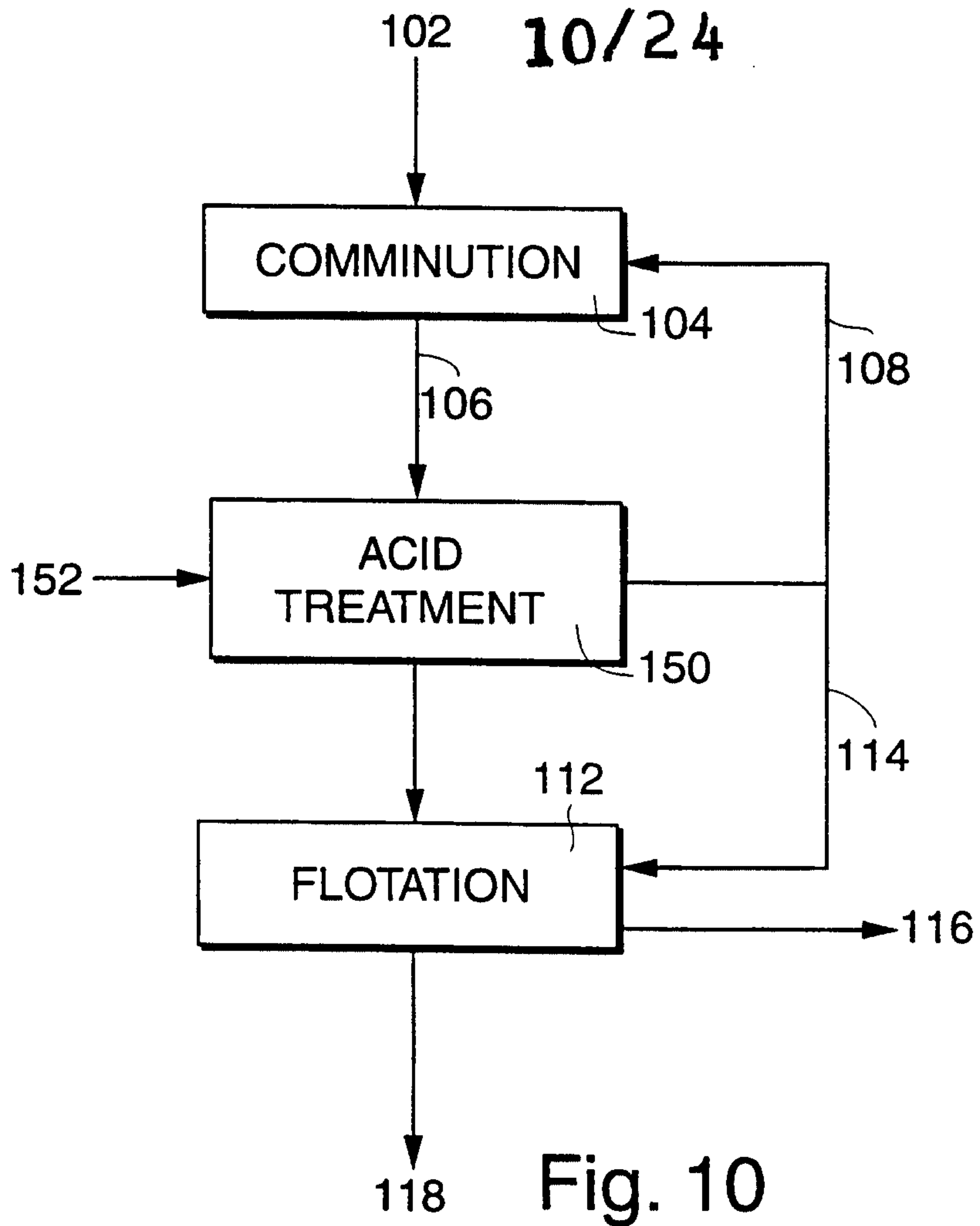

Fig. 9



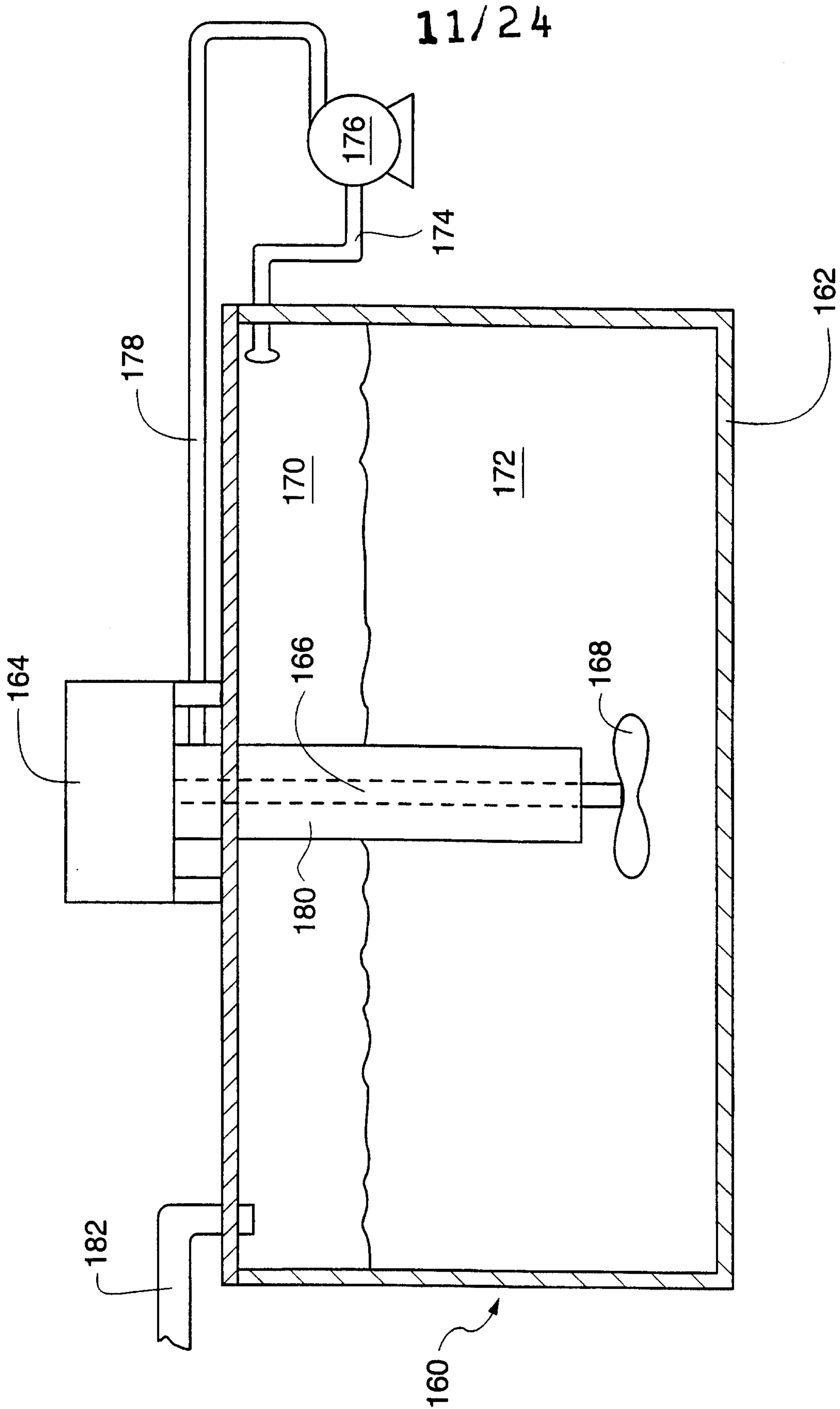

Fig. 12

12/24

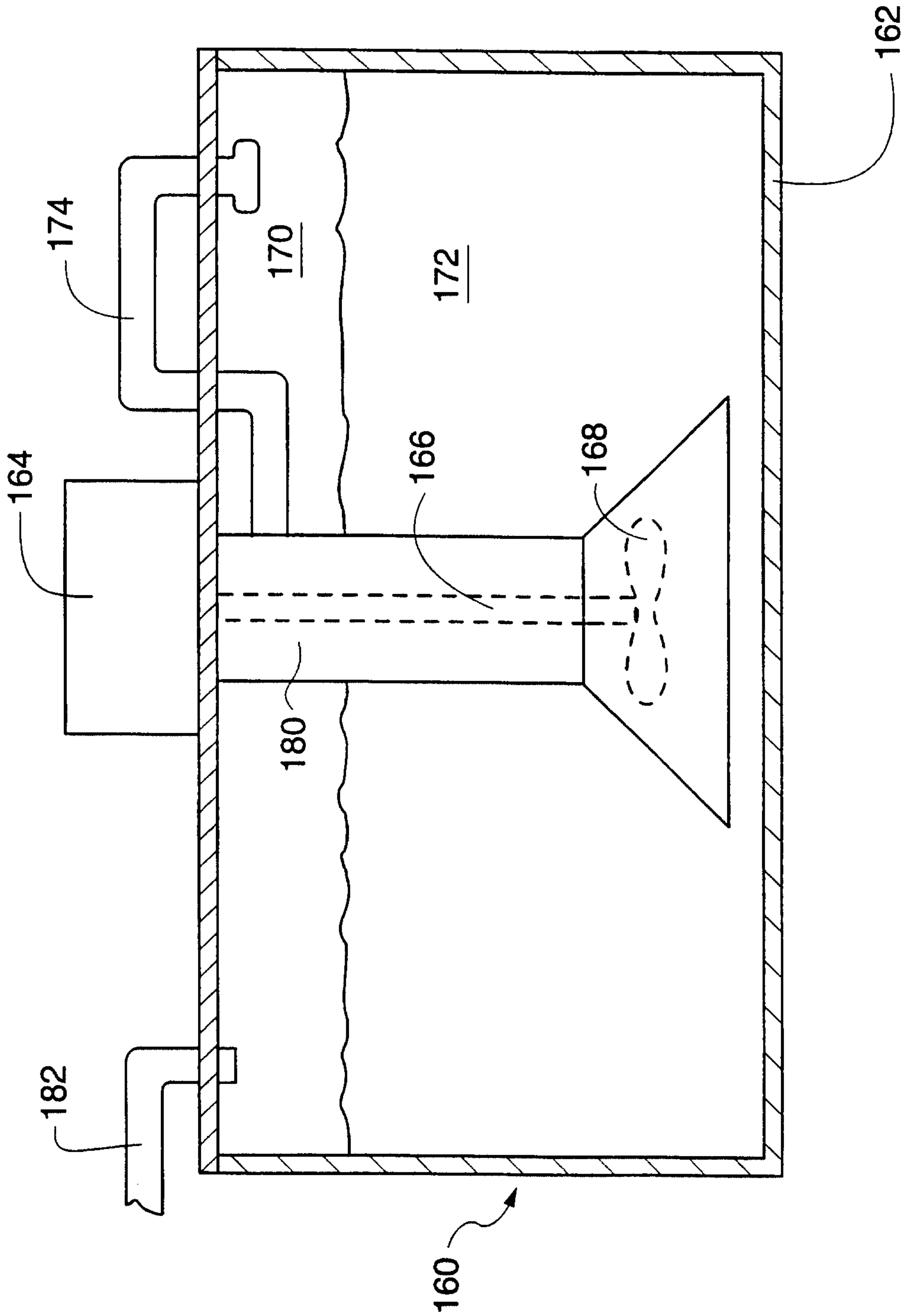

Fig. 13

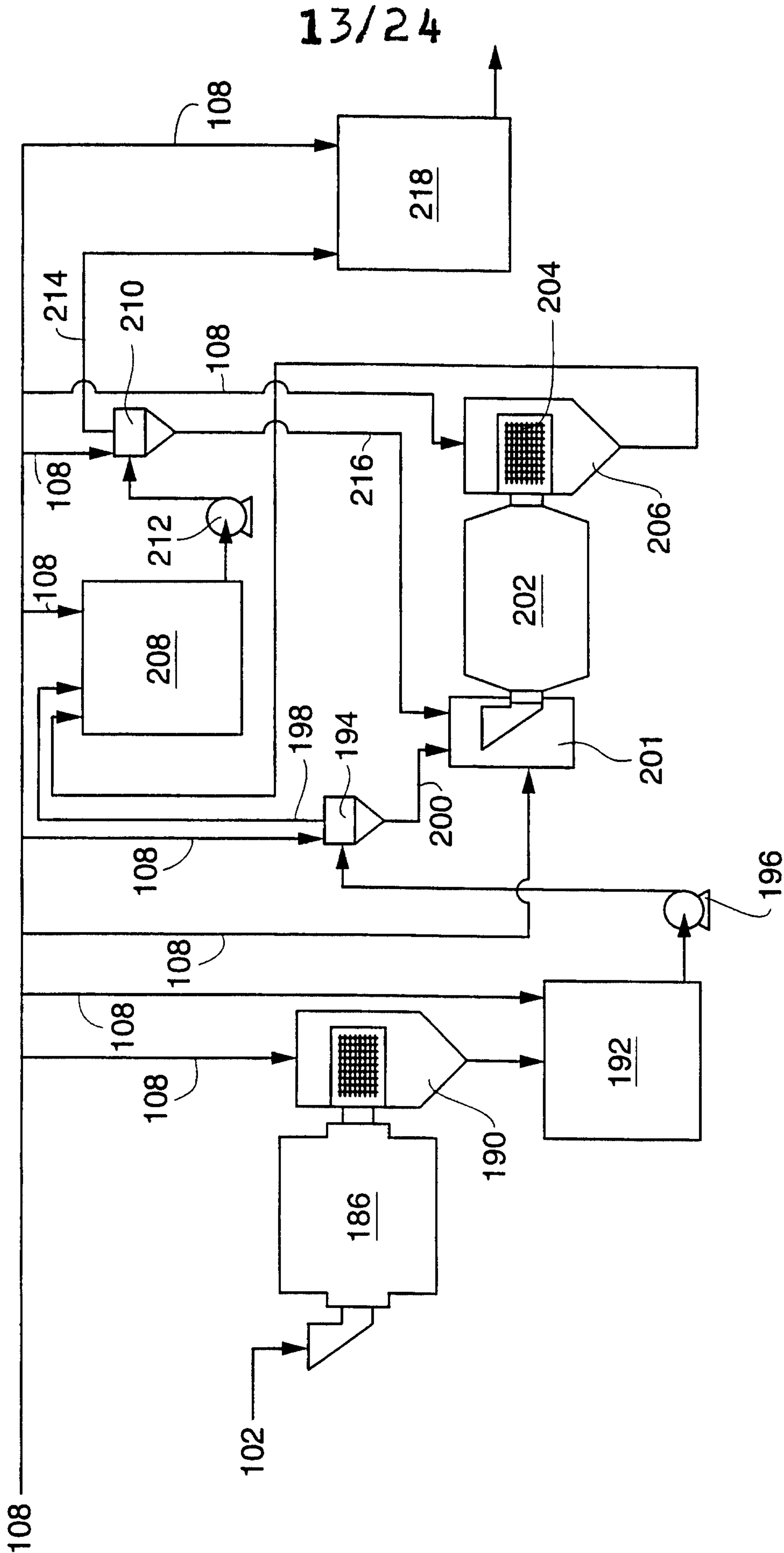

Fig. 14

14/24

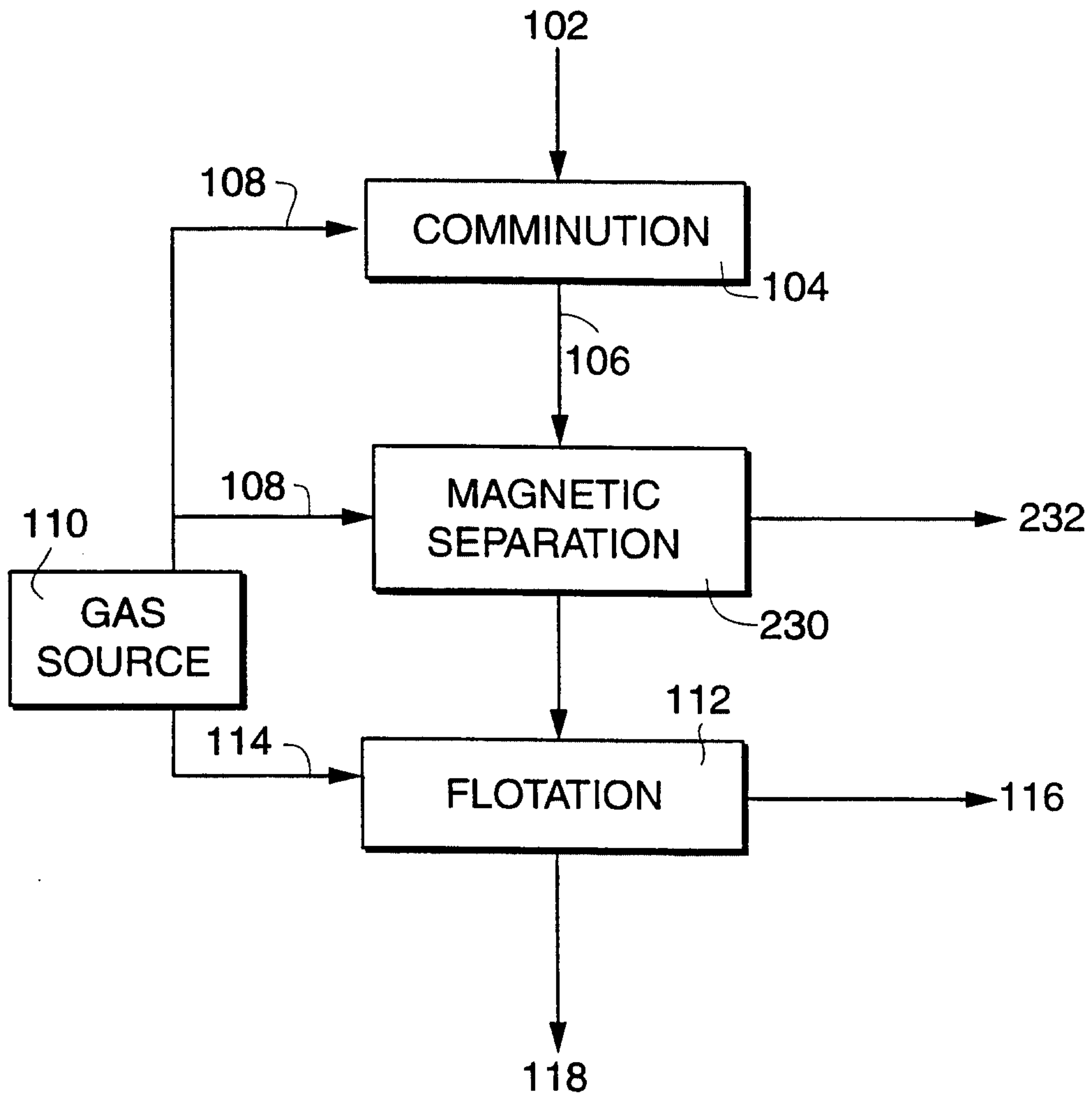

Fig. 15

15/24

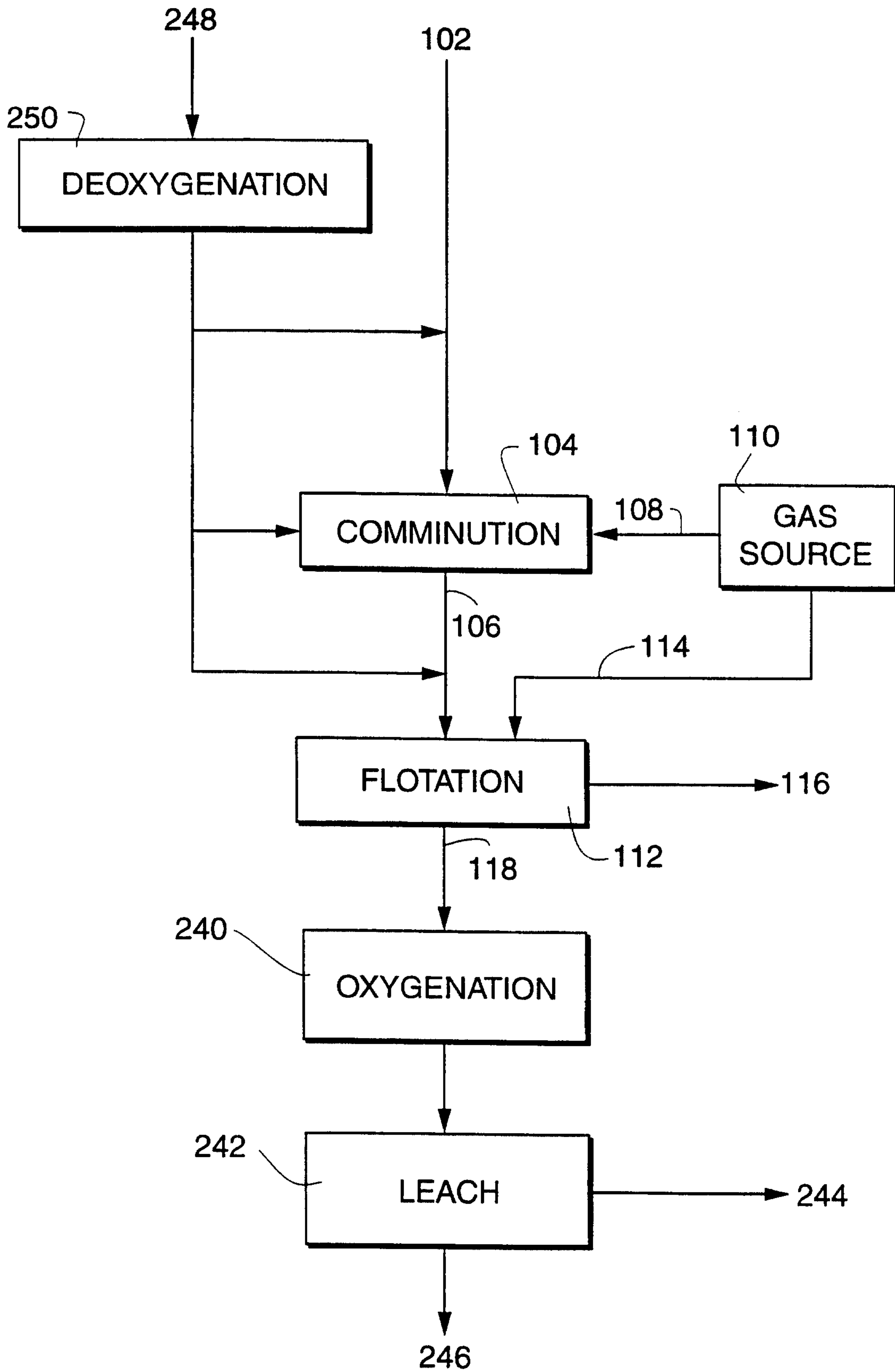

Fig. 16

16/24

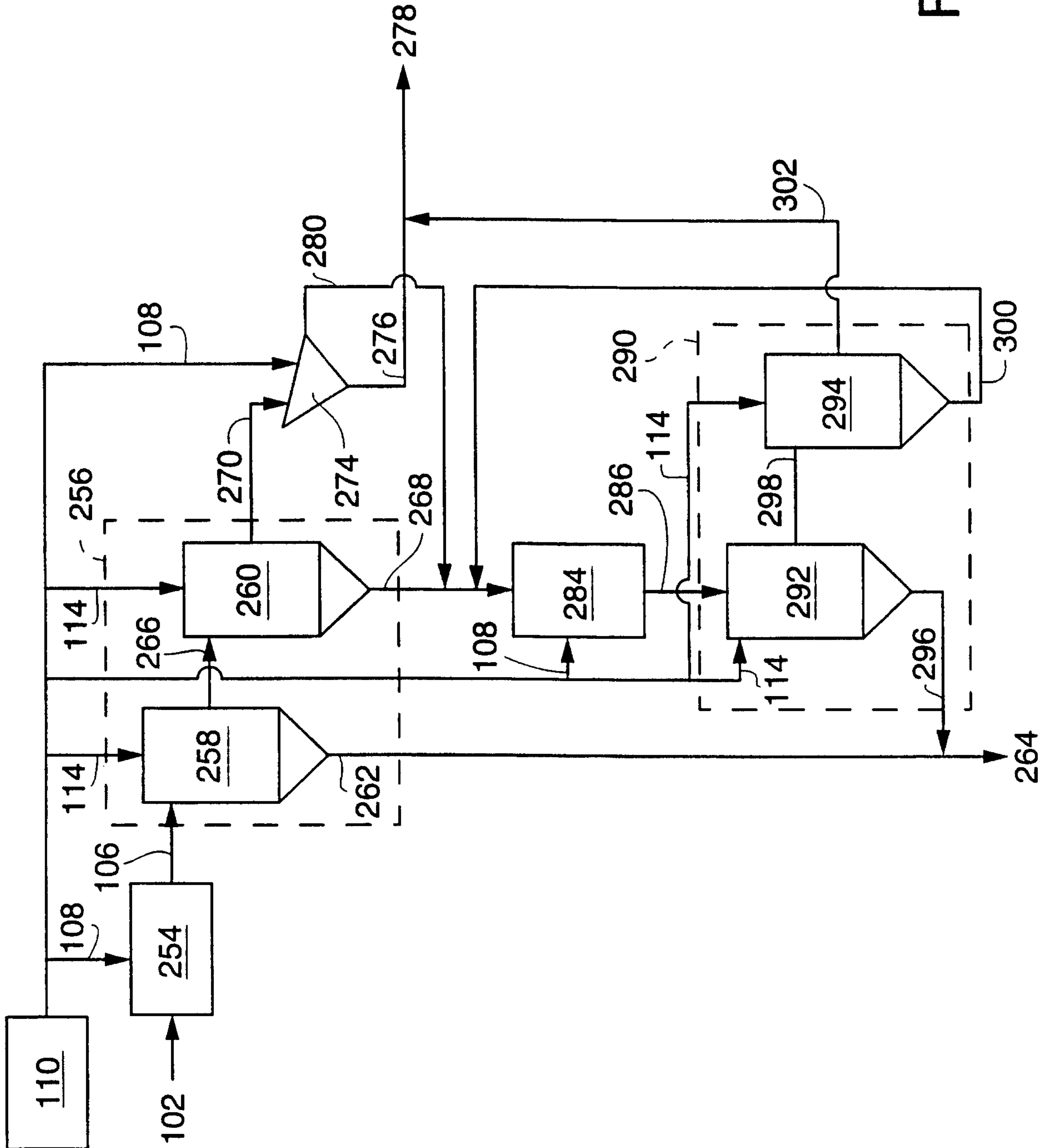

Fig. 17

17/24

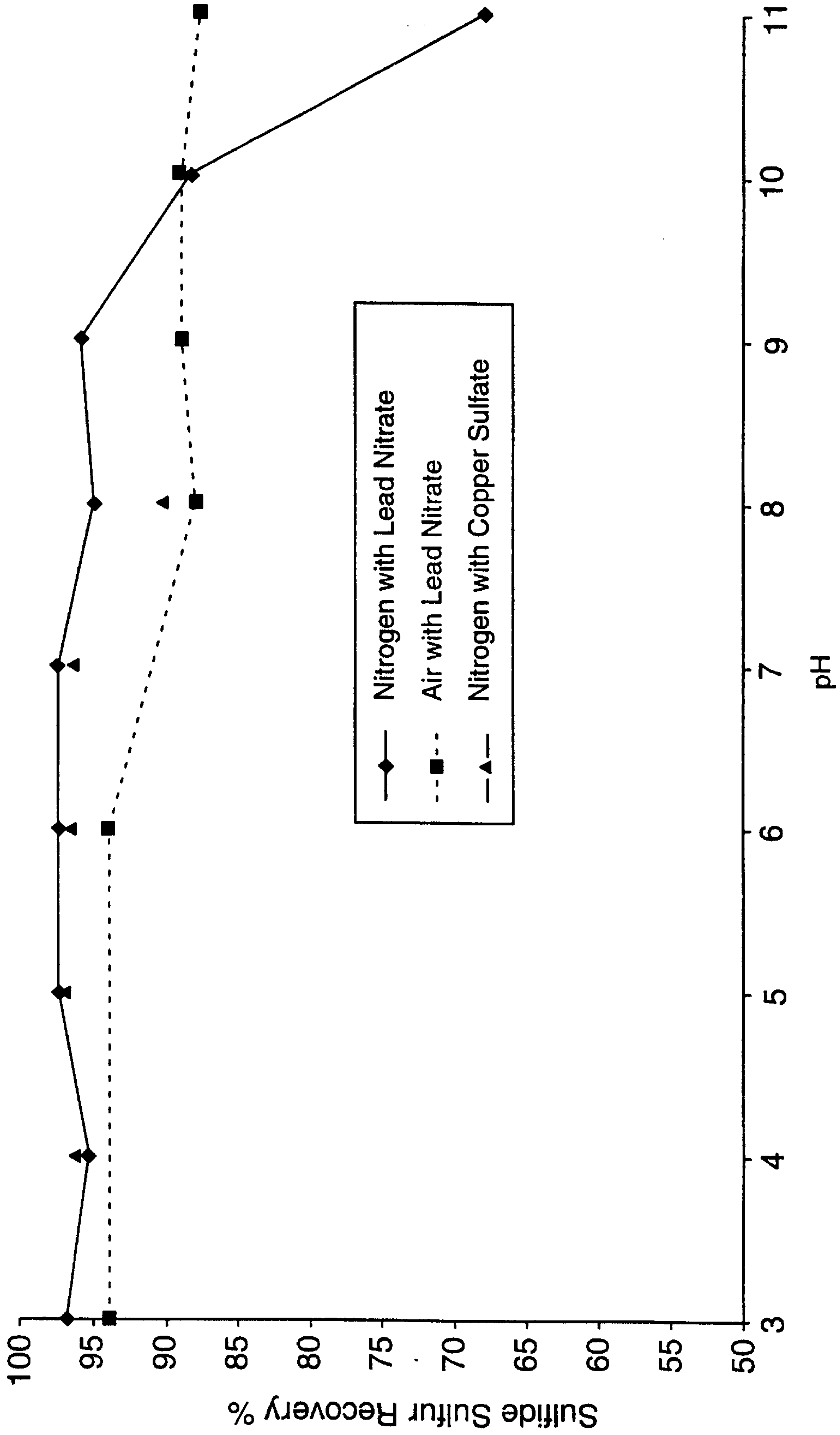

Fig. 18

18/24

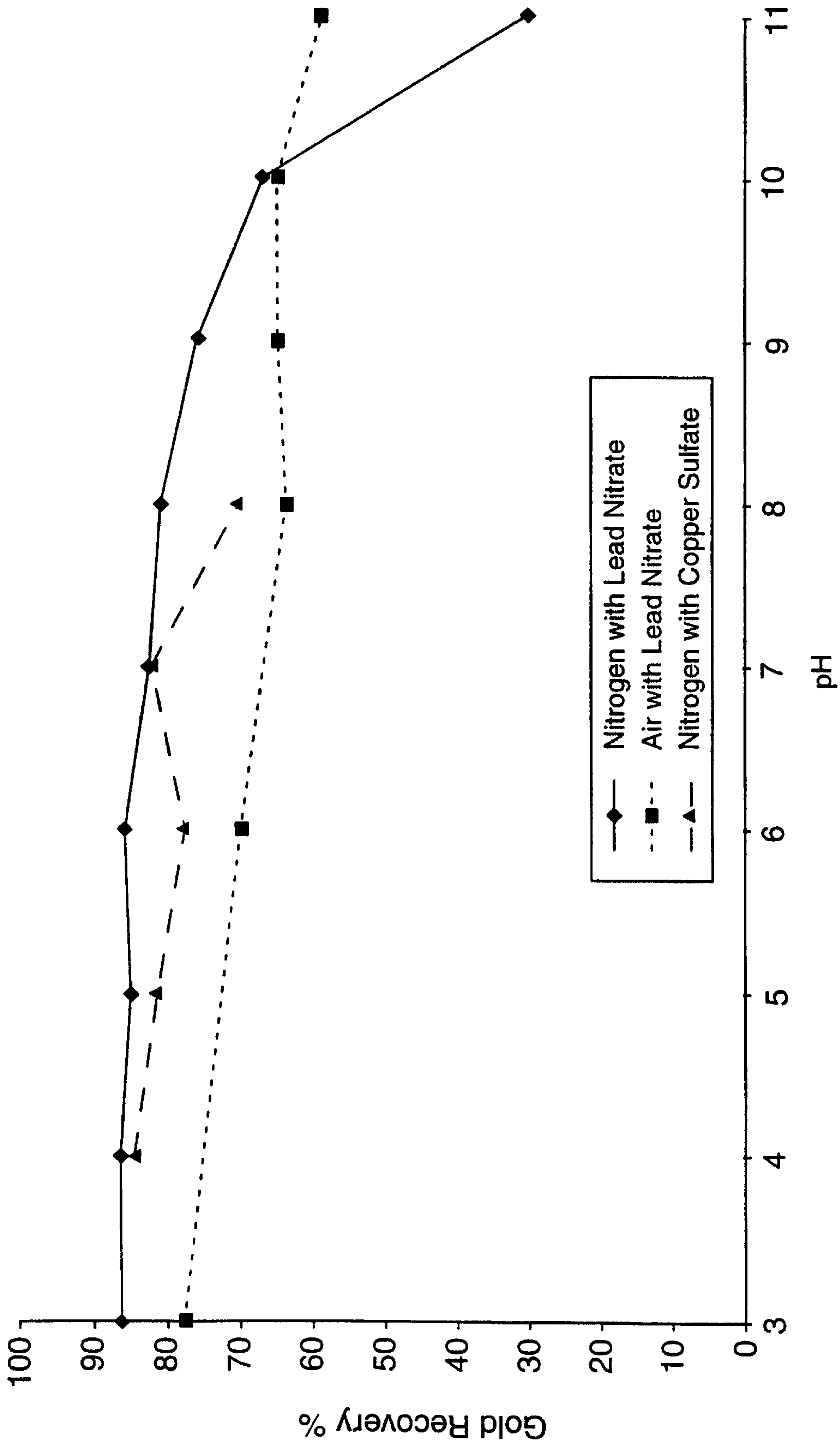

Fig. 19

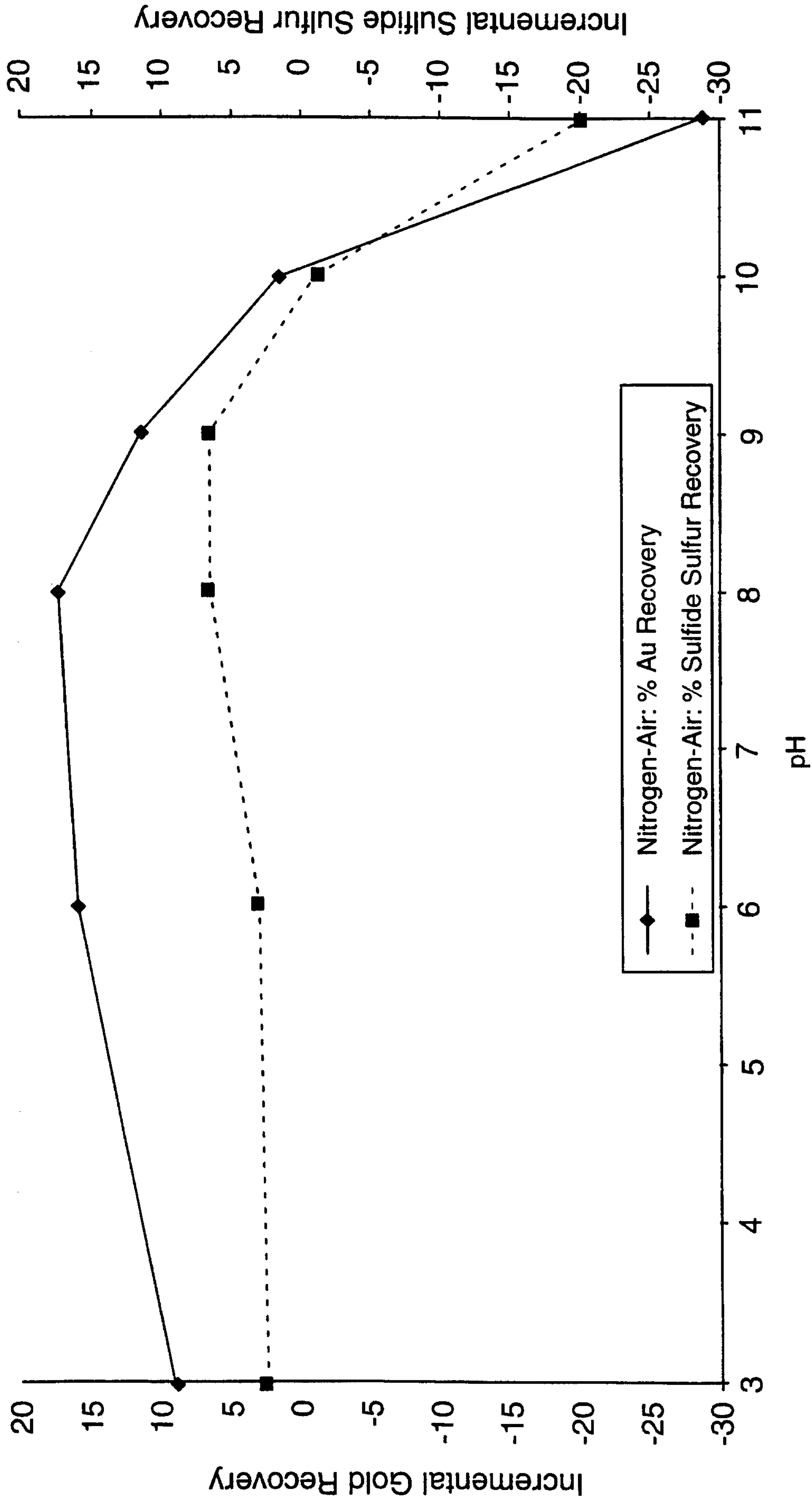

Fig. 20

20/24

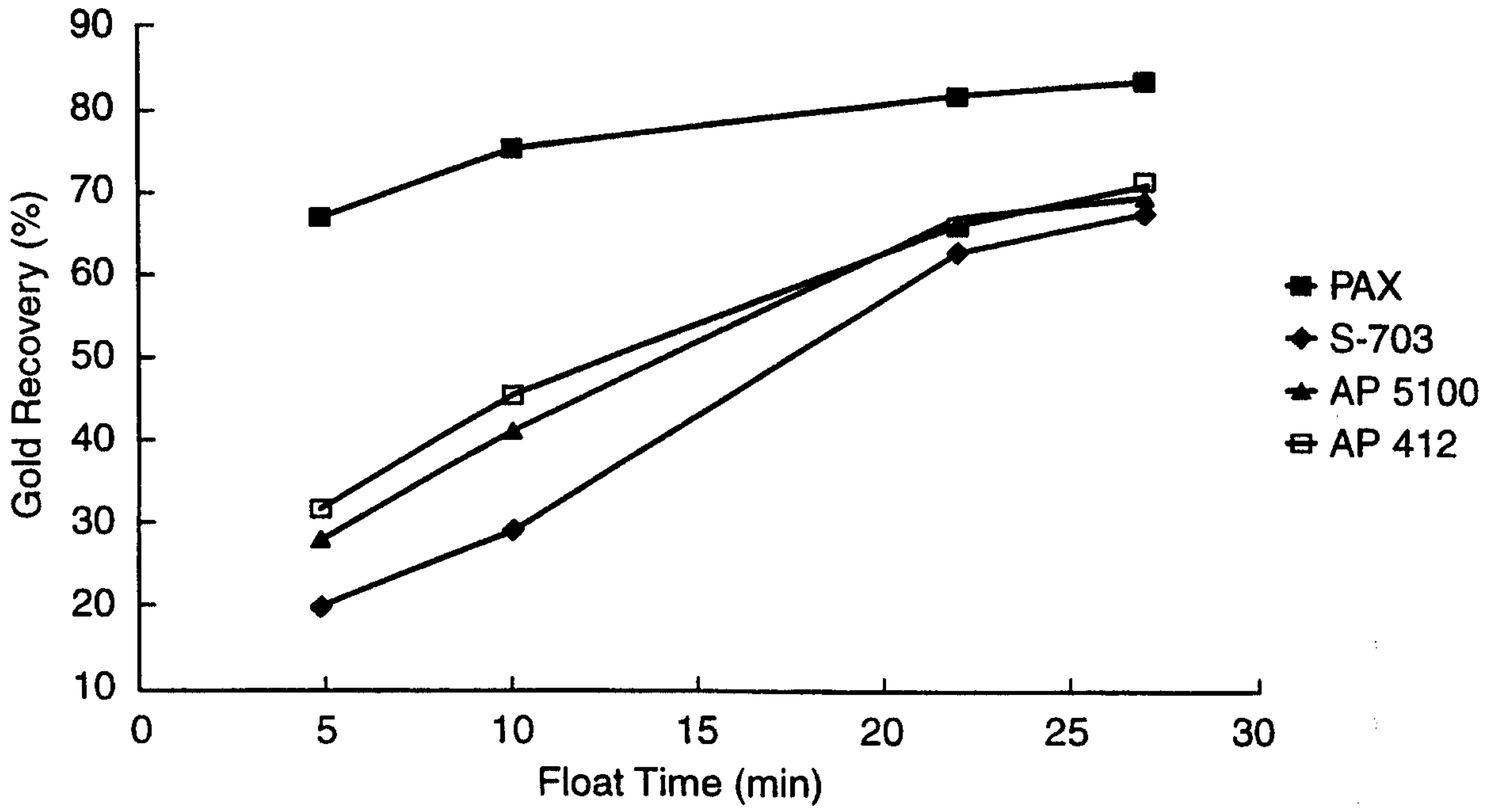

Fig. 21

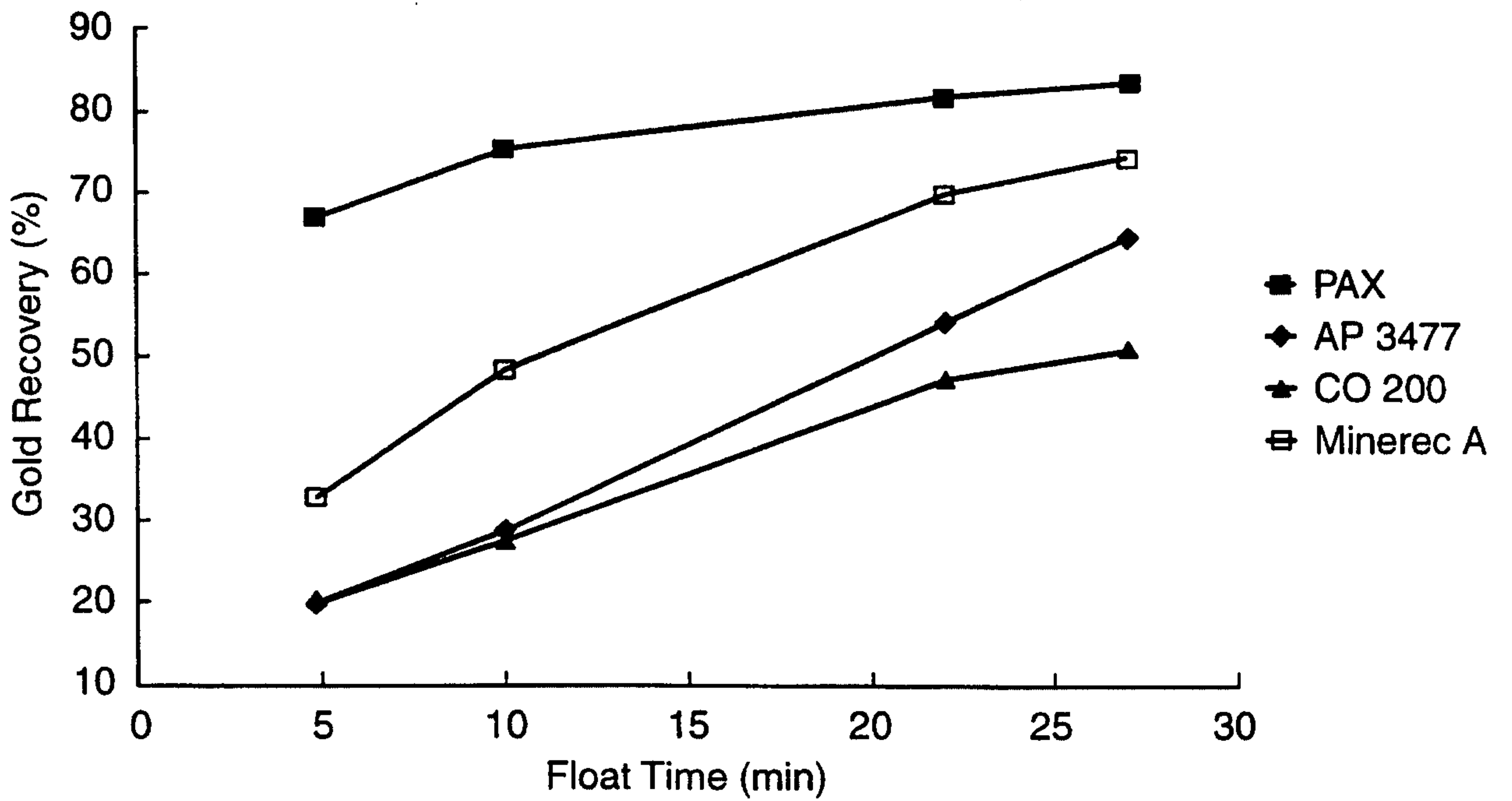

Fig. 22

21/24

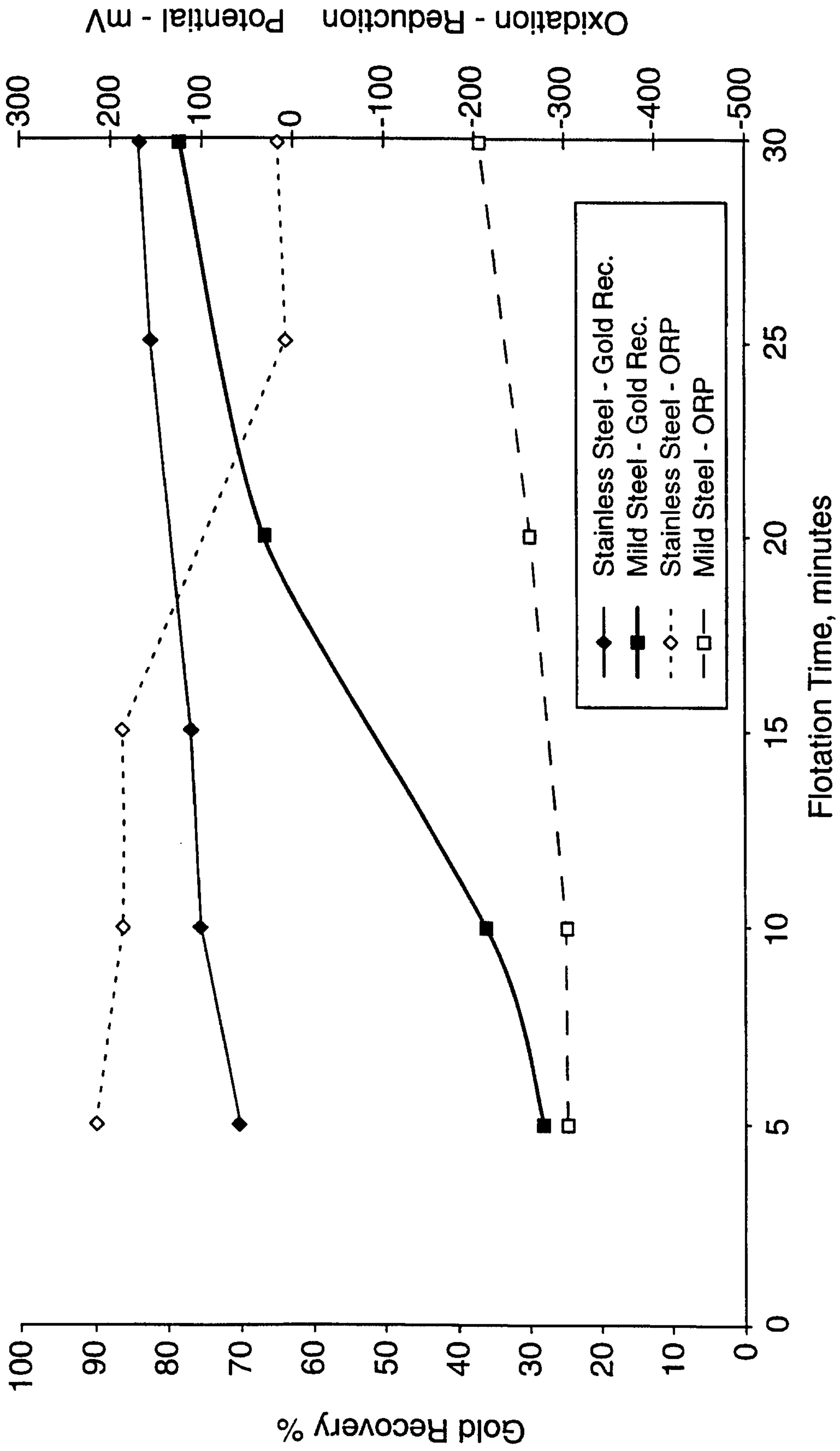

Fig. 23

22/24

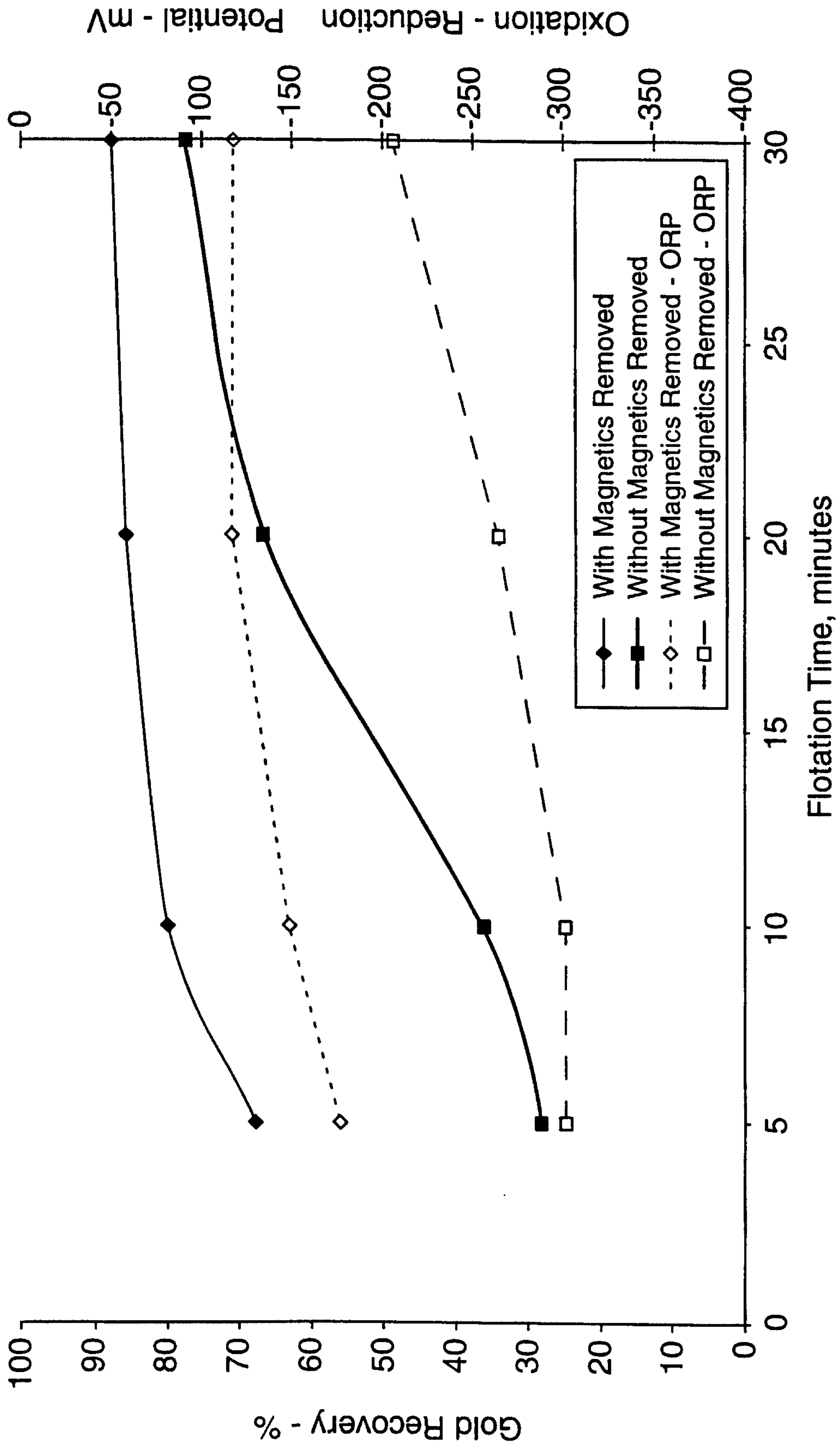

Fig. 24

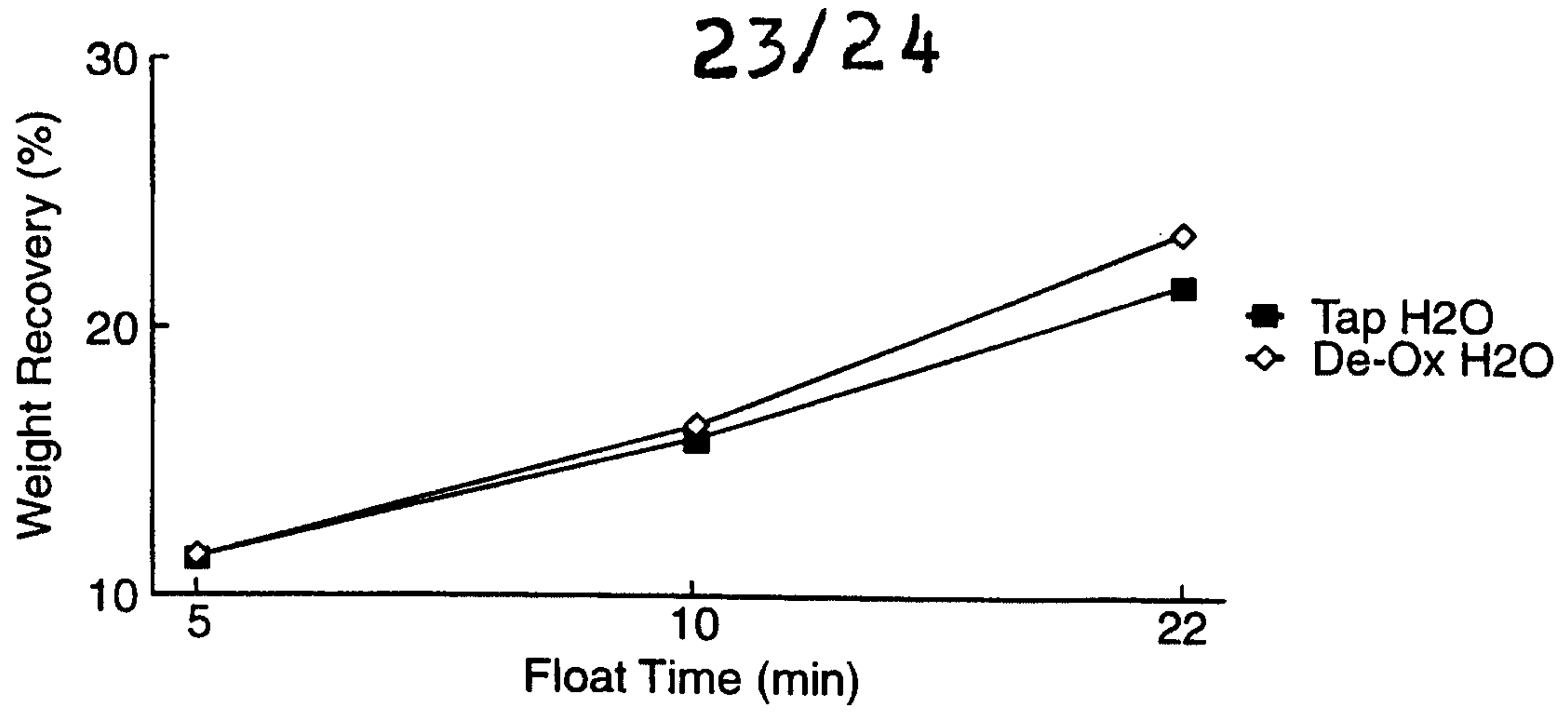

Fig. 25

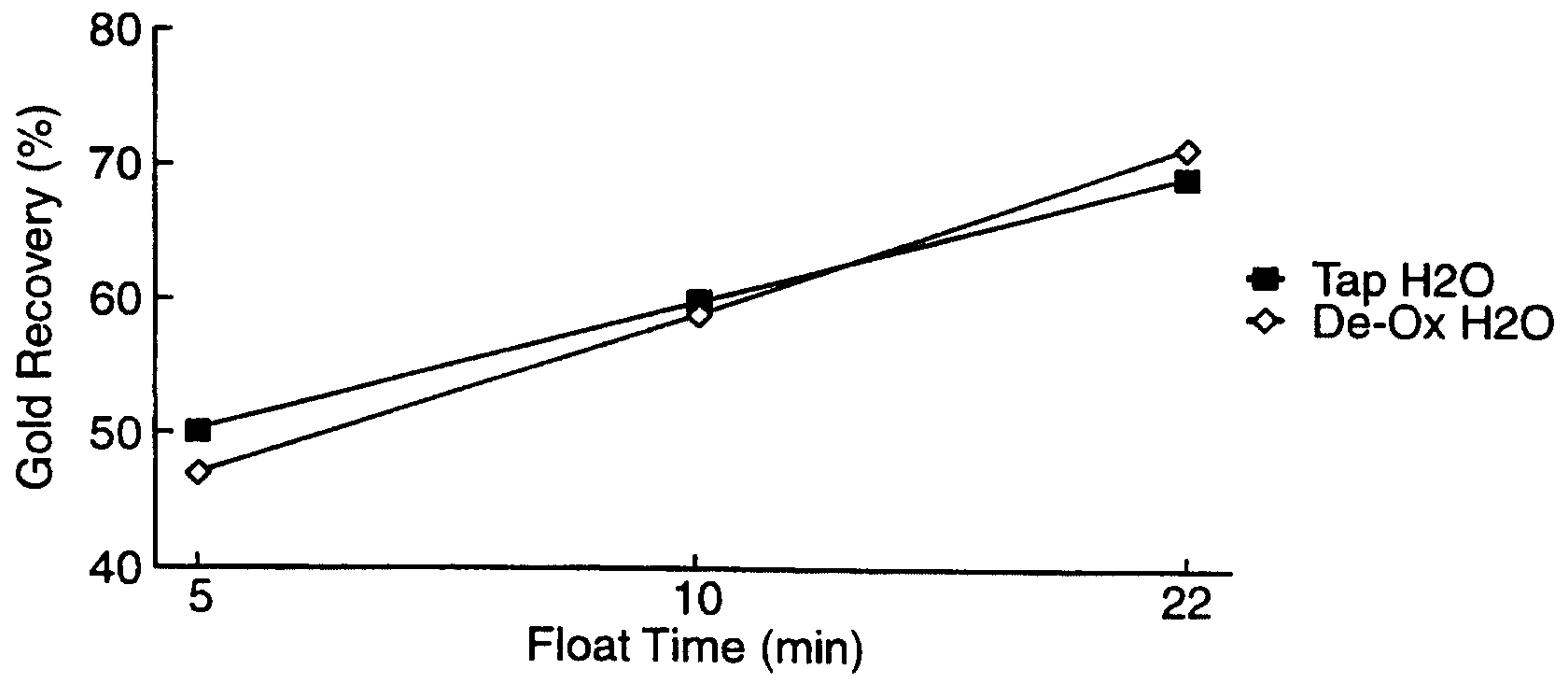

Fig. 26

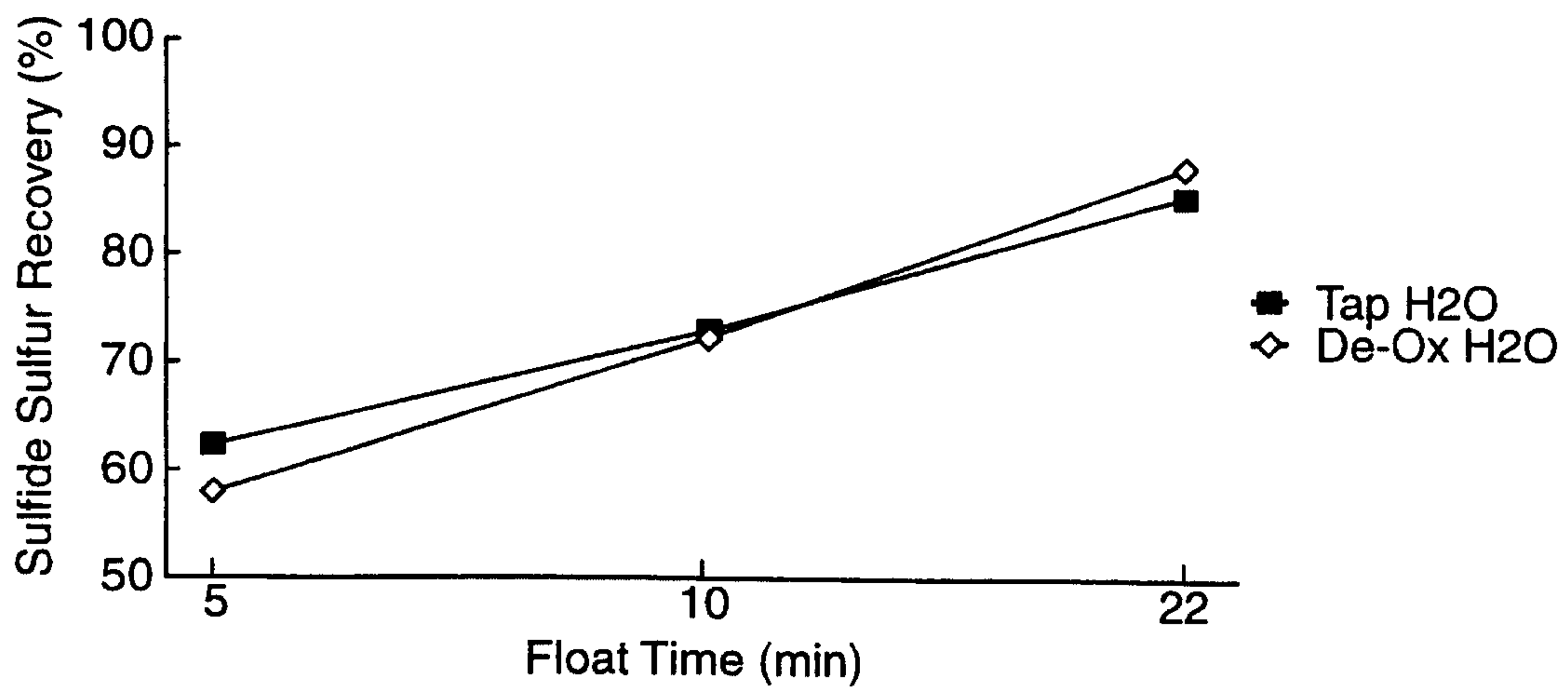

Fig. 27

24/24

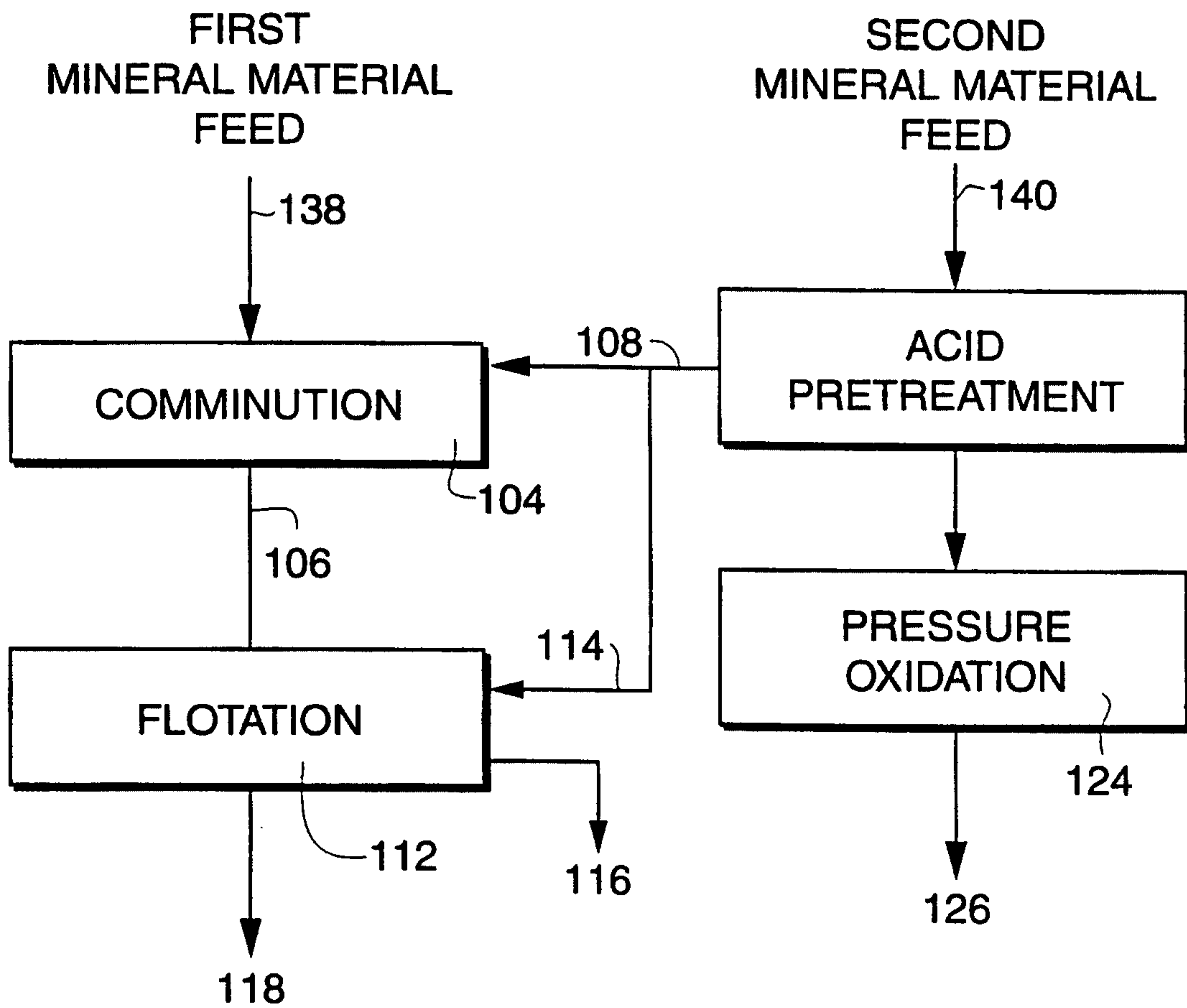

Fig. 28

