



(19) **United States**

(12) **Patent Application Publication**

**Yang et al.**

(10) **Pub. No.: US 2014/0333602 A1**

(43) **Pub. Date: Nov. 13, 2014**

(54) **SYSTEM AND METHOD FOR MANAGING DISPLAY POWER CONSUMPTION**

**Publication Classification**

(71) Applicants: **Jinrong Yang**, Shanghai (CN); **Ramzi Khalil Maalouf**, Chevy Chase, MD (US)

(51) **Int. Cl.**  
**G06F 1/32** (2006.01)

(72) Inventors: **Jinrong Yang**, Shanghai (CN); **Ramzi Khalil Maalouf**, Chevy Chase, MD (US)

(52) **U.S. Cl.**  
CPC ..... **G06F 1/3265** (2013.01)  
USPC ..... **345/212**

(21) Appl. No.: **14/257,888**

(57) **ABSTRACT**

(22) Filed: **Apr. 21, 2014**

A device includes a display screen that may be directed to function in one of multiple modes. The device may be configured to direct the display to shift between modes. In one mode, first information is displayed in an available display area including a first portion of a display screen in a display screen mode having a set of portions of the display screen. The set of portions may include the first portion of the display screen, which is configured in a powered-on state to perform display functions and receive user input, and a second portion of the display screen, which is configured in a powered-off state. In another mode, the entire screen may function in a powered-on state. One of the particular modes may be selected by swiping on object displayed by the screen to select a particular mode while the display is in a sleep mode.

**Related U.S. Application Data**

(63) Continuation-in-part of application No. 14/058,731, filed on Oct. 21, 2013, now Pat. No. 8,717,328, which is a continuation of application No. 13/905,064, filed on May 29, 2013, now Pat. No. 8,593,427.

(60) Provisional application No. 61/822,267, filed on May 10, 2013, provisional application No. 61/826,673, filed on May 23, 2013.

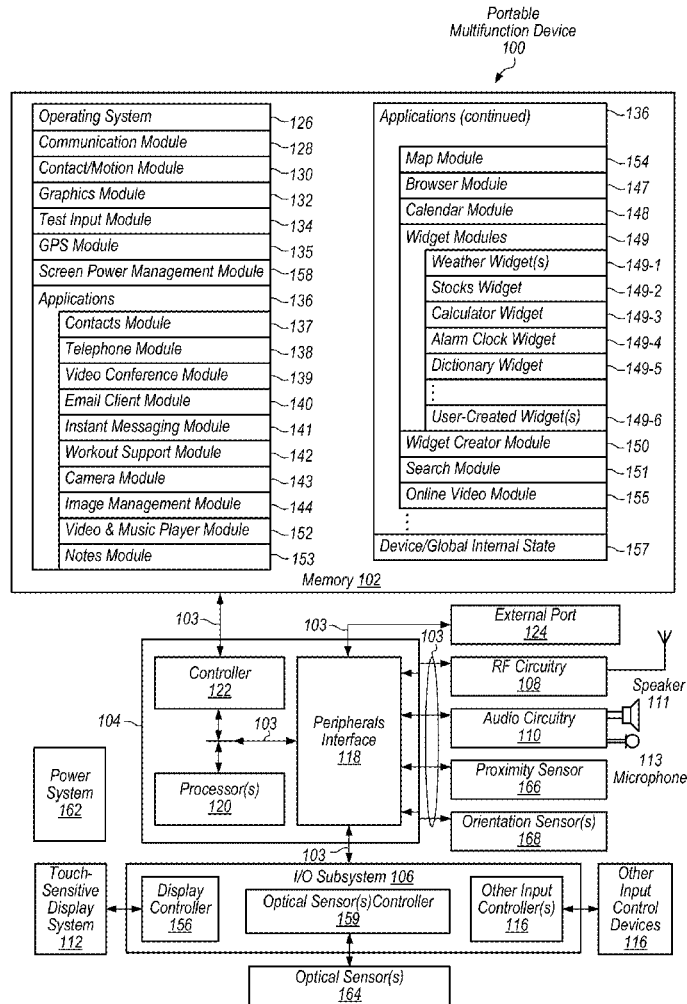

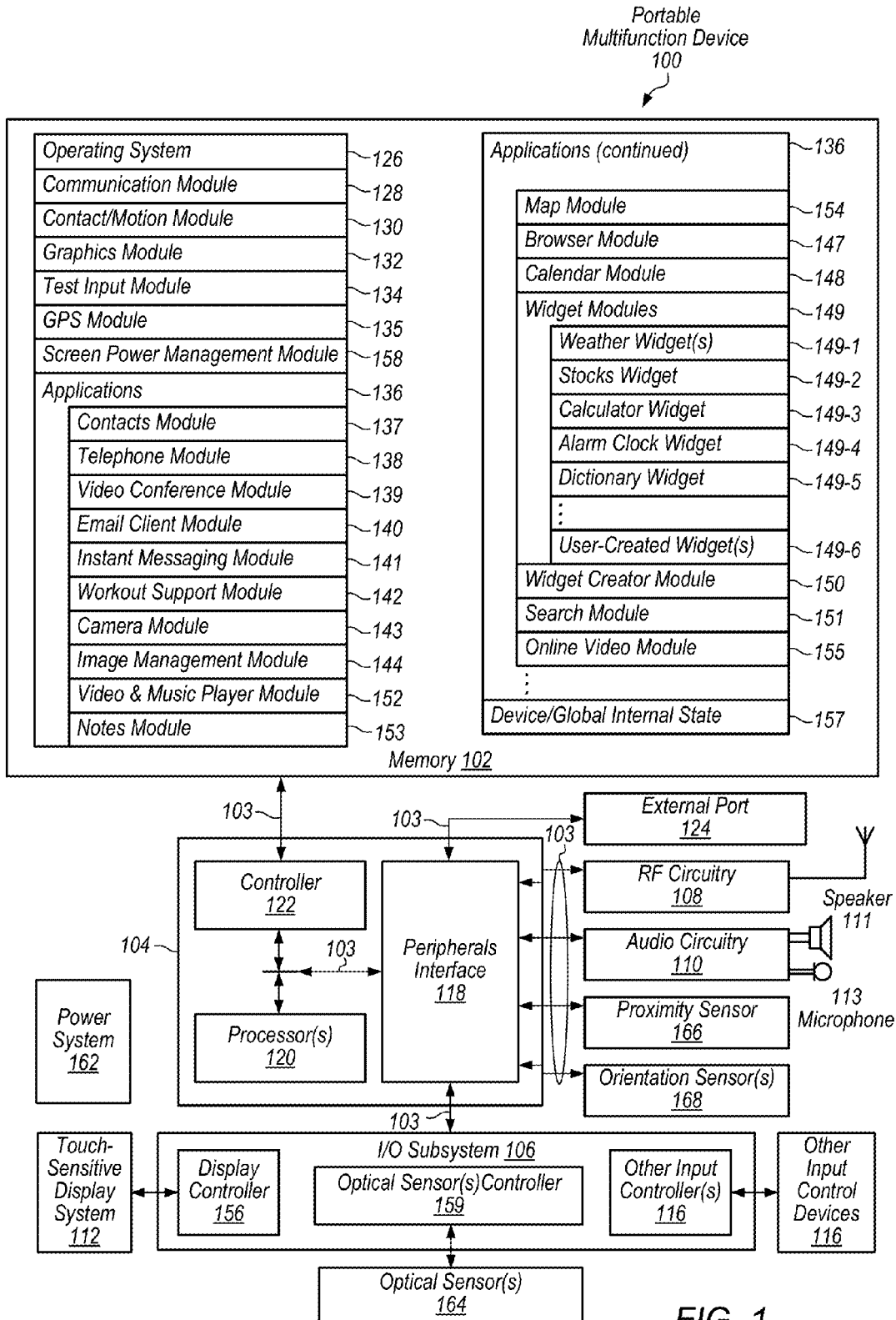

FIG. 1

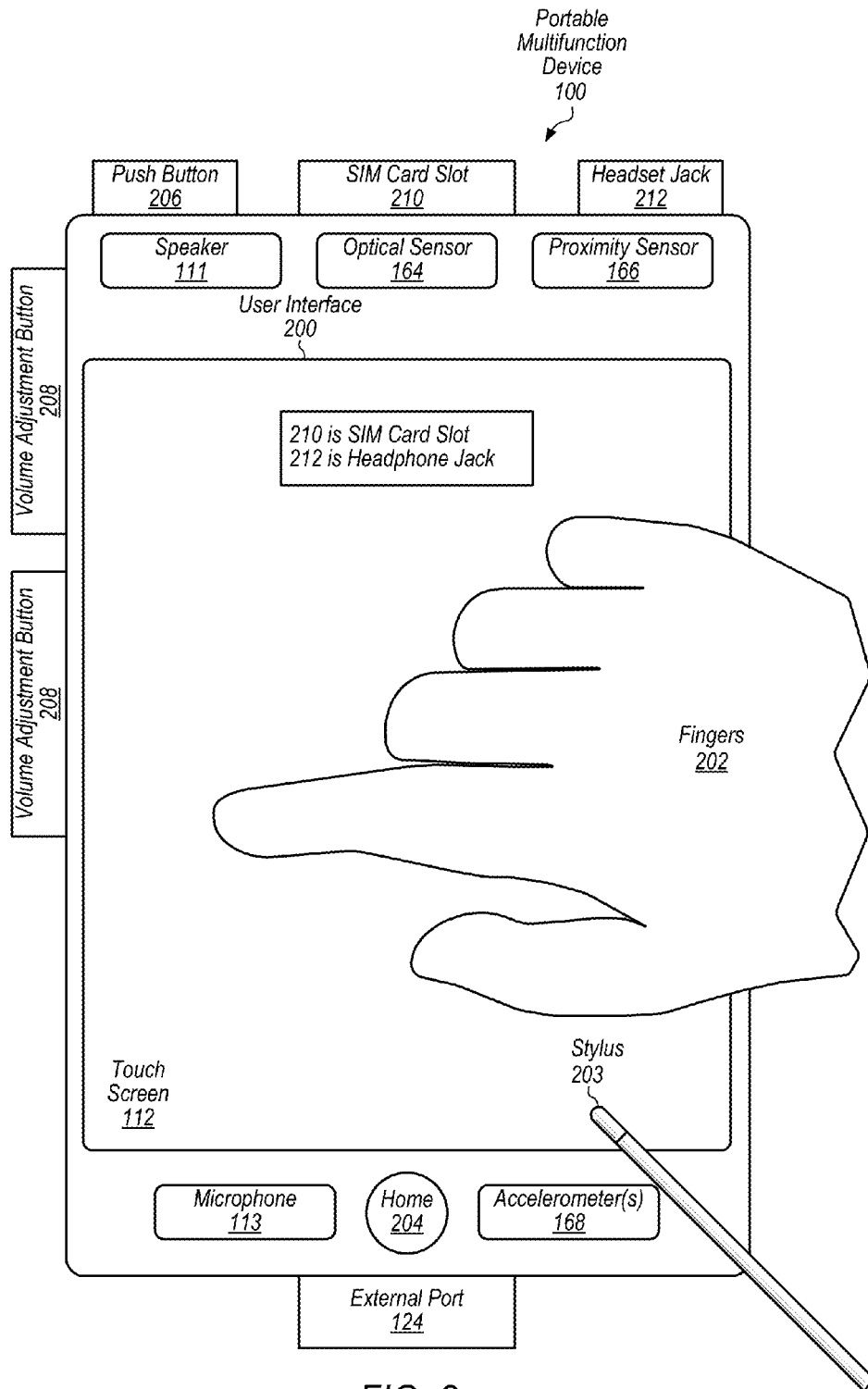

FIG. 2

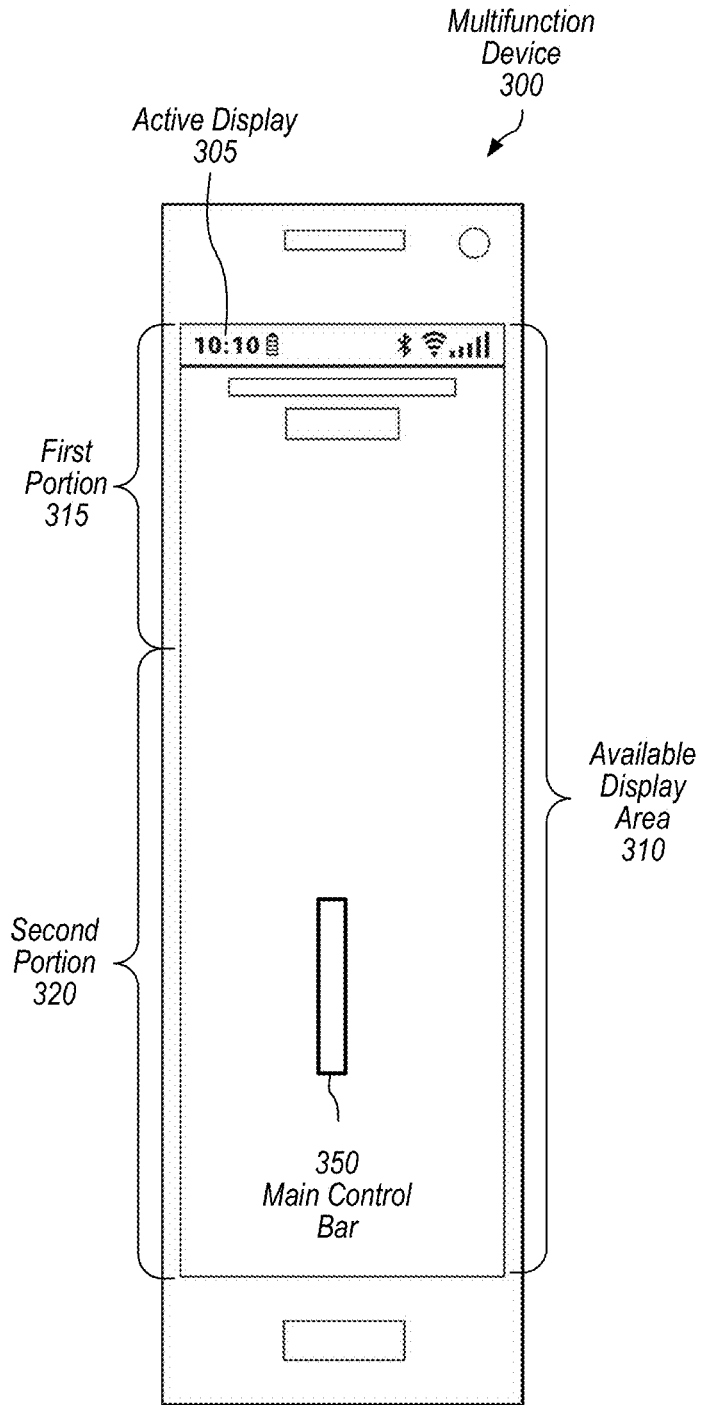

FIG. 3

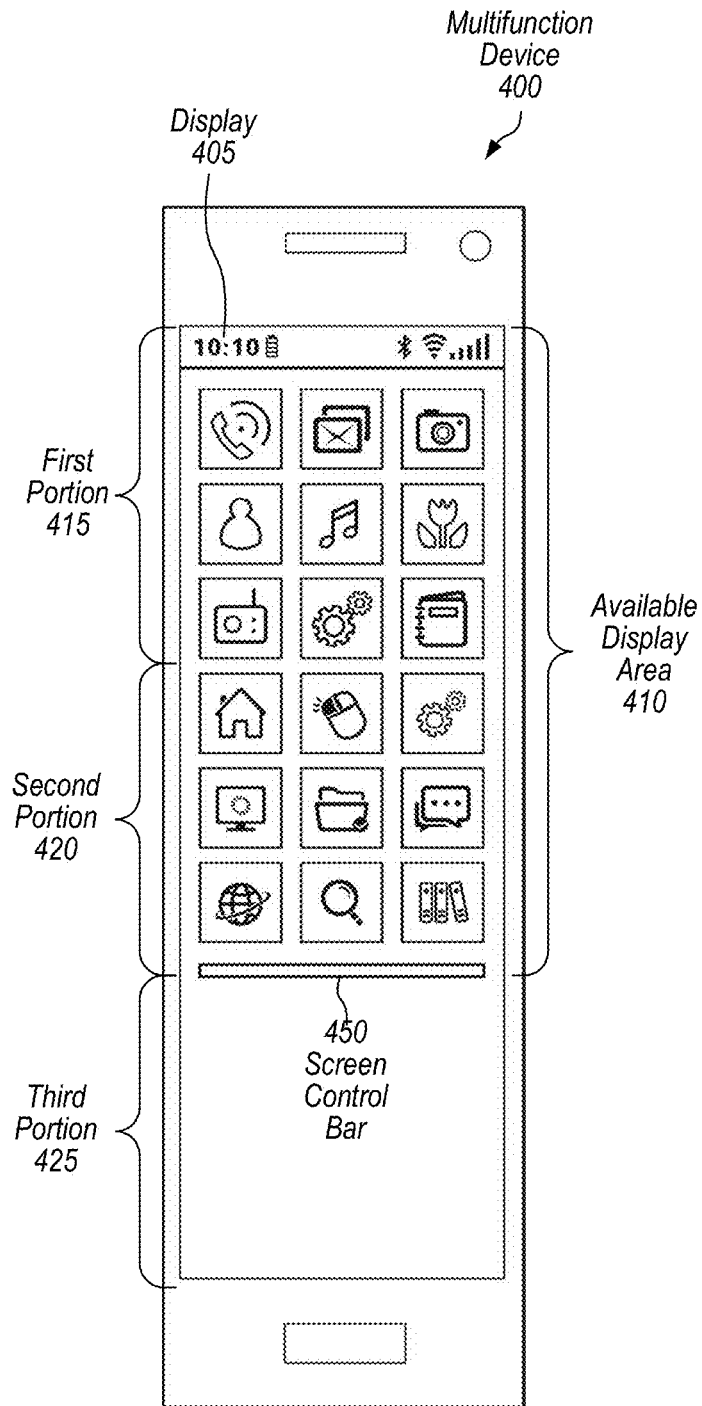

FIG. 4

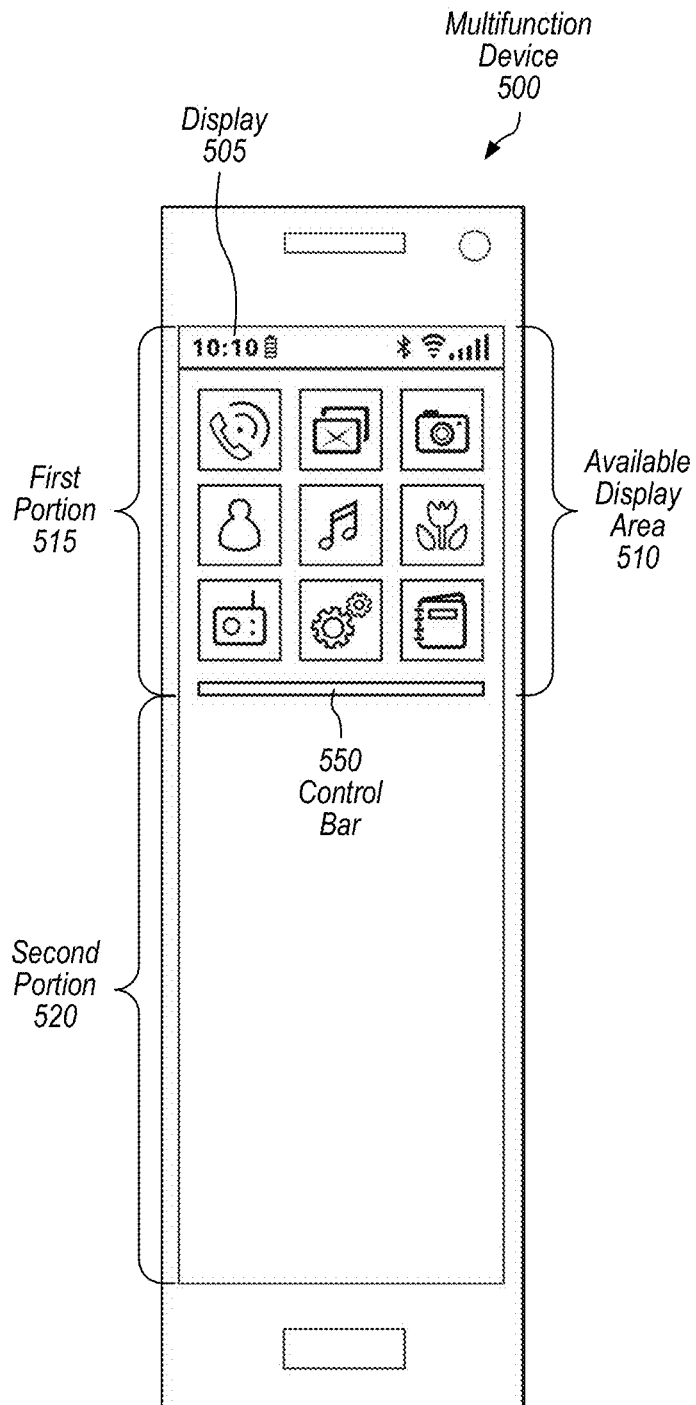

FIG. 5

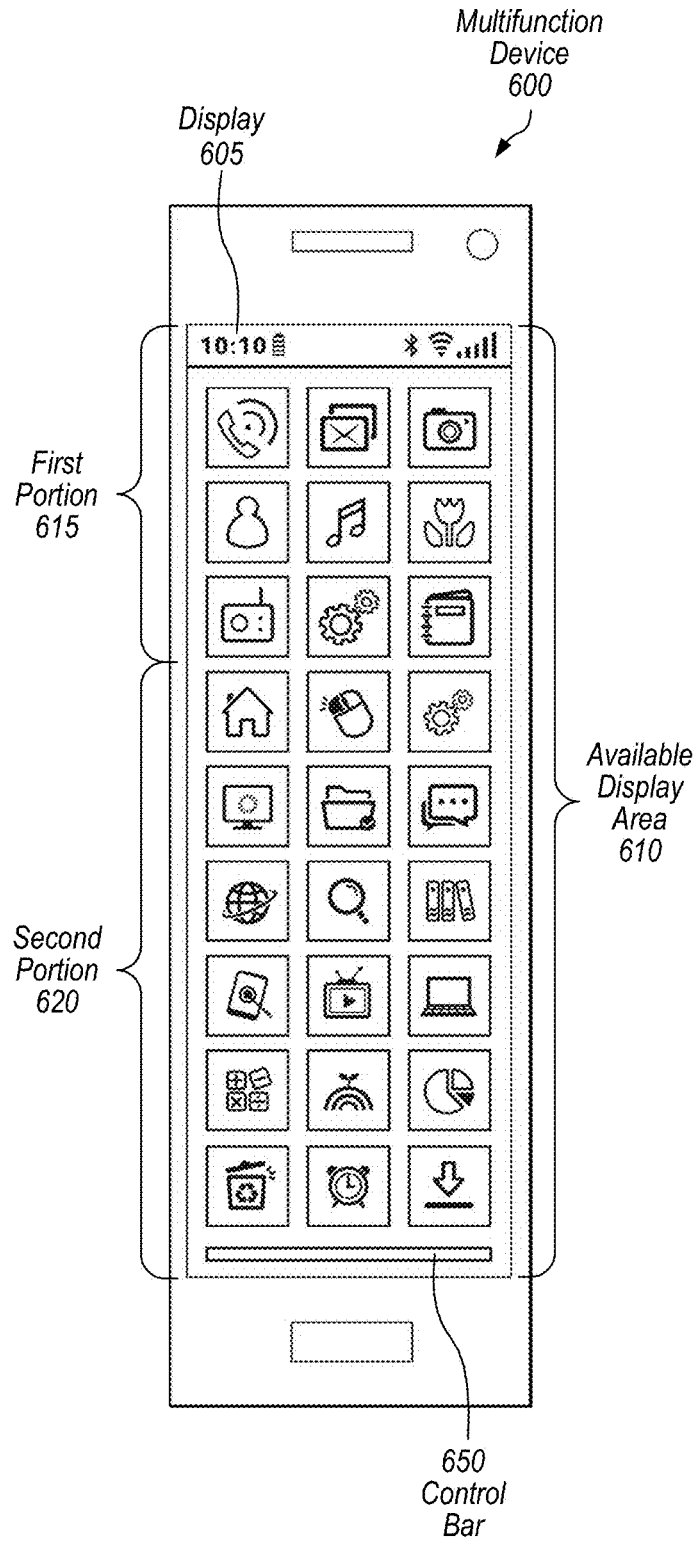

FIG. 6

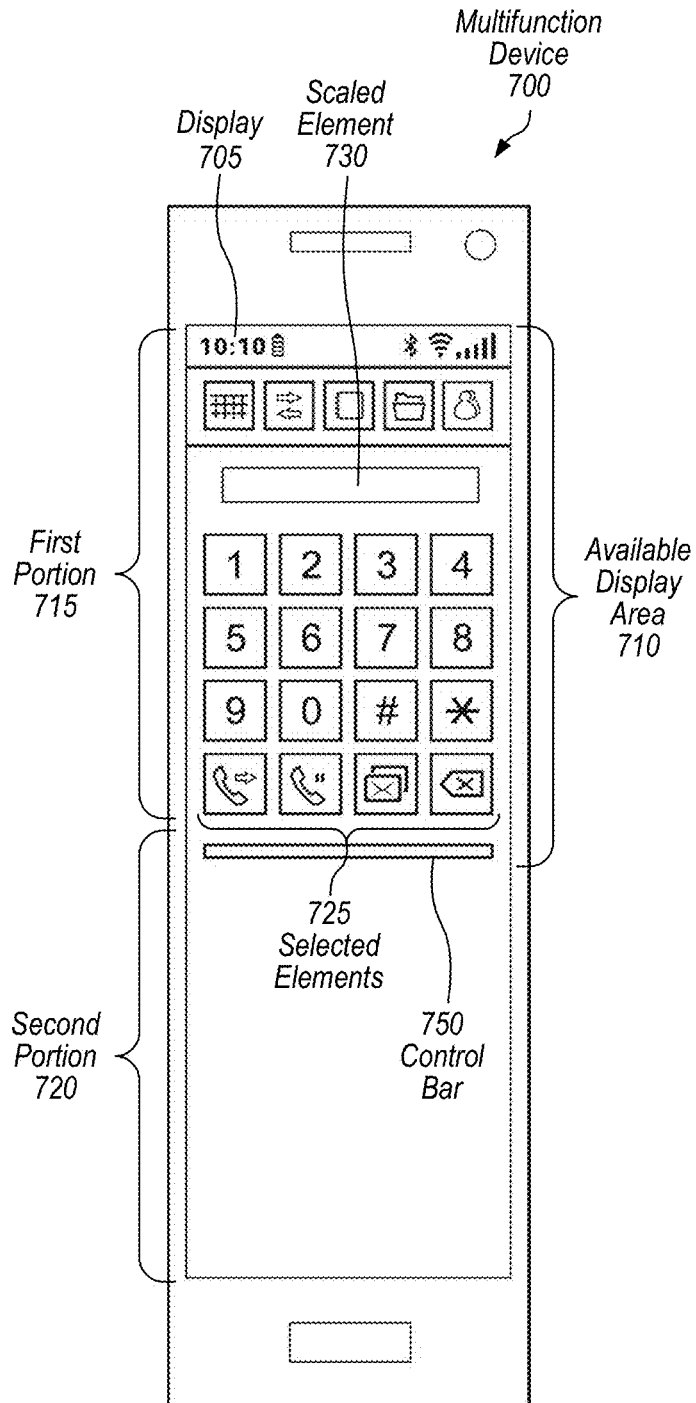

FIG. 7



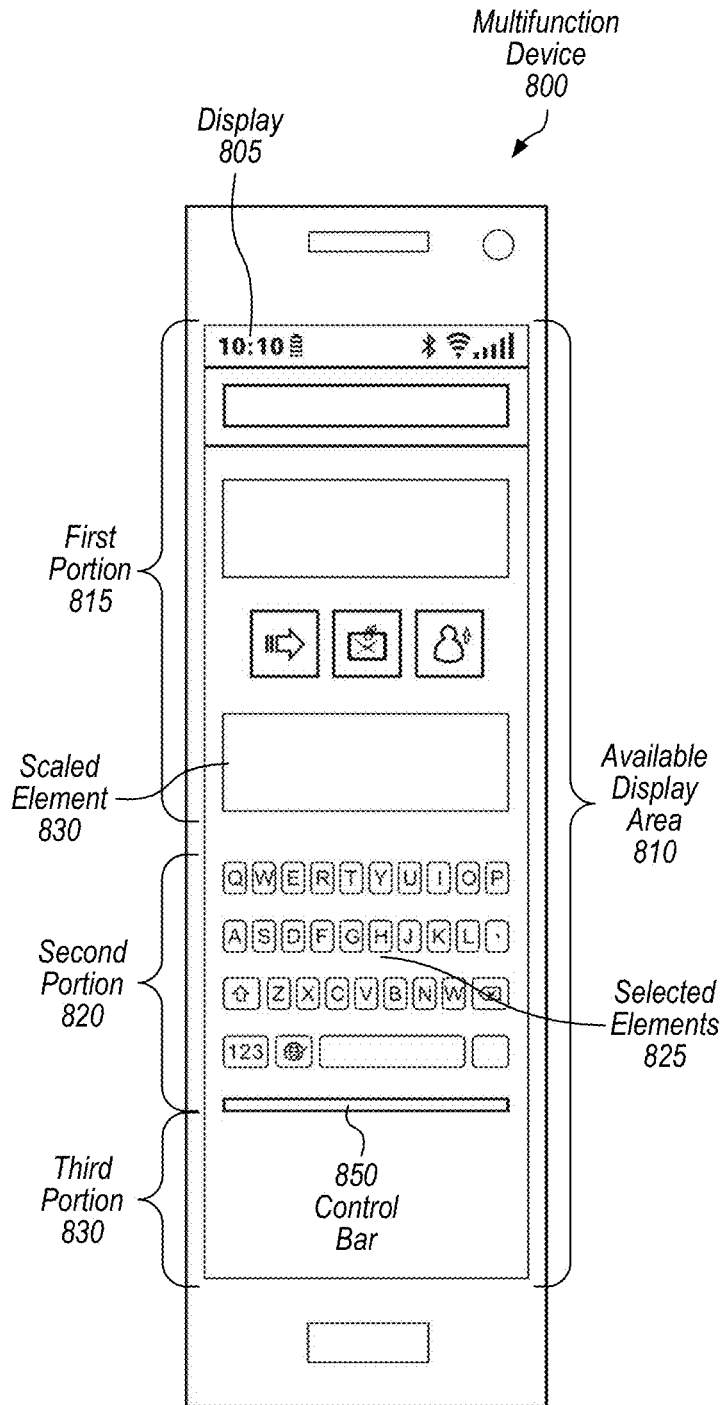

FIG. 8

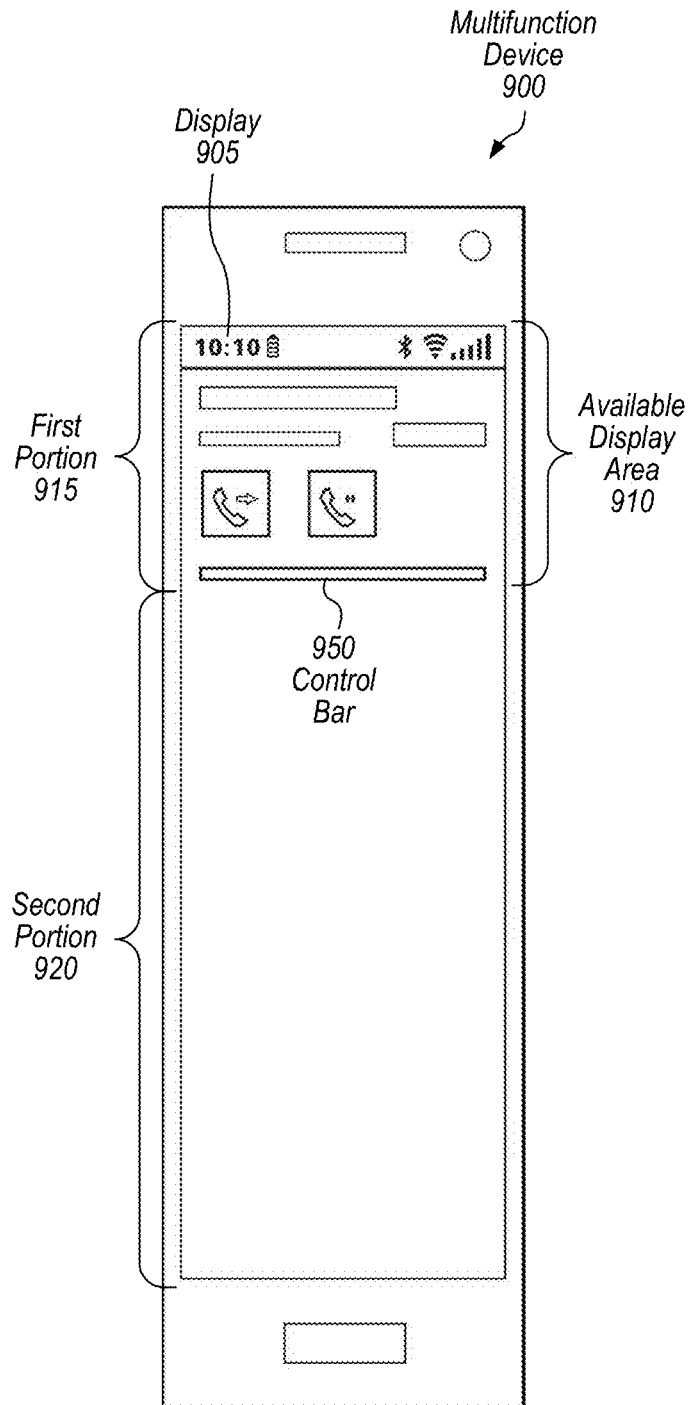

FIG. 9

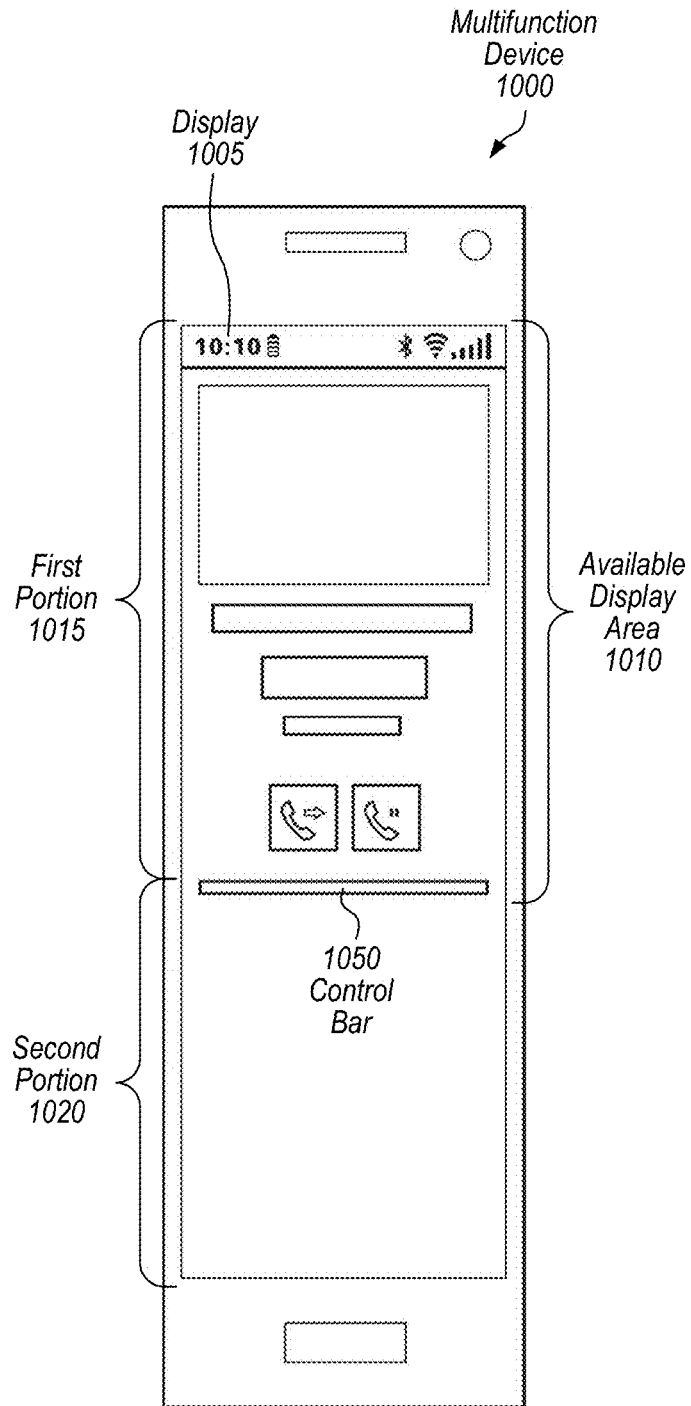

FIG. 10

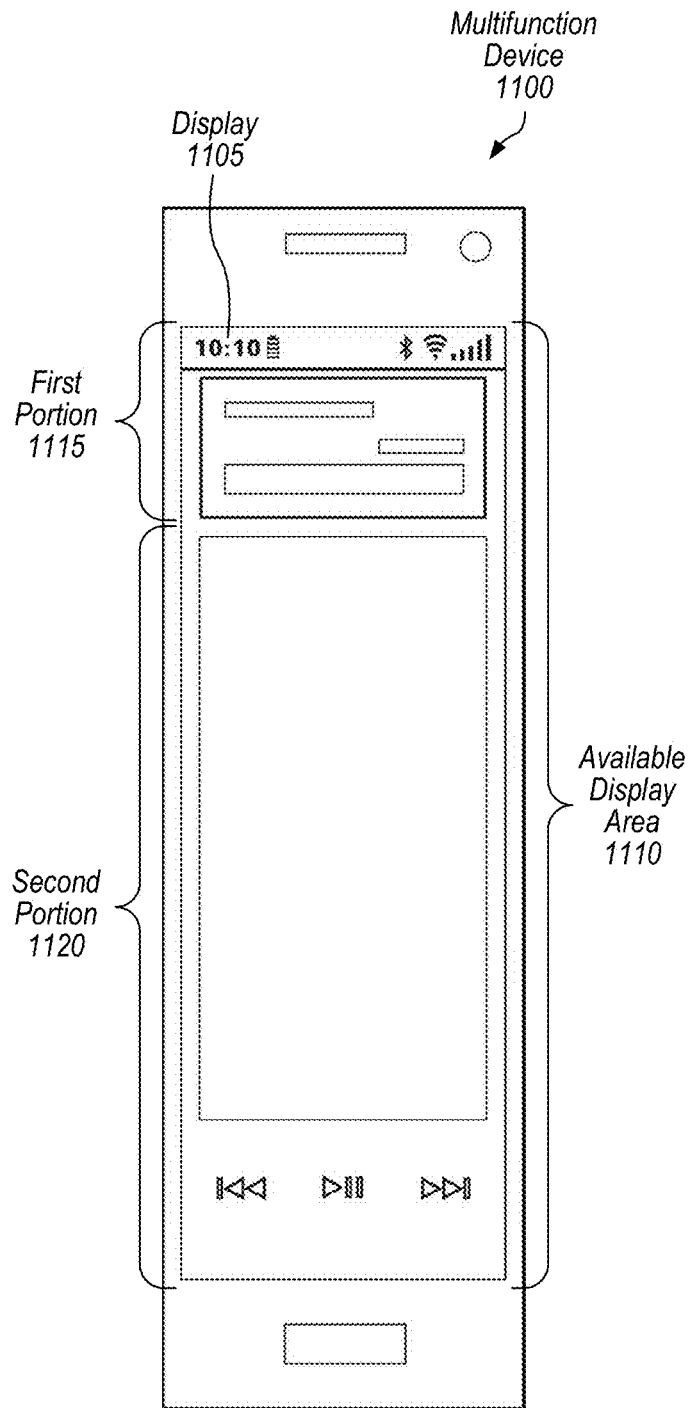

FIG. 11

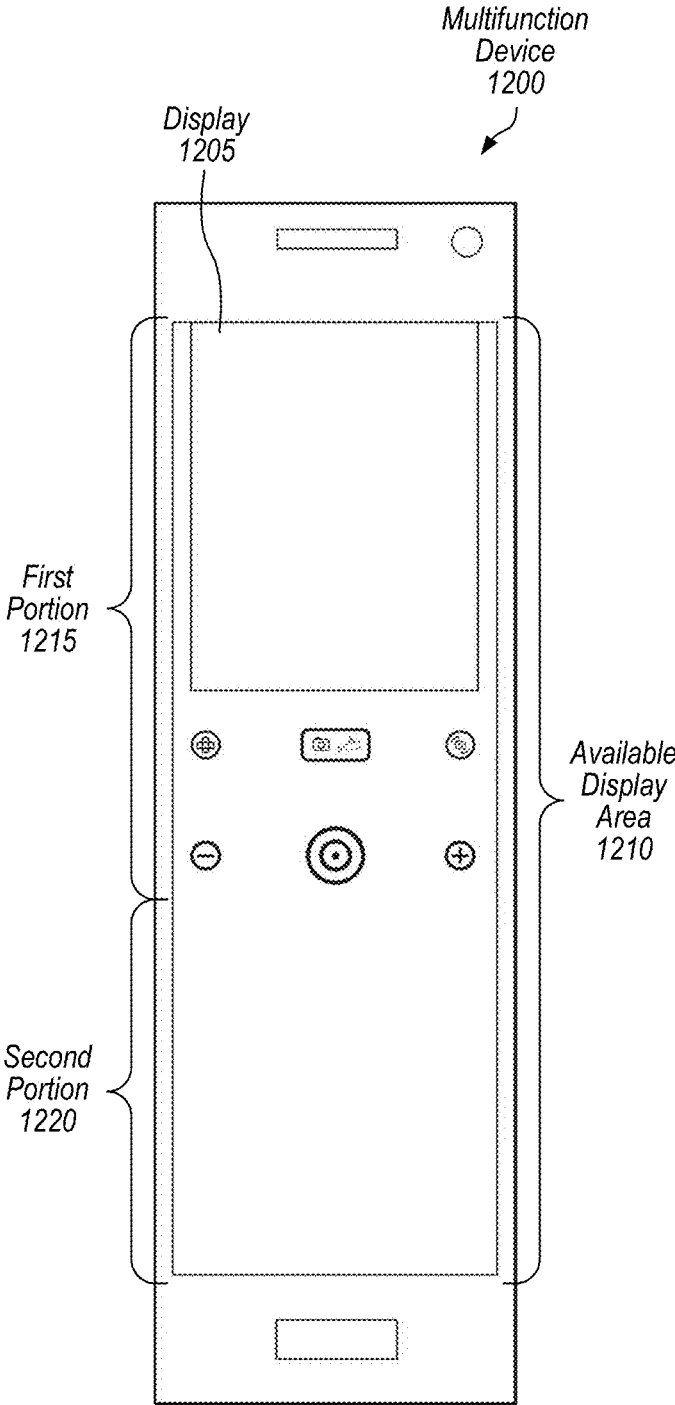

FIG. 12

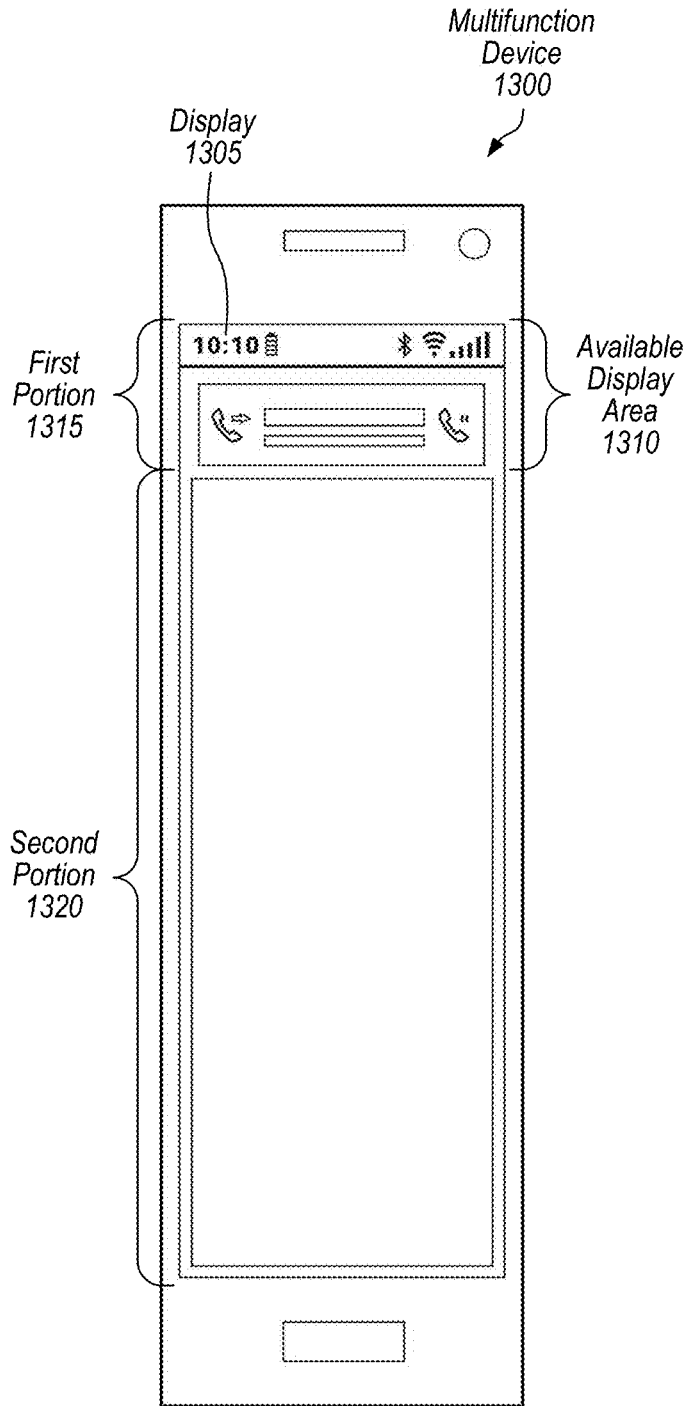

FIG. 13

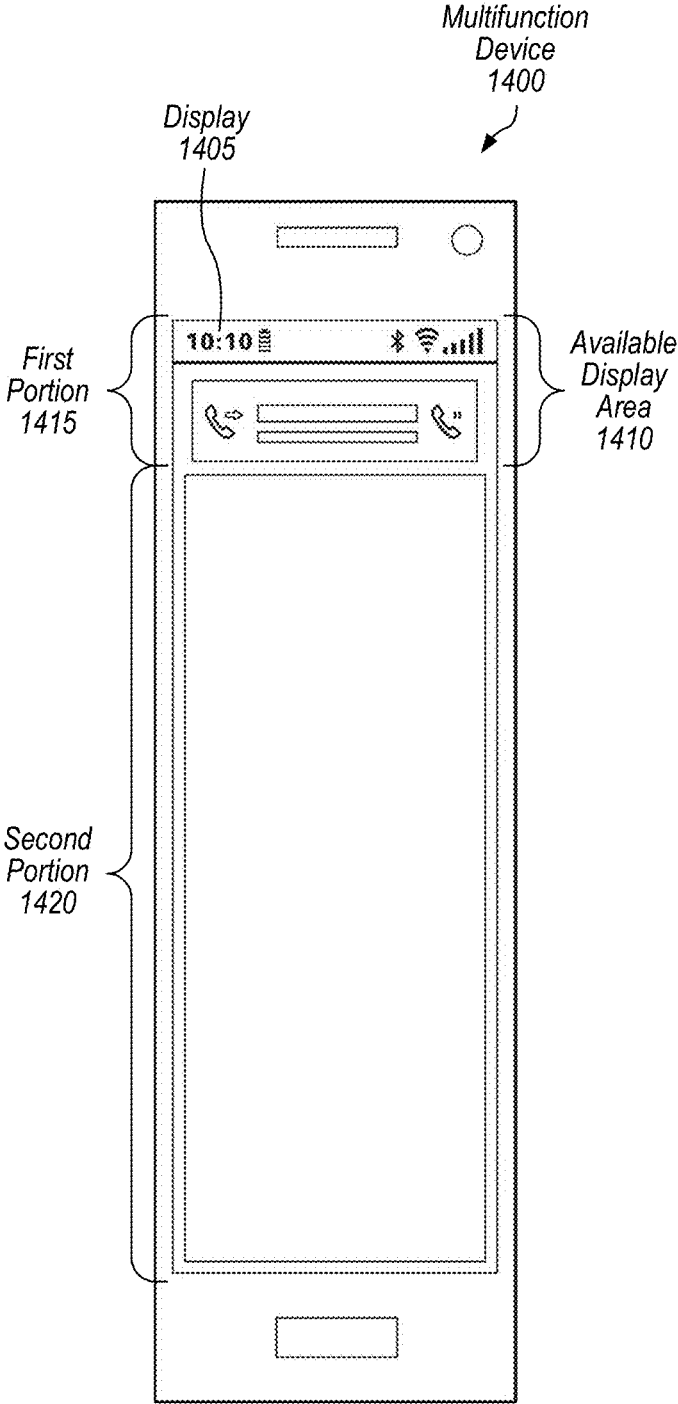

FIG. 14

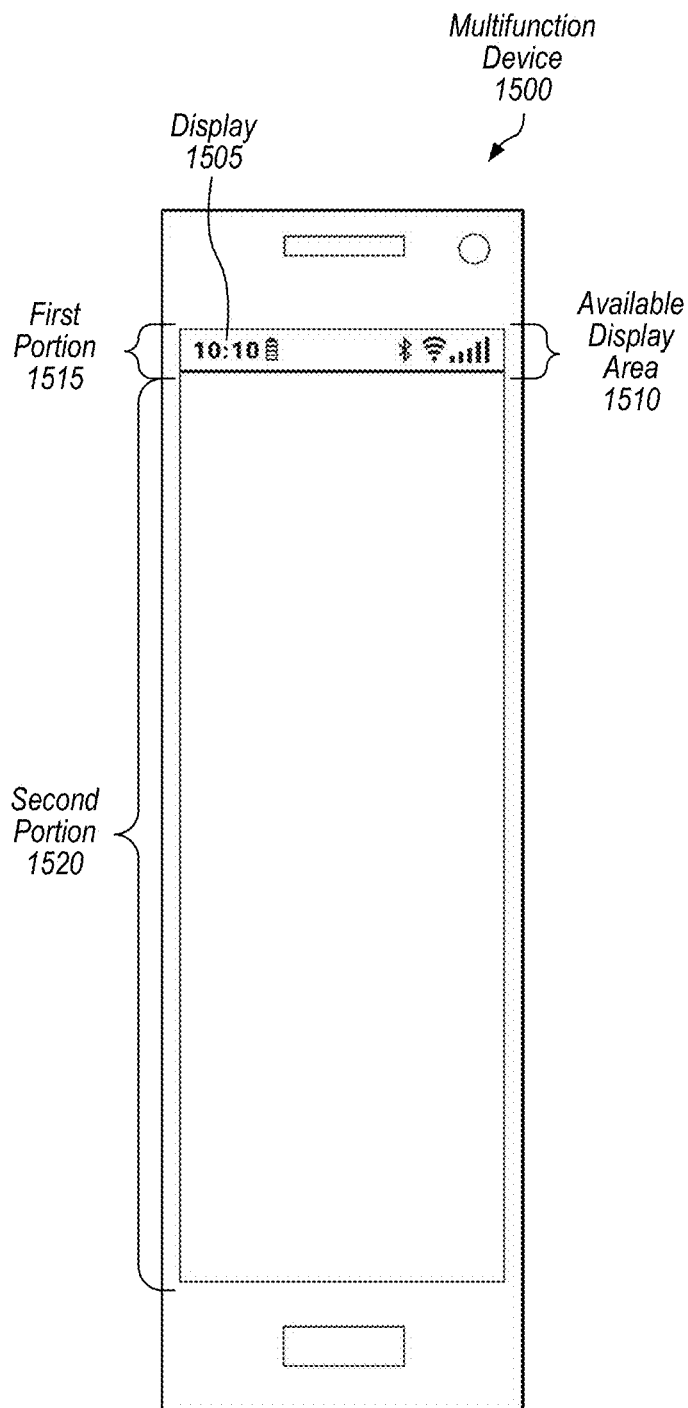

FIG. 15



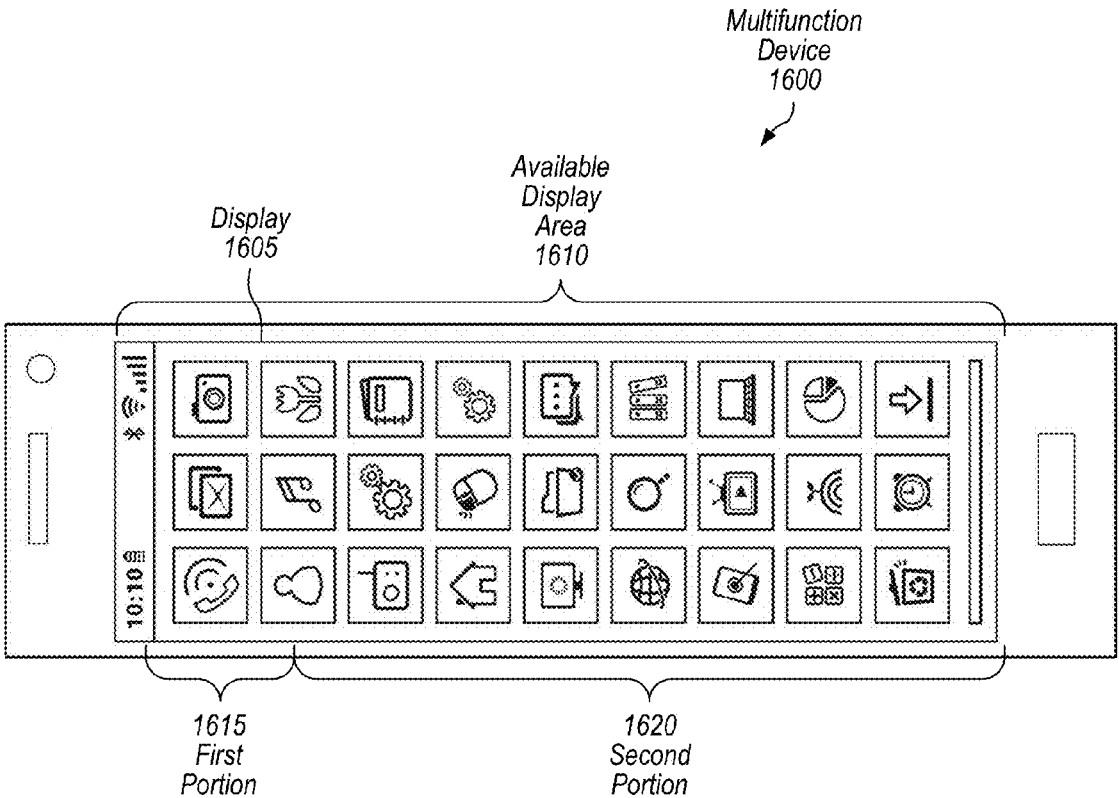

FIG. 16

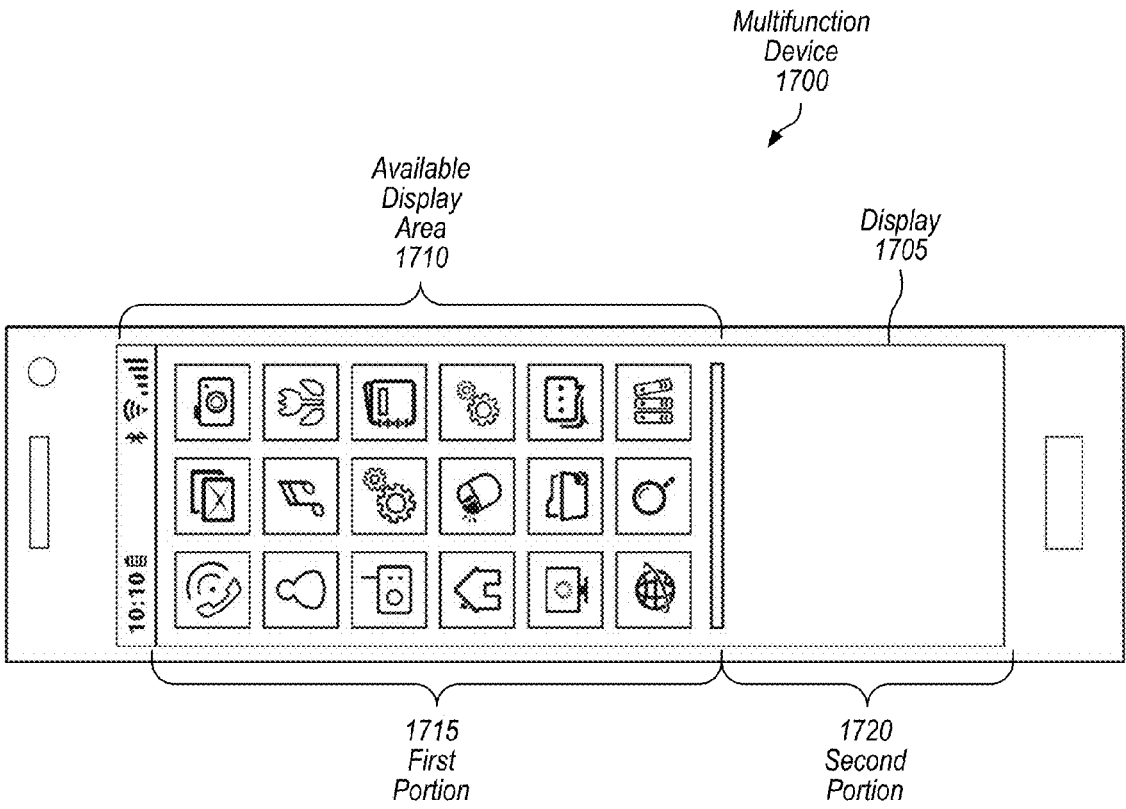

FIG. 17

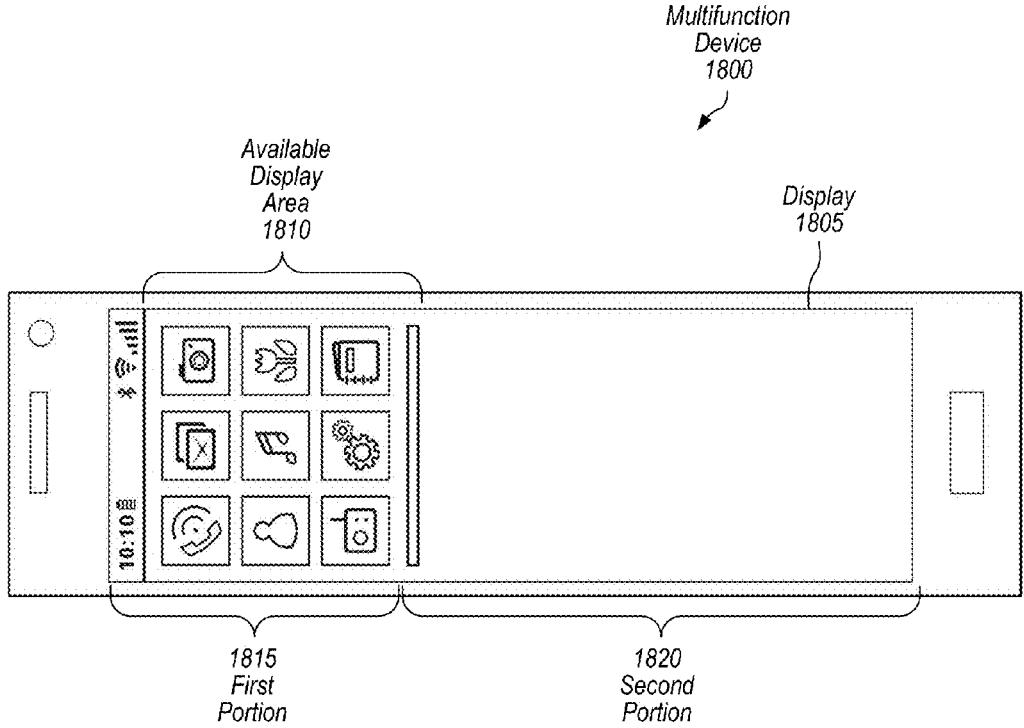

FIG. 18

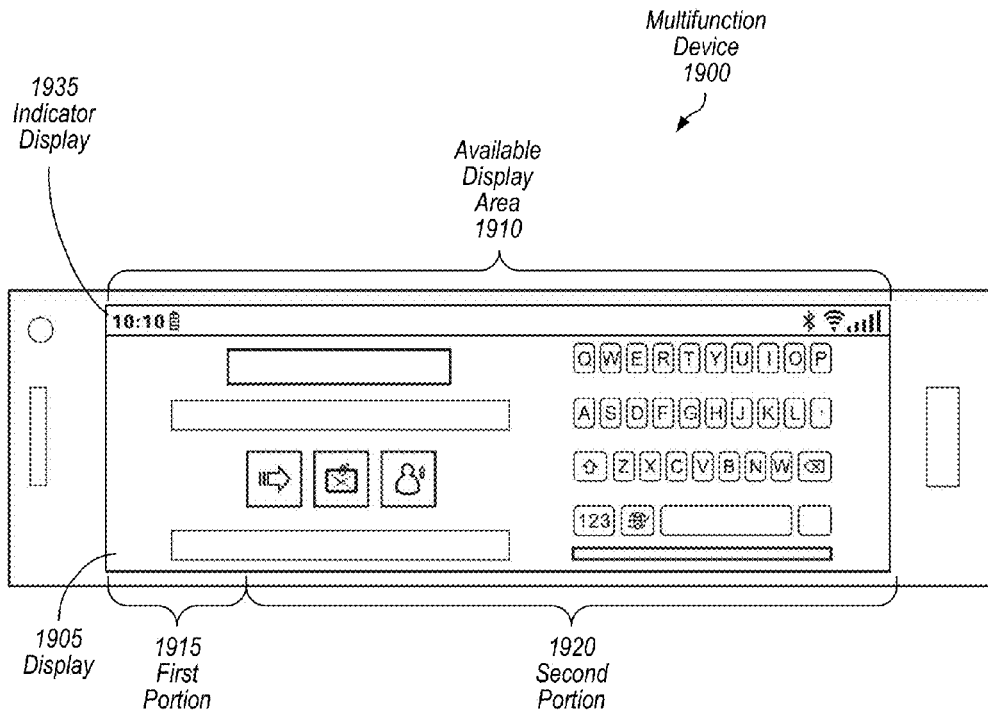

FIG. 19

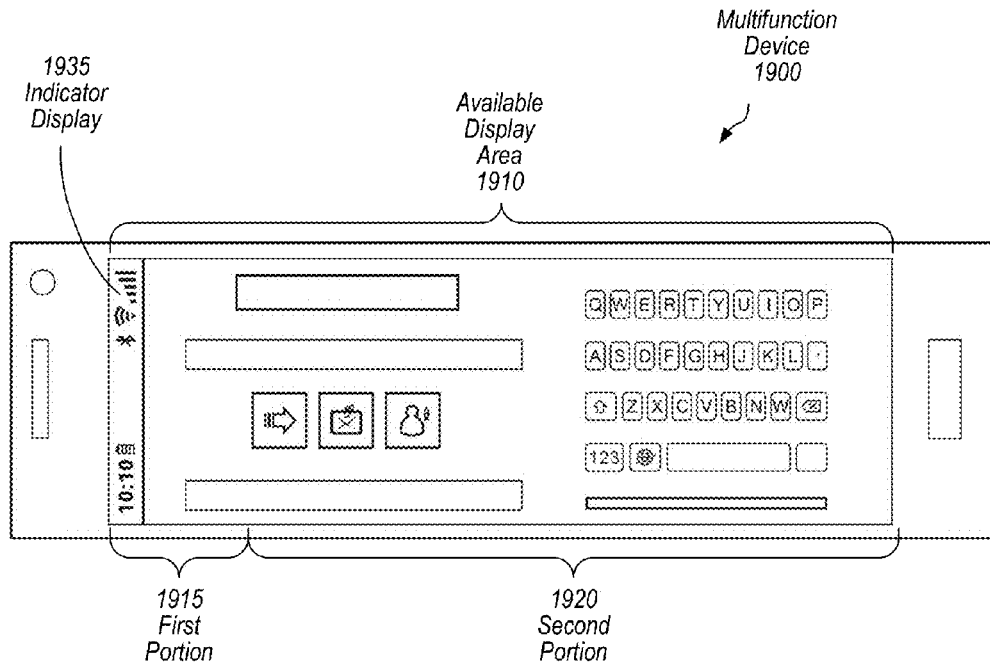

FIG. 19A

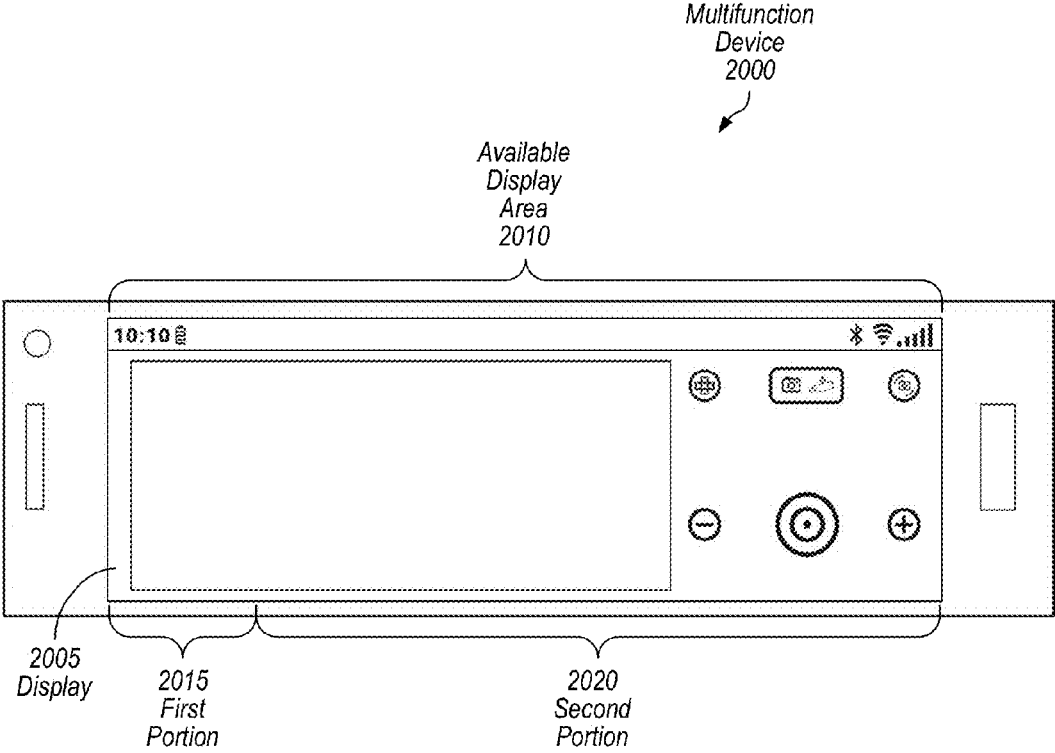

FIG. 20

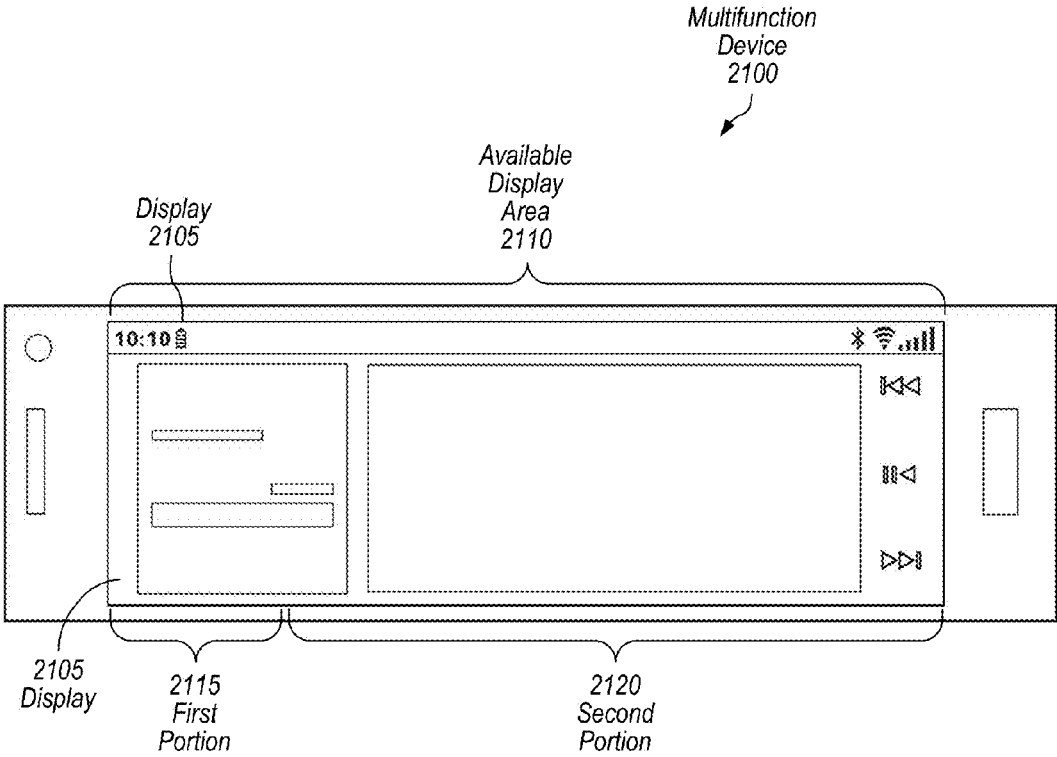

FIG. 21

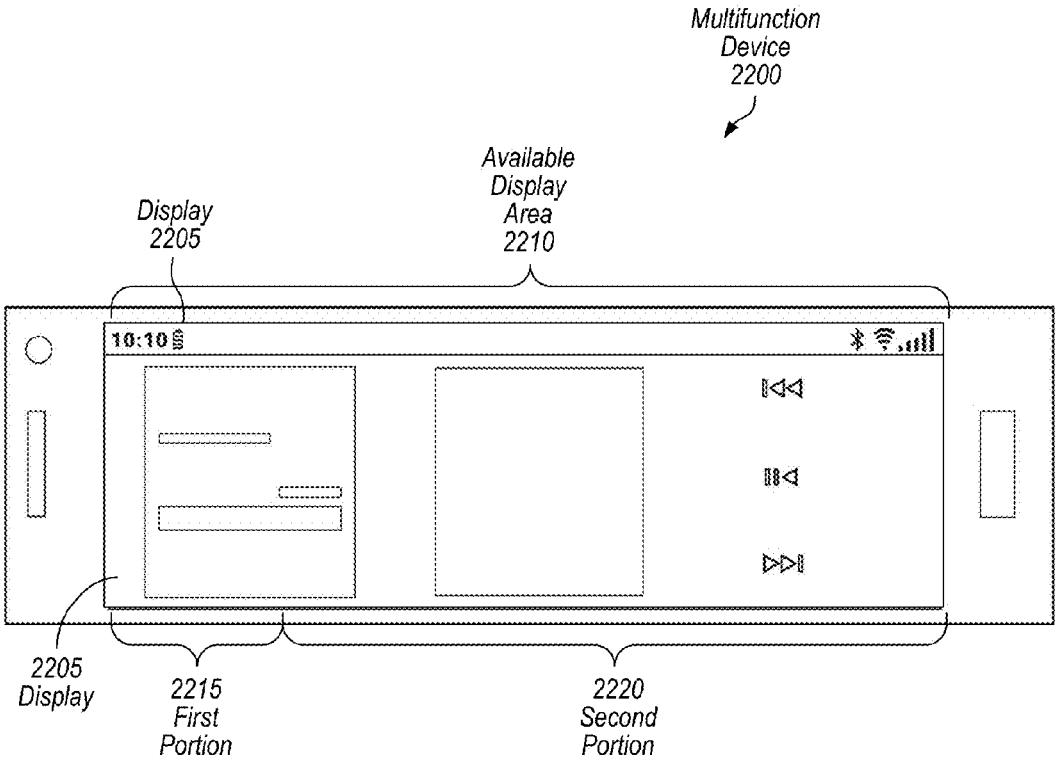

FIG. 22

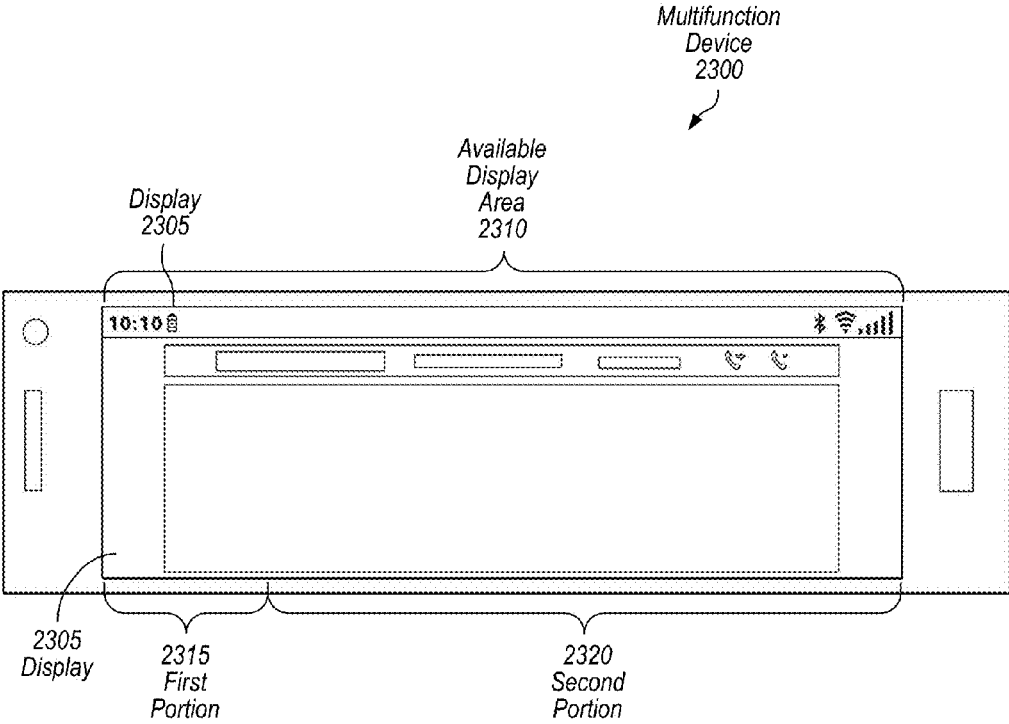

FIG. 23



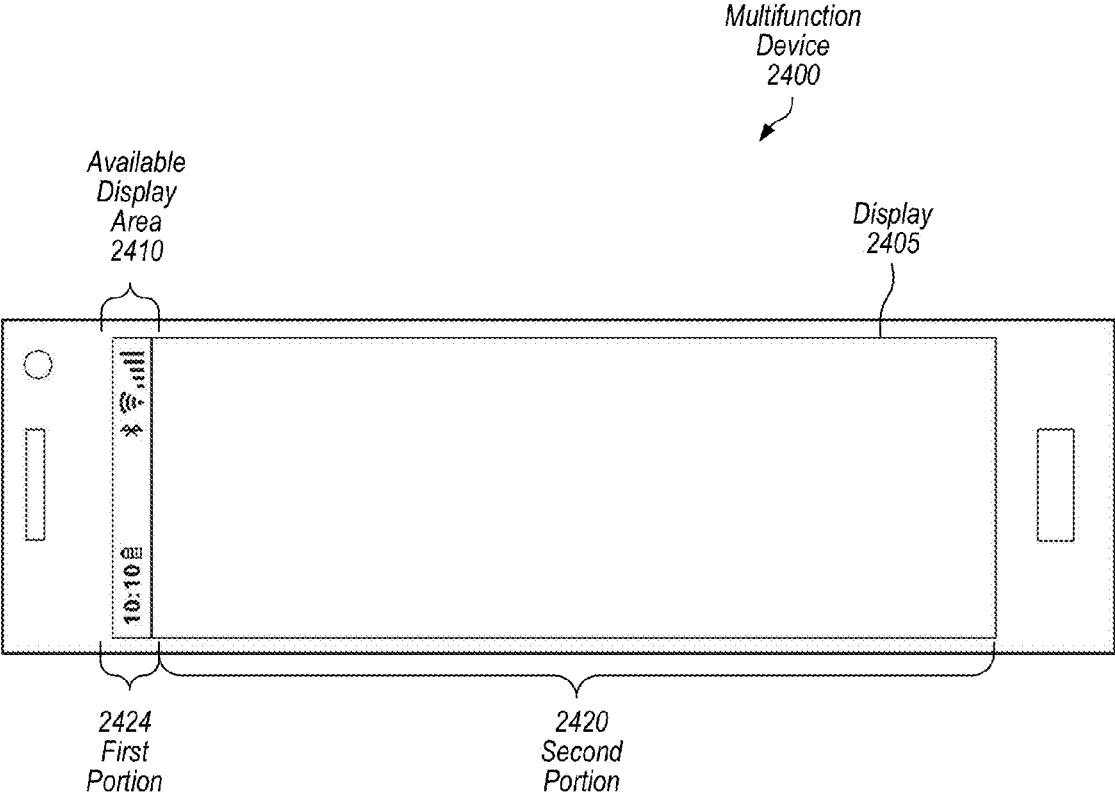

FIG. 24

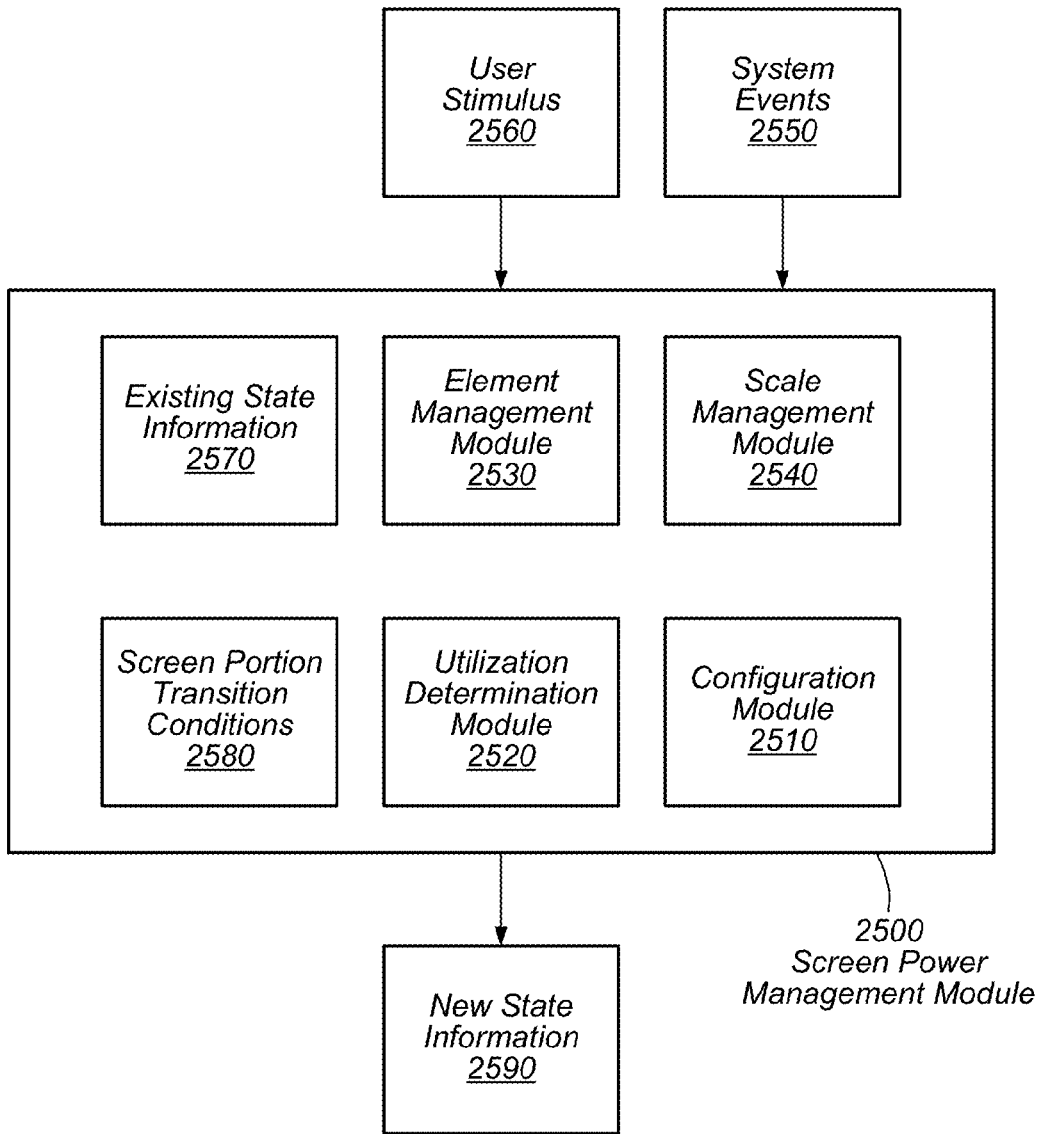

FIG. 25

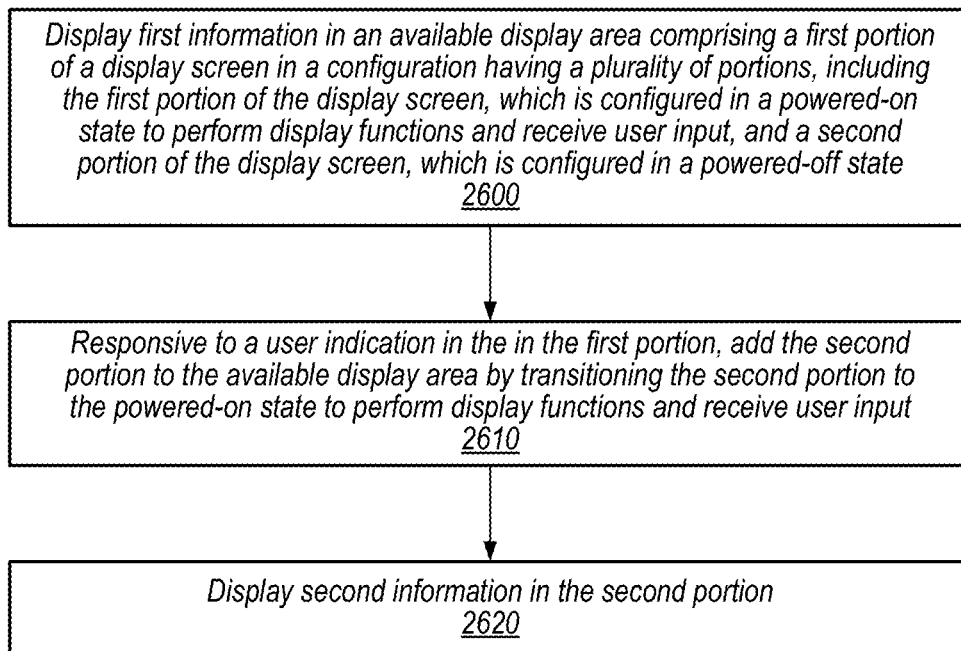

FIG. 26

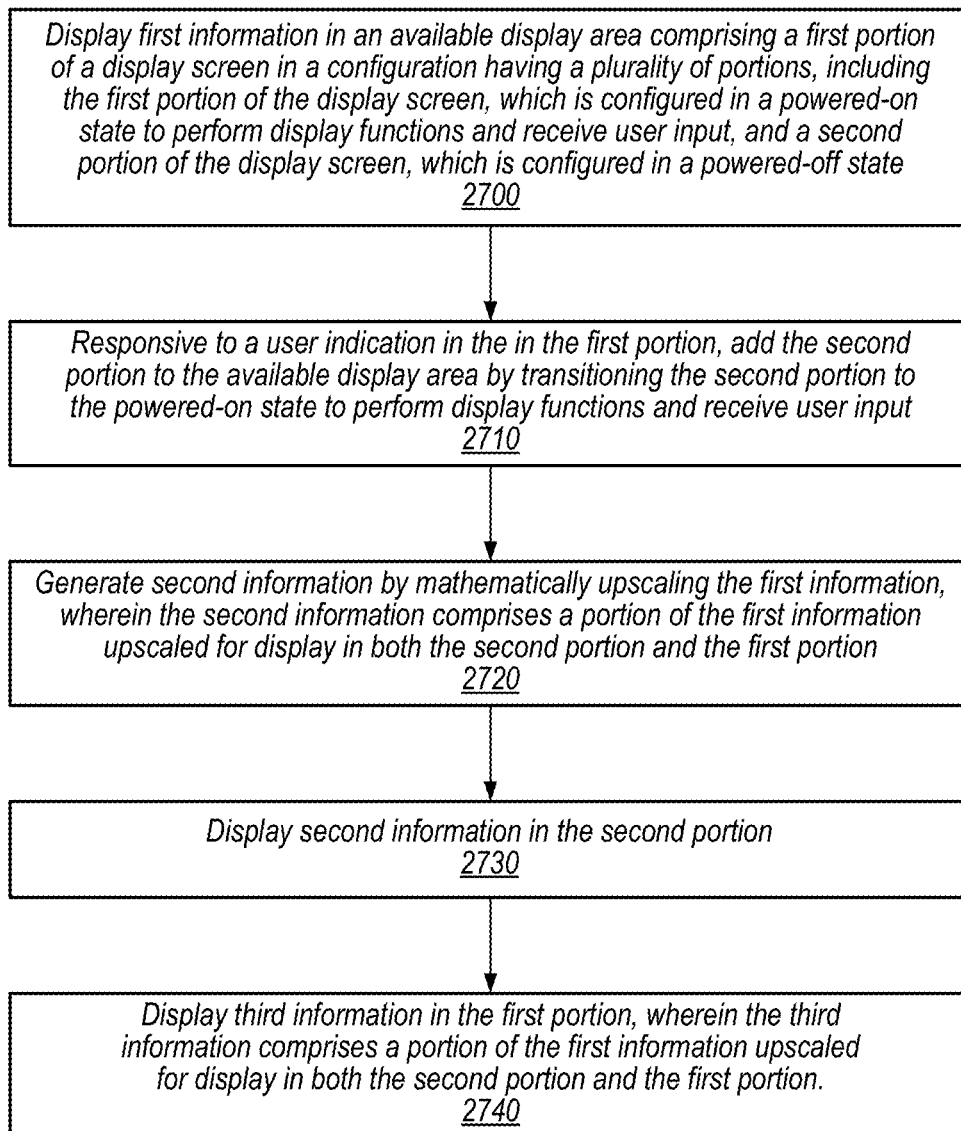

FIG. 27

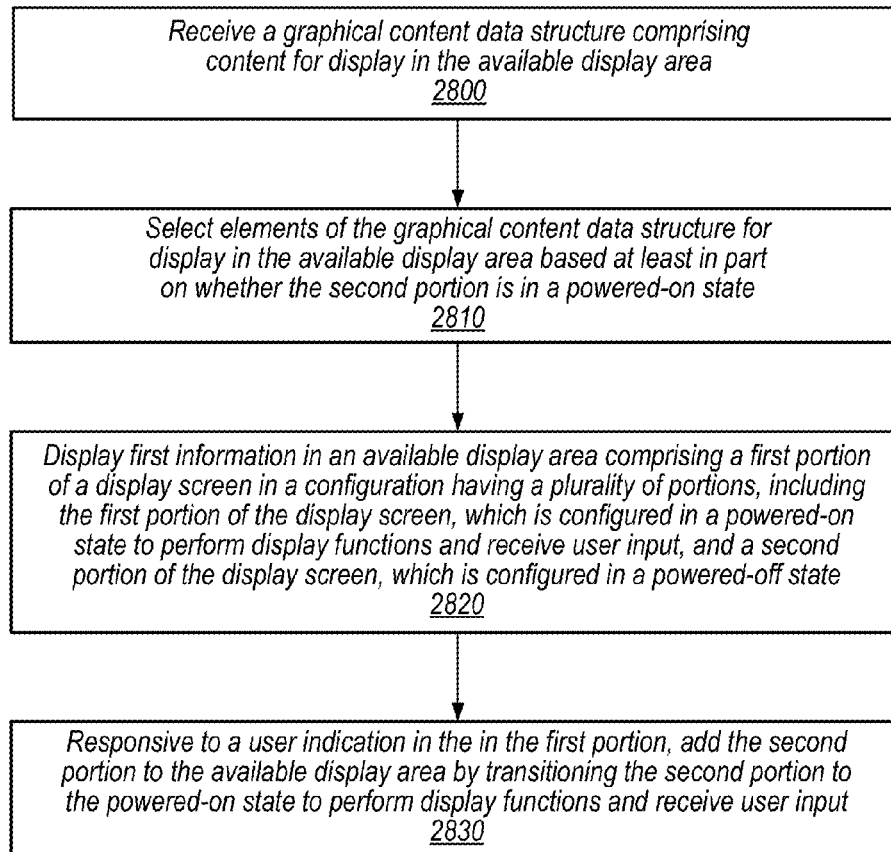

FIG. 28

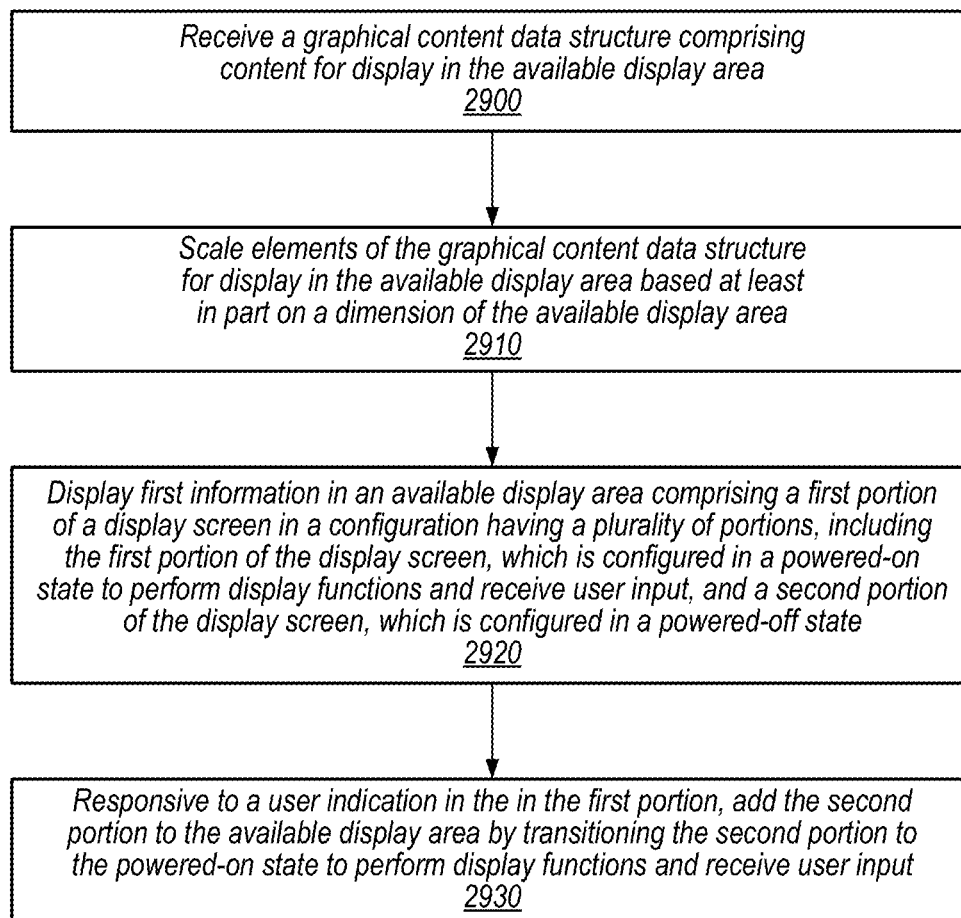

FIG. 29

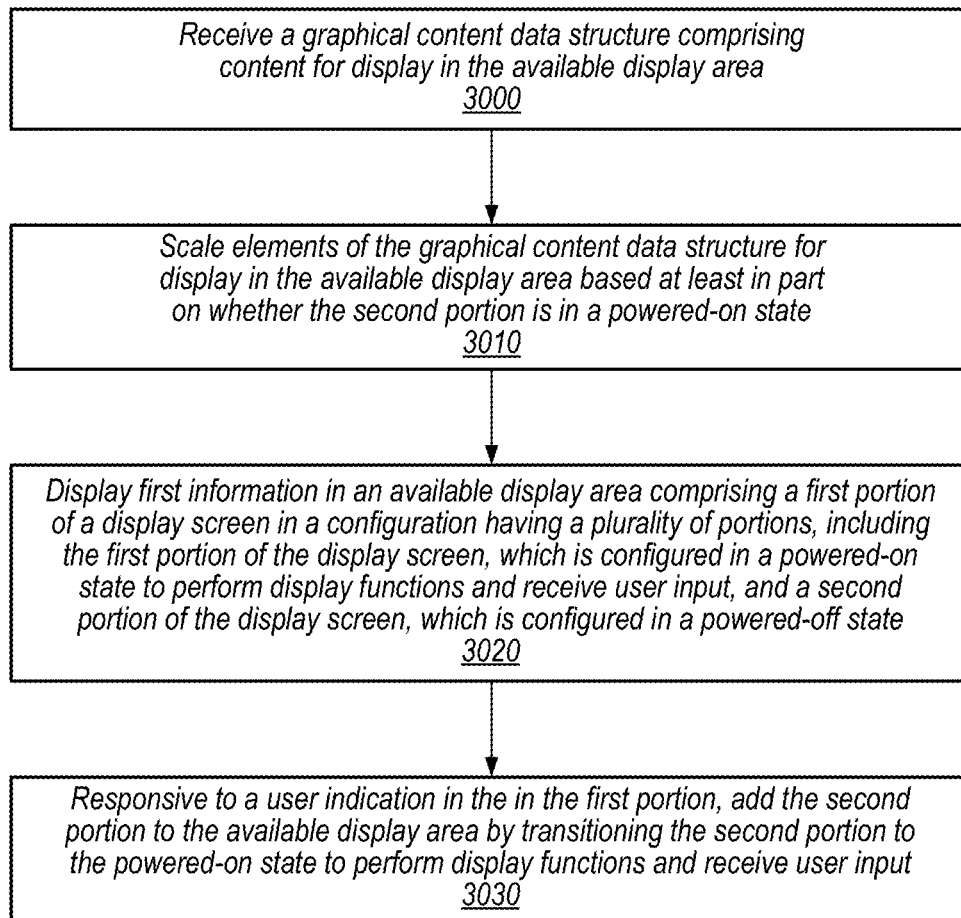

FIG. 30

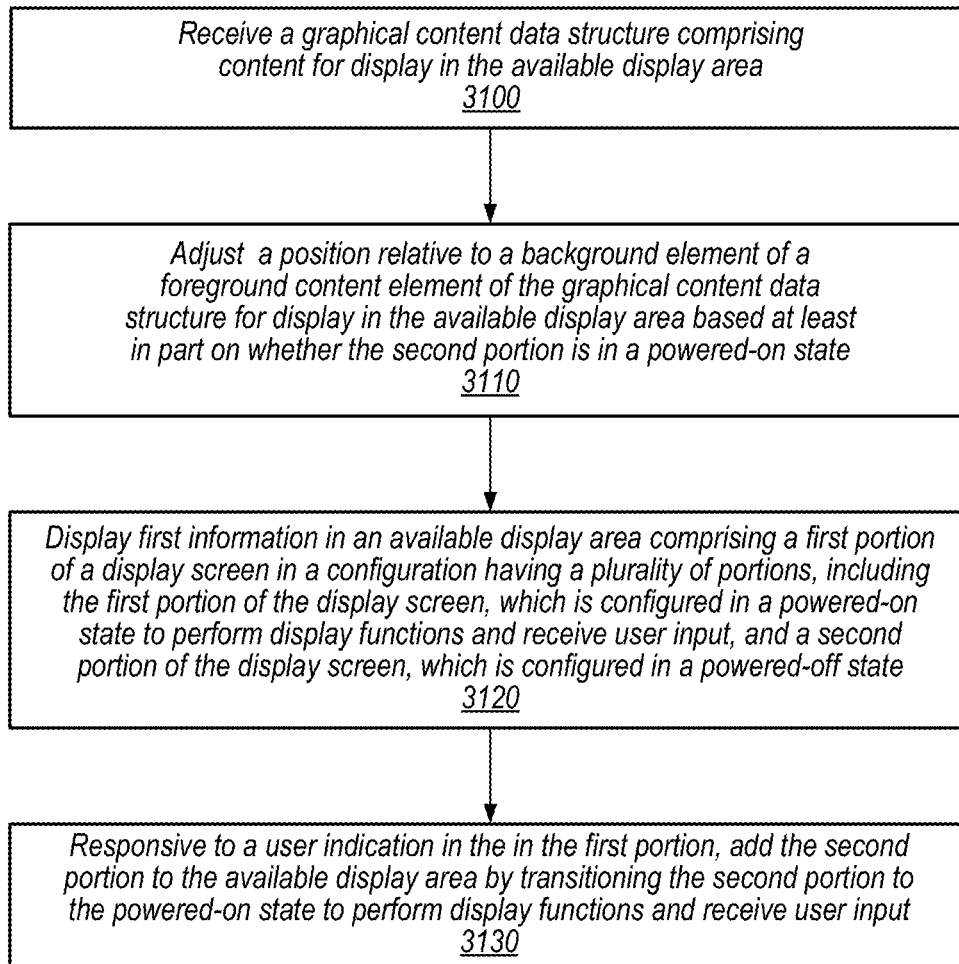

FIG. 31



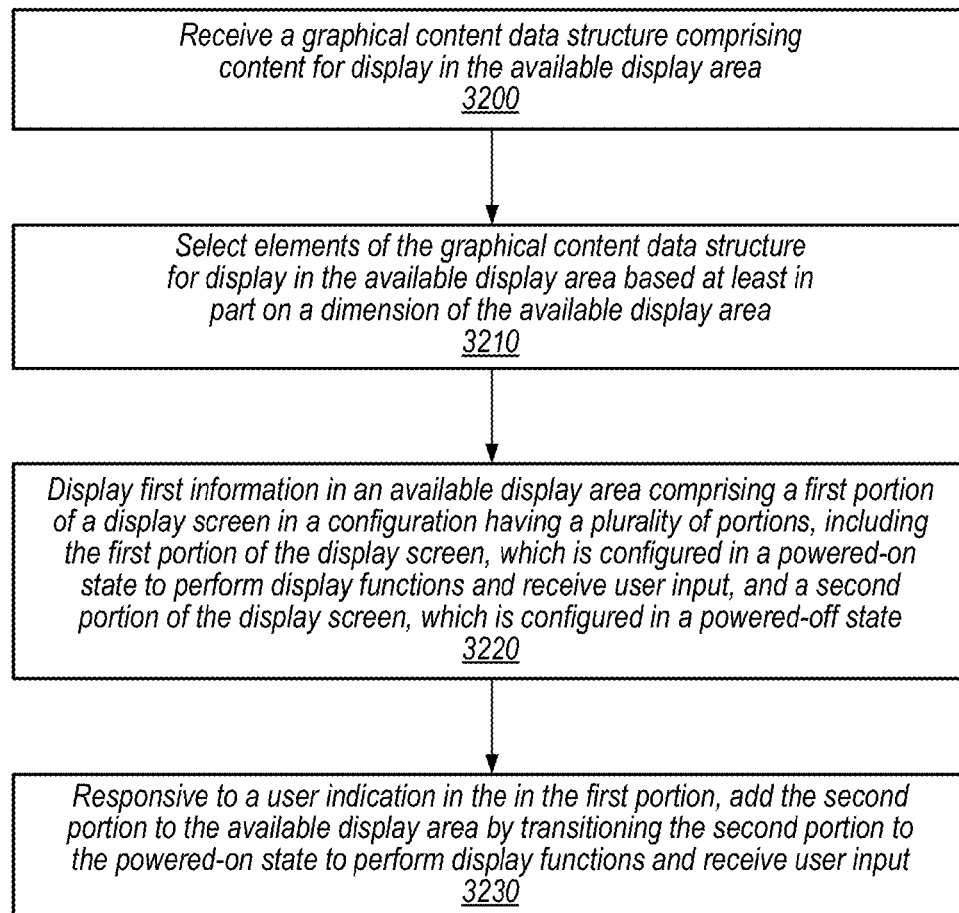

FIG. 32

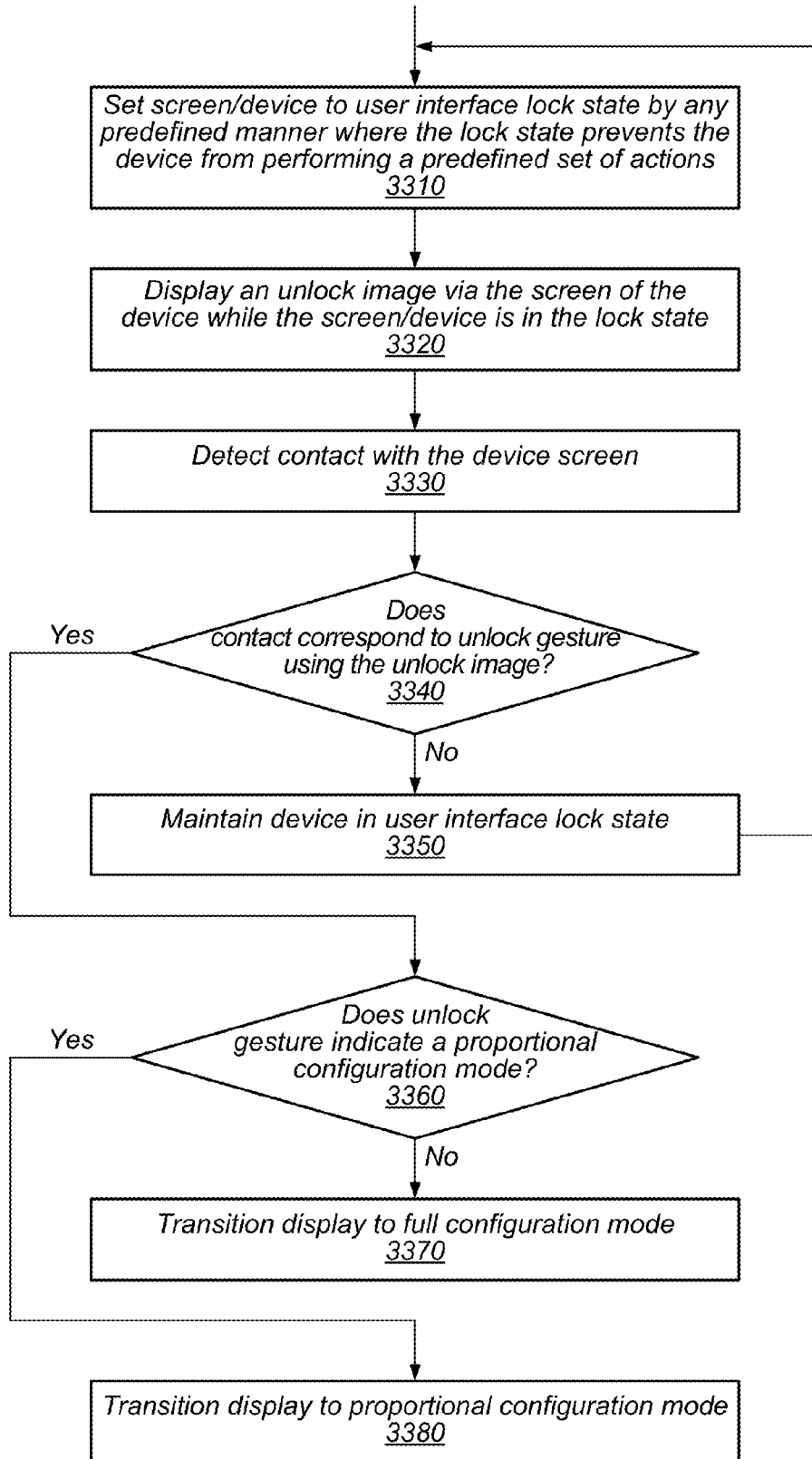

FIG. 33

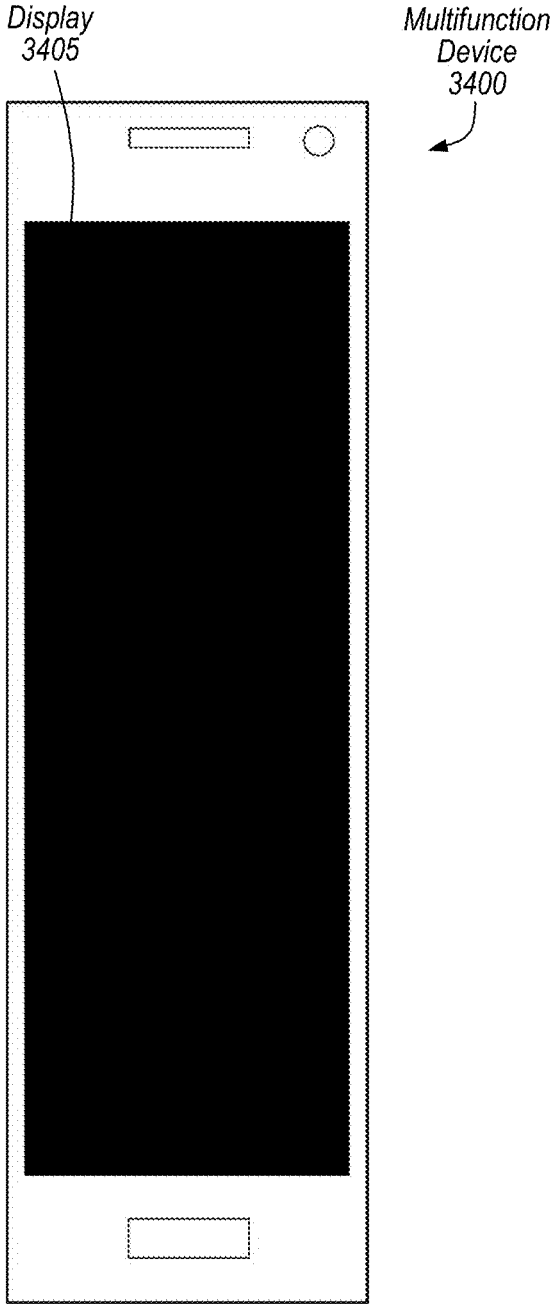

FIG. 34

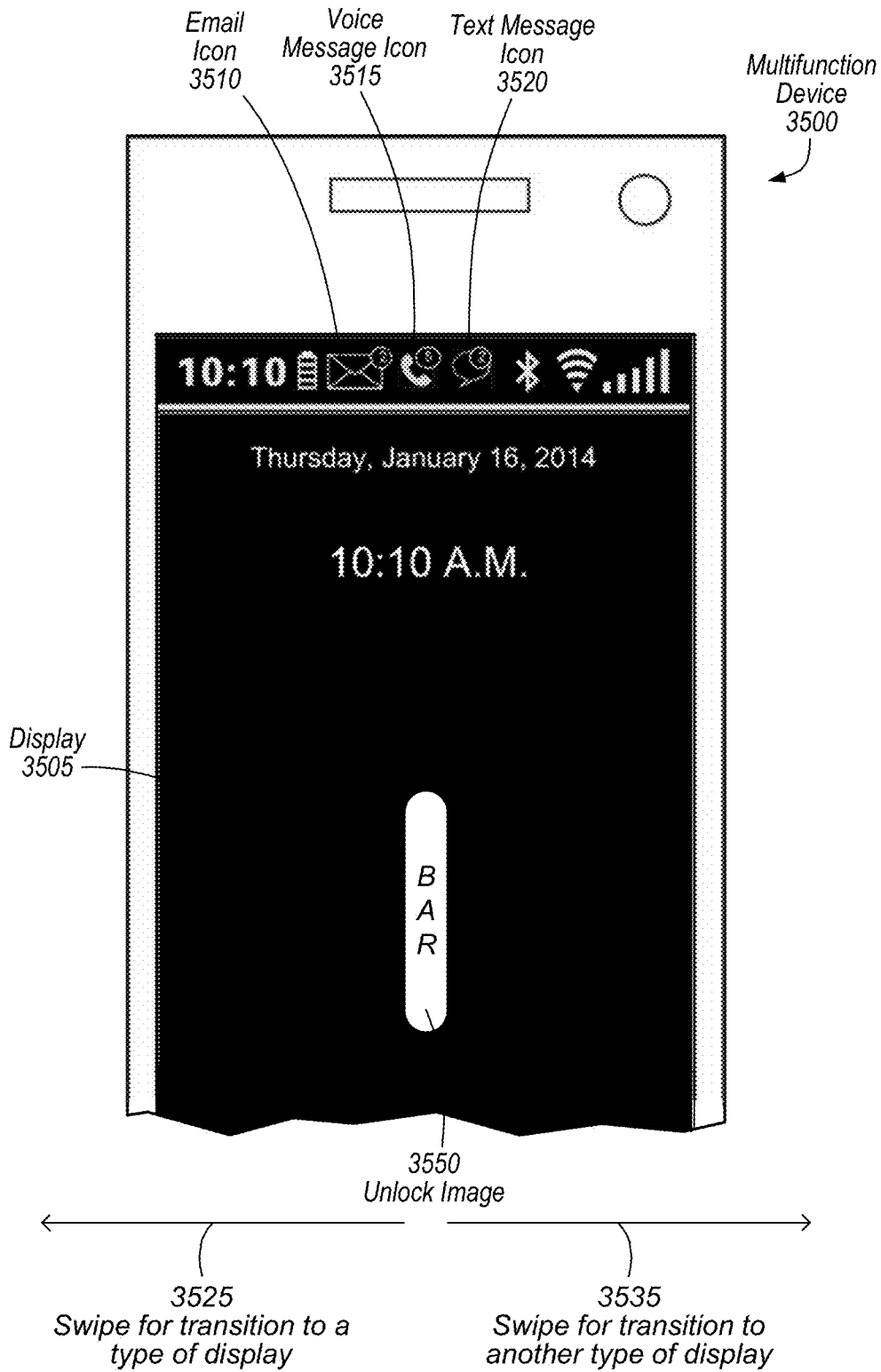

FIG. 35

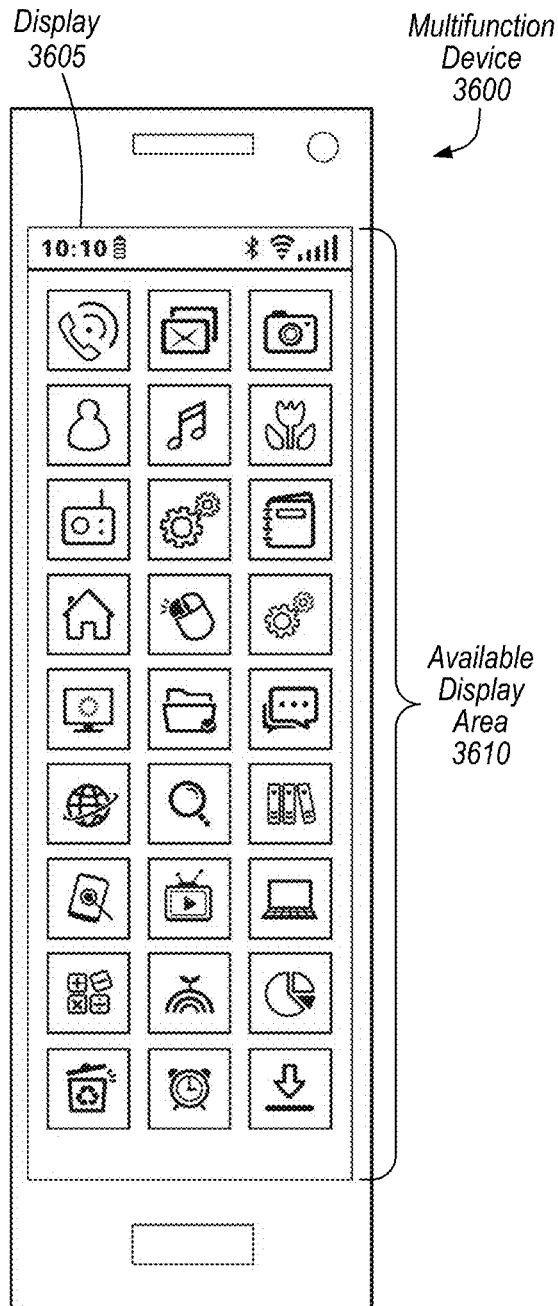

FIG. 36

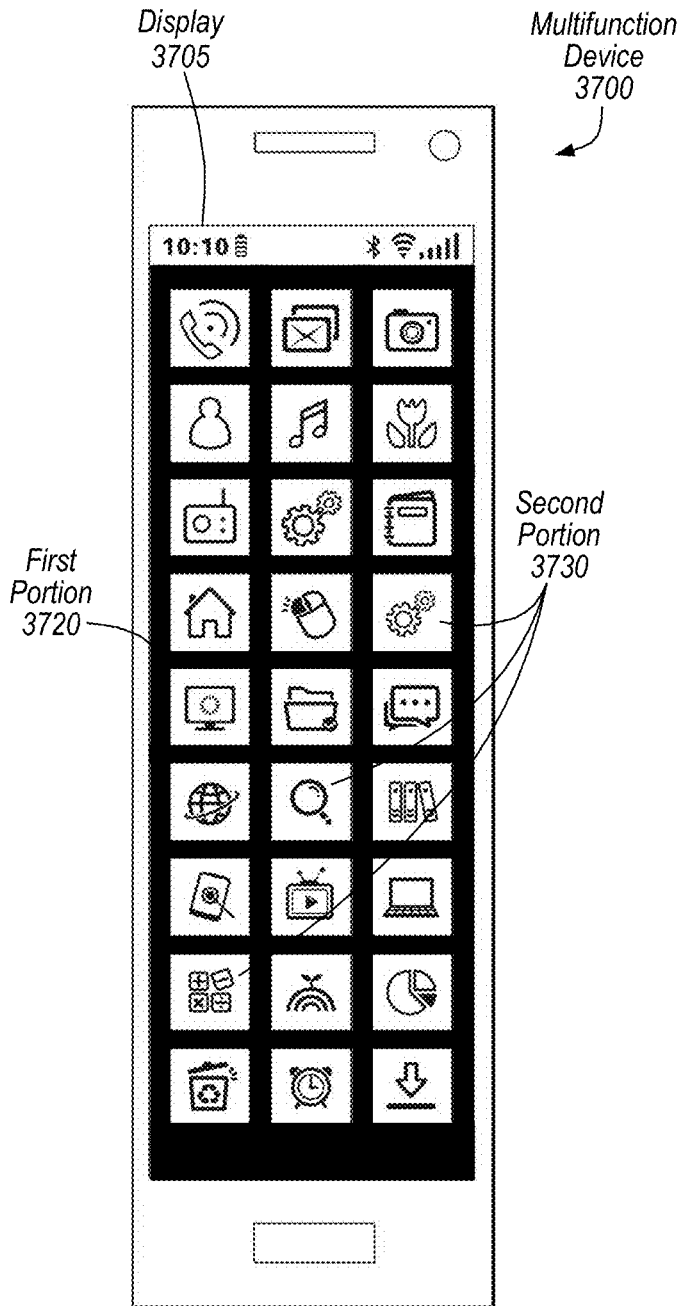

FIG. 37

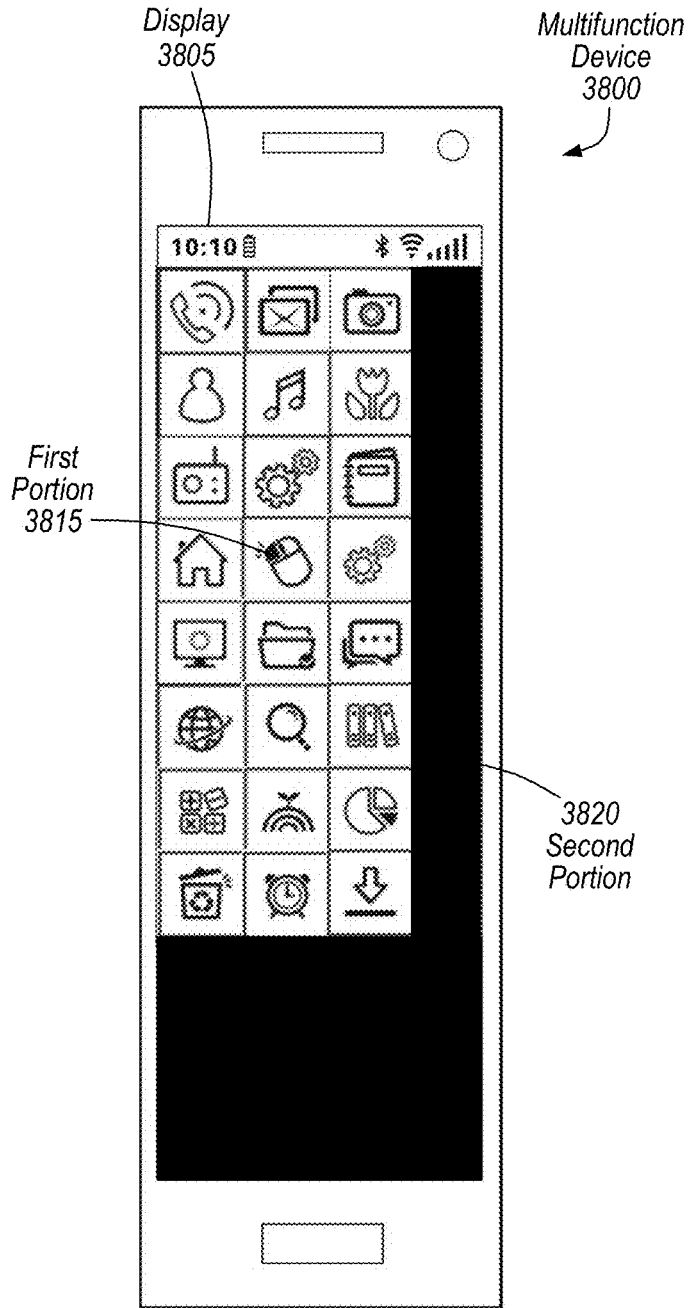

FIG. 38

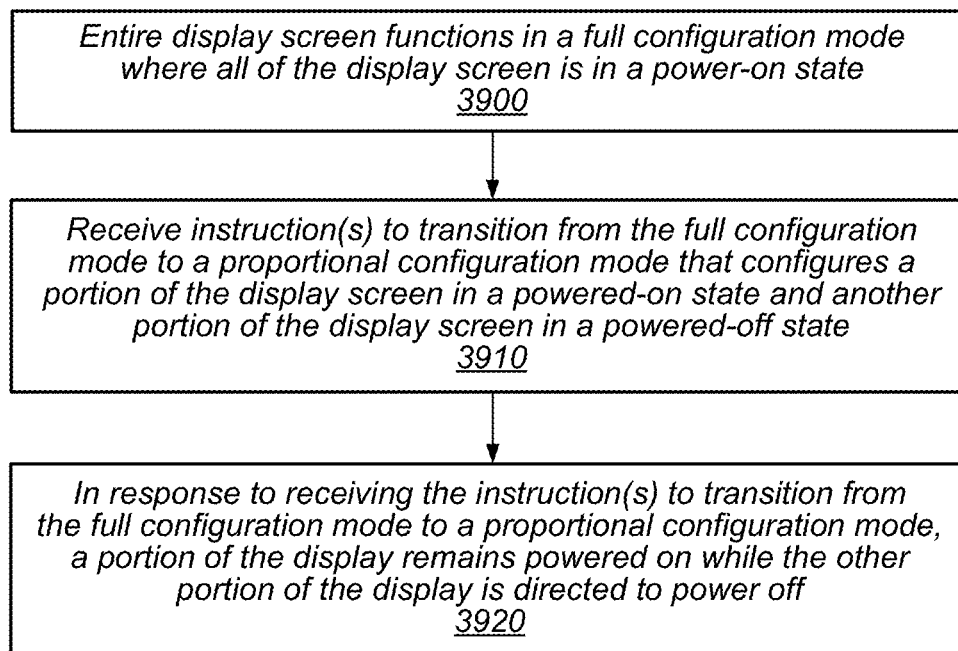

FIG. 39



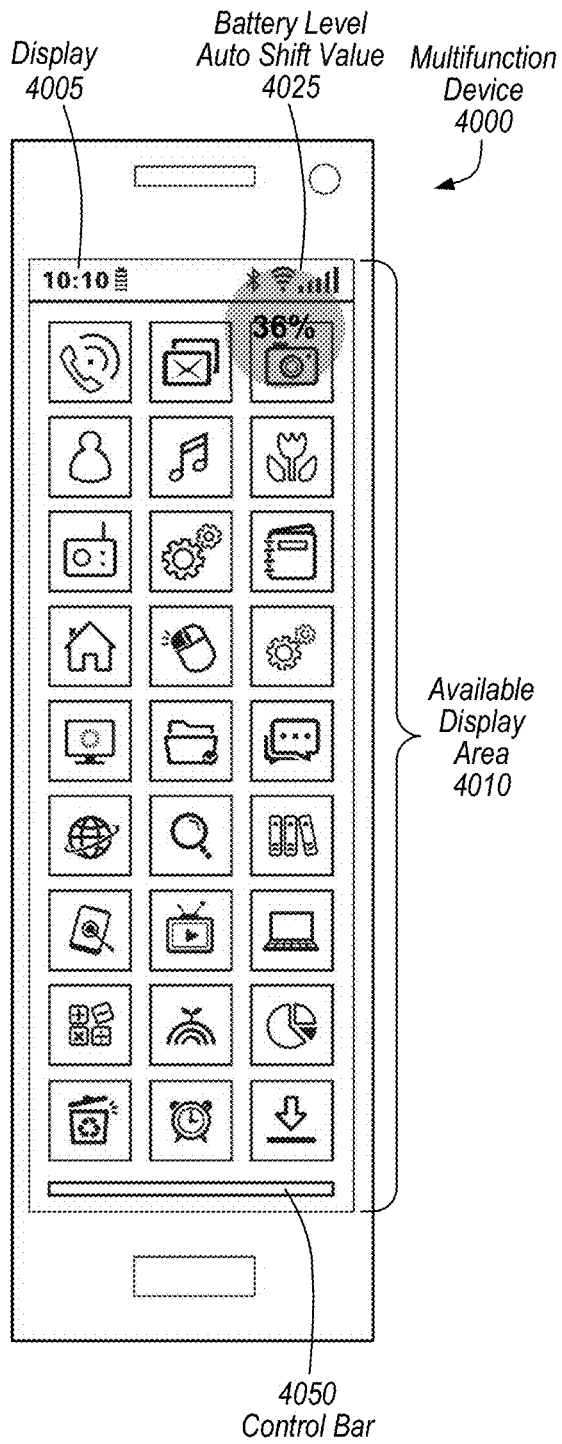

FIG. 40

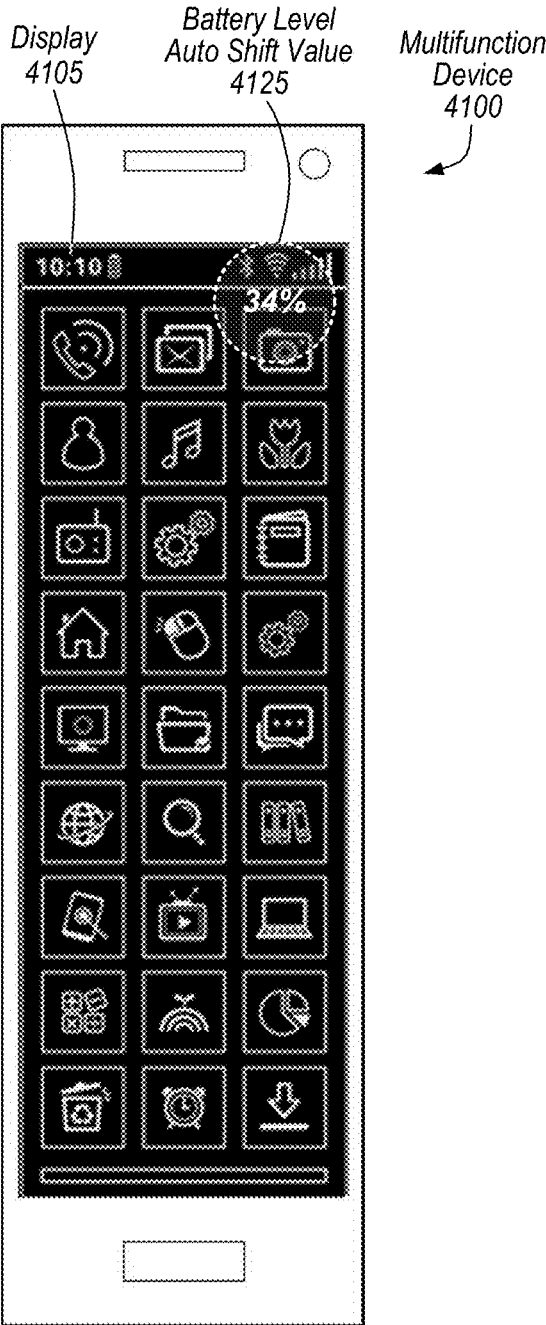

FIG. 41

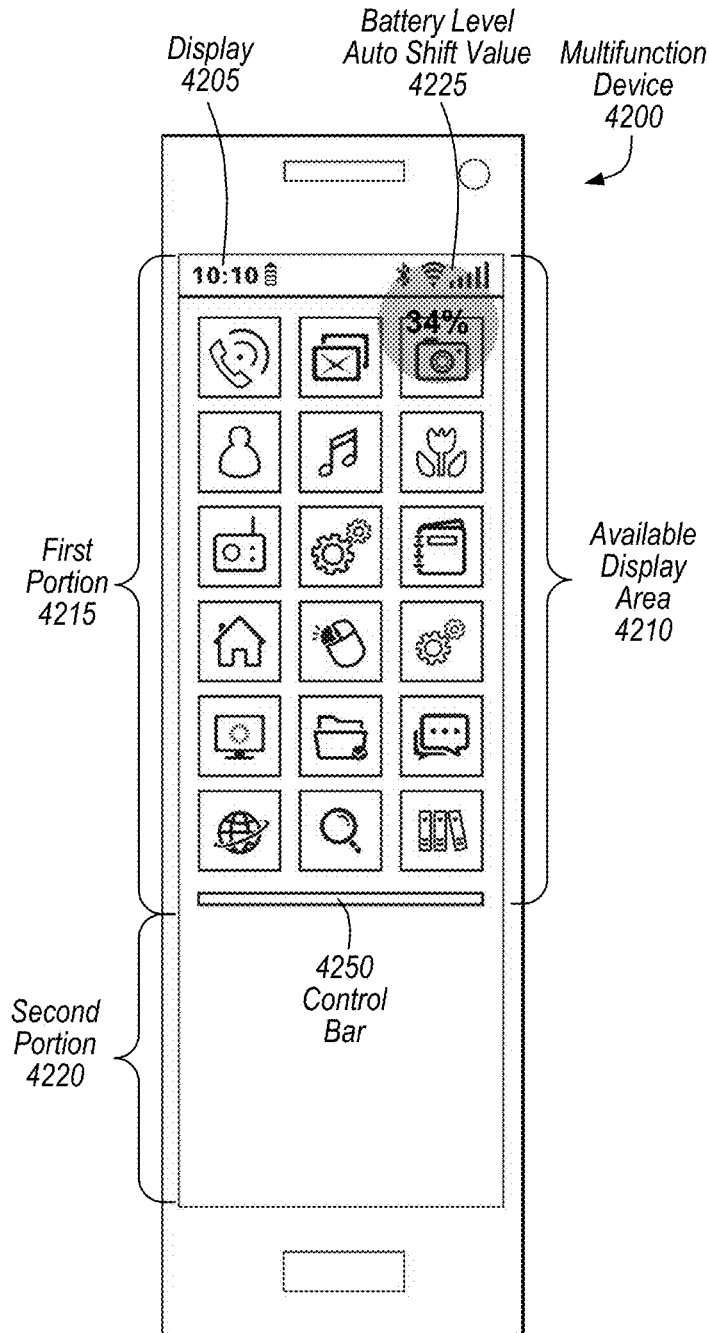

FIG. 42

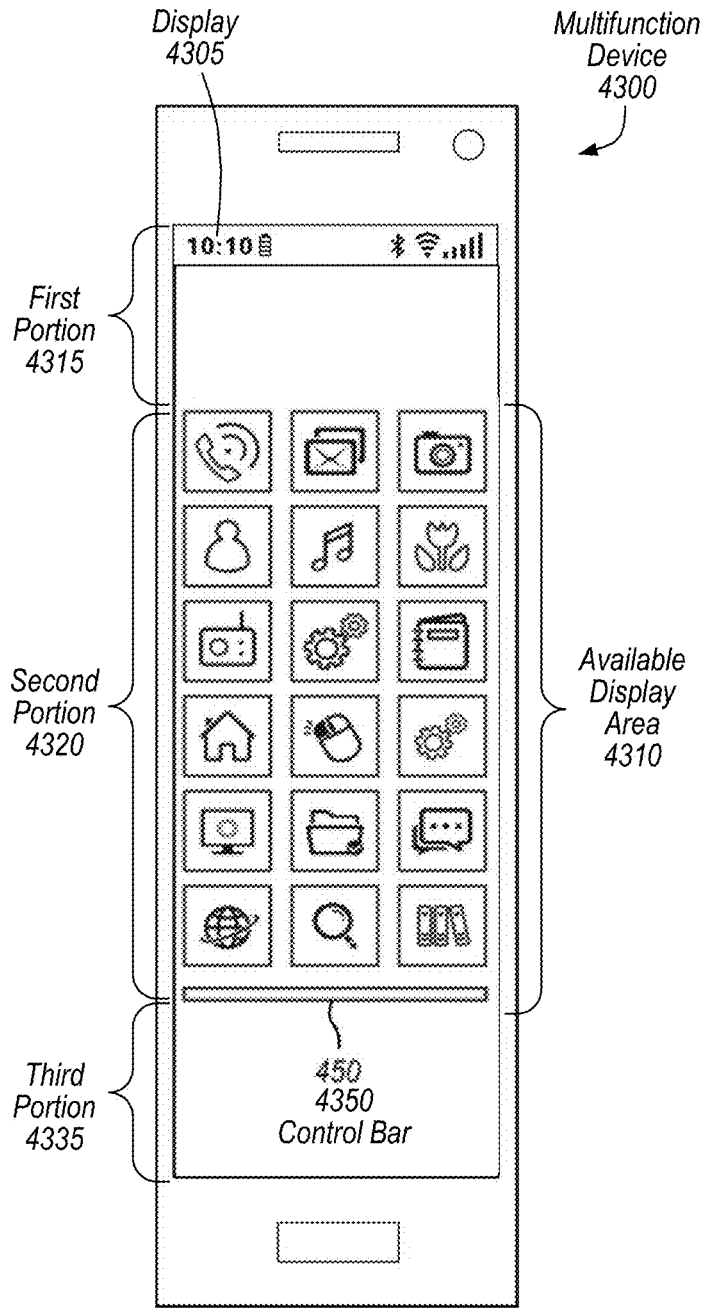

FIG. 43

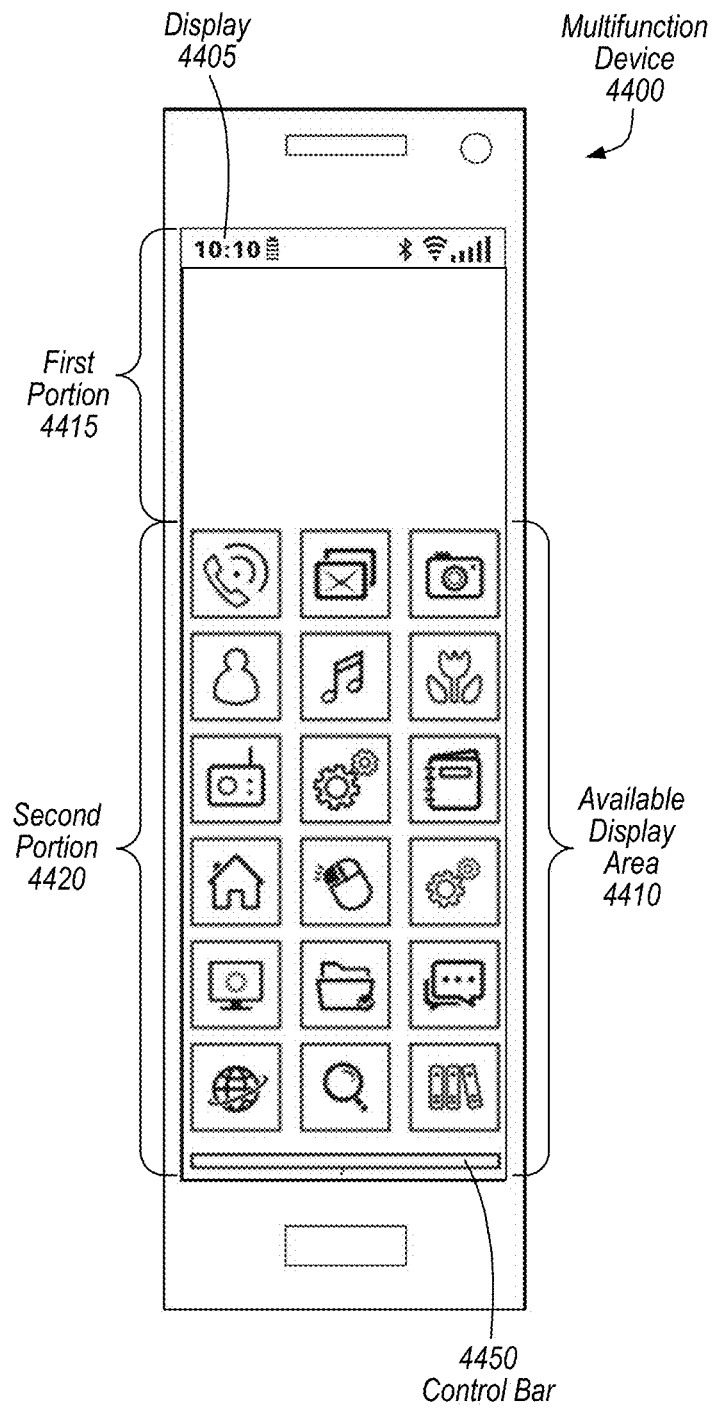

FIG. 44

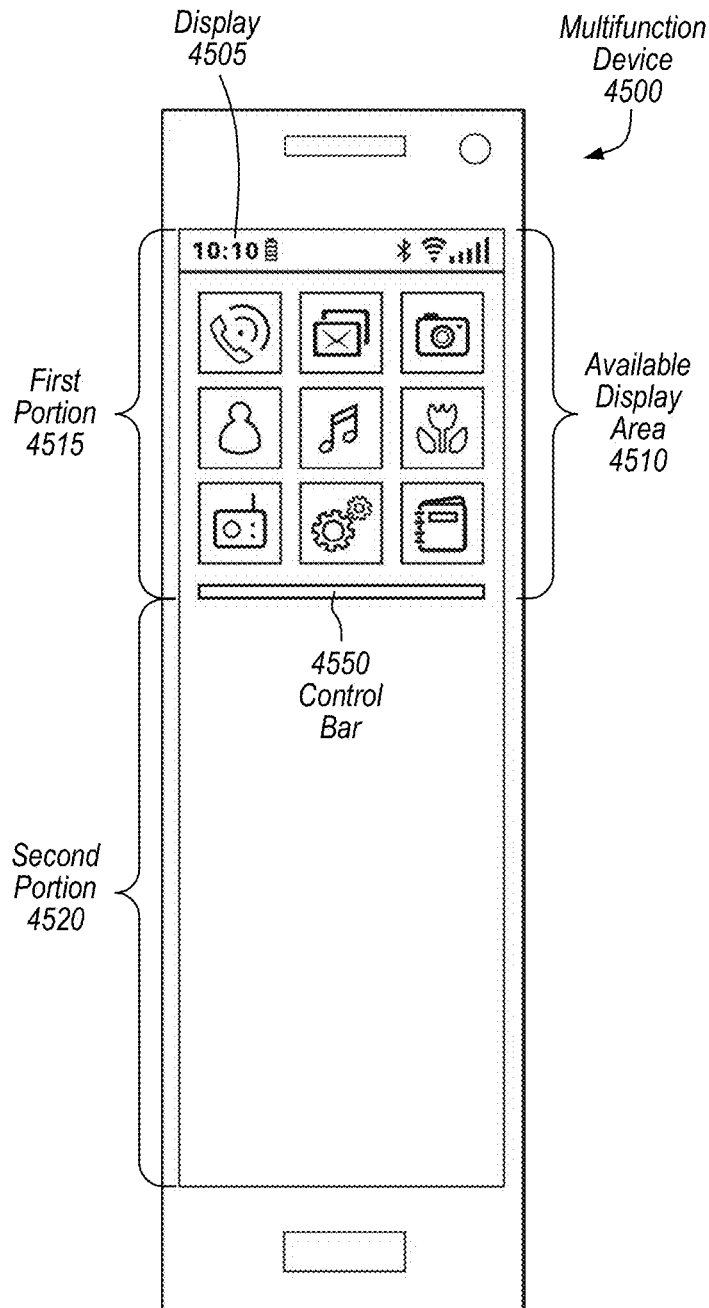

FIG. 45

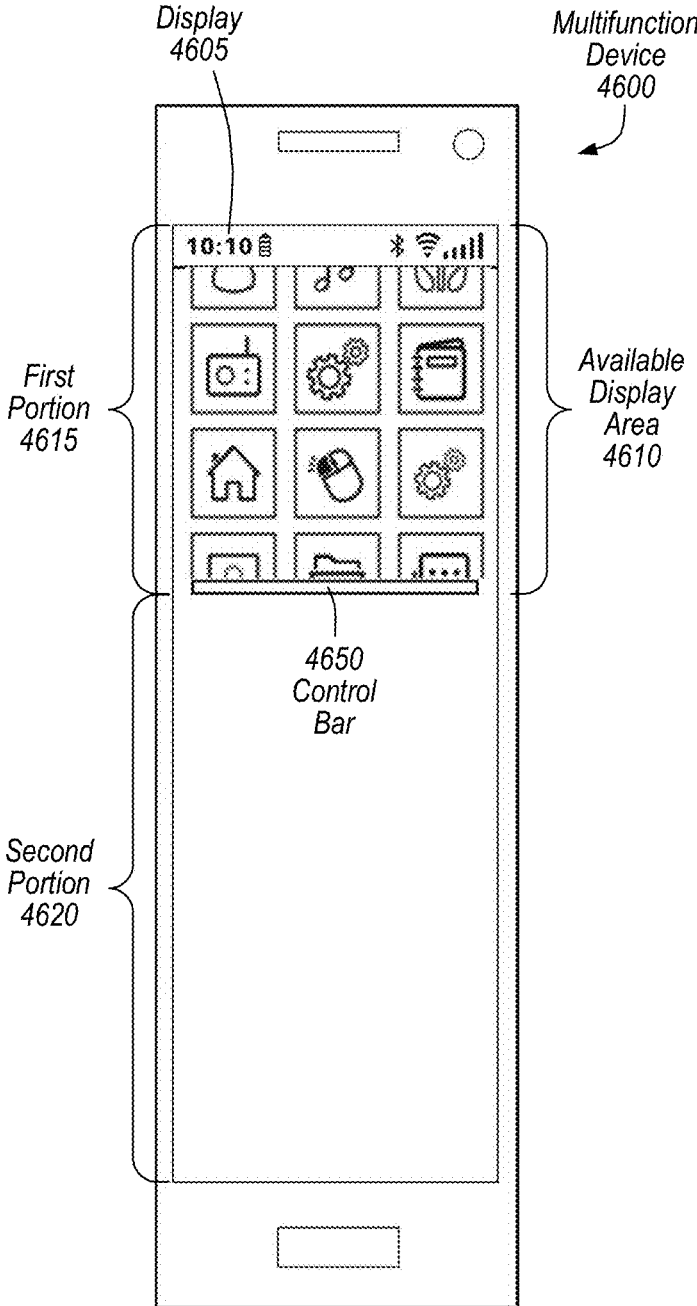

FIG. 46

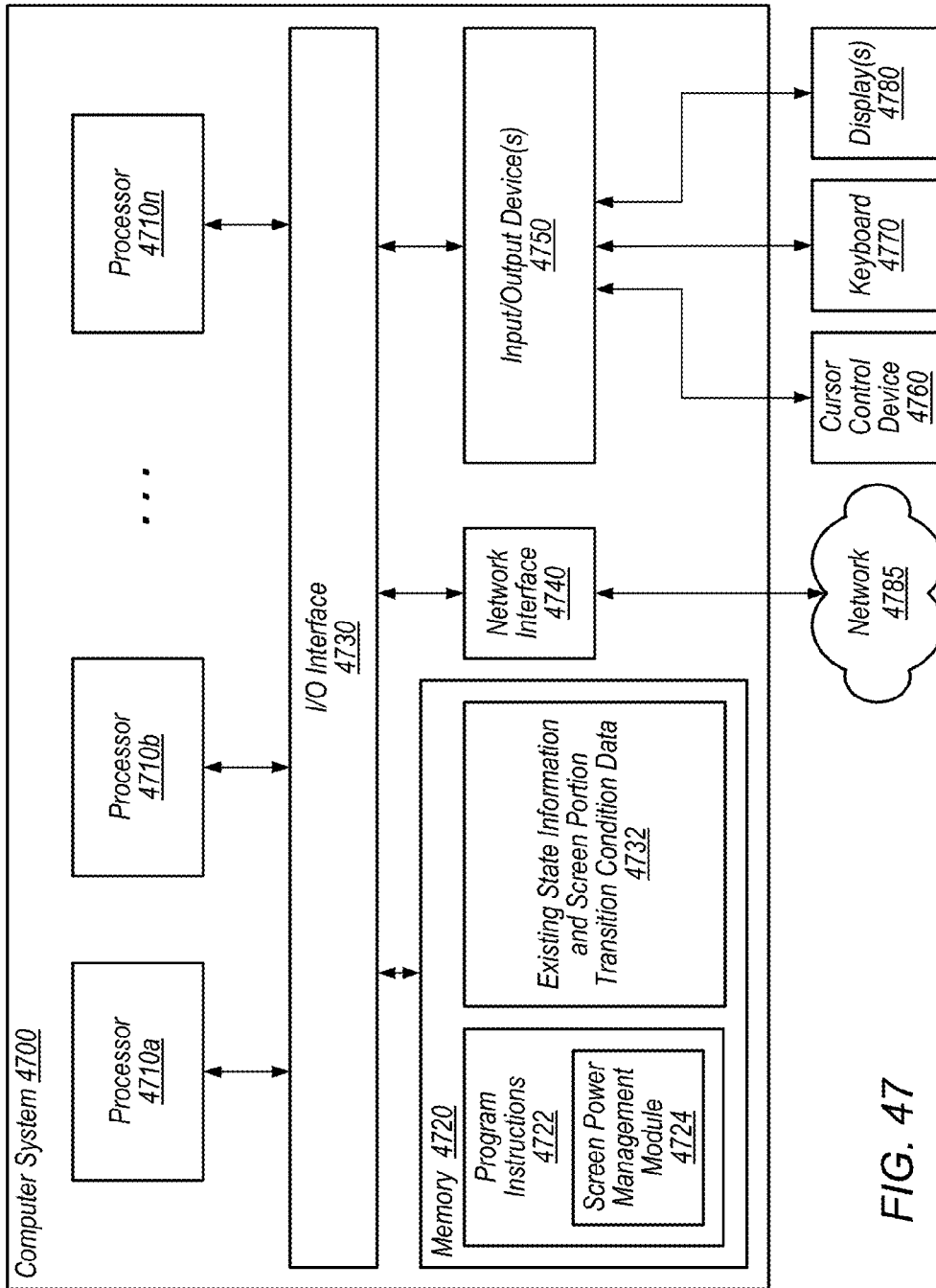

FIG. 47



## SYSTEM AND METHOD FOR MANAGING DISPLAY POWER CONSUMPTION

### PRIORITY

[0001] This application is a continuation-in-part of U.S. application Ser. No. 14/058,731, filed Oct. 21, 2013, which is continuation of U.S. application Ser. No. 13/905,064, filed May 29, 2013, which claims benefit of priority of U.S. Provisional Application Ser. No. 61/822,267, filed 10 May 2013, the contents of which are incorporated by reference herein in their entirety.

[0002] This application further claims benefit of priority of U.S. Provisional Application Ser. No. 61/826,673, entitled "System and Method for Managing Display Power Consumption," filed May 23, 2013, the content of which is incorporated by reference herein in its entirety.

### BACKGROUND

[0003] 1. Technical Field

[0004] This disclosure relates generally to power management, and, more specifically, to managing power consumption in display systems.

[0005] 2. Description of the Related Art

[0006] The revolution in mobile computing devices, also described herein as multifunction devices, has progressed at a far greater pace than the progress of the batteries that power mobile devices. From smart phones to tablets to laptops, users face increasing frustration as batteries drain under the ceaseless consumption produced by modern display devices.

[0007] As the multifunction devices improve and provide an increasingly sophisticated array of functions to the user, demand for power increases on two fronts. First, the amount of time that devices are in use increases. Second, improved hardware such as brighter display screens and faster processors drains more battery power for each minute that the multifunction device remains in use.

[0008] Most, if not all multifunction devices (e.g., smart phones) have a constant screen size and a display area with two options only; this is, the devices are either in a full display state (e.g., the entire display screen is powered on) or in a no display state where the entire display screen is powered-off.

### SUMMARY OF EMBODIMENTS

[0009] Systems and methods for managing display power consumption are disclosed. In some embodiments, screen space configuration and user or automated management of the display may cause portions of the display as well as elements displayed by the display to be configured to any user-selected size or position. The battery-saving benefit resulting from this new empowerment may be an extremely valuable function, in some embodiments.

[0010] In some embodiments first information is displayed in an available display area including a first portion of a display screen in a configuration having a set of portions. The set of portions includes the first portion of the display screen, which is configured in a powered-on state to perform display functions and receive user input, and a second portion of the display screen, which is configured in a powered-off state. Responsive to a user indication in the first portion, the second portion is added to the available display area by transitioning the second portion to the powered-on state to perform display functions and receive user input. Second information is displayed in the second portion.

[0011] According to some embodiments, an entire device display screen may function in a full configuration mode where the entire available display screen is in a power-on state. For example, a powered-on state may cause the affected part of the display to perform display functions and receive user input, although less, other or different functionality may be associated with the powered-on state. Instructions may be received directing the display to transition from the full configuration mode to a proportional configuration mode. The proportional configuration mode may configure a portion of the display screen in the powered-on state and another portion of the display in a powered-off state (in an example powered-off state, the affected part of the display may be configured to not perform display functions and to not receive user input). Responsive to receiving the instructions, the underlying display technology (e.g., OLED/AMOLED or LCD, etc.) may be directed to continue to power the portion of the display and power-off the other portion of the display.

[0012] In another embodiment, a device may be set to a user interface lock state by any predefined manner where the state prevents the device from performing a predefined set of actions. The device may be configured to display an unlock image while in the lock state and detect contact with a touch sensitive display. The device may be configured to determine whether the contact corresponds to an unlock gesture using the unlock image and further configured to determine whether the gesture indicates a proportional configuration mode or a full configuration mode. Responsive to the determination(s) the display may transition to the determined configuration mode.

### BRIEF DESCRIPTION OF THE DRAWINGS

[0013] FIG. 1 illustrates a block diagram of a portable multifunction device in accordance with some embodiments.

[0014] FIG. 2 illustrates a portable multifunction device in accordance with some embodiments.

[0015] FIG. 3 illustrates a portable multifunction displaying first information in an available display area comprising a first portion of a display screen device in accordance with some embodiments.

[0016] FIG. 4 depicts a portable multifunction responsive to a user indication in the in the first portion, adding the second portion to the available display area by transitioning the second portion to the powered-on state to perform display functions and receive user input, and displaying second information in the second portion in accordance with some embodiments.

[0017] FIG. 5 illustrates a portable multifunction displaying first information in an available display area comprising a first portion of a display screen device in accordance with some embodiments.

[0018] FIG. 6 depicts a portable multifunction responsive to a user indication in the in the first portion, adding the second portion to the available display area by transitioning the second portion to the powered-on state to perform display functions and receive user input, and displaying second information in the second portion in accordance with some embodiments.

[0019] FIG. 7 illustrates a portable multifunction displaying first information in an available display area comprising a first portion of a display screen device in accordance with some embodiments.

[0020] FIG. 8 depicts a portable multifunction responsive to a user indication in the in the first portion, adding the

second portion to the available display area by transitioning the second portion to the powered-on state to perform display functions and receive user input, and displaying second information in the second portion in accordance with some embodiments.

[0021] FIG. 9 illustrates a portable multifunction displaying first information in an available display area comprising a first portion of a display screen device in accordance with some embodiments.

[0022] FIG. 10 depicts a portable multifunction responsive to a user indication in the in the first portion, adding the second portion to the available display area by transitioning the second portion to the powered-on state to perform display functions and receive user input, and displaying second information in the second portion in accordance with some embodiments.

[0023] FIG. 11 illustrates a portable multifunction displaying first information in an available display area comprising a first portion of a display screen device in accordance with some embodiments.

[0024] FIG. 12 depicts a portable multifunction displaying first information in an available display area comprising a first portion of a display screen device in accordance with some embodiments.

[0025] FIG. 13 illustrates a portable multifunction responsive to a user indication in the in the first portion, adding the second portion to the available display area by transitioning the second portion to the powered-on state to perform display functions and receive user input, and displaying second information in the second portion in accordance with some embodiments.

[0026] FIG. 14 depicts a portable multifunction displaying with a display screen device in accordance with some embodiments.

[0027] FIG. 15 illustrates a portable multifunction displaying with a display screen device in accordance with some embodiments.

[0028] FIG. 16 depicts a portable multifunction displaying first information in an available display area comprising a first portion of a display screen device in accordance with some embodiments.

[0029] FIG. 17 illustrates a portable multifunction responsive to a user indication in the in the first portion, adding the second portion to the available display area by transitioning the second portion to the powered-on state to perform display functions and receive user input, and displaying second information in the second portion in accordance with some embodiments.

[0030] FIG. 18 depicts a portable multifunction responsive to a user indication in the in the first portion, adding the second portion to the available display area by transitioning the second portion to the powered-on state to perform display functions and receive user input, and displaying second information in the second portion in accordance with some embodiments.

[0031] FIG. 19 illustrates a portable multifunction displaying with a display screen device in accordance with some embodiments.

[0032] FIG. 19A illustrates a portable multifunction displaying with a display screen device in accordance with some embodiments.

[0033] FIG. 20 depicts a portable multifunction displaying with a display screen device in accordance with some embodiments.

[0034] FIG. 21 illustrates a portable multifunction displaying with a display screen device in accordance with some embodiments.

[0035] FIG. 22 depicts a portable multifunction displaying with a display screen device in accordance with some embodiments.

[0036] FIG. 23 illustrates a portable multifunction displaying with a display screen device in accordance with some embodiments.

[0037] FIG. 24 depicts a portable multifunction displaying with a display screen device in accordance with some embodiments.

[0038] FIG. 25 illustrates a display power management module for managing display power consumption, according to some embodiments.

[0039] FIG. 26 is a flow diagram illustrating one embodiment of a method for managing display power consumption, according to some embodiments.

[0040] FIG. 27 is a flow diagram illustrating one embodiment of a method for managing display power consumption, according to some embodiments.

[0041] FIG. 28 is a flow diagram illustrating one embodiment of a method for managing display power consumption, according to some embodiments.

[0042] FIG. 29 is a flow diagram illustrating one embodiment of a method for managing display power consumption, according to some embodiments.

[0043] FIG. 30 is a flow diagram illustrating one embodiment of a method for managing display power consumption, according to some embodiments.

[0044] FIG. 31 is a flow diagram illustrating one embodiment of a method for managing display power consumption, according to some embodiments.

[0045] FIG. 32 is a flow diagram illustrating one embodiment of a method for managing display power consumption, according to some embodiments.

[0046] FIG. 33 is a flow diagram illustrating an embodiment of a method for unlocking a display and transitioning the display into either a full configuration mode or a proportional configuration mode.

[0047] FIG. 34 illustrates a portable multifunction with a display screen in accordance with some embodiments.

[0048] FIG. 35 illustrates a portion of a portable multifunction with a display screen in accordance with some embodiments.

[0049] FIG. 36 illustrates a portable multifunction with a display screen in accordance with some embodiments.

[0050] FIG. 37 illustrates a portable multifunction with a display screen in accordance with some embodiments.

[0051] FIG. 38 illustrates a portable multifunction with a display screen in accordance with some embodiments.

[0052] FIG. 39 is a flow diagram illustrating an embodiment of a method for transitioning a display from a full configuration mode to a proportional configuration mode.

[0053] FIG. 40 illustrates a portable multifunction with a display screen in accordance with some embodiments.

[0054] FIG. 41 illustrates a portable multifunction with a display screen in accordance with some embodiments.

[0055] FIG. 42 illustrates a portable multifunction with a display screen in accordance with some embodiments.

[0056] FIG. 43 illustrates a portable multifunction with a display screen in accordance with some embodiments.

[0057] FIG. 44 illustrates a portable multifunction with a display screen in accordance with some embodiments.

**[0058]** FIG. 45 illustrates a portable multifunction with a display screen in accordance with some embodiments.

**[0059]** FIG. 46 illustrates a portable multifunction with a display screen in accordance with some embodiments.

**[0060]** FIG. 47 illustrates an example computer system configured to implement aspects of the system and method for managing display power consumption.

**[0061]** This specification includes references to “one embodiment” or “an embodiment.” The appearances of the phrases “in one embodiment” or “in an embodiment” do not necessarily refer to the same embodiment. Particular features, structures, or characteristics may be combined in any suitable manner consistent with this disclosure.

**[0062]** “Comprising.” This term is open-ended. As used in the appended claims, this term does not foreclose additional structure or steps. Consider a claim that recites: “An apparatus comprising one or more processor units . . .” Such a claim does not foreclose the apparatus from including additional components (e.g., a network interface unit, graphics circuitry, etc.).

**[0063]** “Configured To.” Various units, circuits, or other components may be described or claimed as “configured to” perform a task or tasks. In such contexts, “configured to” is used to connote structure by indicating that the units/circuits/components include structure (e.g., circuitry) that performs those task or tasks during operation. As such, the unit/circuit/component can be said to be configured to perform the task even when the specified unit/circuit/component is not currently operational (e.g., is not on). The units/circuits/components used with the “configured to” language include hardware—for example, circuits, memory storing program instructions executable to implement the operation, etc. Reciting that a unit/circuit/component is “configured to” perform one or more tasks is expressly intended not to invoke 35 U.S.C. §112, sixth paragraph, for that unit/circuit/component. Additionally, “configured to” can include generic structure (e.g., generic circuitry) that is manipulated by software and/or firmware (e.g., an FPGA or a general-purpose processor executing software) to operate in manner that is capable of performing the task(s) at issue. “Configure to” may also include adapting a manufacturing process (e.g., a semiconductor fabrication facility) to fabricate devices (e.g., integrated circuits) that are adapted to implement or perform one or more tasks.

**[0064]** “First,” “Second,” etc. As used herein, these terms are used as labels for nouns that they precede, and do not imply any type of ordering (e.g., spatial, temporal, logical, etc.). For example, a buffer circuit may be described herein as performing write operations for “first” and “second” values. The terms “first” and “second” do not necessarily imply that the first value must be written before the second value.

**[0065]** “Based On.” As used herein, this term is used to describe one or more factors that affect a determination. This term does not foreclose additional factors that may affect a determination. That is, a determination may be solely based on those factors or based, at least in part, on those factors. Consider the phrase “determine A based on B.” While in this case, B is a factor that affects the determination of A, such a phrase does not foreclose the determination of A from also being based on C. In other instances, A may be determined based solely on B.

## DETAILED DESCRIPTION

### Introduction

**[0066]** Various embodiments of a system and method for managing display power consumption are disclosed. According to some embodiments, an entire device display screen may function in a full configuration mode where the entire available display screen is in a power-on state. For example, a powered-on state may cause the affected part of the display to perform display functions and receive user input, although less, other or different functionality may be associated with the powered-on state. Instructions may be received directing the display to transition from the full configuration mode to a proportional configuration mode. The proportional configuration mode may configure a portion of the display screen in the powered-on state and another portion of the display in a powered-off state (in an example powered-off state, the affected part of the display may be configured to not perform display functions and to not receive user input). Responsive to receiving the instructions, the underlying display technology (e.g., pixels for OLED/AMOLED technologies) may be directed to continue to power the portion of the display and power-off the other portion of the display.

**[0067]** In some embodiments, the portion of the screen (e.g., some or all of the display) that is powered-off may be black or near-black, unresponsive to the touch, or display other characteristics of a display that is not powered. For example, the portion of the display that is powered-off cannot be activated by an errant finger and may be used as a handle for gripping the device. Such configuration may be useful for tasks such as taking pictures with the device comprising the display. The portion of the display that is powered-off may be configurable by or for the user and the rest of the display may continue to provide all or almost all of the full functionality, as described herein.

**[0068]** The screen may be the constant total surface area of the multifunction device on which graphics or text may be electronically provided (or “displayed”), in some embodiments. A display may be configured to display (e.g., illuminate one or more pixels) one or more colors (e.g., other than a black, or other color screen that is the color of the display when powered off) when powered-on, for example. The area of the display that is powered-on may range from 0% (e.g., all black/off) to 100% (e.g., a full display) and anywhere in-between. In some embodiments, the display may be configured to display in grayscale.

**[0069]** 0% to 100% of the display or screen may be configured as powered-on, in embodiments. Whatever portion is not configured as powered-on may be configured as powered-off. In embodiments, the portion that is configured as powered-off may be using little to no power from the battery. In embodiments, multiple different portions of the screen may be configured as powered-on while the rest of the screen remains powered-off. For example, the icons representing applications on a smart phone user interface may be powered-on while the space in-between the icons may be powered-off, like islands of powered-on color in a sea of powered-off display area. The display portion may be equal to the total surface area of the sum of the individual powered-on display areas divided by the total screen size.

**[0070]** The portion of powered-on display may be user-configurable, via settings or manipulation of the user-interface, such as described herein, for example. In another example, the portion of powered-on display may be otherwise

controlled, by the device operating system or by an application. Embodiments, as described herein, may reduce the amount of screen that is powered-on (e.g., from 20-plus applications to half that or less). In some embodiment, such a configuration may reduce the use of battery power.

**[0071]** In some embodiments, power efficiency may be improved by practicing the methods and configurations described herein, providing for extended battery life for example. A device comprising a display as described herein may provide a user with the ability to control the size of the display such that individual pixels below the powered-off or inactive (e.g., black/dead/unpowered) portion of the display screen are all turned off (e.g., in smart phones using OLED/AMOLED technologies) in embodiments. Some tests have shown that for some devices, something like 67% of the total power drain of a battery may be attributable to the display. In embodiments, the power drain reduction may be proportional to the size of the powered-off portion

**[0072]** In another embodiment, a device may be set to a user interface lock state by any predefined manner where the state prevents the device from performing a predefined set of actions. The device may be configured to display an unlock image while in the lock state and detect contact with a touch sensitive display. The device may be configured to determine whether the contact corresponds to an unlock gesture using the unlock image and further configured to determine whether the gesture indicates a proportional configuration mode or a full configuration mode. Responsive to the determination(s) the display may transition to the determined configuration mode.

**[0073]** In some embodiments first information is displayed in an available display area including a first portion of a display screen in a configuration having a plurality of portions. In some embodiments, the display screen includes the first portion of the display screen, which is configured in a powered-on state to perform display functions and receive user input, and a second portion of the display screen, which is configured in a powered-off state. Responsive to a user indication in the in the first portion, the second portion is added to the available display area by transitioning the second portion to the powered-on state to perform display functions and receive user input. Second information is displayed in the second portion.

**[0074]** The process may be reversible in some embodiments, and a portion of the display screen may be removed from the powered-on state to the powered off state in response to user input. Likewise, the actions described herein as being performed in response to user input may, in some embodiments, be performed in response to system events such as the passage of an amount of time or a signal from an application or system module, or other system events, such as a power-down or sleep signal.

**[0075]** Some embodiments include a redesign of the current user interface of smart phones and hand-held terminals, variously referred to herein as multifunction devices, giving the user the full freedom to touch change their screen and divide it into an active (working) portion and a non-active (non-working, dead) portion depending on their needs and application. Some embodiments achieve numerous valuable benefits such as extending existing battery usage time as a result of the unused electricity saved by the dead portion of the screen, and at the same time using the dead portion of the

screen as a grip surface to securely and conveniently use applications such as the camera (similar to the HandlePa™), etc.

**[0076]** Some embodiments present a new simple yet revolutionary user interface (UI) based on a concept and method which will elevate the user's freedom and flexibility and thus change the way smart phone and hand-held terminal users interact with their screen.

**[0077]** In some embodiments, the second information is generated by mathematically upscaling the first information. The second information includes a portion of the first information upscaled for display in both the second portion and the first portion. In some embodiments, third information in the first portion. The third information comprises a portion of the first information upscaled for display in both the second portion and the first portion. In some embodiments, a graphical content data structure including content for display in the available display area is received, and elements of the graphical content data structure are selected for display in the available display area based at least in part on whether the second portion is in a powered-on state.

**[0078]** In some embodiments, a graphical content data structure including content for display in the available display area is received, and elements of the graphical content data structure are scaled for display in the available display area based at least in part on a dimension of the available display area. In some embodiments, a graphical content data structure including content for display in the available display area is received, and elements of the graphical content data structure are scaled for display in the available display area based at least in part on whether the second portion is in a powered-on state.

**[0079]** In some embodiments, a graphical content data structure including content for display in the available display area is received, and a position relative to a background element of a foreground content element of the graphical content data structure is adjusted for display in the available display area based at least in part on whether the second portion is in a powered-on state. In some embodiments, a graphical content data structure including content for display in the available display area is received, and elements of the graphical content data structure are selected for display in the available display area based at least in part on a dimension of the available display area.

**[0080]** Some embodiments may include a means for managing display power consumption. For example, a screen power management module may display first information in an available display area comprising a first portion of a display screen in a configuration having a plurality of portions, responsive to a user indication in the in the first portion, add the second portion to the available display area by transitioning the second portion to the powered-on state to perform display functions and receive user input, and display second information in the second portion, as described herein. The screen power management module may in some embodiments be implemented by a non-transitory, computer-readable storage medium and one or more processors (e.g., CPUs and/or GPUs) of a computing apparatus. The computer-readable storage medium may store program instructions executable by the one or more processors to cause the computing apparatus to display first information in an available display area comprising a first portion of a display screen in a configuration having a plurality of portions, responsive to a user indication in the in the first portion, add the second portion to

the available display area by transitioning the second portion to the powered-on state to perform display functions and receive user input, and display second information in the second portion, as described herein. Other embodiments of a screen power management module may be at least partially implemented by hardware circuitry and/or firmware stored, for example, in a non-volatile memory.

#### Multifunction Device

**[0081]** Reference will now be made in detail to embodiments, examples of which are illustrated in the accompanying drawings. In the following detailed description, numerous specific details are set forth in order to provide a thorough understanding of the present disclosure. However, it will be apparent to one of ordinary skill in the art that some embodiments may be practiced without these specific details. In other instances, well-known methods, procedures, components, circuits, and networks have not been described in detail so as not to unnecessarily obscure aspects of the embodiments.

**[0082]** It will also be understood that, although the terms first, second, etc. may be used herein to describe various elements, these elements should not be limited by these terms. These terms are only used to distinguish one element from another. For example, a first contact could be termed a second contact, and, similarly, a second contact could be termed a first contact, without departing from the intended scope. The first contact and the second contact are both contacts, but they are not the same contact.

**[0083]** The terminology used in the description herein is for the purpose of describing particular embodiments only and is not intended to be limiting. As used in the description and the appended claims, the singular forms “a”, “an” and “the” are intended to include the plural forms as well, unless the context clearly indicates otherwise. It will also be understood that the term “and/or” as used herein refers to and encompasses any and all possible combinations of one or more of the associated listed items. It will be further understood that the terms “includes,” “including,” “comprises,” and/or “comprising,” when used in this specification, specify the presence of stated features, integers, steps, operations, elements, and/or components, but do not preclude the presence or addition of one or more other features, integers, steps, operations, elements, components, and/or groups thereof.

**[0084]** As used herein, the term “if” may be construed to mean “when” or “upon” or “in response to determining” or “in response to detecting,” depending on the context. Similarly, the phrase “if it is determined” or “if [a stated condition or event] is detected” may be construed to mean “upon determining” or “in response to determining” or “upon detecting [the stated condition or event]” or “in response to detecting [the stated condition or event],” depending on the context.

**[0085]** Embodiments of electronic devices, user interfaces for such devices, and associated processes for using such devices are described. In some embodiments, the device is a portable communications device, such as a mobile telephone, that also contains other functions, such as PDA and/or music player functions. Other portable electronic devices, such as laptops or tablet computers with touch-sensitive surfaces (e.g., touch screen displays and/or touch pads), may also be used. It should also be understood that, in some embodiments, the device is not a portable communications device, but is a desktop computer with a touch-sensitive surface (e.g., a touch screen display and/or a touch pad). In some embodiments, the

device is a gaming computer with orientation sensors (e.g., orientation sensors in a gaming controller).

**[0086]** In the discussion that follows, an electronic device that includes a display and a touch-sensitive surface is described. It should be understood, however, that the electronic device may include one or more other physical user-interface devices, such as a physical keyboard, a mouse and/or a joystick.

**[0087]** The device typically supports a variety of applications, such as one or more of the following: a drawing application, a presentation application, a word processing application, a website creation application, a disk authoring application, a spreadsheet application, a gaming application, a telephone application, a video conferencing application, an e-mail application, an instant messaging application, a work-out support application, a photo management application, a digital camera application, a digital video camera application, a web browsing application, a digital music player application, and/or a digital video player application.

**[0088]** The various applications that may be executed on the device may use at least one common physical user-interface device, such as the touch-sensitive surface. One or more functions of the touch-sensitive surface as well as corresponding information displayed on the device may be adjusted and/or varied from one application to the next and/or within a respective application. In this way, a common physical architecture (such as the touch-sensitive surface) of the device may support the variety of applications with user interfaces that are intuitive and transparent to the user.

**[0089]** Attention is now directed toward embodiments of portable devices. FIG. 1 is a block diagram illustrating portable multifunction device **100** with touch-sensitive displays **112** in accordance with some embodiments. Touch-sensitive display **112** is sometimes called a “touch screen” for convenience, and may also be known as or called a touch-sensitive display system. Device **100** may include memory **102** (which may include one or more computer readable storage mediums), memory controller **122**, one or more processing units (CPU’s) **120**, peripherals interface **118**, RF circuitry **108**, audio circuitry **110**, speaker **111**, microphone **113**, input/output (I/O) subsystem **106**, other input or control devices **116**, and external port **124**. Device **100** may include one or more optical sensors **164**. These components may communicate over one or more communication buses or signal lines **103**.

**[0090]** It should be appreciated that device **100** is only one example of a portable multifunction device, and that device **100** may have more or fewer components than shown, may combine two or more components, or may have a different configuration or arrangement of the components. The various components shown in FIG. 1 may be implemented in hardware, software, or a combination of hardware and software, including one or more signal processing and/or application specific integrated circuits.

**[0091]** Memory **102** may include high-speed random access memory and may also include non-volatile memory, such as one or more magnetic disk storage devices, flash memory devices, or other non-volatile solid-state memory devices. Access to memory **102** by other components of device **100**, such as CPU **120** and the peripherals interface **118**, may be controlled by memory controller **122**.

**[0092]** Peripherals interface **118** can be used to couple input and output peripherals of the device to CPU **120** and memory **102**. The one or more processors **120** run or execute

various software programs and/or sets of instructions stored in memory 102 to perform various functions for device 100 and to process data.

**[0093]** In some embodiments, peripherals interface 118, CPU 120, and memory controller 122 may be implemented on a single chip, such as chip 104. In some other embodiments, they may be implemented on separate chips.

**[0094]** RF (radio frequency) circuitry 108 receives and sends RF signals, also called electromagnetic signals. RF circuitry 108 converts electrical signals to/from electromagnetic signals and communicates with communications networks and other communications devices via the electromagnetic signals. RF circuitry 108 may include well-known circuitry for performing these functions, including but not limited to an antenna system, an RF transceiver, one or more amplifiers, a tuner, one or more oscillators, a digital signal processor, a CODEC chipset, a subscriber identity module (SIM) card, memory, and so forth. RF circuitry 108 may communicate with networks, such as the Internet, also referred to as the World Wide Web (WWW), an intranet and/or a wireless network, such as a cellular telephone network, a wireless local area network (LAN) and/or a metropolitan area network (MAN), and other devices by wireless communication.

**[0095]** The wireless communication may use any of a variety of communications standards, protocols and technologies, including but not limited to Global System for Mobile Communications (GSM), Enhanced Data GSM Environment (EDGE), high-speed downlink packet access (HSDPA), high-speed uplink packet access (HSUPA), wideband code division multiple access (W-CDMA), code division multiple access (CDMA), time division multiple access (TDMA), Bluetooth, Wireless Fidelity (Wi-Fi) (e.g., IEEE 802.11a, IEEE 802.11b, IEEE 802.11g and/or IEEE 802.11n), voice over Internet Protocol (VoIP), Wi-MAX, a protocol for e-mail (e.g., Internet message access protocol (IMAP) and/or post office protocol (POP)), instant messaging (e.g., extensible messaging and presence protocol (XMPP), Session Initiation Protocol for Instant Messaging and Presence Leveraging Extensions (SIMPLE), Instant Messaging and Presence Service (IMPS)), and/or Short Message Service (SMS), or any other suitable communication protocol, including communication protocols not yet developed as of the filing date of this document.

**[0096]** Audio circuitry 110, speaker 111, and microphone 113 provide an audio interface between a user and device 100. Audio circuitry 110 receives audio data from peripherals interface 118, converts the audio data to an electrical signal, and transmits the electrical signal to speaker 111. Speaker 111 converts the electrical signal to human-audible sound waves. Audio circuitry 110 also receives electrical signals converted by microphone 113 from sound waves. Audio circuitry 110 converts the electrical signal to audio data and transmits the audio data to peripherals interface 118 for processing. Audio data may be retrieved from and/or transmitted to memory 102 and/or RF circuitry 108 by peripherals interface 118. In some embodiments, audio circuitry 110 also includes a headset jack (e.g., 212, FIG. 2). The headset jack provides an interface between audio circuitry 110 and removable audio input/output peripherals, such as output-only headphones or a headset with both output (e.g., a headphone for one or both ears) and input (e.g., a microphone).

**[0097]** I/O subsystem 106 couples input/output peripherals on device 100, such as touch screen 112 and other input

control devices 116, to peripherals interface 118. I/O subsystem 106 may include display controller 156 and one or more input controllers 160 for other input or control devices. The one or more input controllers 160 receive/send electrical signals from/to other input or control devices 116. The other input control devices 116 may include physical buttons (e.g., push buttons, rocker buttons, etc.), dials, slider switches, joysticks, click wheels, and so forth. In some alternate embodiments, input controller(s) 160 may be coupled to any (or none) of the following: a keyboard, infrared port, USB port, and a pointer device such as a mouse. The one or more buttons (e.g., 208, FIG. 2) may include an up/down button for volume control of speaker 111 and/or microphone 113. The one or more buttons may include a push button (e.g., 206, FIG. 2).

**[0098]** Touch-sensitive display 112 provides an input interface and an output interface between the device and a user. Display controller 156 receives and/or sends electrical signals from/to touch screen 112. Touch screen 112 displays visual output to the user. The visual output may include graphics, text, icons, video, and any combination thereof (collectively termed "graphics"). In some embodiments, some or all of the visual output may correspond to user-interface objects.

**[0099]** Touch screen 112 has a touch-sensitive surface, sensor or set of sensors that accepts input from the user based on haptic and/or tactile contact. Touch screen 112 and display controller 156 (along with any associated modules and/or sets of instructions in memory 102) detect contact (and any movement or breaking of the contact) on touch screen 112 and converts the detected contact into interaction with user-interface objects (e.g., one or more soft keys, icons, web pages or images) that are displayed on touch screen 112. In an exemplary embodiment, a point of contact between touch screen 112 and the user corresponds to a finger of the user.

**[0100]** Touch screen 112 may use LCD (liquid crystal display) technology, LPD (light emitting polymer display) technology, or LED (light emitting diode) technology, although other display technologies may be used in other embodiments. Touch screen 112 and display controller 156 may detect contact and any movement or breaking thereof using any of a variety of touch sensing technologies now known or later developed, including but not limited to capacitive, resistive, infrared, and surface acoustic wave technologies, as well as other proximity sensor arrays or other elements for determining one or more points of contact with touch screen 112. In an exemplary embodiment, projected mutual capacitance sensing technology is used, such as that found in the iPhone®, iPod Touch®, and iPad® from Apple Inc. of Cupertino, Calif.

**[0101]** The user may make contact with touch screen 112 using any suitable object or appendage, such as a stylus, a finger, and so forth. In some embodiments, the user interface is designed to work primarily with finger-based contacts and gestures, which can be less precise than stylus-based input due to the larger area of contact of a finger on the touch screen. In some embodiments, the device translates the rough finger-based input into a precise pointer/cursor position or command for performing the actions desired by the user.

**[0102]** In some embodiments, in addition to the touch screen, device 100 may include a touchpad (not shown) for activating or deactivating particular functions. In some embodiments, the touchpad is a touch-sensitive area of the device that, unlike the touch screen, does not display visual output. The touchpad may be a touch-sensitive surface that is separate from touch screen 112 or an extension of the touch-sensitive surface formed by the touch screen.

[0103] Device 100 also includes power system 162 for powering the various components. Power system 162 may include a power management system, one or more power sources (e.g., battery, alternating current (AC)), a recharging system, a power failure detection circuit, a power converter or inverter, a power status indicator (e.g., a light-emitting diode (LED)) and any other components associated with the generation, management and distribution of power in portable devices.

[0104] Device 100 may also include one or more optical sensors 164. FIG. 1 shows an optical sensor coupled to optical sensor controller 159 in I/O subsystem 106. Optical sensor 164 may include charge-coupled device (CCD) or complementary metal-oxide semiconductor (CMOS) phototransistors. Optical sensor 164 receives light from the environment, projected through one or more lens, and converts the light to data representing an image. In conjunction with imaging module 143 (also called a camera module) optical sensor 164 may capture still images or video. In some embodiments, an optical sensor is located on the back of device 100, opposite touch screen display 112 on the front of the device, so that the touch screen display may be used as a viewfinder for still and/or video image acquisition. In some embodiments, another optical sensor is located on the front of the device so that the user's image may be obtained for videoconferencing while the user views the other video conference participants on the touch screen display.

[0105] Device 100 may also include one or more proximity sensors 166. FIG. 1 shows proximity sensor 166 coupled to peripherals interface 118. Alternately, proximity sensor 166 may be coupled to input controller 160 in I/O subsystem 106. In some embodiments, the proximity sensor turns off and disables touch screen 112 when the multifunction device is placed near the user's ear (e.g., when the user is making a phone call).

[0106] Device 100 includes one or more orientation sensors 168. In some embodiments, the one or more orientation sensors include one or more accelerometers (e.g., one or more linear accelerometers and/or one or more rotational accelerometers). In some embodiments, the one or more orientation sensors include one or more gyroscopes. In some embodiments, the one or more orientation sensors include one or more magnetometers. In some embodiments, the one or more orientation sensors include one or more of global positioning system (GPS), Global Navigation Satellite System (GLONASS), and/or other global navigation system receivers. The GPS, GLONASS, and/or other global navigation system receivers may be used for obtaining information concerning the location and orientation (e.g., portrait or landscape) of device 100. In some embodiments, the one or more orientation sensors include any combination of orientation/rotation sensors. FIG. 1 shows the one or more orientation sensors 168 coupled to peripherals interface 118. Alternately, the one or more orientation sensors 168 may be coupled to an input controller 160 in I/O subsystem 106. In some embodiments, information is displayed on the touch screen display in a portrait view or a landscape view based on an analysis of data received from the one or more orientation sensors.

[0107] In some embodiments, the software components stored in memory 102 include operating system 126, communication module (or set of instructions) 128, contact/motion module (or set of instructions) 130, graphics module (or set of instructions) 132, text input module (or set of instructions) 134, Global Positioning System (GPS) module (or set of

instructions) 135, screen power management module 158 and applications (or sets of instructions) 136. Device/global internal state 157 includes one or more of: active application state, indicating which applications, if any, are currently active; display state, indicating what applications, views or other information occupy various regions of touch screen display 112; sensor state, including information obtained from the device's various sensors and input control devices 116; state information that indicates which processes control output of shared audio or visual resource of a vehicle; ownership transition conditions of the shared audio or visual resource; and location information concerning the device's location and/or attitude.

[0108] Operating system 126 (e.g., Darwin, LINUX, UNIX, OS X, WINDOWS, or an embedded operating system such as VxWorks or RTXC) includes various software components and/or drivers for controlling and managing general system tasks (e.g., memory management, storage device control, power management, etc.) and facilitates communication between various hardware and software components.

[0109] Communication module 128 facilitates communication with other devices over one or more external ports 124 and also includes various software components for handling data received by RF circuitry 108 and/or external port 124. External port 124 (e.g., Universal Serial Bus (USB), FIREWIRE, etc.) is adapted for coupling directly to other devices or indirectly over a network (e.g., the Internet, wireless LAN, etc.).

[0110] Contact/motion module 130 may detect contact with touch screen 112 (in conjunction with display controller 156) and other touch sensitive devices (e.g., a touchpad or physical click wheel). Contact/motion module 130 includes various software components for performing various operations related to detection of contact, such as determining if contact has occurred (e.g., detecting a finger-down event), determining if there is movement of the contact and tracking the movement across the touch-sensitive surface (e.g., detecting one or more finger-dragging events), and determining if the contact has ceased (e.g., detecting a finger-up event or a break in contact). Contact/motion module 130 receives contact data from the touch-sensitive surface. Determining movement of the point of contact, which is represented by a series of contact data, may include determining speed (magnitude), velocity (magnitude and direction), and/or an acceleration (a change in magnitude and/or direction) of the point of contact. These operations may be applied to single contacts (e.g., one finger contacts) or to multiple simultaneous contacts (e.g., "multitouch"/multiple finger contacts). In some embodiments, contact/motion module 130 and display controller 156 detect contact on a touchpad.

[0111] Contact/motion module 130 may detect a gesture input by a user. Different gestures on the touch-sensitive surface have different contact patterns. Thus, a gesture may be detected by detecting a particular contact pattern. For example, detecting a finger tap gesture includes detecting a finger-down event followed by detecting a finger-up (lift off) event at the same position (or substantially the same position) as the finger-down event (e.g., at the position of an icon). As another example, detecting a finger swipe gesture on the touch-sensitive surface includes detecting a finger-down event followed by detecting one or more finger-dragging events, and subsequently followed by detecting a finger-up (lift off) event.

[0112] Graphics module 132 includes various known software components for rendering and displaying graphics on touch screen 112 or other display, including components for changing the intensity of graphics that are displayed. As used herein, the term “graphics” includes any object that can be displayed to a user, including without limitation text, web pages, icons (such as user-interface objects including soft keys), digital images, videos, animations and the like.

[0113] In some embodiments, graphics module 132 stores data representing graphics to be used. Each graphic may be assigned a corresponding code. Graphics module 132 receives, from applications etc., one or more codes specifying graphics to be displayed along with, if necessary, coordinate data and other graphic property data, and then generates screen image data to output to display controller 156.

[0114] Text input module 134, which may be a component of graphics module 132, provides soft keyboards for entering text in various applications (e.g., contacts 137, e-mail 140, IM 141, browser 147, and any other application that needs text input).

[0115] GPS module 135 determines the location of the device and provides this information for use in various applications (e.g., to telephone 138 for use in location-based dialing, to camera 143 as picture/video metadata, and to applications that provide location-based services such as weather widgets, local yellow page widgets, and map/navigation widgets).

[0116] Applications 136 may include the following modules (or sets of instructions), or a subset or superset thereof:

[0117] contacts module 137 (sometimes called an address book or contact list);

[0118] telephone module 138;

[0119] video conferencing module 139;

[0120] e-mail client module 140;

[0121] instant messaging (IM) module 141;

[0122] workout support module 142;

[0123] camera module 143 for still and/or video images;

[0124] image management module 144;

[0125] browser module 147;

[0126] calendar module 148;

[0127] widget modules 149, which may include one or more of: weather widget 149-1, stocks widget 149-2, calculator widget 149-3, alarm clock widget 149-4, dictionary widget 149-5, and other widgets obtained by the user, as well as user-created widgets 149-6;

[0128] widget creator module 150 for making user-created widgets 149-6;

[0129] search module 151;

[0130] video and music player module 152, which may be made up of a video module and a music module;

[0131] notes module 153;

[0132] map module 154; and/or

[0133] online video module 155.

[0134] Examples of other applications 136 that may be stored in memory 102 include other word processing applications, other image editing applications, drawing applications, presentation applications, JAVA-enabled applications, encryption, digital rights management, voice recognition, and voice replication.

[0135] In conjunction with touch screen 112, display controller 156, contact module 130, graphics module 132, and text input module 134, contacts module 137 may be used to manage an address book or contact list (e.g., stored in application internal state 192 of contacts module 137 in memory

102), including: adding name(s) to the address book; deleting name(s) from the address book; associating telephone number(s), e-mail address(es), physical address(es) or other information with a name; associating an image with a name; categorizing and sorting names; providing telephone numbers or e-mail addresses to initiate and/or facilitate communications by telephone 138, video conference 139, e-mail 140, or IM 141; and so forth.

[0136] In conjunction with RF circuitry 108, audio circuitry 110, speaker 111, microphone 113, touch screen 112, display controller 156, contact module 130, graphics module 132, and text input module 134, telephone module 138 may be used to enter a sequence of characters corresponding to a telephone number, access one or more telephone numbers in address book 137, modify a telephone number that has been entered, dial a respective telephone number, conduct a conversation and disconnect or hang up when the conversation is completed. As noted above, the wireless communication may use any of a variety of communications standards, protocols and technologies.

[0137] In conjunction with RF circuitry 108, audio circuitry 110, speaker 111, microphone 113, touch screen 112, display controller 156, and communication module 128, screen power management module 158 controls portions of a screen active for display use as described herein, by controlling or causing the graphics module 132 to display first information in an available display area comprising a first portion of a display screen in a configuration having a plurality of portions, responsive to a user indication in the first portion, add the second portion to the available display area by transitioning the second portion to the powered-on state to perform display functions and receive user input, and display second information in the second portion, as described herein

[0138] In conjunction with RF circuitry 108, audio circuitry 110, speaker 111, microphone 113, touch screen 112, display controller 156, optical sensor 164, screen power management module 158, contact module 130, graphics module 132, text input module 134, contact list 137, and telephone module 138, videoconferencing module 139 includes executable instructions to initiate, conduct, and terminate a video conference between a user and one or more other participants in accordance with user instructions.

[0139] In conjunction with RF circuitry 108, touch screen 112, display controller 156, contact module 130, graphics module 132, and text input module 134, e-mail client module 140 includes executable instructions to create, send, receive, and manage e-mail in response to user instructions. In conjunction with image management module 144, e-mail client module 140 makes it very easy to create and send e-mails with still or video images taken with camera module 143.

[0140] In conjunction with RF circuitry 108, touch screen 112, display controller 156, contact module 130, graphics module 132, and text input module 134, the instant messaging module 141 includes executable instructions to enter a sequence of characters corresponding to an instant message, to modify previously entered characters, to transmit a respective instant message (for example, using a Short Message Service (SMS) or Multimedia Message Service (MMS) protocol for telephony-based instant messages or using XMPP, SIMPLE, or IMPS for Internet-based instant messages), to receive instant messages and to view received instant messages. In some embodiments, transmitted and/or received instant messages may include graphics, photos, audio files, video files and/or other attachments as are supported in a



MMS and/or an Enhanced Messaging Service (EMS). As used herein, “instant messaging” refers to both telephony-based messages (e.g., messages sent using SMS or MMS) and Internet-based messages (e.g., messages sent using XMPP, SIMPLE, or IMPS).

[0141] In conjunction with RF circuitry 108, touch screen 112, display controller 156, contact module 130, graphics module 132, text input module 134, GPS module 135, map module 154, and music player module 146, workout support module 142 includes executable instructions to create workouts (e.g., with time, distance, and/or calorie burning goals); communicate with workout sensors (sports devices); receive workout sensor data; calibrate sensors used to monitor a workout; select and play music for a workout; and display, store and transmit workout data.

[0142] In conjunction with touch screen 112, display controller 156, optical sensor(s) 164, optical sensor controller 159, contact module 130, graphics module 132, and image management module 144, camera module 143 includes executable instructions to capture still images or video (including a video stream) and store them into memory 102, modify characteristics of a still image or video, or delete a still image or video from memory 102.

[0143] In conjunction with touch screen 112, display controller 156, contact module 130, graphics module 132, text input module 134, and camera module 143, image management module 144 includes executable instructions to arrange, modify (e.g., edit), or otherwise manipulate, label, delete, present (e.g., in a digital slide show or album), and store still and/or video images.

[0144] In conjunction with RF circuitry 108, touch screen 112, display system controller 156, contact module 130, graphics module 132, and text input module 134, browser module 147 includes executable instructions to browse the Internet in accordance with user instructions, including searching, linking to, receiving, and displaying web pages or portions thereof, as well as attachments and other files linked to web pages.

[0145] In conjunction with RF circuitry 108, touch screen 112, display system controller 156, contact module 130, graphics module 132, text input module 134, e-mail client module 140, and browser module 147, calendar module 148 includes executable instructions to create, display, modify, and store calendars and data associated with calendars (e.g., calendar entries, to do lists, etc.) in accordance with user instructions.

[0146] In conjunction with RF circuitry 108, touch screen 112, display system controller 156, contact module 130, graphics module 132, text input module 134, and browser module 147, widget modules 149 are mini-applications that may be downloaded and used by a user (e.g., weather widget 149-1, stocks widget 149-2, calculator widget 149-3, alarm clock widget 149-4, and dictionary widget 149-5) or created by the user (e.g., user-created widget 149-6). In some embodiments, a widget includes an HTML (Hypertext Markup Language) file, a CSS (Cascading Style Sheets) file, and a JavaScript file. In some embodiments, a widget includes an XML (Extensible Markup Language) file and a JavaScript file (e.g., Yahoo! Widgets).

[0147] In conjunction with RF circuitry 108, touch screen 112, display system controller 156, contact module 130, graphics module 132, text input module 134, and browser

module 147, the widget creator module 150 may be used by a user to create widgets (e.g., turning a user-specified portion of a web page into a widget).

[0148] In conjunction with touch screen 112, display system controller 156, contact module 130, graphics module 132, and text input module 134, search module 151 includes executable instructions to search for text, music, sound, image, video, and/or other files in memory 102 that match one or more search criteria (e.g., one or more user-specified search terms) in accordance with user instructions.

[0149] In conjunction with touch screen 112, display system controller 156, contact module 130, graphics module 132, audio circuitry 110, speaker 111, RF circuitry 108, and browser module 147, video and music player module 152 includes executable instructions that allow the user to download and play back recorded music and other sound files stored in one or more file formats, such as MP3 or AAC files, and executable instructions to display, present or otherwise play back videos (e.g., on touch screen 112 or on an external, connected display via external port 124). In some embodiments, device 100 may include the functionality of an MP3 player, such as an iPod (trademark of Apple Inc.).

[0150] In conjunction with touch screen 112, display controller 156, contact module 130, graphics module 132, and text input module 134, notes module 153 includes executable instructions to create and manage notes, to do lists, and the like in accordance with user instructions.

[0151] In conjunction with RF circuitry 108, touch screen 112, display system controller 156, contact module 130, graphics module 132, text input module 134, GPS module 135, and browser module 147, map module 154 may be used to receive, display, modify, and store maps and data associated with maps (e.g., driving directions; data on stores and other points of interest at or near a particular location; and other location-based data) in accordance with user instructions.

[0152] In conjunction with touch screen 112, display system controller 156, contact module 130, graphics module 132, audio circuitry 110, speaker 111, RF circuitry 108, text input module 134, e-mail client module 140, and browser module 147, online video module 155 includes instructions that allow the user to access, browse, receive (e.g., by streaming and/or download), play back (e.g., on the touch screen or on an external, connected display via external port 124), send an e-mail with a link to a particular online video, and otherwise manage online videos in one or more file formats, such as H.264. In some embodiments, instant messaging module 141, rather than e-mail client module 140, is used to send a link to a particular online video.

[0153] Each of the above identified modules and applications correspond to a set of executable instructions for performing one or more functions described above and the methods described in this application (e.g., the computer-implemented methods and other information processing methods described herein). These modules (i.e., sets of instructions) need not be implemented as separate software programs, procedures or modules, and thus various subsets of these modules may be combined or otherwise re-arranged in various embodiments. In some embodiments, memory 102 may store a subset of the modules and data structures identified above. Furthermore, memory 102 may store additional modules and data structures not described above.

[0154] In some embodiments, device 100 is a device where operation of a predefined set of functions on the device is

performed exclusively through a touch screen and/or a touchpad. By using a touch screen and/or a touchpad as the primary input control device for operation of device 100, the number of physical input control devices (such as push buttons, dials, and the like) on device 100 may be reduced.

**[0155]** The predefined set of functions that may be performed exclusively through a touch screen and/or a touchpad include navigation between user interfaces. In some embodiments, the touchpad, when touched by the user, navigates device 100 to a main, home, or root menu from any user interface that may be displayed on device 100. In such embodiments, the touchpad may be referred to as a “menu button.” In some other embodiments, the menu button may be a physical push button or other physical input control device instead of a touchpad.

**[0156]** While a portable or mobile computing device is shown as one embodiment of a multifunction device, one of skill in the art will readily realize in light of having read the current disclosure that a desktop computer or other computing device may also perform many of the functions described herein without departing from the scope and intent of the present disclosure. Likewise, while touch screen devices are shown as one embodiment of a multifunction device, one of skill in the art will readily realize in light of having read the current disclosure that a desktop computer or other computing device without a touch screen may also perform many of the functions described herein without departing from the scope and intent of the present disclosure.

**[0157]** FIG. 2 illustrates a portable multifunction device 100 in accordance with some embodiments. The touch screen may display one or more graphics within user interface (UI) 200. In this embodiment, as well as others described below, a user may select one or more of the graphics by making a gesture on the graphics, for example, with one or more fingers 202 (not drawn to scale in the figure) or one or more styluses 203 (not drawn to scale in the figure).

**[0158]** Device 100 may also include one or more physical buttons, such as “home” or menu button 204. As described previously, menu button 204 may be used to navigate to any application 136 in a set of applications that may be executed on device 100. Alternatively, in some embodiments, the menu button is implemented as a soft key in a GUI displayed on touch screen 112.

**[0159]** In one embodiment, device 100 includes touch screen 112, menu button 204, push button 206 for powering the device on/off and locking the device, volume adjustment button(s) 208, Subscriber Identity Module (SIM) card slot 210, head set jack 212, and docking/charging external port 124. Push button 206 may be used to turn the power on/off on the device by depressing the button and holding the button in the depressed state for a predefined time interval; to lock the device by depressing the button and releasing the button before the predefined time interval has elapsed; and/or to unlock the device or initiate an unlock process.

**[0160]** In an alternative embodiment, device 100 also may accept verbal input for activation or deactivation of some functions through microphone 113.

#### User Interface Examples

**[0161]** FIG. 3 illustrates a portable multifunction displaying first information of the active display within the available display area comprising a first portion of a display screen device in accordance with some embodiments. Multifunction device 300 includes an active display 305. A first portion 315

is an available display area 310 and a second portion 320 is in a powered-off condition. As shown in FIG. 3, multifunction device 300 is displaying first information in the available display area 310 comprising the first portion 315 and a second portion 320 of the display screen in a configuration having a plurality of portions, e.g., first portion 315 and second portion 320. The first portion 315 of the display screen 305 is configured in a powered-on state to perform display functions and receive user input. The second portion 320 is configured in a powered-off state. A display main control bar 350 for providing user input is shown.

**[0162]** FIG. 4 depicts a portable multifunction responsive to a user indication in the first portion, adding the second portion to the available display area by transitioning the second portion to the powered-on state to perform display functions and receive user input, and displaying second information in the second portion in accordance with some embodiments. Multifunction device 400 includes a display 405. An available display area 410 includes a first portion 415 and a second portion 420. Note that a third portion 425 remains in a powered-off condition.

**[0163]** To achieve a transition from the state represented in FIG. 3 to the state represented in FIG. 4, multifunction device 400, responsive to a user indication, for instance movement of control bar 350, in the first portion 315, adds the second portion 320 to the available display area 310 by transitioning the second portion 320 to the powered-on state to perform display functions and receive user input, and displays second information in the second portion 320 as illustrated in FIG. 4. User input can be provided by various types of user input (e.g., input suitable for touch-sensitive displays, such as tapping below the display control bar or by a dragging gesture while touching the location of display screen control bar 450), either to provide user input to expand the available display area 410 by transitioning the third portion 425 to the powered-on state to perform display functions and receive user input or to provide user input to contract the available display area 410 by transitioning the second portion 420 to the powered-off state.

**[0164]** FIG. 5 illustrates a portable multifunction displaying first information in an available display area comprising a first portion of a display screen device in accordance with some embodiments. Multifunction device 500 includes a display 505. A first portion 515 is an available display area 510 and a second portion 520 is in a powered-off condition. As shown in FIG. 5, multifunction device 500 is displaying first information in the available display area 510 comprising the first portion 515 of the display screen in a configuration having a plurality of portions, e.g., first portion 515 and second portion 520. The first portion 515 of the display screen 505 is configured in a powered-on state to perform display functions and receive user input. The second portion 520 is configured in a powered-off state. A display control bar 550 for providing user input is shown.

**[0165]** To achieve a transition from the state represented in FIG. 4 to the state represented in FIG. 5, multifunction device 500, responsive to a user indication, for instance movement of control bar 550, in the second portion 520, transitions the second portion 520 to the powered-off state to perform display functions. User input can be provided (e.g., input suitable for touch-sensitive displays, such as by tapping below the display control bar or by a dragging gesture while touching the location of display control bar 550) to provide user input to expand the available display area 510 by transitioning

the second portion 520 to the powered-on state to perform display functions and receive user input.

[0166] FIG. 6 depicts a portable multifunction responsive to a user indication in the in the first portion, adding the second portion to the available display area by transitioning the second portion to the powered-on state to perform display functions and receive user input, and displaying second information in the second portion in accordance with some embodiments. Multifunction device 600 includes a display 605. An available display area 610 includes a first portion 615 and a second portion 620.

[0167] To achieve a transition from the state represented in FIG. 5 to the state represented in FIG. 6, multifunction device 600, responsive to a user indication, for instance movement of control bar 650, in the in the first portion 615, adds the second portion 620 to the available display area 610 by transitioning the second portion 415 to the powered-on state to perform display functions and receive user input, and displays second information in the second portion 620. User input can be provided, e.g., by tapping below the display control bar or by a dragging gesture while touching the location of display control bar 650, to provide user input to contract the available display area 610 by transitioning the second portion 620 to the powered-off state.

[0168] FIG. 7 illustrates a portable multifunction displaying first information in an available display area comprising a first portion of a display screen device in accordance with some embodiments. Multifunction device 700 includes a display 705. A first portion 715 is an available display area 710 and a second portion 720 is in a powered-off condition. As shown in FIG. 7, multifunction device 700 is displaying first information in the available display area 710 comprising the first portion 715 of the display screen in a configuration having a plurality of portions, e.g., first portion 715 and second portion 720.

[0169] The first portion 715 of the display screen 705 is configured in a powered-on state to perform display functions and receive user input. The second portion 720 is configured in a powered-off state. A display control bar 750 for providing user input is shown. Selected interface elements 725 are shown, as well as a scaled element 730. Selected interface elements 725 are, in some embodiments, a subset of elements of included in a graphical content data structure comprising content for display in the available display area 710, and embodiments select the selected interface elements 725 of the graphical content data structure for display in the available display area 710 based at least in part on whether the second portion 720 is in a powered-on state.

[0170] In some embodiments, a size of scaled element 730 is determined by scaling elements of the graphical content data structure for display in the available display area based at least in part on a dimension of the available display area. In some embodiments, a size of scaled element 730 is determined by scaling elements of the graphical content data structure for display in the available display area based at least in part on whether the second portion is in a powered-on state.

[0171] In some embodiments, positions of selected elements 825 are determined by adjusting a position relative to a background element of a foreground content element of the graphical content data structure for display in the available display area based at least in part on whether the second portion is in a powered-on state. In some embodiments, selected interface elements 725 of the graphical content data

structure may be selected for display in the available display area 710 based at least in part on a dimension of the available display area.

[0172] FIG. 8 depicts a portable multifunction responsive to a user indication in the in the first portion, adding the second portion to the available display area by transitioning the second portion to the powered-on state to perform display functions and receive user input, and displaying second information in the second portion in accordance with some embodiments. Multifunction device 800 includes a display 805. A first portion 815 and a second portion 820 are in a available display area 810, and a third portion 830 is in a powered-off condition. As shown in FIG. 8, multifunction device 800 is displaying first information in the available display area 810 comprising the first portion 815 of the display screen in a configuration having a plurality of portions, e.g., first portion 815 and second portion 820.

[0173] The first portion 815 and the second portion 820 of the display screen 805 are configured in a powered-on state to perform display functions and receive user input. The third portion 830 is configured in a powered-off state. A display control bar 850 for providing user input is shown. Selected interface elements 825 are shown, as well as a scaled element 830. Selected interface elements 825 are, in some embodiments, a subset of elements of included in a graphical content data structure comprising content for display in the available display area 810, and embodiments select the selected interface elements 825 of the graphical content data structure for display in the available display area 810 based at least in part on whether the second portion 820 is in a powered-on state.

[0174] In some embodiments, a size of scaled element 830 is determined by scaling elements of the graphical content data structure for display in the available display area based at least in part on a dimension of the available display area. In some embodiments, a size of scaled element 830 is determined by scaling elements of the graphical content data structure for display in the available display area based at least in part on whether the second portion is in a powered-on state.

[0175] In some embodiments, positions of selected elements 825 are determined by adjusting a position relative to a background element of a foreground content element of the graphical content data structure for display in the available display area based at least in part on whether the second portion is in a powered-on state. In some embodiments, selected interface elements 825 of the graphical content data structure may be selected for display in the available display area 810 based at least in part on a dimension of the available display area.

[0176] FIG. 9 illustrates a portable multifunction displaying first information in an available display area comprising a first portion of a display screen device in accordance with some embodiments. Multifunction device 900 includes a display 905. A first portion 915 is an available display area 910 and a second portion 920 is in a powered-off condition. As shown in FIG. 9, multifunction device 900 is displaying first information in the available display area 910 comprising the first portion 915 of the display screen in a configuration having a plurality of portions, e.g., first portion 915 and second portion 920. The first portion 915 of the display screen 905 is configured in a powered-on state to perform display functions and receive user input. The second portion 920 is configured in a powered-off state. A display control bar 950 for providing user input is shown.

[0177] FIG. 10 depicts a portable multifunction responsive to a user indication in the in the first portion, adding the second portion to the available display area by transitioning the second portion to the powered-on state to perform display functions and receive user input, and displaying second information in the second portion in accordance with some embodiments. Multifunction device 1000 includes a display 1005. A first portion 1015 is an available display area 1010 and a second portion 1020 is in a powered-off condition. As shown in FIG. 10, multifunction device 1000 is displaying first information in the available display area 1010 comprising the first portion 1015 of the display screen in a configuration having a plurality of portions, e.g., first portion 1015 and second portion 1020. The first portion 1015 of the display screen 1005 is configured in a powered-on state to perform display functions and receive user input. The second portion 1020 is configured in a powered-off state. A display control bar 1050 for providing user input is shown.

[0178] FIG. 11 illustrates a portable multifunction displaying first information in an available display area comprising a first portion of a display screen device in accordance with some embodiments. FIG. 11 depicts a portable multifunction responsive to a user indication in the in the first portion, adding the second portion to the available display area by transitioning the second portion to the powered-on state to perform display functions and receive user input, and displaying second information in the second portion in accordance with some embodiments. Multifunction device 1100 includes a display 1105. An available display area 1110 includes a first portion 1115 and a second portion 1120.

[0179] FIG. 12 depicts a portable multifunction displaying first information in an available display area comprising a first portion of a display screen device in accordance with some embodiments. Multifunction device 1200 includes a display 1205. A first portion 1215 is an available display area 1210 and a second portion 1220 is in a powered-off condition. As shown in FIG. 12, multifunction device 1200 is displaying first information in the available display area 1210 comprising the first portion 1215 of the display screen in a configuration having a plurality of portions, e.g., first portion 1215 and second portion 1220. The first portion 1215 of the display screen 1205 is configured in a powered-on state to perform display functions and receive user input. The second portion 1220 is configured in a powered-off state and may be used as a grip.

[0180] FIG. 13 illustrates a portable multifunction responsive to a user indication in the in the first portion, adding the second portion to the available display area by transitioning the second portion to the powered-on state to perform display functions and receive user input, and displaying second information in the second portion in accordance with some embodiments. FIG. 13 depicts a portable multifunction responsive to a user indication in the in the first portion, adding the second portion to the available display area by transitioning the second portion to the powered-on state to perform display functions and receive user input, and displaying second information in the second portion in accordance with some embodiments. Multifunction device 1300 includes a display 1305. An available display area 1310 includes a first portion 1315 and a second portion 1320.

[0181] FIG. 14 depicts a portable multifunction displaying a display screen device in accordance with some embodiments. FIG. 14 depicts a portable multifunction responsive to a user indication in the in the first portion, adding the second

portion to the available display area by transitioning the second portion to the powered-on state to perform display functions and receive user input, and displaying second information in the second portion in accordance with some embodiments. Multifunction device 1400 includes a display 1405. An available display area 1410 includes a first portion 1415 and a second portion 1420.

[0182] FIG. 15 illustrates a portable multifunction displaying a display screen device in accordance with some embodiments. Multifunction device 1500 includes a display 1505. A first portion 1515 is an available display area 1510 and a second portion 1520 is in a powered-off condition. As shown in FIG. 15, multifunction device 1500 is displaying first information in the available display area 1510 comprising the first portion 1515 of the display screen in a configuration having a plurality of portions, e.g., first portion 1515 and second portion 1520. The first portion 1515 of the display screen 1505 is configured in a powered-on state to perform display functions and receive user input. The second portion 1520 is configured in a powered-off state and may be used as a grip.

[0183] FIG. 16 depicts a portable multifunction displaying first information in an available display area comprising a first portion of a display screen device in accordance with some embodiments. FIG. 16 depicts a portable multifunction responsive to a user indication in the in the first portion, adding the second portion to the available display area by transitioning the second portion to the powered-on state to perform display functions and receive user input, and displaying second information in the second portion in accordance with some embodiments. Multifunction device 1600 includes a display 1605. An available display area 1610 includes a first portion 1615 and a second portion 1620.

[0184] FIG. 17 illustrates a portable multifunction responsive to a user indication in the in the first portion, adding the second portion to the available display area by transitioning the second portion to the powered-on state to perform display functions and receive user input, and displaying second information in the second portion in accordance with some embodiments. Multifunction device 1700 includes a display 1705. A first portion 1715 is an available display area 1710 and a second portion 1720 is in a powered-off condition. As shown in FIG. 17, multifunction device 1700 is displaying first information in the available display area 1710 comprising the first portion 1715 of the display screen in a configuration having a plurality of portions, e.g., first portion 1715 and second portion 1720. The first portion 1715 of the display screen 1705 is configured in a powered-on state to perform display functions and receive user input. The second portion 1720 is configured in a powered-off state and may be used as a grip.

[0185] FIG. 18 depicts a portable multifunction responsive to a user indication in the first portion, adding the second portion to the available display area by transitioning the second portion to the powered-on state to perform display functions and receive user input, and displaying second information in the second portion in accordance with some embodiments. Multifunction device 1800 includes a display 1805. A first portion 1815 is an available display area 1810 and a second portion 1820 is in a powered-off condition. As shown in FIG. 18, multifunction device 1800 is displaying first information in the available display area 1810 comprising the first portion 1815 of the display screen in a configuration having a plurality of portions, e.g., first portion 1815 and second portion 1820. The first portion 1815 of the display

screen **1805** is configured in a powered-on state to perform display functions and receive user input. The second portion **1820** is configured in a powered-off state and may be used as a grip.

[0186] FIG. **19** illustrates a portable multifunction with a display screen device in accordance with some embodiments. FIG. **19** depicts a portable multifunction responsive to a user indication in the in the first portion, adding the second portion to the available display area by transitioning the second portion to the powered-on state to perform display functions and receive user input, and displaying second information in the second portion in accordance with some embodiments. Multifunction device **1900** includes a display **1905**. An available display area **1910** includes a first portion **1915** and a second portion **1920**.

[0187] In FIG. **19**, multifunction device **1900** has been rotated 90 degrees and the displayed features of the application being displayed, along with the time and signal strength icon have rotated 90 degree in the other direction so as to appear upright. In some of the previous illustrations, the icons associated with applications are illustrated as retaining their orientation with the device as the device is rotated. In some embodiments, the icons may re-orient so as to appear upright when the device has been tilted or turned. In some embodiments, the application being displayed may or may not reorient so as to appear upright. In embodiments, such functionality may be configurable, for example via program instructions **4722**, state information **2570**, **2590** or via image management module **144**, graphics module **132** or the like. In embodiments, the time and signal strength tool bar may be configured to be oriented with the device or with the icons or with the application, based on how such elements of the display orient themselves in response to orientation of the device.

[0188] In FIG. **19A**, multifunction device **1900** has been rotated 90 degrees and the displayed features of the application being displayed have rotated 90 degree in the other direction so as to appear upright. In FIG. **19A**, the indicator display **1935** (e.g., illustrating time and signal strength indicators) has not rotated 90 degree in the other direction so as to appear upright. In embodiments, the indicator display may rotate with the display. In some embodiments, the indicator display may rotate with the displayed features of the application, for example. In embodiments, the indicator display may remain displayed while in a display portion that is otherwise powered-off or may be reconfigured by one or more components of the device to be displayed entirely within the power-on portion, without any reduced functionality, for example. For example, the indicator display crosses from a first portion (e.g., first portion **1915**) to a second portion (e.g., second portion **1920**) in FIG. **19**. If the device **1900** changed mode or state such that the second portion of the display was placed into a powered-off mode, the indicator display may either remain displayed as it is, or may be reconfigured to only appear in the first portion, albeit continuing to display the same or similar indicators such that the portion of the indicator display **1935** illustrated in the second portion **1920** would appear in the first portion **1915**.

[0189] In some of the illustrations, the icons associated with applications are illustrated as retaining their orientation with the device as the device is rotated. In some embodiments, the icons may re-orient so as to appear upright when the device has been tilted or turned. In some embodiments, the application being displayed may or may not reorient so as to

appear upright. In embodiments, such functionality may be configurable, for example via program instructions **4722**, state information **2570**, **2590** or via image management module **144**, graphics module **132** or the like. In embodiments, the time and signal strength tool bar may be configured to be oriented with the device or with the icons or with the application, based on how such elements of the display orient themselves in response to orientation of the device.

[0190] FIG. **20** depicts a portable multifunction with a display screen device in accordance with some embodiments. FIG. **20** depicts a portable multifunction responsive to a user indication in the in the first portion, adding the second portion to the available display area by transitioning the second portion to the powered-on state to perform display functions and receive user input, and displaying second information in the second portion in accordance with some embodiments. Multifunction device **2000** includes a display **2005**. An available display area **2010** includes a first portion **2015** and a second portion **2020**.

[0191] FIG. **21** illustrates a portable multifunction with a display screen device in accordance with some embodiments. FIG. **21** depicts a portable multifunction responsive to a user indication in the in the first portion, adding the second portion to the available display area by transitioning the second portion to the powered-on state to perform display functions and receive user input, and displaying second information in the second portion in accordance with some embodiments. Multifunction device **2100** includes a display **2105**. An available display area **2110** includes a first portion **2115** and a second portion **2120**.

[0192] FIG. **22** depicts a portable multifunction with a display screen device in accordance with some embodiments. FIG. **22** depicts a portable multifunction responsive to a user indication in the in the first portion, adding the second portion to the available display area by transitioning the second portion to the powered-on state to perform display functions and receive user input, and displaying second information in the second portion in accordance with some embodiments. Multifunction device **2200** includes a display **2205**. An available display area **2210** includes a first portion **2215** and a second portion **2220**.

[0193] FIG. **23** illustrates a portable multifunction with a display screen device in accordance with some embodiments. FIG. **23** depicts a portable multifunction responsive to a user indication in the in the first portion, adding the second portion to the available display area by transitioning the second portion to the powered-on state to perform display functions and receive user input, and displaying second information in the second portion in accordance with some embodiments. Multifunction device **2300** includes a display **2305**. An available display area **2310** includes a first portion **2315** and a second portion **2320**.

[0194] FIG. **24** depicts a portable multifunction with a display screen device in accordance with some embodiments. Multifunction device **2400** includes a display **2405**. A first portion **2415** is an available display area **2410** and a second portion **2420** is in a powered-off condition. As shown in FIG. **24**, multifunction device **2400** is displaying first information in the available display area **2410** comprising the first portion **2415** of the display screen in a configuration having a plurality of portions, e.g., first portion **2415** and second portion **2420**. The first portion **2415** of the display screen **2405** is configured in a powered-on state to perform display functions

and receive user input. The second portion **2420** is configured in a powered-off state and may be used as a grip.

#### Screen Power Management Module

**[0195]** FIG. **25** illustrates a display power management module for managing display power consumption, according to some embodiments. Screen power management module **2500** includes a configuration module **2510**, a utilization determination module **2520**, an element management module **2530**, and a scale management module **2540**. Screen power management module **2500** receives as input system events **2550** and user stimulus **2560**, stores existing state information **2570** and screen portion transition conditions **2580**, and generates as output new state information **2590**.

**[0196]** In some embodiments, configuration module **2510** allocates display screen space to a first portion of the display screen, which is configured in a powered-on state to perform display functions and receive user input, and a second portion of the display screen, which is configured in a powered-off state. In such a state, a graphics module, such as graphics module **132** of FIG. **1**, performs displaying first information in an available display area comprising a first portion of a display screen in a configuration having a plurality of portions, as described above. Responsive to a user indication in the first portion, which is received by screen power management module as a user stimulus **2560**, utilization determination module **2520** may perform adding the second portion to the available display area by, in conjunction with configuration module **2510**, transitioning the second portion to the powered-on state to perform display functions and receive user input. Configuration module **2510** may reverse the configuration of the display, and a portion of the display screen may be removed from the powered-on state to the powered off state in response to user input. Likewise, the actions described herein as being performed in response to user input may, in some embodiments, be performed in response to system events **2550** such as the passage of an amount of time or a signal from an application or system module, or other system events **2550**, such as a power-down or sleep signal.

**[0197]** In embodiments, one or more of the modules of the screen power management module **2500** may configure (e.g., coordinately configure) the color of the display. For example, user-defined display color settings may be stored as existing state information **2570** and/or element management module **2530** or configuration module **2510** may instruct configuration of the display in particular colors. In some embodiments, the color(s) used for the display may be configured based on a corresponding state or mode. For example, a device or display that is in a power-saving mode or in a proportional configuration mode may be configured to display in grayscale or in black and white. In some embodiments, the graphics module, display controller or the display system **112** may be configured to perform similar functionality.

**[0198]** In some embodiments, utilization determination module **2520** performs adding the second portion to the available display area by, in conjunction with configuration module **2510**, transitioning the second portion to the powered-on state to perform display functions and receive user input in response to system events **2560**, such as stimulus provided by an application or a module of the multifunction device.

**[0199]** In either case, a graphics module, such as graphics module **132** of FIG. **1**, may then perform displaying second information in the second portion. States of the first and

second portion are stored in existing state information **2570**. New state information **2590** includes instructions to a graphics module, such as graphics module **132** of FIG. **1**, for implementing transitioning the second portion to the powered-on state to perform display functions and receive user input.

**[0200]** In some embodiments, scale management module **2540** performs generating the second information by mathematically upscaling the first information. The second information includes a portion of the first information upscaled for display in both the second portion and the first portion. In some such embodiments, a graphics module, such as graphics module **132** of FIG. **1**, performs displaying third information in the first portion. The third information comprises a portion of the first information upscaled for display in both the second portion and the first portion.

**[0201]** In some embodiments, system events **2550** include graphical content data structures. Screen power management module **2500** performs receiving a graphical content data structure including content for display in the available display area. Element management module **2530** performs selecting elements of the graphical content data structure for display in the available display area based at least in part on whether the second portion is in a powered-on state.

**[0202]** In some embodiments, system events **2550** include graphical content data structures. Screen power management module **2500** performs receiving a graphical content data structure including content for display in the available display area. Scale management module **2540** performs scaling elements of the graphical content data structure for display in the available display area based at least in part on a dimension of the available display area.

**[0203]** In some embodiments, system events **2550** include graphical content data structures. Screen power management module **2500** performs receiving a graphical content data structure including content for display in the available display area. Scale management module **2540** performs scaling elements of the graphical content data structure for display in the available display area based at least in part on whether the second portion is in a powered-on state.

**[0204]** In some embodiments, system events **2550** include graphical content data structures. Screen power management module **2500** performs receiving a graphical content data structure including content for display in the available display area. Element management module **2530** performs adjusting a position relative to a background element of a foreground content element of the graphical content data structure for display in the available display area based at least in part on whether the second portion is in a powered-on state.

**[0205]** In some embodiments, system events **2550** include graphical content data structures. Screen power management module **2500** performs receiving a graphical content data structure including content for display in the available display area. Element management module **2530** performs selecting elements of the graphical content data structure for display in the available display area based at least in part on a dimension of the available display area.

**[0206]** In embodiments, the functionality associated with the screen power module may be incorporated into the operating system of a device. In other embodiments, the functionality associated with the screen power module may be incorporated into an application that interacts with the operating system. In some embodiments, the described functionality may be divided among an application and the operating sys-

tem. In some embodiments, the power management module **2500** may send instructions to direct the display controller **156**, as described herein.

#### Example Operations

**[0207]** FIG. **26** is a flow diagram illustrating one embodiment of a method for managing display power consumption, according to some embodiments. First information is displayed in an available display area comprising a first portion of a display screen in a configuration having a plurality of portions, including the first portion of the display screen, which is configured in a powered-on state to perform display functions and receive user input, and a second portion of the display screen, which is configured in a powered-off state (block **2600**). Responsive to a user indication in the in the first portion, the second portion is added to the available display area by transitioning the second portion to the powered-on state to perform display functions and receive user input (block **2610**). Second information is displayed in the second portion (block **2620**).

**[0208]** The process is reversible, and a portion of the display screen may be removed from the powered-on state to the powered off state in response to user input. Likewise, the actions described herein as being performed in response to user input may, in some embodiments, be performed in response to system events such as the passage of an amount of time or a signal from an application or system module, or other system events, such as a power-down or sleep signal.

**[0209]** FIG. **27** is a flow diagram illustrating one embodiment of a method for managing display power consumption, according to some embodiments. First information is displayed in an available display area comprising a first portion of a display screen in a configuration having a plurality of portions, including the first portion of the display screen, which is configured in a powered-on state to perform display functions and receive user input, and a second portion of the display screen, which is configured in a powered-off state (block **2700**). Responsive to a user indication in the in the first portion, the second portion is added to the available display area by transitioning the second portion to the powered-on state to perform display functions and receive user input (block **2710**). Second information is generated by mathematically upscaling the first information. The second information includes a portion of the first information upscaled for display in both the second portion and the first portion (block **2720**). The second information is displayed in the second portion (block **2730**). Third information is displayed in the first portion. The third information comprises a portion of the first information upscaled for display in both the second portion and the first portion (block **2740**).

**[0210]** FIG. **28** is a flow diagram illustrating one embodiment of a method for managing display power consumption, according to some embodiments. A graphical content data structure including content for display in the available display area is received (block **2800**). Elements of the graphical content data structure are selected for display in the available display area based at least in part on whether the second portion is in a powered-on state (block **2810**). First information is displayed in an available display area comprising a first portion of a display screen in a configuration having a plurality of portions, including the first portion of the display screen, which is configured in a powered-on state to perform display functions and receive user input, and a second portion of the display screen, which is configured in a powered-off

state (block **2820**). Responsive to a user indication in the in the first portion, the second portion is added to the available display area by transitioning the second portion to the powered-on state to perform display functions and receive user input (block **2830**).

**[0211]** FIG. **29** is a flow diagram illustrating one embodiment of a method for managing display power consumption, according to some embodiments. A graphical content data structure comprising content for display in the available display area is received (block **2900**). Elements of the graphical content data structure are scaled for display in the available display area based at least in part on a dimension of the available display area (block **2910**). First information is displayed in an available display area comprising a first portion of a display screen in a configuration having a plurality of portions, including the first portion of the display screen, which is configured in a powered-on state to perform display functions and receive user input, and a second portion of the display screen, which is configured in a powered-off state (block **2920**). Responsive to a user indication in the in the first portion, the second portion is added to the available display area by transitioning the second portion to the powered-on state to perform display functions and receive user input (block **2930**).

**[0212]** FIG. **30** is a flow diagram illustrating one embodiment of a method for managing display power consumption, according to some embodiments. A graphical content data structure comprising content for display in the available display area is received (block **3000**). Elements of the graphical content data structure are scaled for display in the available display area based at least in part on whether the second portion is in a powered-on state (block **3010**). First information is displayed in an available display area comprising a first portion of a display screen in a configuration having a plurality of portions, including the first portion of the display screen, which is configured in a powered-on state to perform display functions and receive user input, and a second portion of the display screen, which is configured in a powered-off state (block **3020**). Responsive to a user indication in the first portion, the second portion is added to the available display area by transitioning the second portion to the powered-on state to perform display functions and receive user input (block **3030**).

**[0213]** FIG. **31** is a flow diagram illustrating one embodiment of a method for managing display power consumption, according to some embodiments. A graphical content data structure comprising content for display in the available display area is received (block **3100**). A position relative to a background element of a foreground content element of the graphical content data structure is adjusted for display in the available display area based at least in part on whether the second portion is in a powered-on state (block **3110**). First information is displayed in an available display area comprising a first portion of a display screen in a configuration having a plurality of portions, including the first portion of the display screen, which is configured in a powered-on state to perform display functions and receive user input, and a second portion of the display screen, which is configured in a powered-off state (block **3120**). Responsive to a user indication in the in the first portion, the second portion is added to the available display area by transitioning the second portion to the powered-on state to perform display functions and receive user input (block **3130**).

[0214] FIG. 32 is a flow diagram illustrating one embodiment of a method for managing display power consumption, according to some embodiments. A graphical content data structure comprising content for display in the available display area is received (block 3200). Elements of the graphical content data structure are selected for display in the available display area based at least in part on a dimension of the available display area (block 3210). First information is displayed in an available display area comprising a first portion of a display screen in a configuration having a plurality of portions, including the first portion of the display screen, which is configured in a powered-on state to perform display functions and receive user input, and a second portion of the display screen, which is configured in a powered-off state (block 3220). Responsive to a user indication in the first portion, the second portion is added to the available display area by transitioning the second portion to the powered-on state to perform display functions and receive user input (block 3230).

[0215] FIG. 33 is a flow diagram illustrating an embodiment of a method for unlocking a display and transitioning the display into either a full configuration mode or a proportional configuration mode. Multifunction devices may set themselves (e.g., based on a timer that detects no use) or may be set via the user interface into an interface lock state, in embodiments. The device interface may provide a reduced set of features and responses to user input while in the interface lock state. For example, a device in the interface lock state may provide a limited number of graphic(s) via the display and respond to a limited number of input commands (e.g., only responding to one or a few types of particular input, such as a particular swipe with respect to a displayed object). In embodiments, the described methods may be performed by various modules, such as the modules of a screen power management module 2500.

[0216] In embodiments, a device may be configured to exhibit multiple display modes. For example, when the device (e.g., the display controller or the screen power management module or the touch-sensitive display system) is in a display mode, at least some portion of the display system may be configured to perform display functionality. In another example, when the display controller of the device is in another mode, such as a sleep mode, at least some portion or all of the display may be configured with limited or no functionality. Other modes, exhibiting other types of limited functionality, alone or in combination are also contemplated.

[0217] At block 3310, a screen or device may be set to a user interface lock state by any predefined manner where the lock state prevents the device from performing a predefined set of actions. For example, either user stimulus 2560 or system events 2550 may cause the device to be set to a user interface lock state and state information indicating the lock state may be stored as existing state information 2570, in some embodiments. At block 3320, an unlock image may be displayed via the screen while the screen/device is in the lock state. In some embodiments, the element management module may determine from state information 2570 that the device or screen is in the lock state and provide an image of an unlock element or object to be displayed to the screen, by graphics module 132, for example. For example, FIG. 35 illustrates a graphic BAR as an unlock image 3550.

[0218] At 3330, contact with the device screen (e.g., a touch sensitive display) may be detected. For example, a touch sensitive display of the device may determine that a user has

touched the screen. At 3340, a determination may be made whether the contact corresponds to an unlock gesture using the unlock image. For example, a particular type of contact may be required to unlock the device from the user interface lock state, such that other types of contact do not unlock the lock state. When the contact does not correspond to an unlock gesture using the lock image, the method may continue to block 3350, wherein the device is maintained in the user-interface lock state.

[0219] When the contact does correspond to an unlock gesture using the unlock image, the method may continue to block 3360 where a determination is made whether the unlock gesture indicates a proportional configuration mode. For example, in some embodiments, more than one type of contact may be recognized. Different types of contact may be associated with different instructions of how to transition from the user interface lock state. In one embodiment, a certain type of swipe using the unlock image may indicate an instruction to transition to a full configuration mode 3370 and a different type of swipe may indicate an instruction to a proportional configuration mode as indicated at block 3380. FIG. 35, for example, illustrates that when a swipe to the left corresponds with unlock image 3550, a transition to a configuration mode is instructed (3525) and that when a swipe to the right corresponds with unlock image 3550, a transition to another configuration mode is instructed. In some embodiments, the configuration modes to transition to may be full or proportional display configuration modes. The device may transition to the indicated mode (e.g., proportional configuration mode or full configuration mode) after receiving the instruction to transition, in embodiments.

[0220] FIG. 34 illustrates a portable multifunction with a display screen in accordance with some embodiments. The illustrated multifunction device 3400 is illustrated comprising display screen 3405. In the illustrated embodiment, the display 3405 is entirely in a powered-off mode. In this particular embodiment, the display 3405 is illustrated in black to indicate that no power is being used to illuminate any portion of the display 3405. Other displays may be other colors when in a powered-off state.

[0221] FIG. 35 illustrates a portion of a portable multifunction with a display screen in accordance with some embodiments. In some embodiments, the illustrated multifunction device 3500 of FIG. 35 may be the same multifunction device as illustrated in FIG. 34, but in a different mode. In other embodiments, the illustrated multifunction device 3500 of FIG. 35 may be a different multifunction device than illustrated in FIG. 34.

[0222] In the illustrated embodiment, the multifunction device 3500 of FIG. 35 is in a powered-off state. In embodiments, a multifunction device may continuously (e.g., while in the powered-off state) display any of one or more graphical indications while in a powered-off state. In the illustrated powered-off state, the multifunction device 3500 continuously (e.g., while in the powered-off state) displays the time (e.g., 10:10 A.M.), date (e.g., Thursday, Jan. 16, 2014) and indications of notices of emails (e.g., Email icon 3510), SMS, texts (e.g., text message icon 3520), messages (e.g., voice message icon 3515), and the like. Also illustrated in the continuous display are icons for battery power supply amount, local wireless connectivity, WiFi connectivity and carrier signal strength. Other graphical indications of other features are contemplated as well. For example, the unlock image 3550 of the BAR may be continuously displayed in the powered-off



state. In some embodiments, some or all such graphical indications cover a limited surface area of the total screen. In some embodiments, such graphical indications consume a limited amount of battery power. In some embodiments, the limited amount of battery power consumed may be in a ratio with the amount of surface area covered. In some embodiments, providing some such information via the continuous display may reduce the wear and tear and chance of mechanical breakdown of use of mechanical (e.g., on-off) switches used to access such information. In other embodiments, the continuous display of some such information may reduce the number of times the device is put into a powered-on state that uses more battery power than the continuous display powered-off mode described herein.

[0223] FIGS. 36-38 illustrate multifunction devices in various configurations and states. The displays of the devices are illustrated with various arrangements of the icons, but without the control bar 450 illustrated in FIG. 4, for example. In embodiments (not illustrated) the illustrated devices and displays of FIGS. 36-38 may include control bar 450, without departing from the scope of this disclosure.

[0224] FIG. 36 illustrates a portable multifunction device 3600 with a display screen 3605 in accordance with some embodiments. The illustrated embodiment includes the entire available display area 3610. In the illustrated embodiment, 100% of the display 3605 is active (e.g., in a powered-on state configured to perform display functions and/or receive user input). In embodiments, active may indicate display functionality or user-input functionality although additional or different functionality may be associated with an active display area as well. In some embodiments, an active display may indicate that the display is limited to a particular functionality such as display functionality only or receive input functionality only.

[0225] FIG. 37 illustrates a portable multifunction device 3700 with a display screen 3705 in accordance with some embodiments. In some, but not all embodiments, FIG. 37 illustrates the same multifunction device as in FIG. 36, but in a different configuration mode. In at least one embodiment, device 3700 illustrates the same device 3600, but in a proportional configuration mode. As illustrated, a first portion 3720 of display 3705 is all black, indicating that the first portion is in a powered-off state while the second portion(s) 3730 (e.g., the icon graphical elements) are illustrated in a powered-on state. FIG. 37 illustrates that the portions of the display that are in a powered-on state do not need to be contiguous. In embodiments (not illustrated) the portions of the display that are in a powered-off state need not be contiguous.

[0226] FIG. 38 illustrates a portable multifunction device 3800 with a display screen 3805 in accordance with some embodiments. Multifunction device 3800 is illustrated in a configuration with all of the icons grouped together in a single area (a first portion 3815) of the display 3805. The second portion 3820 is illustrated in black to indicate that portion is in a powered-off state. In embodiments, the icons in the first portion may be downsized (e.g., with respect to the icons illustrated in FIG. 36) to fit in a smaller area. In another embodiment, the space between icons may be removed to fit the icons into a smaller portion of the screen. The unused portion of the screen may be directed, instructed or configured into a powered-off state in some configurations.

[0227] FIG. 39 is a flow diagram illustrating an embodiment of a method for transitioning a display from a full configuration mode to a proportional configuration mode.

The methods described in FIG. 39 may be performed by modules of the screen power management module 3500, singly or in combination.

[0228] An entire (e.g., the entire available display screen) display screen may function in a full configuration mode where all of the display screen is in a power-on state, as at block 3900. For example, the screen power management module 2500 may direct the configuration of the screen according to data in existing state information module 2570 that may store the particular configuration mode and the state of the display.

[0229] Instructions may be received to transition from the full configuration mode to a proportional configuration mode that configures a portion of the display screen in a powered-on state and another portion of the display screen in a powered-off state as at block 3910. For example, screen transition portion transition conditions module 2580 may listen for particular system events 2550 or indications of user stimulus 2560 that match the transition conditions for the particular configuration mode. In some embodiments, system events may include the battery power level reaching a predetermined level or amount (e.g., 35%) or the user interface receiving an indication of user stimulus indicating a particular mode and sending the instructions for the particular mode to the screen power management module 2500.

[0230] Responsive to receiving the instruction(s) to transition from the full configuration mode to a proportional configuration mode, a portion of the display or screen remains powered-on while the other portion of the display is directed to power-off. For example, the utilization determination module 2520 may be configured to work in concert with the configuration module 2510 to transition the display from full configuration mode to proportional configuration mode. In some embodiments, the modules of the screen power management module 2500 send instructions to the graphics module 132, instructing the graphics module to power a portion of the display and to not power the other portion of the display. In embodiments, the process is reversible to put the device back into the full configuration mode where the entire screen is in the powered-on state.

[0231] FIGS. 40-42 illustrate a battery level feature that may be used to control the transition into and out of the proportional configuration mode, in embodiments. FIG. 40 illustrates a portable multifunction with a display screen in accordance with some embodiments. Although the black and white drawings of this application limit the illustration, it is intended that the icon elements of FIG. 40 are displayed in various colors and that the background behind the icons of the various applications could be of any color as well. This is in contrast to the device illustrated in FIG. 41, where it is intended that the display of the device be configured such that the black portion illustrated is in a powered-off state and the portions of the icons that appear white in the FIG. 41 could be of any color, such as the illustrated white, grayscale or any other color while in the powered-on state as illustrated.

[0232] FIG. 40 illustrates a portable multifunction device 4000 with a display 4005 and a control bar 4050, in accordance with some embodiments. In some embodiments, the display 4005 is in color, while in other embodiments, the display may be in grayscale or black and white. In the illustrated embodiment, the available display area 4010 is at 100% of the display 4005, in accordance with the device being configured in the full configuration mode. In the illustrated embodiment, the control bar 4050 is included on the display

in the full configuration mode. In some embodiments, the control bar 4050 may not be displayed when the display is in the full configuration mode. In other embodiments, the control bar 4050 may be displayed while the display is in the full configuration mode, as a graphic that may be interacted with via the user interface to instruct the device to transition to the proportional configuration mode, for example.

[0233] A battery level auto shift value 4025 is illustrated in FIG. 40. In embodiments, the battery level may be a condition upon which the configuration may be changed from the proportional mode to the full mode or from the full mode to the configuration mode. For example, the device may be configured such that the display transitions from the full configuration mode to the proportional configuration mode when the battery level auto shift value reaches or reaches a point below a certain value (e.g., 35%).

[0234] FIG. 41 illustrates a portable multifunction device 4100 with a display screen 4105 and a battery level auto shift value 4125, in accordance with some embodiments. FIG. 41 illustrates that when the battery level auto shift value 4125 achieves a level less than a predefined level (e.g., 35%) the display may be put into a proportional configuration mode, such as those described herein. The proportional configuration mode that is illustrated (34% is less than the example 35% predefined level, so the device has been configured into a proportional configuration mode) configures the display with the black portions of the display in a powered-off state and the white portions of the display in a powered-on state. White is used to illustrate the portions of the screen that are in a powered-on state in the illustrated embodiment due to the nature of black and white drawings. However, the portions illustrated in white as being in a powered-on state may be displayed in any color or grayscale, in embodiments, while the portion illustrated in black remains in a powered-off state. The color of the portion(s) of the display in the powered-off state may be other colors in other embodiments, due to the particular underlying display technology, for example.

[0235] FIG. 42 illustrates a portable multifunction device 4200 with a display screen 4205 and battery level auto shift value, in accordance with some embodiments. FIG. 42 illustrates a device configured in a proportional configuration mode, due to the battery level auto shift value 4225 reaching a threshold (e.g., a threshold of 20%). In this illustrated embodiment, the available display area 4210 includes the first portion 4215 of the display 4205 that remains in a powered-on state while the second portion 4220 of the display 4205 has been directed into a powered-off state.

[0236] FIGS. 43-45 illustrate that a portion of the display that is in a powered-on state may be anywhere in the display. In some embodiments, the placement of or the amount of area allocated to elements of the user interface may be moved without losing any functionality or access to the applications. For example, a portion of the display that is associated with the menu of icons and the control bar 4350 (e.g., the second portion 4320 of FIG. 43) may be moved anywhere on the display.

[0237] FIG. 43 illustrates a portable multifunction device 4300 with a display screen 4305 and an available display area 4310, in accordance with some embodiments. In FIG. 43, three portions of the display are illustrated. The first portion 4315 and the third portion 4335 are illustrated as in a powered-off state and the second portion 4320 is illustrated as being in a powered-on state in accordance with the device being in a proportional configuration mode. The second por-

tion is illustrated as being in the middle of the display 4305, between the first portion 4315 and the third portion 4335.

[0238] FIG. 44 illustrates a portable multifunction device 4400 with a display screen 4405 and available display area 4410, in accordance with some embodiments. FIG. 44 illustrates that the same icon group illustrated in FIG. 43 may be moved to the bottom of the display 4405, such that the first portion 4415 of the display 4405 is in a powered-off state and the second portion of the display 4405 is in a powered-on state.

[0239] FIG. 45 illustrates a portable multifunction device 4505 with a display screen 4505 and available display area 4510, in accordance with some embodiments. FIG. 45 illustrates that the same icon group illustrated in FIG. 43 may be moved to the top of the display 4505, such that the first portion 4415 of the display 4405 within the available display area 4510 is in a powered-on state and the second portion 4502 of the display 4405 is in a powered-off state.

[0240] The portion of the display that is in the powered-on state may be moved within the display via various methods, such as by dragging via interaction with the user interface (e.g., touch-sensitive surface) or by user configurable settings for example.

[0241] FIG. 46 illustrates a portable multifunction device 4600 with a display screen 4605 and an available display area 4610, in accordance with some embodiments. FIG. 46 illustrates that the icon group illustrated in FIG. 45 may include more icons or other graphic elements than those illustrated in FIG. 45. In some embodiments, the graphic object on the display screen may include hidden elements in addition to the elements that are currently visible via the display. For example, the first full icon visible on the left of the first portion 4615 of the display 4605 is an icon for a radio. In the first portion 4515 of FIG. 45, the radio icon was the last icon on the left. In FIG. 46, the user has interacted with the graphical elements of the screen to make the icons scroll such that hidden icons become visible/available and available/visible icons are hidden. This and other types of graphical elements may provide functionality that reduces the amount of area of the display that is powered-on without losing functionality or access to applications.

#### Example Computer System

[0242] FIG. 47 illustrates computer system 4700 that is configured to execute any or all of the embodiments described above. In different embodiments, computer system 4700 may be any of various types of devices, including, but not limited to, a computer embedded in a vehicle, a computer embedded in an appliance, a personal computer system, desktop computer, laptop, notebook, tablet, slate, or netbook computer, mainframe computer system, handheld computer, workstation, network computer, a camera, a set top box, a mobile device, a consumer device, video game console, handheld video game device, application server, storage device, a television, a video recording device, a peripheral device such as a switch, modem, router, or in general any type of computing or electronic device.

[0243] Various embodiments of a system and method for negotiating control of a shared audio or visual resource, as described herein, may be executed on one or more computer systems 4700, which may interact with various other devices. Note that any component, action, or functionality described above with respect to FIGS. 1-5 may be implemented on one or more computers configured as computer system 4700 of

FIG. 47, according to various embodiments. In the illustrated embodiment, computer system 4700 includes one or more processors 4710 coupled to a system memory 4720 via an input/output (I/O) interface 4730. Computer system 4700 further includes a network interface 4740 coupled to I/O interface 4730, and one or more input/output devices 4750, such as cursor control device 4760, keyboard 4770, and display(s) 4780. In some cases, it is contemplated that embodiments may be implemented using a single instance of computer system 4700, while in other embodiments multiple such systems, or multiple nodes making up computer system 4700, may be configured to host different portions or instances of embodiments. For example, in one embodiment some elements may be implemented via one or more nodes of computer system 4700 that are distinct from those nodes implementing other elements.

[0244] In various embodiments, computer system 4700 may be a uniprocessor system including one processor 4710, or a multiprocessor system including several processors 4710 (e.g., two, four, eight, or another suitable number). Processors 4710 may be any suitable processor capable of executing instructions. For example, in various embodiments processors 4710 may be general-purpose or embedded processors implementing any of a variety of instruction set architectures (ISAs), such as the x86, PowerPC, SPARC, or MIPS ISAs, or any other suitable ISA. In multiprocessor systems, each of processors 4710 may commonly, but not necessarily, implement the same ISA.

[0245] System memory 4720 may be configured to store program instructions 4722 and/or existing state information and ownership transition condition data 4732 accessible by processor 4710. In various embodiments, system memory 4720 may be implemented using any suitable memory technology, such as static random access memory (SRAM), synchronous dynamic RAM (SDRAM), nonvolatile/Flash-type memory, or any other type of memory. In the illustrated embodiment, program instructions 4722 may be configured to implement a mapping application 4724 incorporating any of the functionality described above. Additionally, existing state information and ownership transition condition data 4732 of memory 4720 may include any of the information or data structures described above. In some embodiments, program instructions and/or data may be received, sent or stored upon different types of computer-accessible media or on similar media separate from system memory 4720 or computer system 4700. While computer system 4700 is described as implementing the functionality of functional blocks of previous Figures, any of the functionality described herein may be implemented via such a computer system.

[0246] In one embodiment, I/O interface 4730 may be configured to coordinate I/O traffic between processor 4710, system memory 4720, and any peripheral devices in the device, including network interface 4740 or other peripheral interfaces, such as input/output devices 4750. In some embodiments, I/O interface 4730 may perform any necessary protocol, timing or other data transformations to convert data signals from one component (e.g., system memory 4720) into a format suitable for use by another component (e.g., processor 4710). In some embodiments, I/O interface 4730 may include support for devices attached through various types of peripheral buses, such as a variant of the Peripheral Component Interconnect (PCI) bus standard or the Universal Serial Bus (USB) standard, for example. In some embodiments, the function of I/O interface 4730 may be split into two or more

separate components, such as a north bridge and a south bridge, for example. Also, in some embodiments some or all of the functionality of I/O interface 4730, such as an interface to system memory 4720, may be incorporated directly into processor 4710.

[0247] Network interface 4740 may be configured to allow data to be exchanged between computer system 4700 and other devices attached to a network 4785 (e.g., carrier or agent devices) or between nodes of computer system 4700. Network 4785 may in various embodiments include one or more networks including but not limited to Local Area Networks (LANs) (e.g., an Ethernet or corporate network), Wide Area Networks (WANs) (e.g., the Internet), wireless data networks, some other electronic data network, or some combination thereof. In various embodiments, network interface 4740 may support communication via wired or wireless general data networks, such as any suitable type of Ethernet network, for example; via telecommunications/telephony networks such as analog voice networks or digital fiber communications networks; via storage area networks such as Fibre Channel SANs, or via any other suitable type of network and/or protocol.

[0248] Input/output devices 4750 may, in some embodiments, include one or more display terminals, keyboards, keypads, touchpads, scanning devices, voice or optical recognition devices, or any other devices suitable for entering or accessing data by one or more computer systems 4700. Multiple input/output devices 4750 may be present in computer system 4700 or may be distributed on various nodes of computer system 4700. In some embodiments, similar input/output devices may be separate from computer system 4700 and may interact with one or more nodes of computer system 4700 through a wired or wireless connection, such as over network interface 4740.

[0249] As shown in FIG. 47, memory 4720 may include program instructions 4722, which may be processor-executable to implement any element or action described above. In one embodiment, the program instructions may implement the methods described above, such as the methods illustrated by FIG. 8. In other embodiments, different elements and data may be included. Note that data 4732 may include any data or information described above.

[0250] Those skilled in the art will appreciate that computer system 4700 is merely illustrative and is not intended to limit the scope of embodiments. In particular, the computer system and devices may include any combination of hardware or software that can perform the indicated functions, including computers, network devices, Internet appliances, PDAs, wireless phones, pagers, etc. Computer system 4700 may also be connected to other devices that are not illustrated, or instead may operate as a stand-alone system. In addition, the functionality provided by the illustrated components may in some embodiments be combined in fewer components or distributed in additional components. Similarly, in some embodiments, the functionality of some of the illustrated components may not be provided and/or other additional functionality may be available.

[0251] Those skilled in the art will also appreciate that, while various items are illustrated as being stored in memory or on storage while being used, these items or portions of them may be transferred between memory and other storage devices for purposes of memory management and data integrity. Alternatively, in other embodiments some or all of the software components may execute in memory on another

device and communicate with the illustrated computer system via inter-computer communication. Some or all of the system components or data structures may also be stored (e.g., as instructions or structured data) on a computer-accessible medium or a portable article to be read by an appropriate drive, various examples of which are described above. In some embodiments, instructions stored on a computer-accessible medium separate from computer system 4700 may be transmitted to computer system 4700 via transmission media or signals such as electrical, electromagnetic, or digital signals, conveyed via a communication medium such as a network and/or a wireless link. Various embodiments may further include receiving, sending or storing instructions and/or data implemented in accordance with the foregoing description upon a computer-accessible medium. Generally speaking, a computer-accessible medium may include a non-transitory, computer-readable storage medium or memory medium such as magnetic or optical media, e.g., disk or DVD/CD-ROM, volatile or non-volatile media such as RAM (e.g. SDRAM, DDR, RDRAM, SRAM, etc.), ROM, etc. In some embodiments, a computer-accessible medium may include transmission media or signals such as electrical, electromagnetic, or digital signals, conveyed via a communication medium such as network and/or a wireless link.

[0252] The methods described herein may be implemented in software, hardware, or a combination thereof, in different embodiments. In addition, the order of the blocks of the methods may be changed, and various elements may be added, reordered, combined, omitted, modified, etc. Various modifications and changes may be made as would be obvious to a person skilled in the art having the benefit of this disclosure. The various embodiments described herein are meant to be illustrative and not limiting. Many variations, modifications, additions, and improvements are possible. Accordingly, plural instances may be provided for components described herein as a single instance. Boundaries between various components, operations and data stores are somewhat arbitrary, and particular operations are illustrated in the context of specific illustrative configurations. Other allocations of functionality are envisioned and may fall within the scope of claims that follow. Finally, structures and functionality presented as discrete components in the exemplary configurations may be implemented as a combined structure or component. These and other variations, modifications, additions, and improvements may fall within the scope of embodiments as defined in the claims that follow.

1. A multifunction device comprising:
  - a display comprising a display screen;
  - one or more processors; and
  - a memory comprising program instructions, wherein the program instructions are executed by the one or more processors to implement:
    - a power management module configured to manage a display controller of the multifunction device, wherein to manage the display the power management module is further configured to instruct the display controller to function in a proportional configuration mode, wherein the proportional configuration mode configures a portion of the display screen in a powered-on state and another portion of the display screen in a powered-off state;
 wherein the portion of the display screen that is configured in the powered-on state comprises two or more isolated portions in the powered-on state, the two or

more isolated portions in the powered-on state being non-contiguous with respect to one another and separated by at least some of the portion of the display screen that is in the powered-off state.

2. The multifunction device of claim 1, wherein when the portion of the display screen is in the powered-on state, the portion of the display screen is configured to perform display functions and receive user input.

3. The multifunction device of claim 2, wherein the powered-on state configures the portion of the display screen to function in a grayscale color mode.

4. The multifunction device of claim 3, wherein the powered-off state configures the other portion of the of the display screen to not perform display functions and to not receive user input.

5. The multifunction device of claim 1, wherein the power management module is further configured to instruct the display controller to function in a full display mode, wherein the full display mode configures all of an available area of the display screen in a powered-on state when the display controller of the device is in the full display mode.

6. The multifunction device of claim 1, wherein the power management module is further configured to manage the display of the multifunction device when the display is in a powered-off mode, the power management module configured to direct the display controller to display at least one of a time, date and an indication of one or more messages while the display controller is in the powered-off mode.

7. The multifunction device of claim 1, wherein the power management module is further configured to direct the display controller to transition between modes based on a configurable battery power threshold, wherein the power management module is further configured to:
  - determine that a battery power of the multifunction device reaches the configurable battery power threshold; and
  - subsequent to said determine, instruct the display controller to change from a full configuration mode to the proportional configuration mode.

8. The multifunction device of claim 7, wherein the configurable battery power threshold is a configurable setting in a user interface of the multifunction device.

9. The multifunction device of claim 1, wherein the device is set to a lock state, wherein the display is a touch-sensitive display and wherein the program instructions are further executable by the one or more processors to implement a user interface module configured to:
  - detect a contact with the touch-sensitive display at a first predefined location corresponding to an unlock image;
  - continuously move the unlock image on the touch-sensitive display in accordance with movement of the contact while continuous contact with the display screen is maintained, wherein the unlock image is a graphical, interactive user-interface object with which a user interacts in order to unlock the device;
  - unlock the multifunction device into the proportional configuration mode when the move of the unlock image on the touch-sensitive display results in movement of the unlock image from the first predefined location to a predefined unlock region on the touch-sensitive display; and
  - unlock the multifunction device into the full configuration mode when the move of the unlock image on the touch-sensitive display results in movement of the unlock

image from the first predefined location to another predefined unlock region on the touch-sensitive display.

**10.** A method comprising:

managing a display of a multifunction device, wherein managing the display comprises:

instructing the device to transition from functioning in a full configuration mode to functioning in a proportional configuration mode, wherein the proportional configuration mode configures a portion of a display screen of the device in a powered-on state and another portion of the display screen of the device in a powered-off state;

wherein the portion of the display screen that is configured in the powered-on state comprises two or more isolated portions in the powered-on state, the two or more isolated portions in the powered-on state being non-contiguous with respect to one another and separated by at least some of the portion of the display screen that is in the powered-off state.

**11.** The method of claim **10**, wherein instructing the device to function in a proportional configuration mode causes the other portion of the display to not perform display functions and not receive user input.

**12.** The method of claim **11**, wherein instructing the display to function in a proportional configuration mode causes the portion of the display to perform display functions and receive user input.

**13.** The method of claim **12**, further comprising instructing the display screen to function in a full configuration mode, wherein the full configuration mode configures each portion of the display screen in a powered-on state.

**14.** A multifunction device comprising:

a display screen;

one or more processors; and

a memory comprising program instructions, wherein the program instructions are executable by the one or more processors to implement:

a power management module configured to manage a display screen of the multifunction device, wherein to manage the display screen the power management module is further configured to instruct the display screen to function in a proportional configuration mode, wherein the proportional configuration mode configures a portion of the display screen in a powered-on state and another portion of the display screen in a powered-off state;

wherein the portion of the display screen that is configured in the powered-on state comprises two or more isolated portions in the powered-on state, the two or more isolated portions in the powered-on state being non-contiguous with respect to one another and separated by at least some of the portion of the display screen that is in the powered-off state.

**15.** The multifunction device of claim **14**, wherein the powered-on state of the proportional configuration mode configures the portion of the display to perform display functions and receive user input.

**16.** The multifunction device of claim **15**, wherein the powered-on state of the proportional configuration mode configures the portion of the display to function in a grayscale color mode.

**17.** The multifunction device of claim **16**, wherein the powered-off state of the proportional configuration mode configures the other portion of the of the display screen to not perform display functions and to not receive user input.

**18.** The multifunction device of claim **14**, wherein the power management module is further configured to instruct the display screen to function in a full display mode, wherein the full display mode configures the display in a powered-on state when the display screen of the device is in the display mode.

**19.** The multifunction device of claim **14**, wherein the power management module is further configured to manage the display screen of the multifunction device when the display screen is in a sleep mode, the power management module configured to direct the display screen to display at least one of a time, date and an indication of one or more messages while the display screen controller is in the sleep mode.

**20.** The multifunction device of claim **14**, wherein the power management module is further configured to direct the display screen to change between modes based on a configurable battery power threshold, wherein the power management module is further configured to:

determine that a battery power of the multifunction device has reached the configurable battery power threshold; and

subsequent to said determine, instruct the display screen to shift from full configuration mode to the proportional configuration mode.

\* \* \* \* \*