



(19) **United States**
(12) **Patent Application Publication**
Bequet et al.

(10) **Pub. No.: US 2023/0289218 A9**
(48) **Pub. Date: Sep. 14, 2023**
CORRECTED PUBLICATION

(54) **AUTOMATED VIRTUAL MACHINE RESOURCE MANAGEMENT IN CONTAINER-SUPPORTED MANY TASK COMPUTING**

(71) Applicant: **SAS Institute Inc.**, Cary, NC (US)

(72) Inventors: **Henry Gabriel Victor Bequet**, Cary, NC (US); **Ronald Earl Stogner**, Cary, NC (US); **Eric Jian Yang**, Morrisville, NC (US); **Chaowang "Ricky" Zhang**, Morrisville, NC (US)

(73) Assignee: **SAS Institute Inc.**, Cary, NC (US)

(21) Appl. No.: **17/733,090**

(22) Filed: **Apr. 29, 2022**

Prior Publication Data

(15) Correction of US 2022/0253335 A1 Aug. 11, 2022 See (63) and (60) Related U.S. Application Data.

(65) US 2022/0253335 A1 Aug. 11, 2022

Related U.S. Application Data

(63) Continuation-in-part of application No. 17/682,783, filed on Feb. 28, 2022, now Pat. No. 11,474,863, which is a continuation-in-part of application No. 17/563,697, filed on Dec. 28, 2021, now Pat. No. 11,513,850, said application No. 17/563,697 is a continuation of application No. 17/558,237, filed on Dec. 21, 2021, now Pat. No. 11,455,190, which is a continuation-in-part of application No. 17/308,355, filed on May 5, 2021, now Pat. No. 11,204,809, said application No. 17/308,355 is a continuation of application No. 17/225,023, filed on Apr. 7, 2021, now Pat. No. 11,169,788, which is a continuation-in-part of application No. 17/139,364, filed on Dec. 31, 2020, now Pat. No. 11,144,293, which is a continuation-in-

part of application No. 17/064,577, filed on Oct. 6, 2020, now Pat. No. 11,080,031, which is a continuation-in-part of application No. 16/814,481, filed on Mar. 10, 2020, now Pat. No. 10,795,935, which is a continuation-in-part of application No. 16/708,179, filed on Dec. 9, 2019, now Pat. No. 10,740,076, which is a continuation-in-part of application No. 16/587,965, filed on Sep. 30, 2019, now Pat. No. 10,650,046, which is a continuation-in-part of application No. 16/556,573, filed on Aug. 30, 2019, now Pat. No. 10,650,045, said application No. 16/556,573 is a continuation-in-part of application No. 16/539,222, filed on Aug. 13, 2019, now Pat. No.

(Continued)

Publication Classification

(51) **Int. Cl.**
G06F 9/48 (2006.01)
H05B 6/06 (2006.01)
H05B 6/12 (2006.01)
(52) **U.S. Cl.**
CPC **G06F 9/4881** (2013.01); **H05B 6/062** (2013.01); **H05B 6/1272** (2013.01); **G06F 9/485** (2013.01)

(57) **ABSTRACT**

An apparatus includes a processor to: receive a request to perform a job flow; within a performance container, based on the data dependencies among a set of tasks of the job flow, derive an order of performance of the set of tasks that includes a subset able to be performed in parallel, and derive a quantity of task containers to enable the parallel performance of the subset; based on the derived quantity of task containers, derive a quantity of virtual machines (VMs) to enable the parallel performance of the subset; provide, to a VM allocation routine, an indication of a need for provision of the quantity of VMs; and store, within a task queue, multiple task routine execution request messages to enable parallel execution of task routines within the quantity of task containers to cause the parallel performance of the subset.

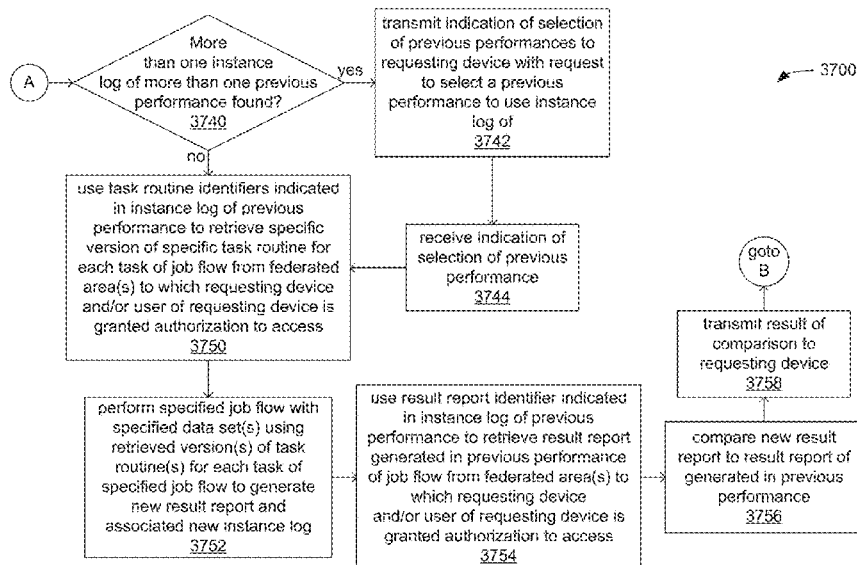

Related U.S. Application Data

- 10,649,750, said application No. 16/539,222 is a continuation of application No. 16/538,734, filed on Aug. 12, 2019, now Pat. No. 10,642,896, which is a continuation-in-part of application No. 16/223,518, filed on Dec. 18, 2018, now Pat. No. 10,380,185, which is a continuation-in-part of application No. 16/205,424, filed on Nov. 30, 2018, now Pat. No. 10,346,476, which is a continuation-in-part of application No. 15/897,723, filed on Feb. 15, 2018, now Pat. No. 10,331,495, which is a continuation-in-part of application No. 16/236,401, filed on Dec. 29, 2018, now Pat. No. 10,409,863, which is a continuation-in-part of application No. 16/039,745, filed on Jul. 19, 2018, now Pat. No. 10,360,069, which is a continuation-in-part of application No. 15/897,723, filed on Feb. 15, 2018, now Pat. No. 10,331,495, which is a continuation-in-part of application No. 15/896,613, filed on Feb. 14, 2018, now Pat. No. 10,002,029, which is a continuation-in-part of application No. 15/851,869, filed on Dec. 22, 2017, now Pat. No. 10,078,710, which is a continuation of application No. 15/613,516, filed on Jun. 5, 2017, now Pat. No. 9,852,013, which is a continuation of application No. 15/425,886, filed on Feb. 6, 2017, now Pat. No. 9,684,544, which is a continuation of application No. 15/425,749, filed on Feb. 6, 2017, now Pat. No. 9,684,543.
- (60) Provisional application No. 63/157,419, filed on Mar. 5, 2021, provisional application No. 63/159,428, filed on Mar. 10, 2021, provisional application No. 63/185,570, filed on May 7, 2021, provisional application No. 63/252,070, filed on Oct. 4, 2021, provisional application No. 63/139,703, filed on Jan. 20, 2021, provisional application No. 63/157,419, filed on Mar. 5, 2021, provisional application No. 63/159,428, filed on Mar. 10, 2021, provisional application No. 63/185,570, filed on May 7, 2021, provisional application No. 63/252,070, filed on Oct. 4, 2021, provisional application No. 63/006,516, filed on Apr. 7, 2020, provisional application No. 63/008,830, filed on Apr. 13, 2020, provisional application No. 63/015,274, filed on Apr. 24, 2020, provisional application No. 63/029,989, filed on May 26, 2020, provisional application No. 62/972,240, filed on Feb. 10, 2020, provisional application No. 62/985,455, filed on Mar. 5, 2020, provisional application No. 62/816,160, filed on Mar. 10, 2019, provisional application No. 62/776,691, filed on Dec. 7, 2018, provisional application No. 62/739,314, filed on Sep. 30, 2018, provisional application No. 62/725,186, filed on Aug. 30, 2018, provisional application No. 62/717,873, filed on Aug. 12, 2018, provisional application No. 62/654,643, filed on Apr. 9, 2018, provisional application No. 62/631,462, filed on Feb. 15, 2018, provisional application No. 62/801,173, filed on Feb. 5, 2019, provisional application No. 62/689,040, filed on Jun. 22, 2018, provisional application No. 62/534,678, filed on Jul. 19, 2017, provisional application No. 62/560,506, filed on Sep. 19, 2017, provisional application No. 62/460,000, filed on Feb. 16, 2017, provisional application No. 62/297,454, filed on Feb. 19, 2016, provisional application No. 62/292,078, filed on Feb. 5, 2016, provisional application No. 63/006,516, filed on Apr. 7, 2020, provisional application No. 63/008,830, filed on Apr. 13, 2020, provisional application No. 63/015,274, filed on Apr. 24, 2020, provisional application No. 63/029,989, filed on May 26, 2020.

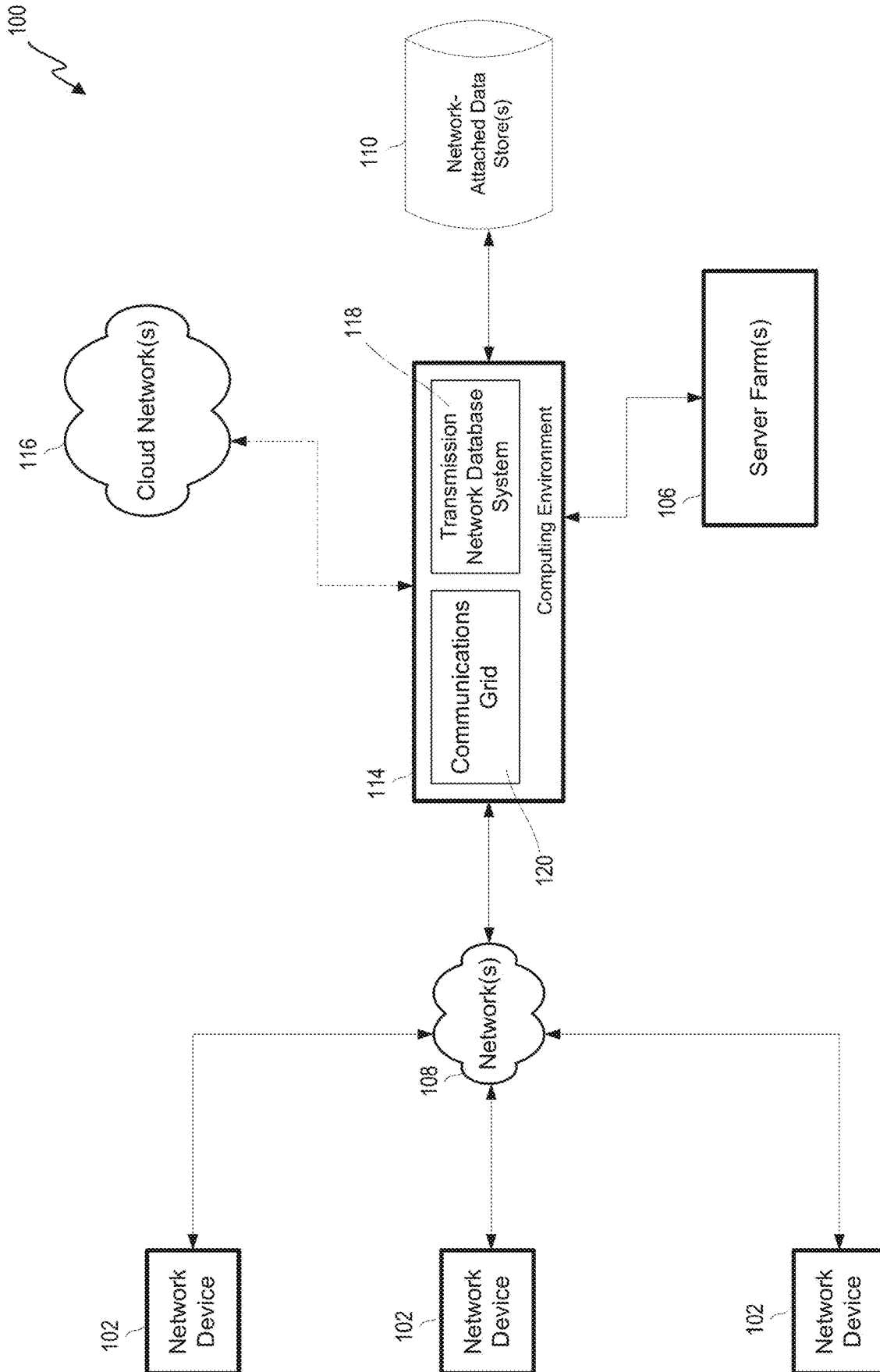

FIG. 1

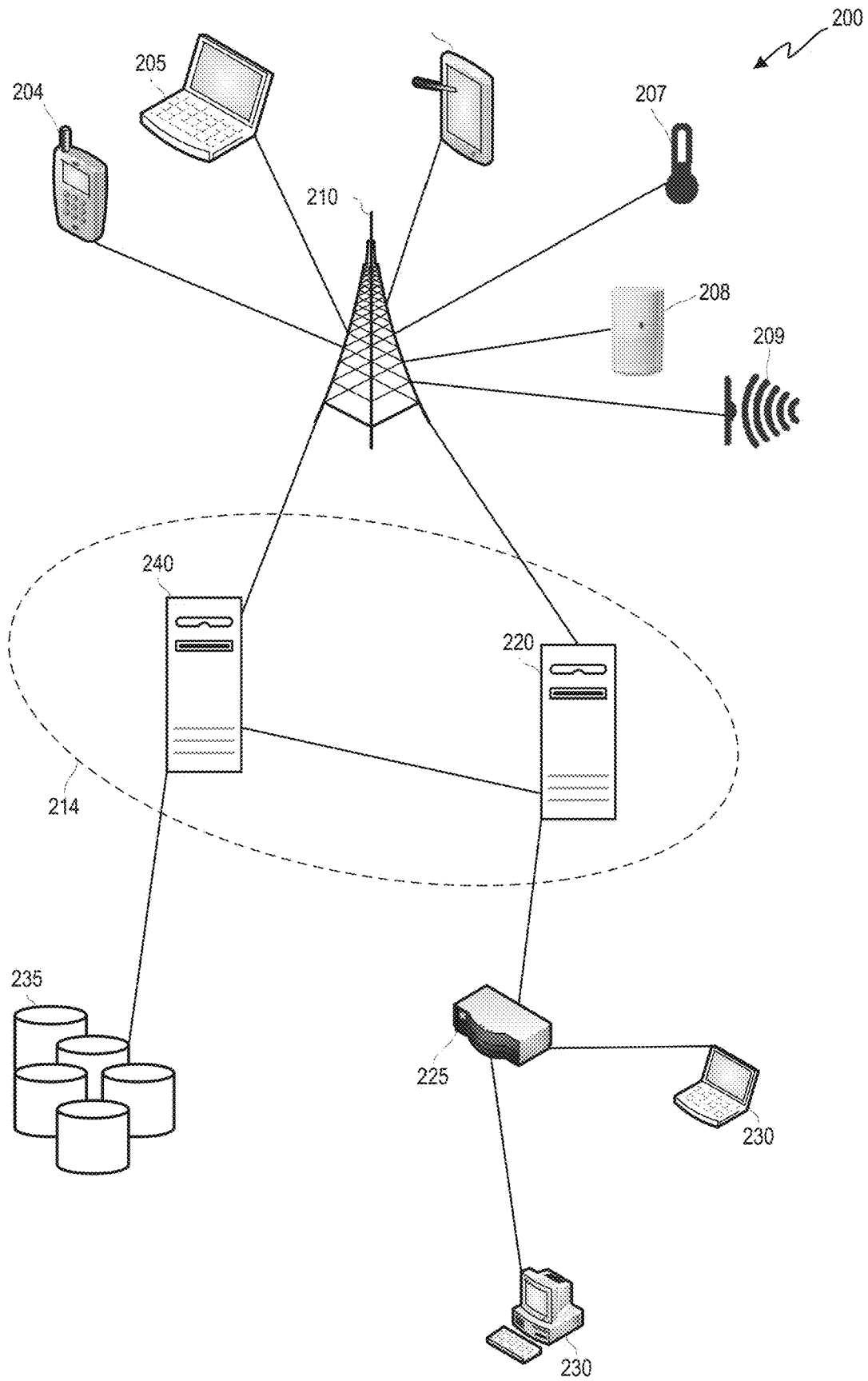

FIG. 2

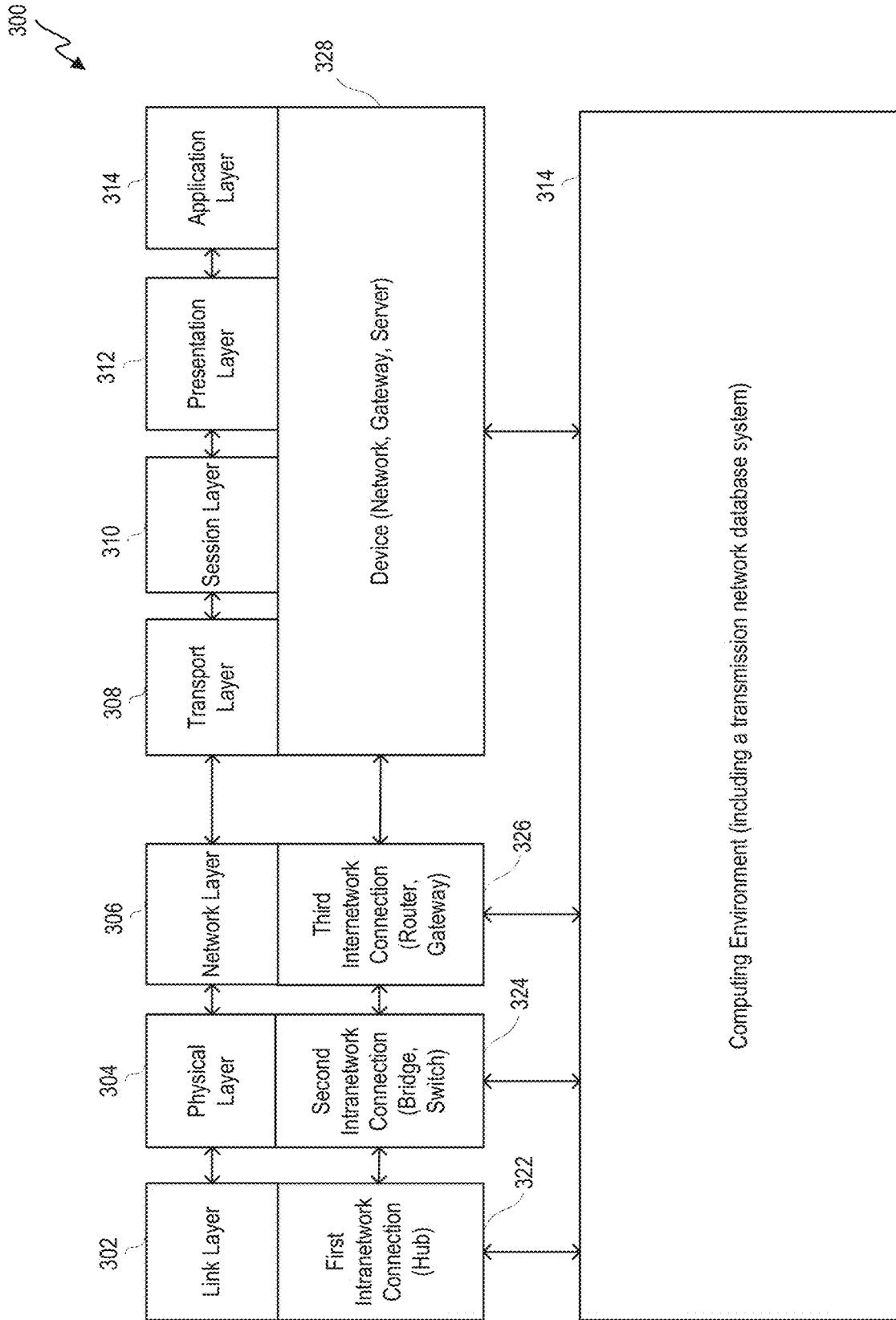

FIG. 3

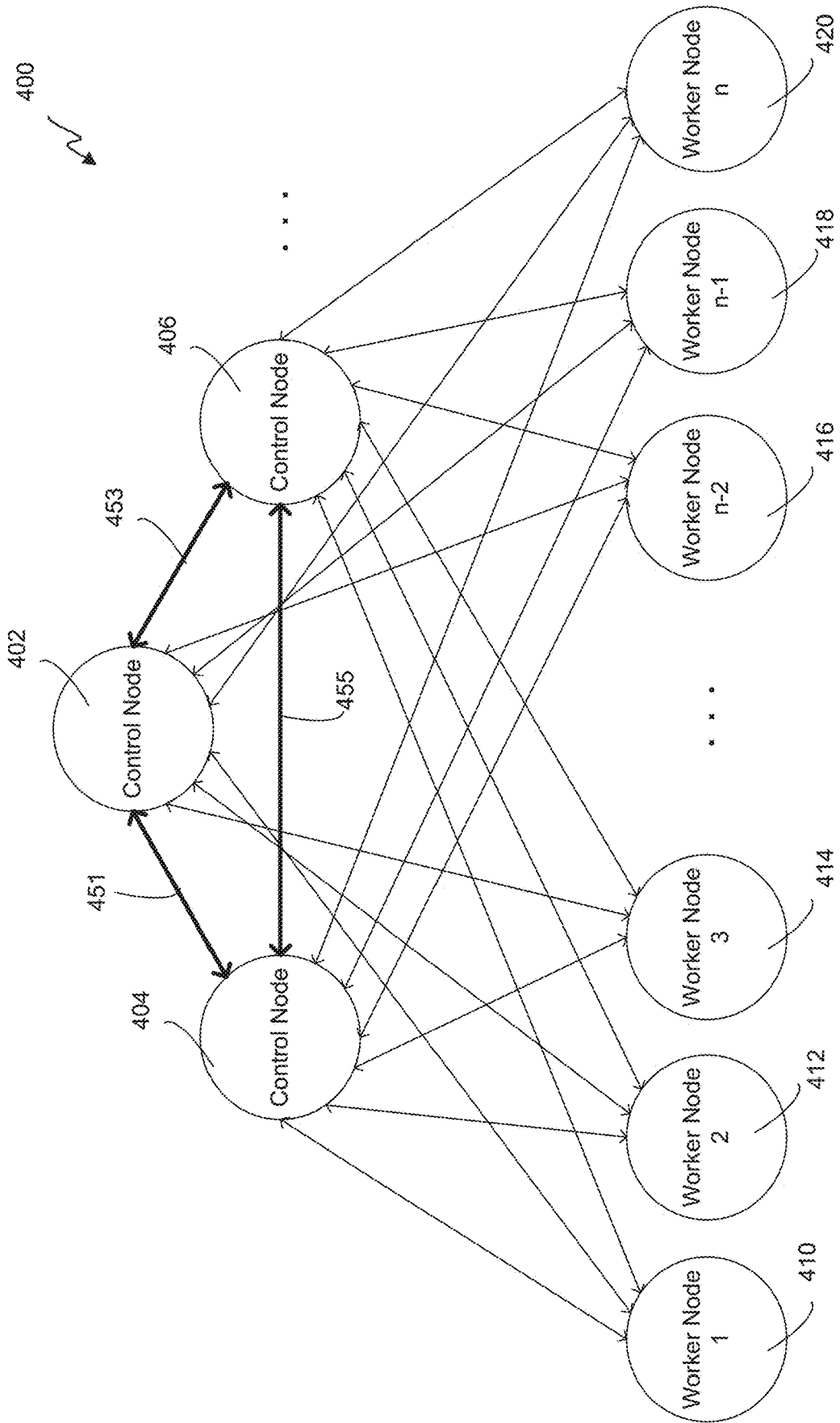

FIG. 4

500

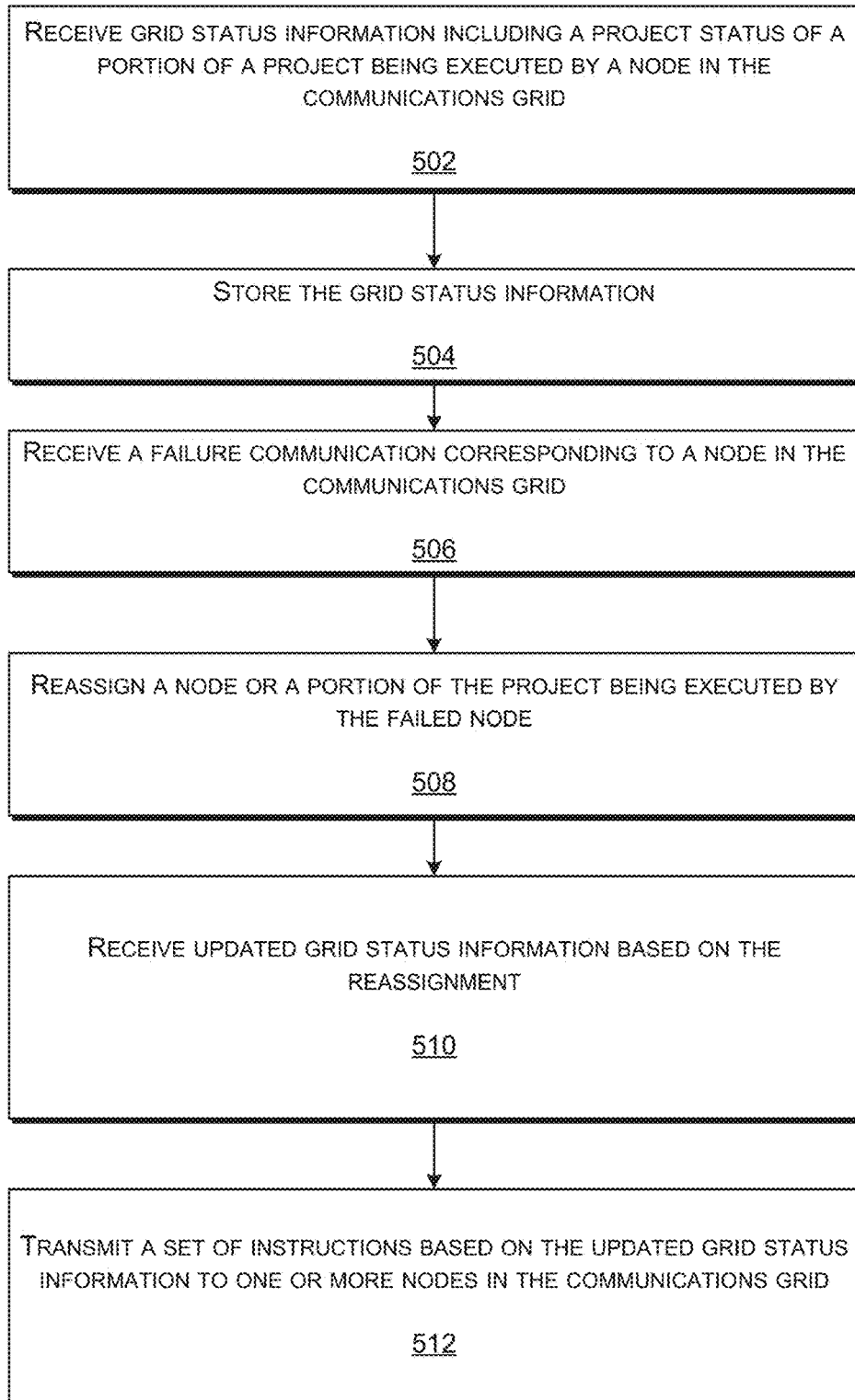

FIG. 5

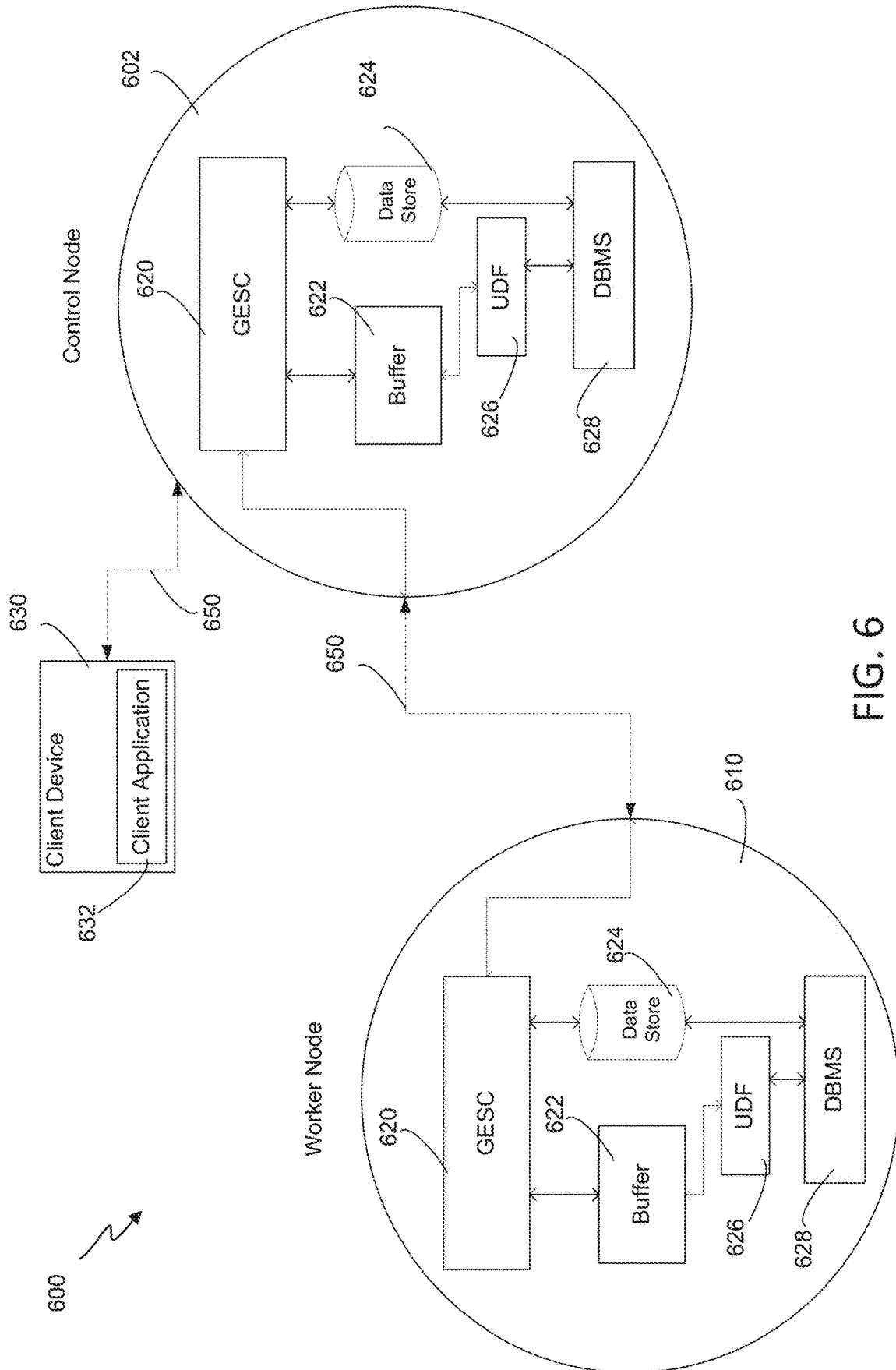

FIG. 6

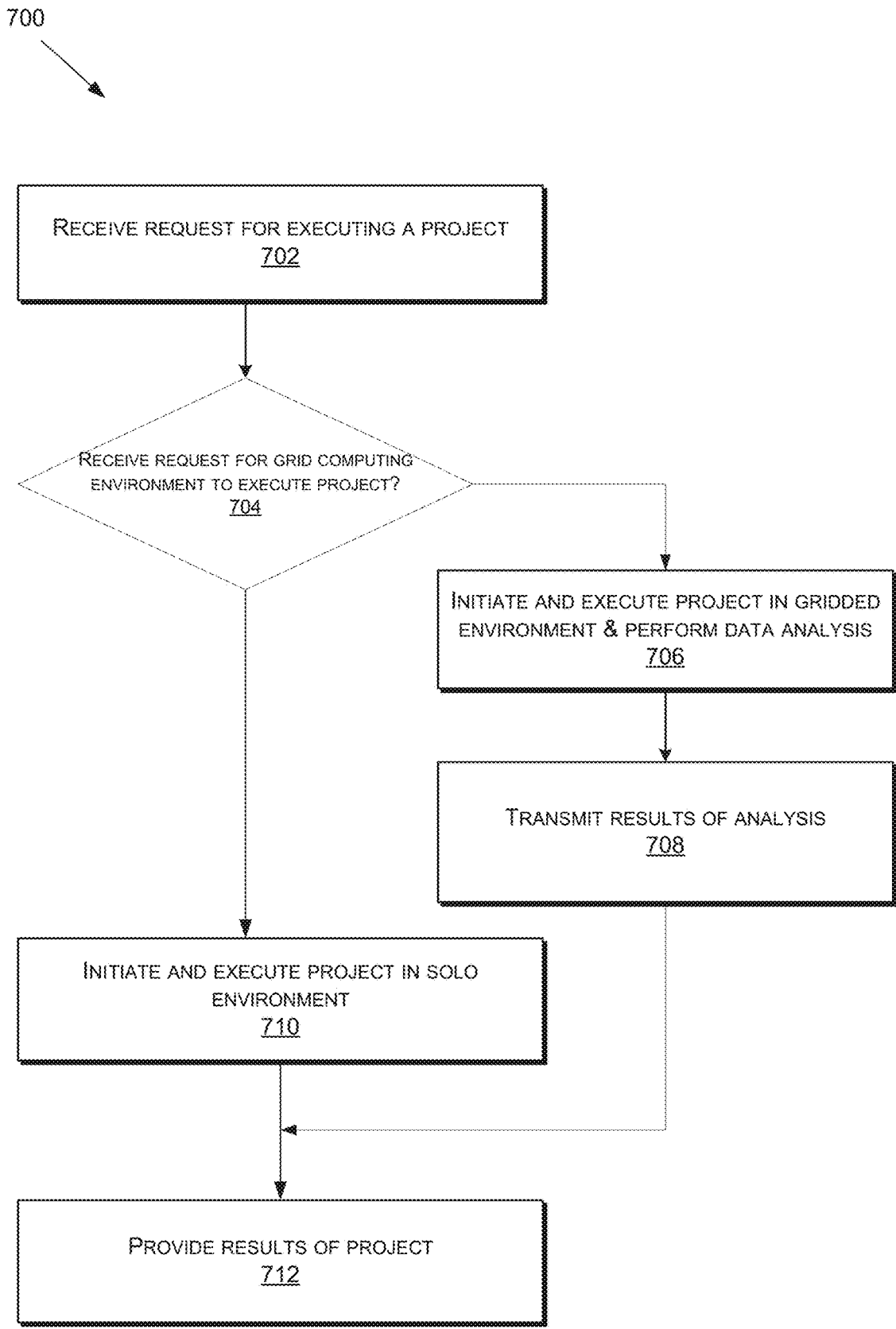

FIG. 7

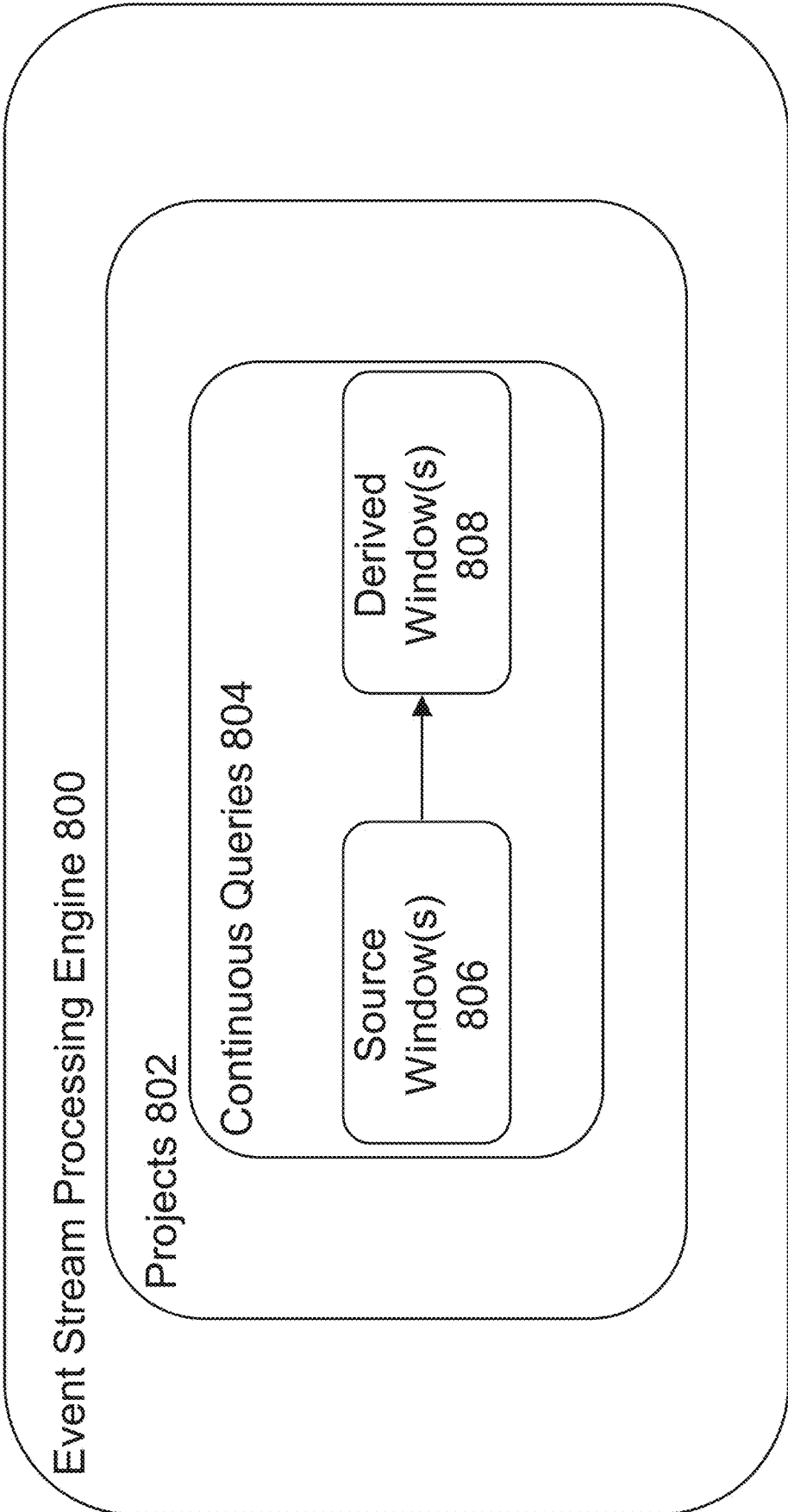

FIG. 8

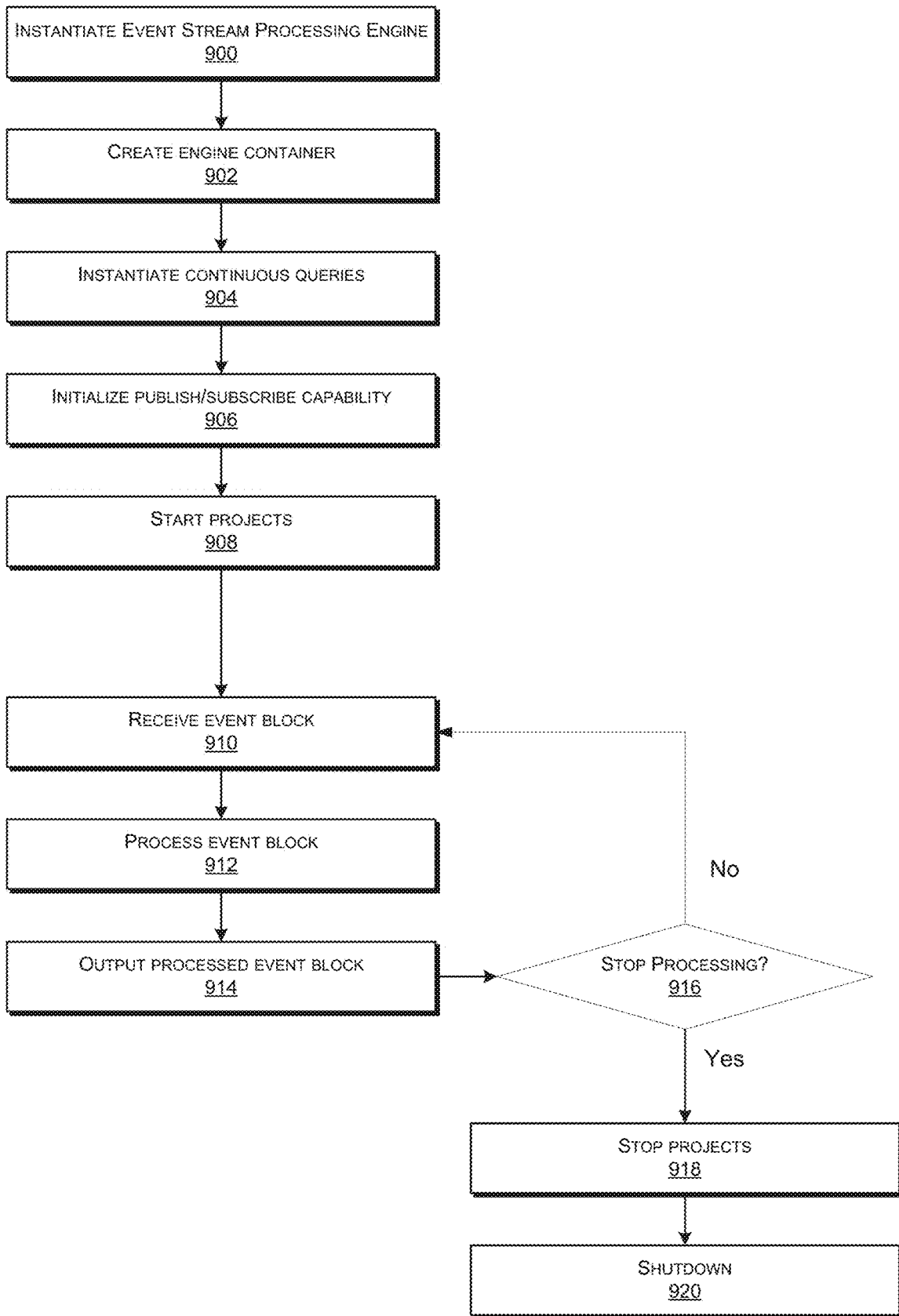

FIG. 9

1000 ↗

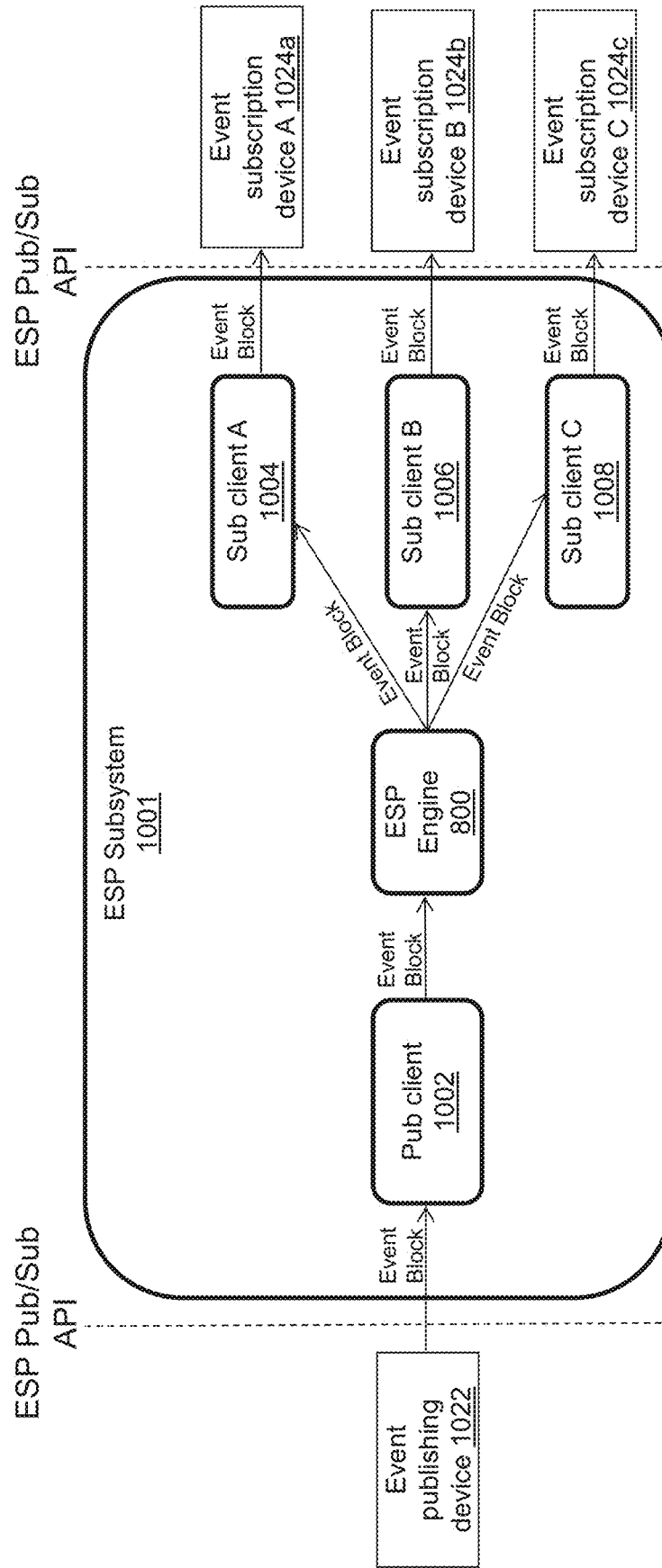

FIG. 10

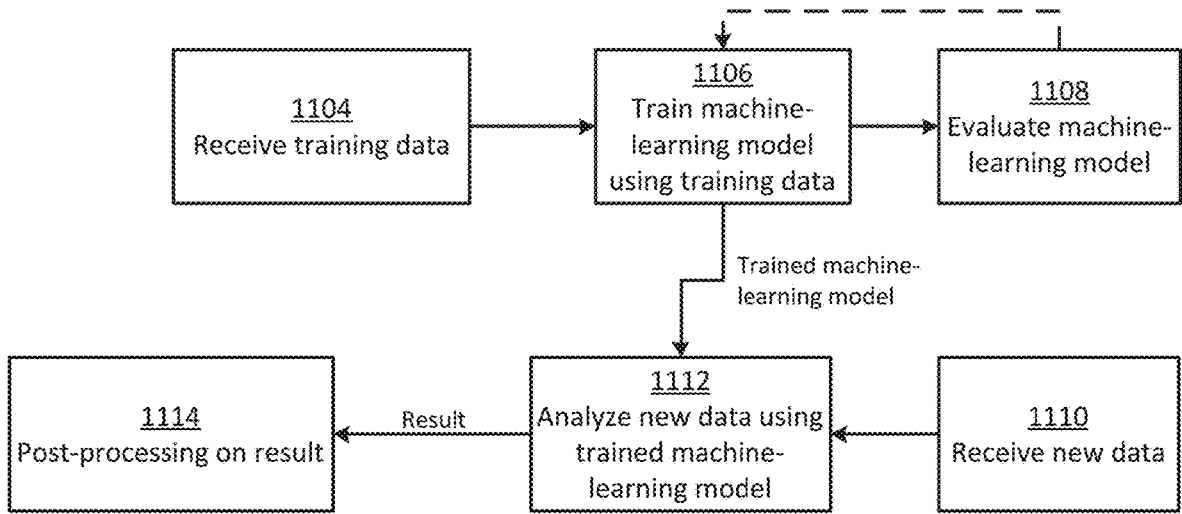

FIG. 11

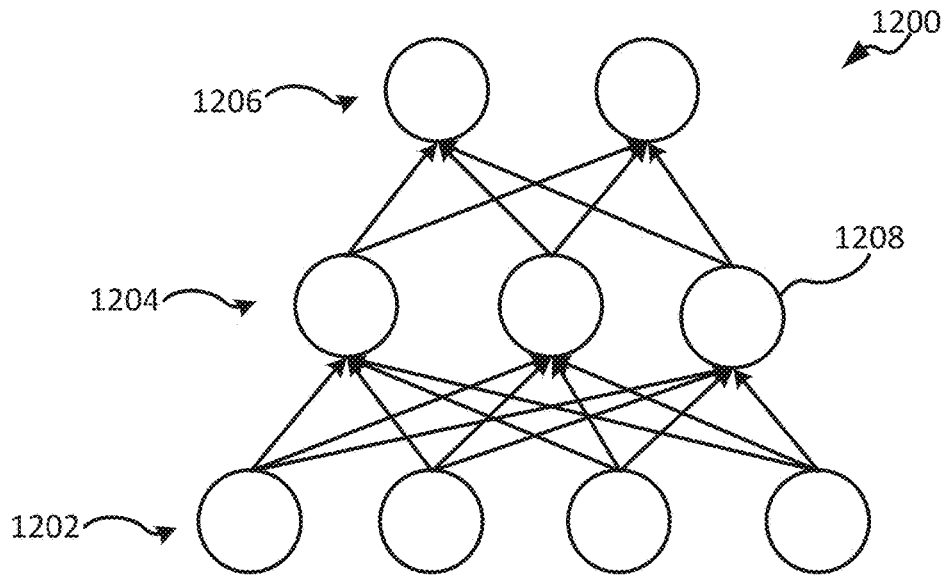

FIG. 12

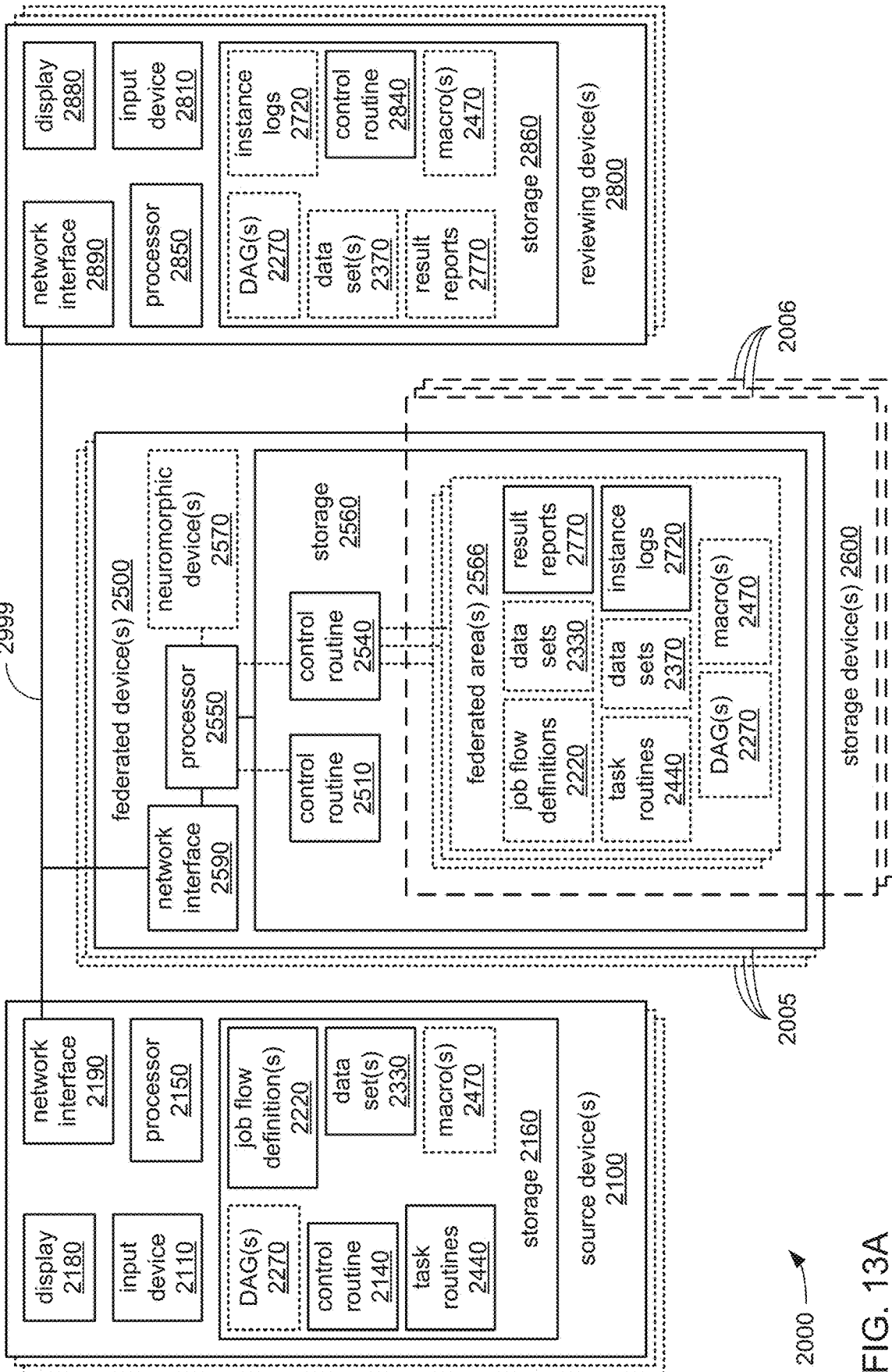

FIG. 13A

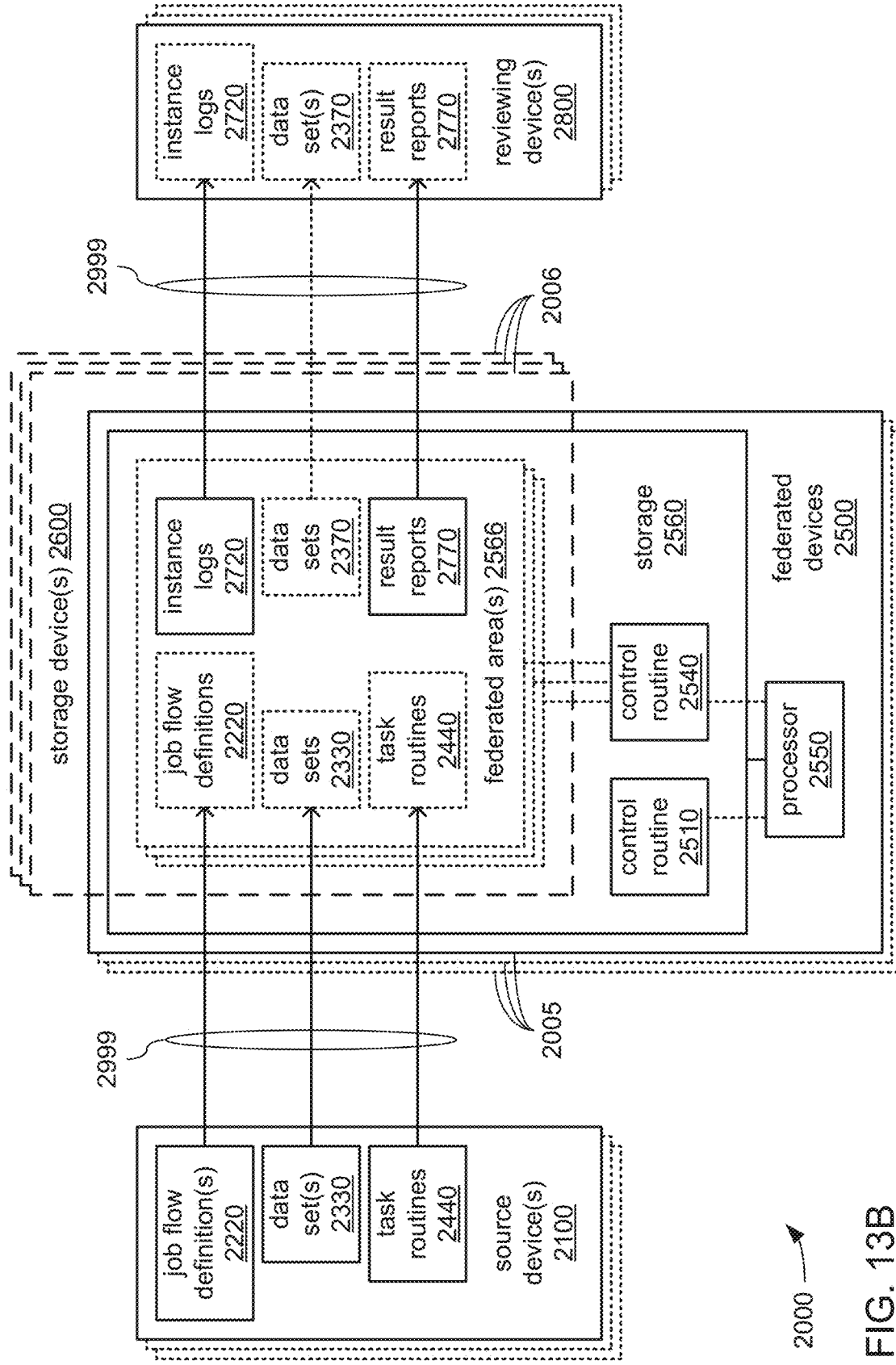
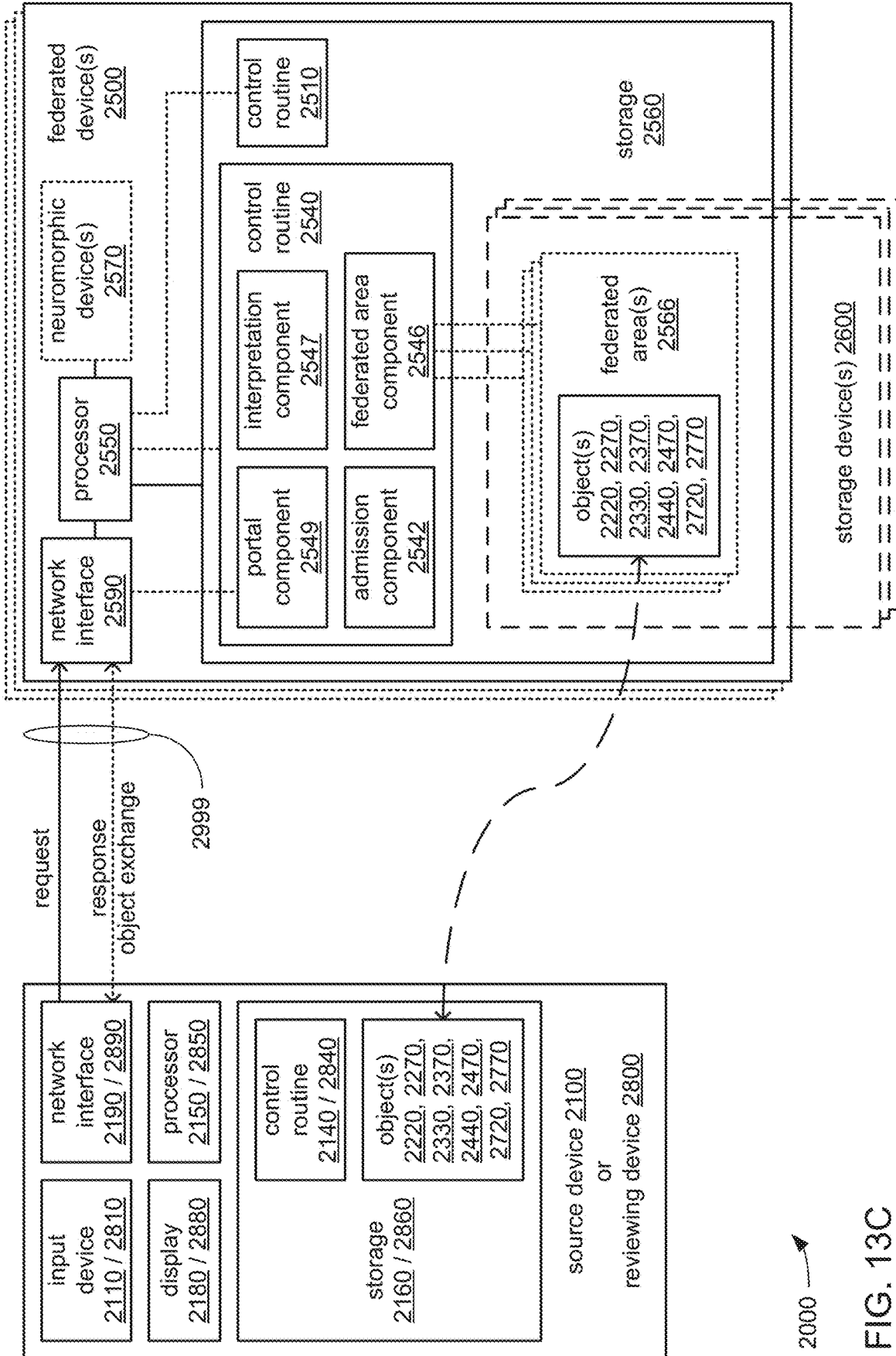

FIG. 13B



2000 →
FIG. 13C

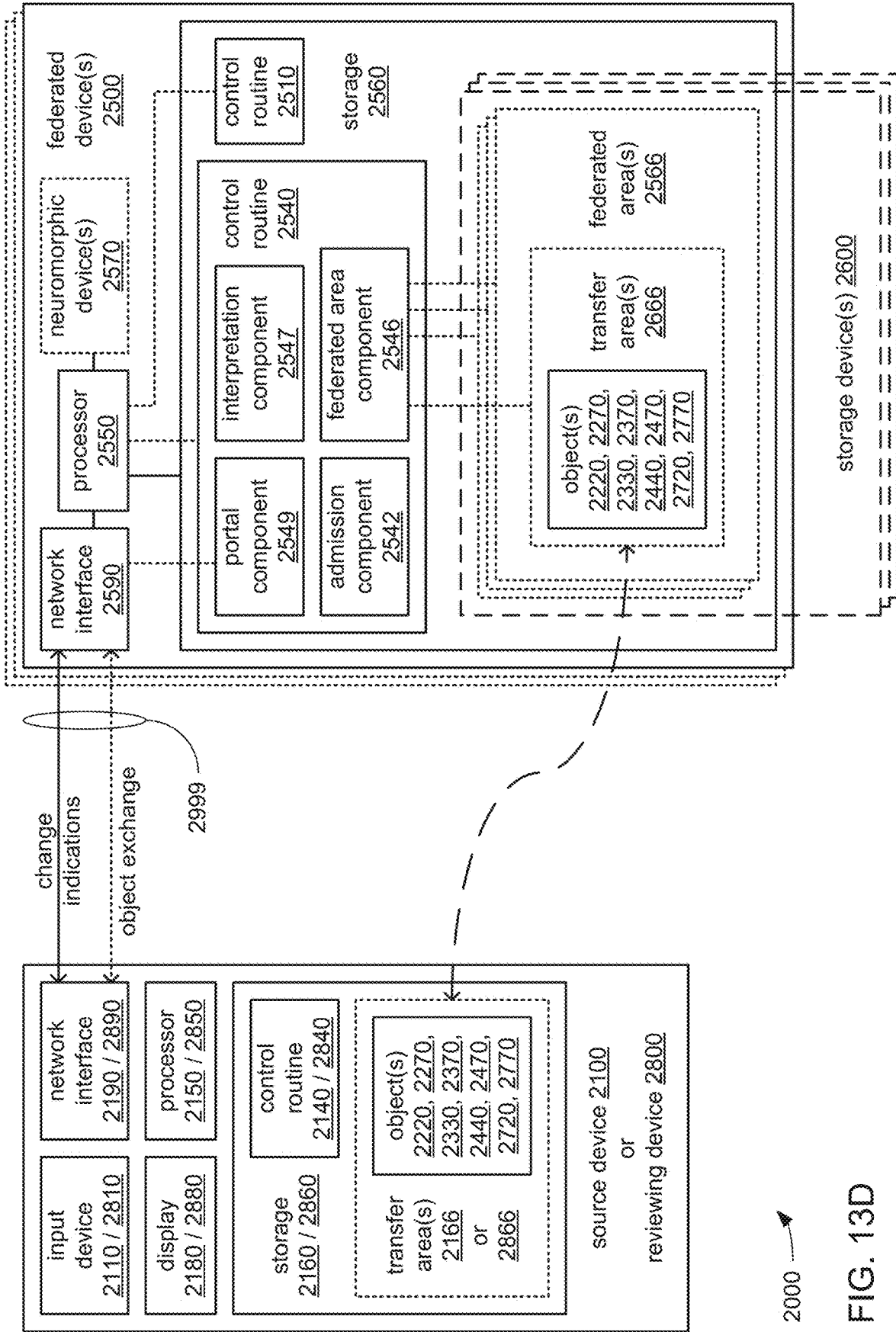

FIG. 13D

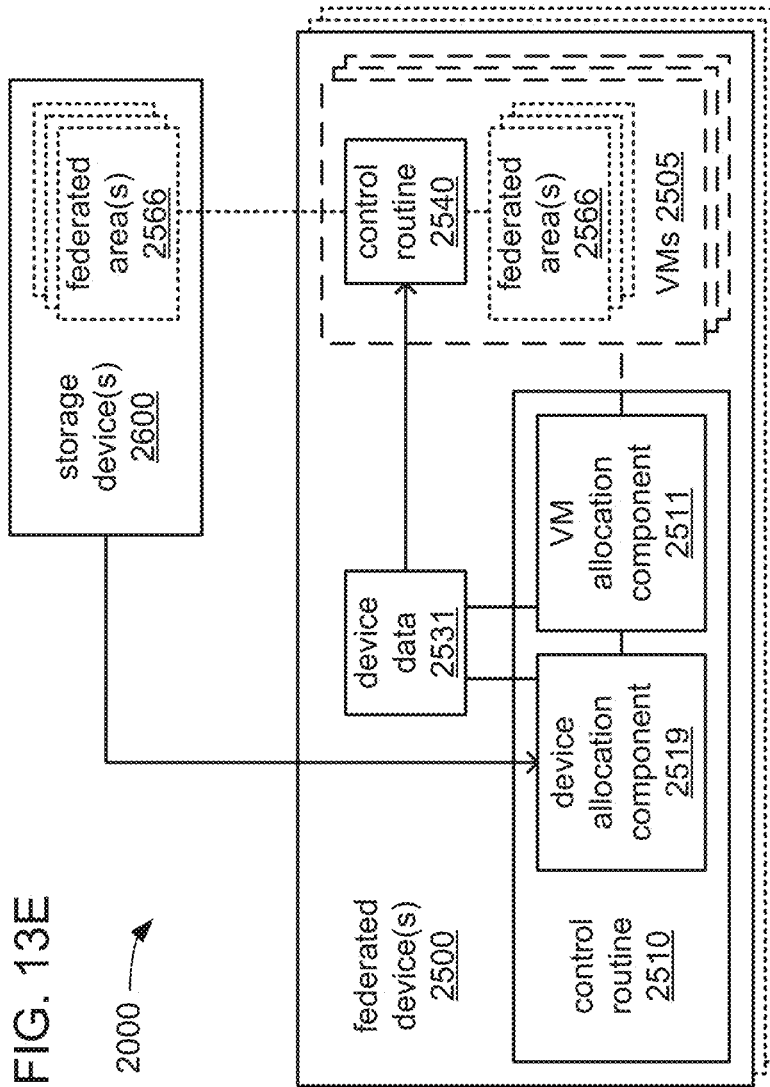
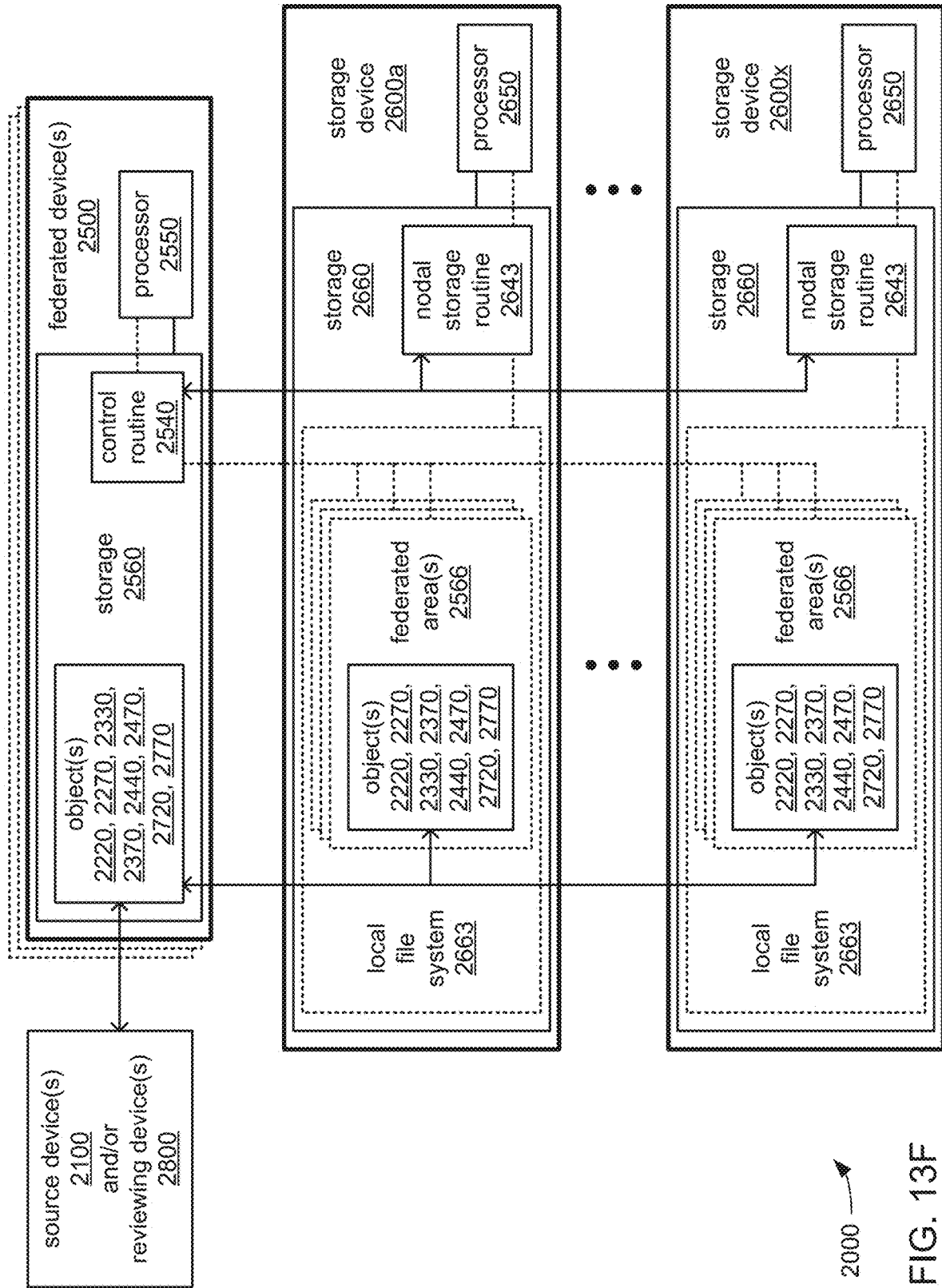
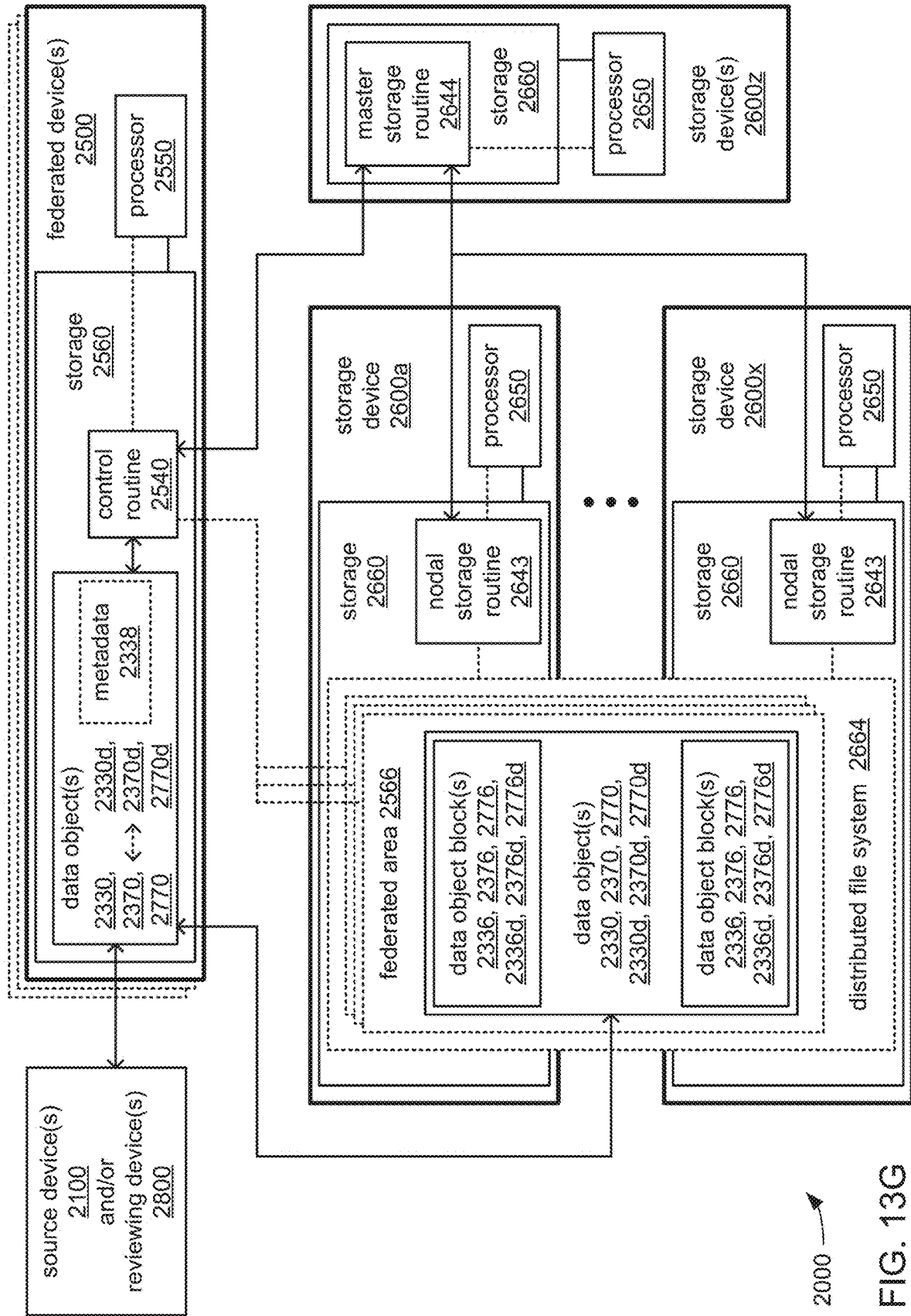

FIG. 13E

2000



2000 →
FIG. 13F



2000 →
FIG. 13G

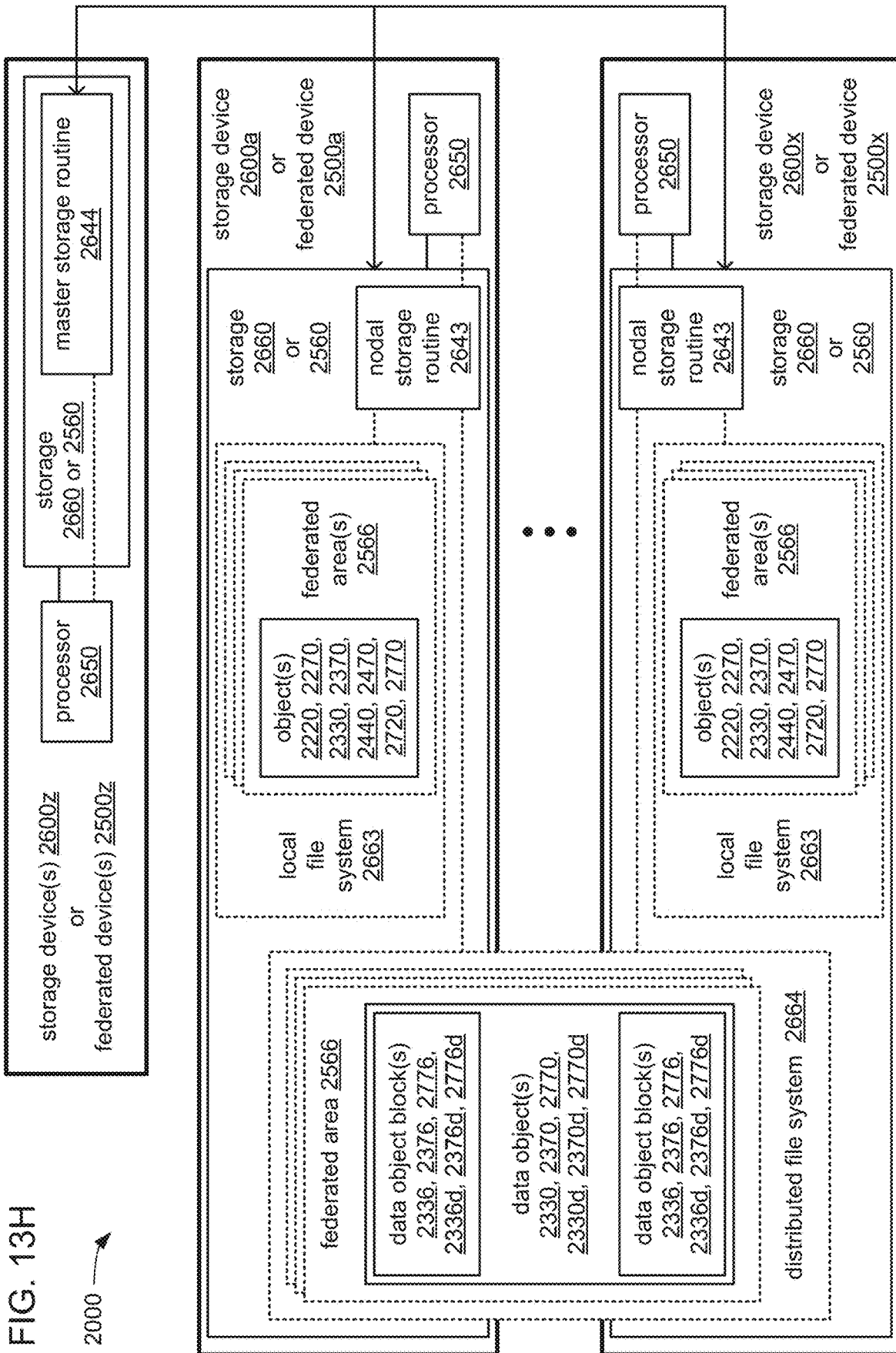

FIG. 13H

2000

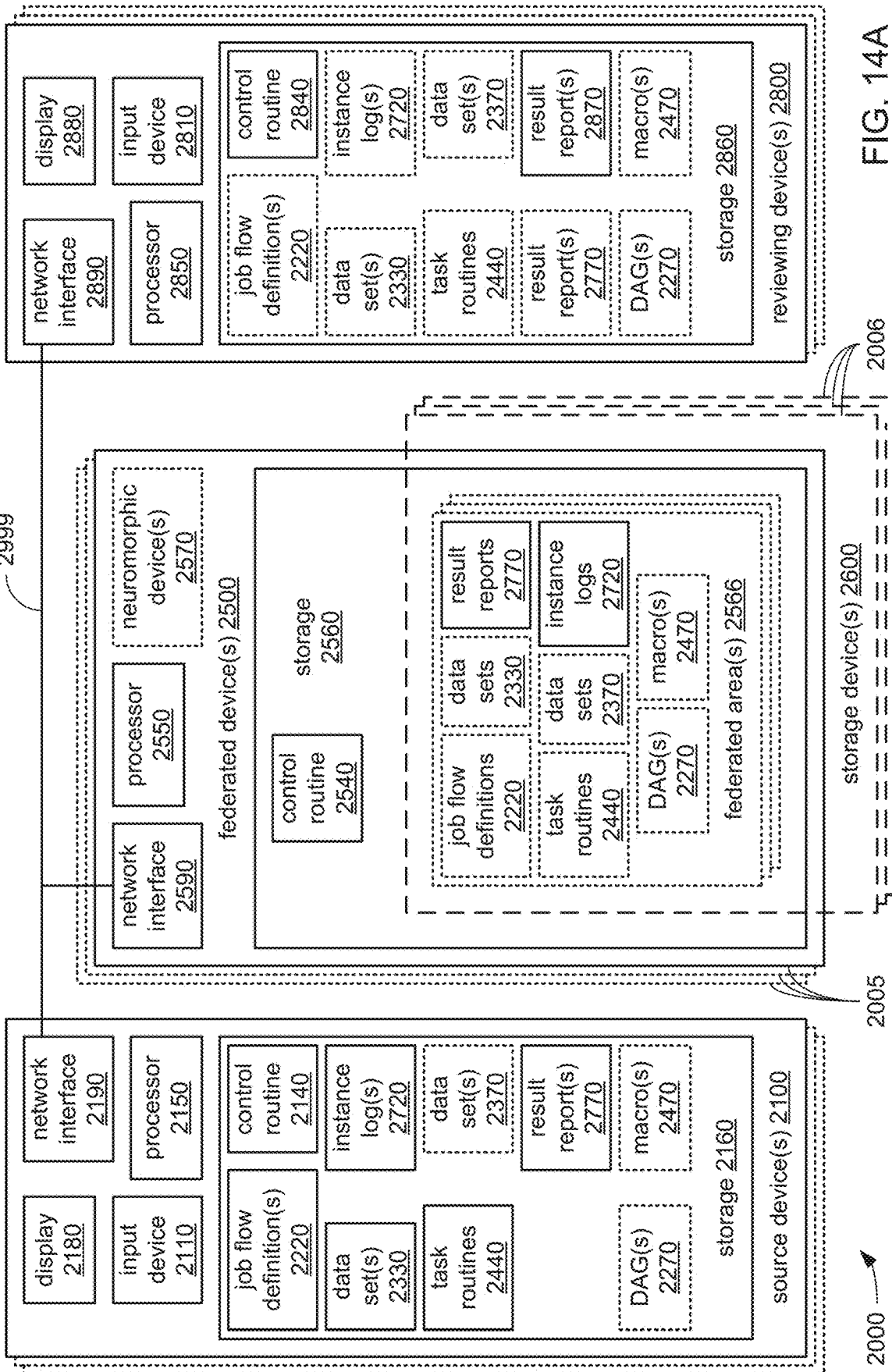

FIG. 14A

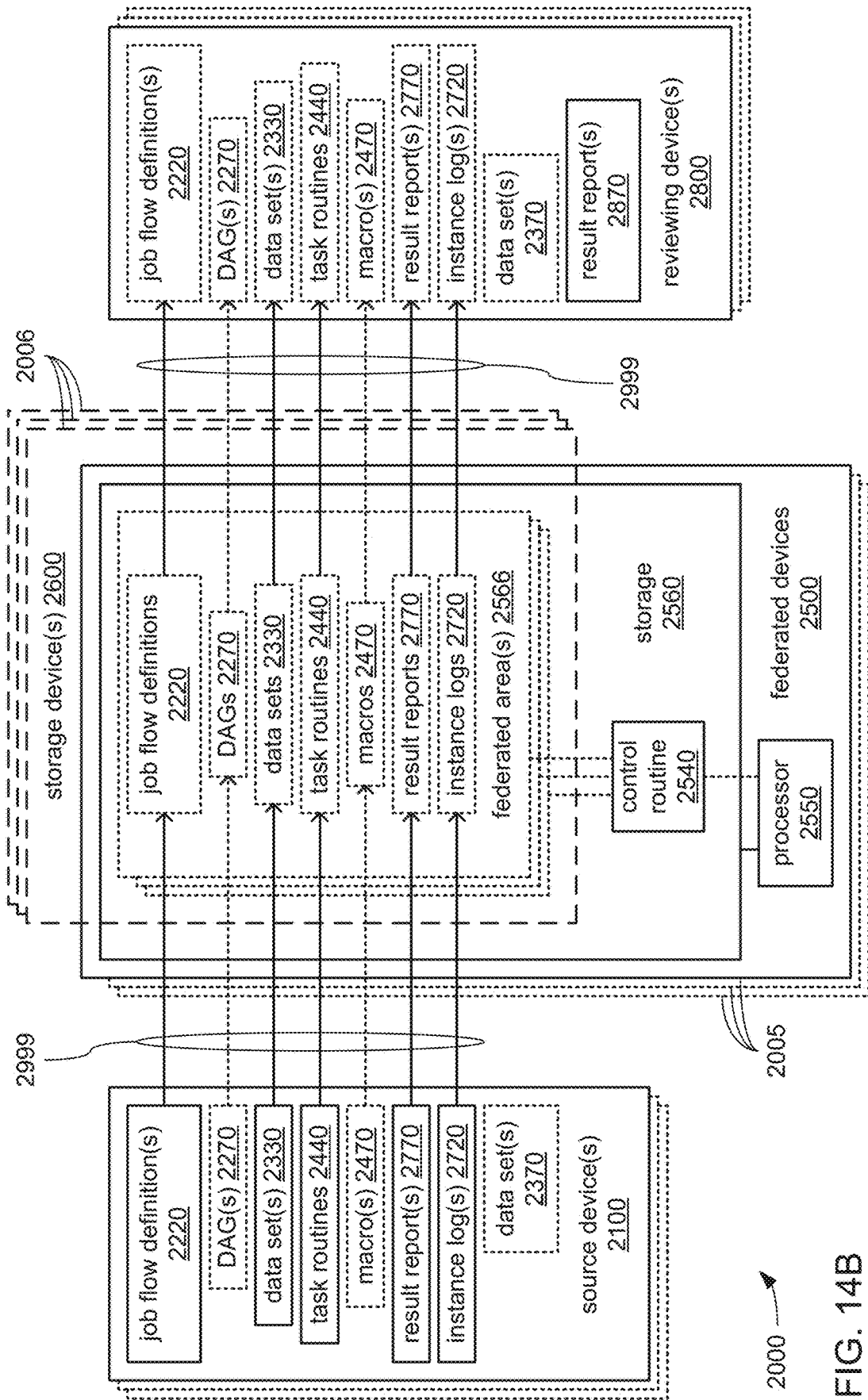

FIG. 14B

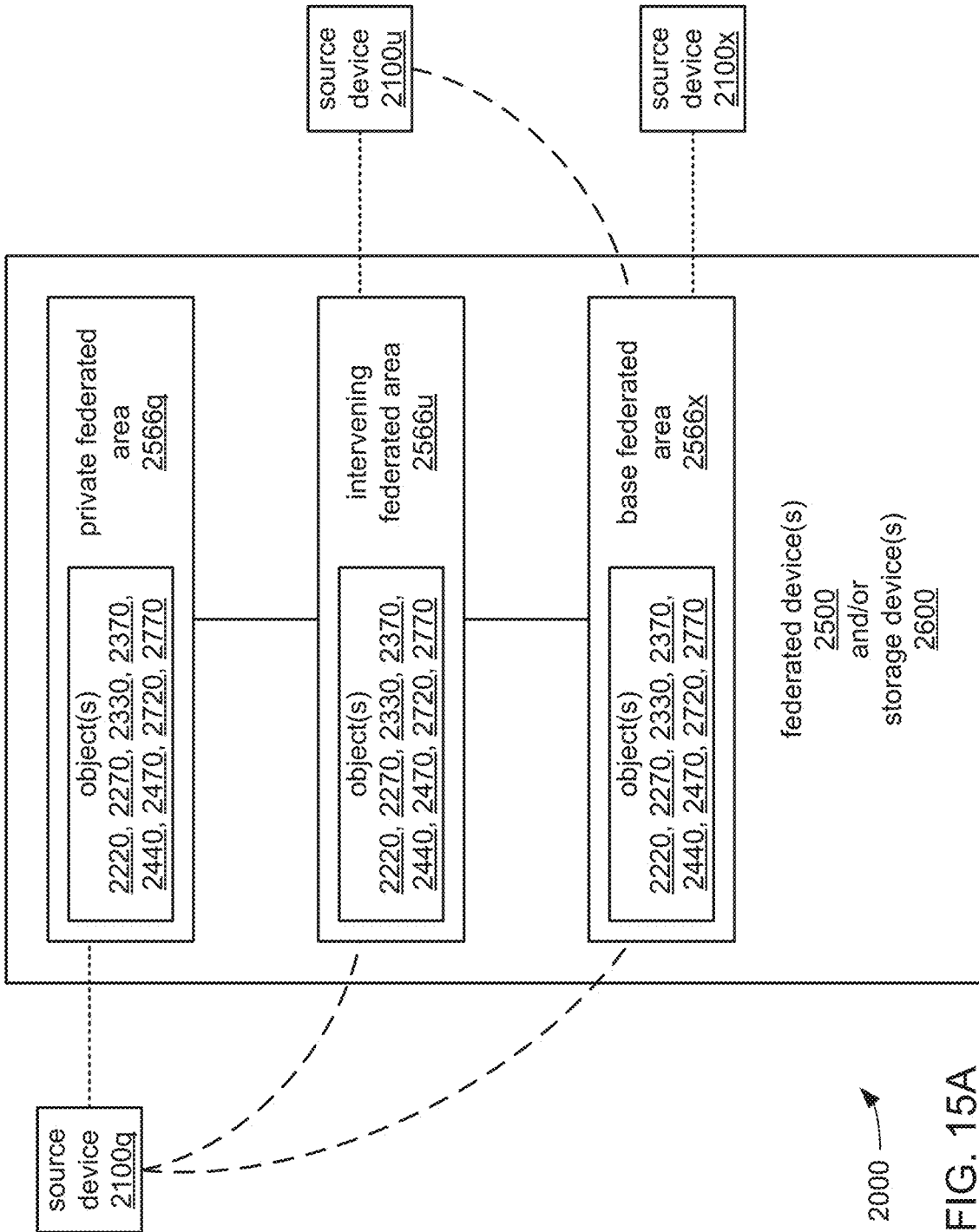
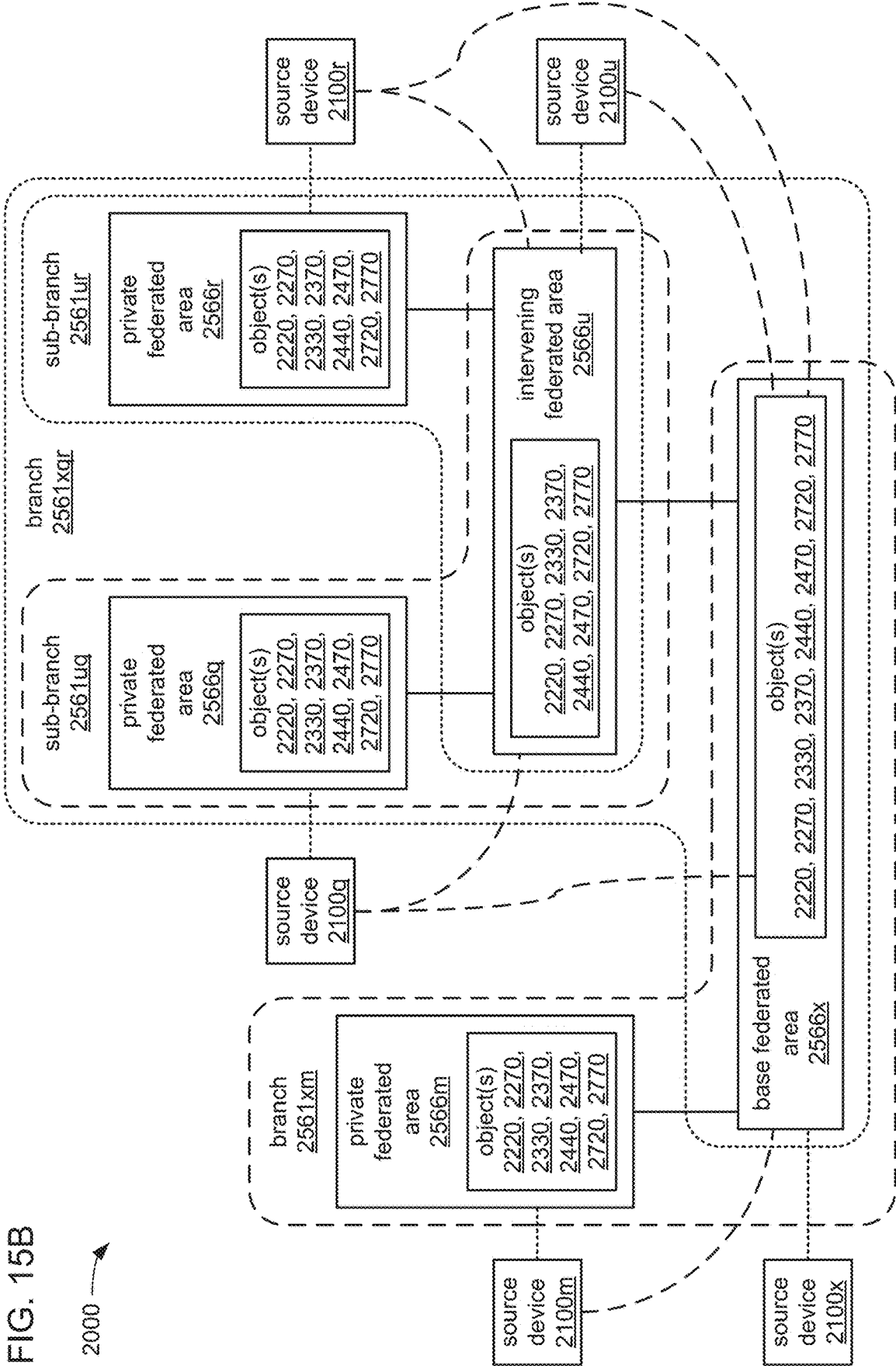

FIG. 15A

FIG. 15B



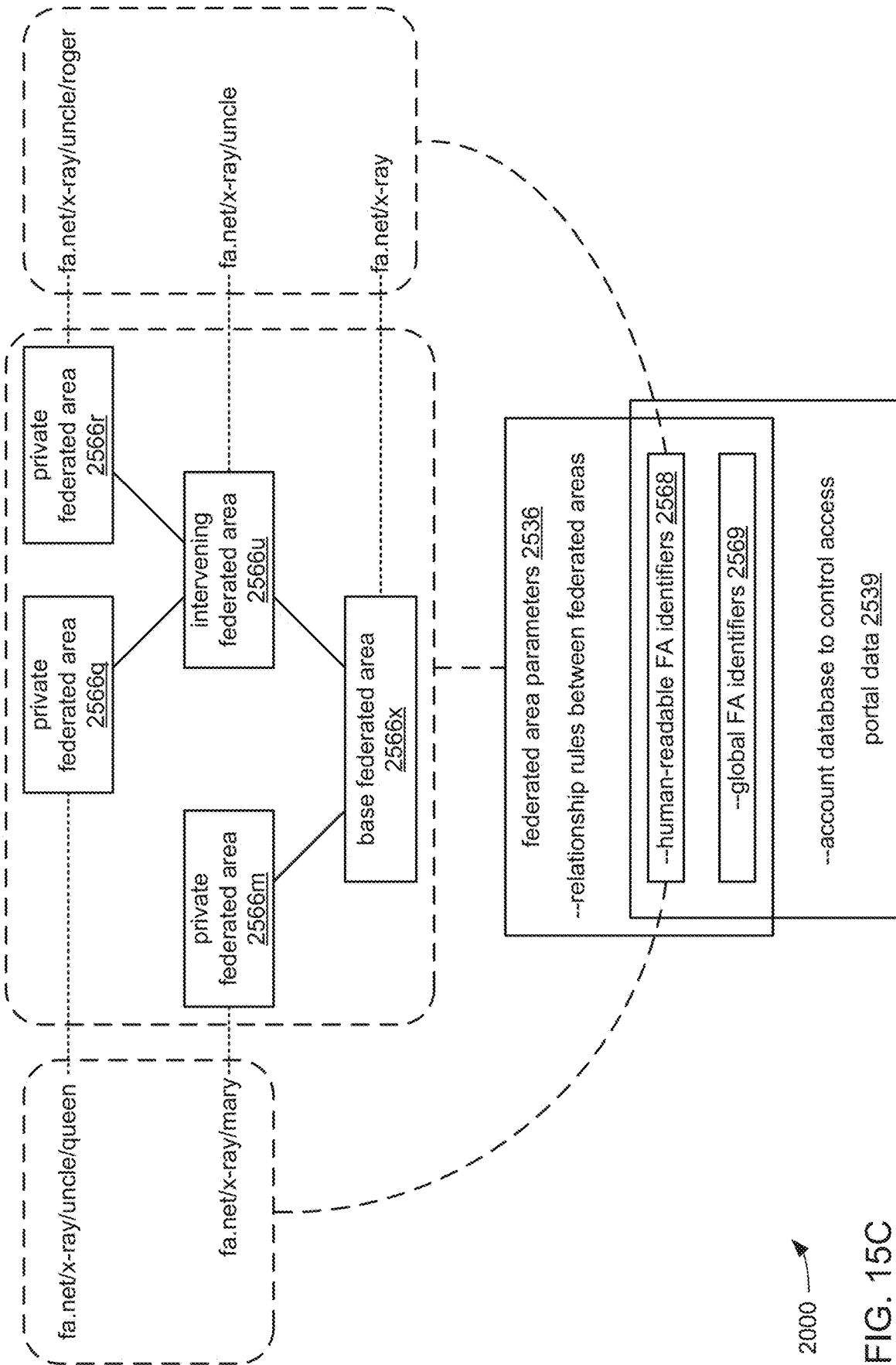

FIG. 15C

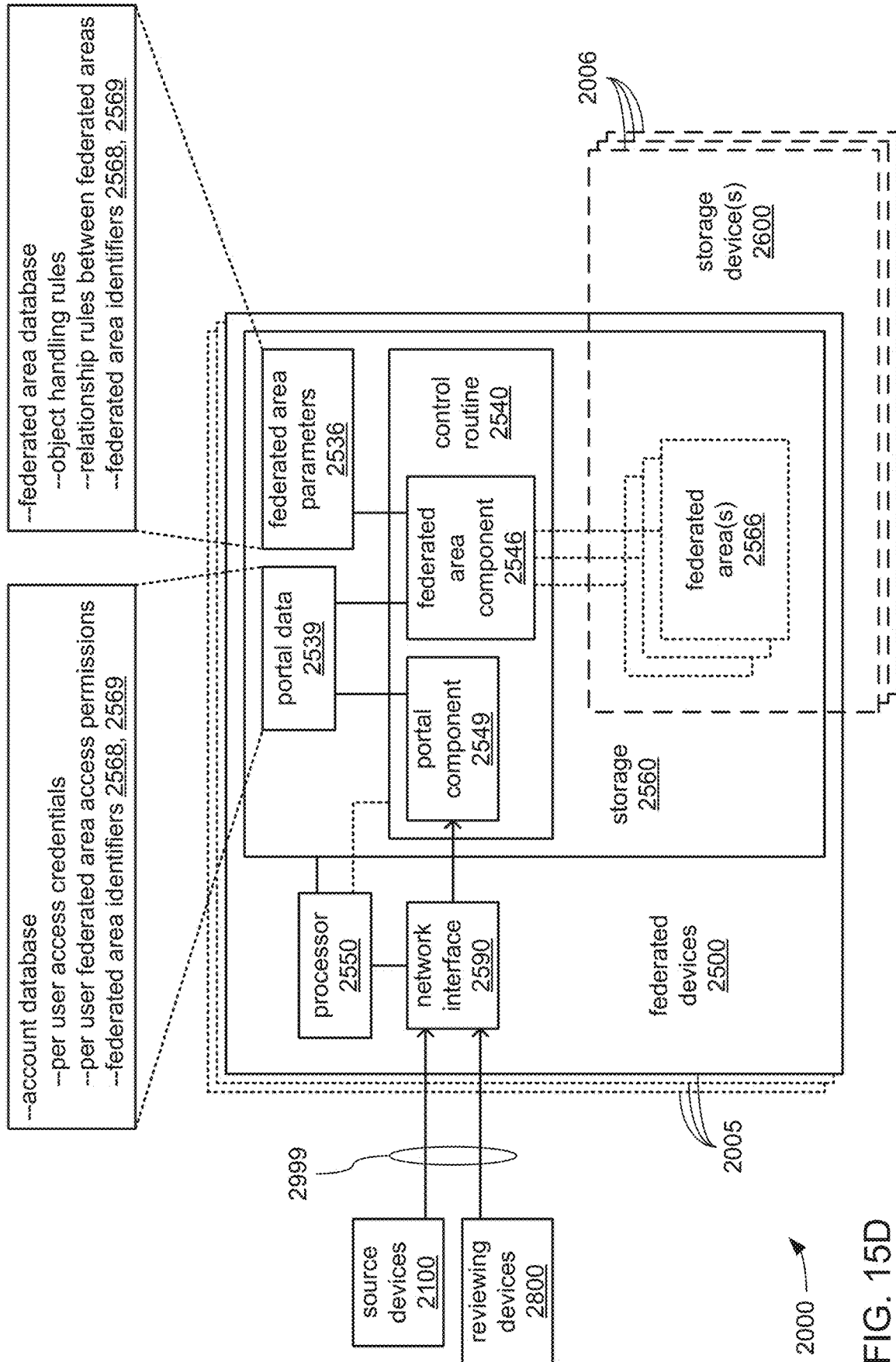
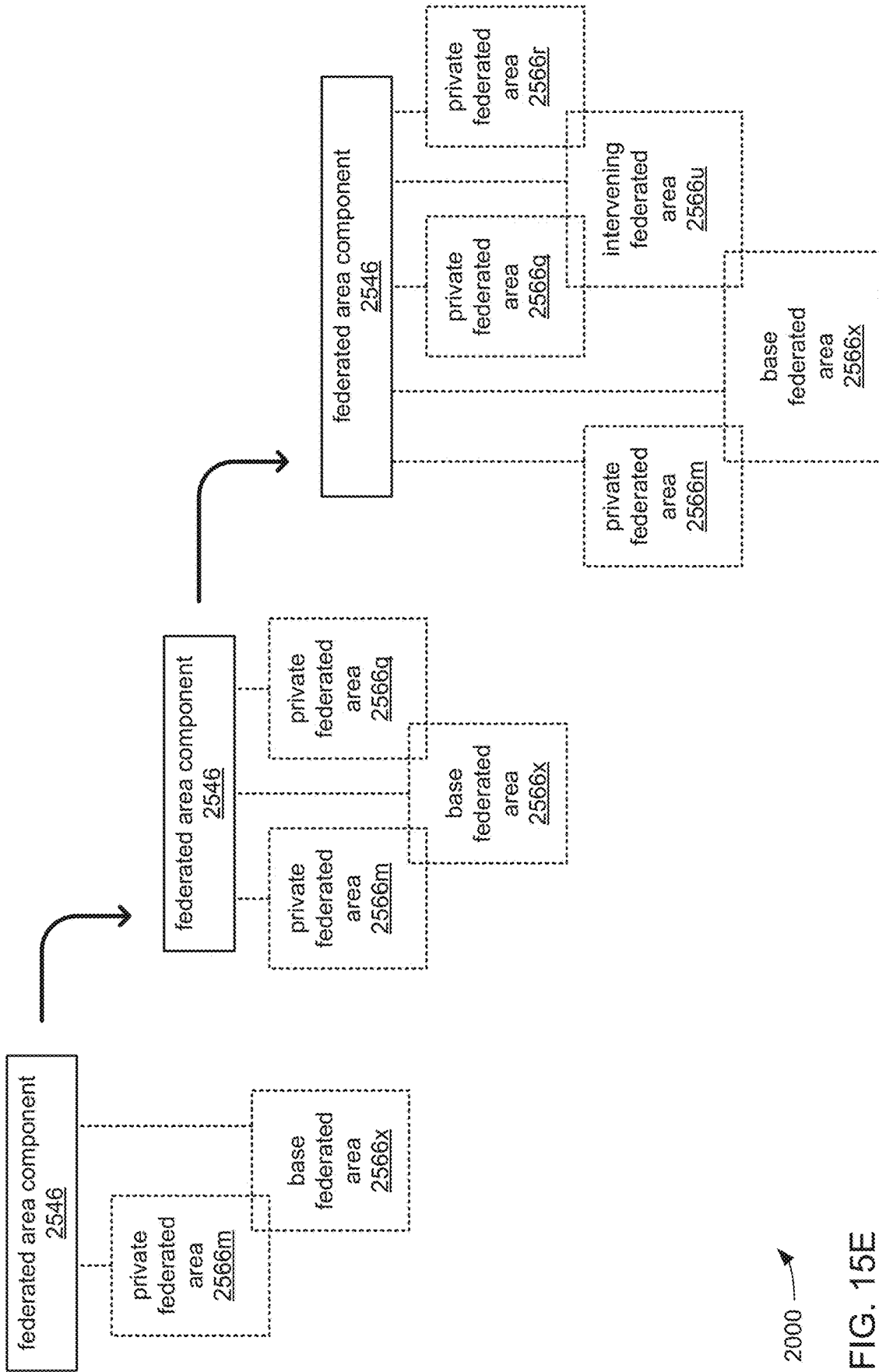

FIG. 15D



2000 →

FIG. 15E

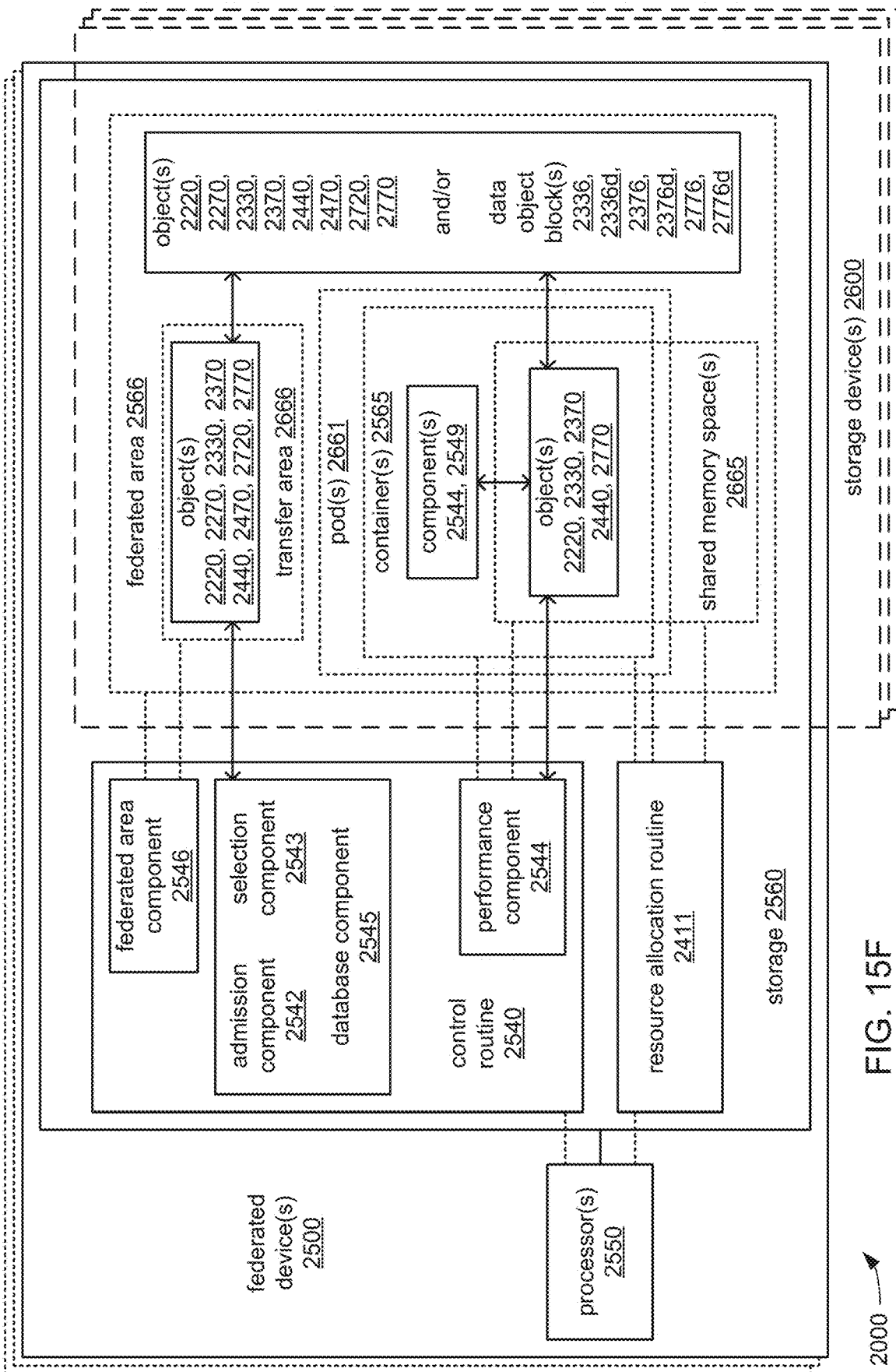

FIG. 15F

2000 →

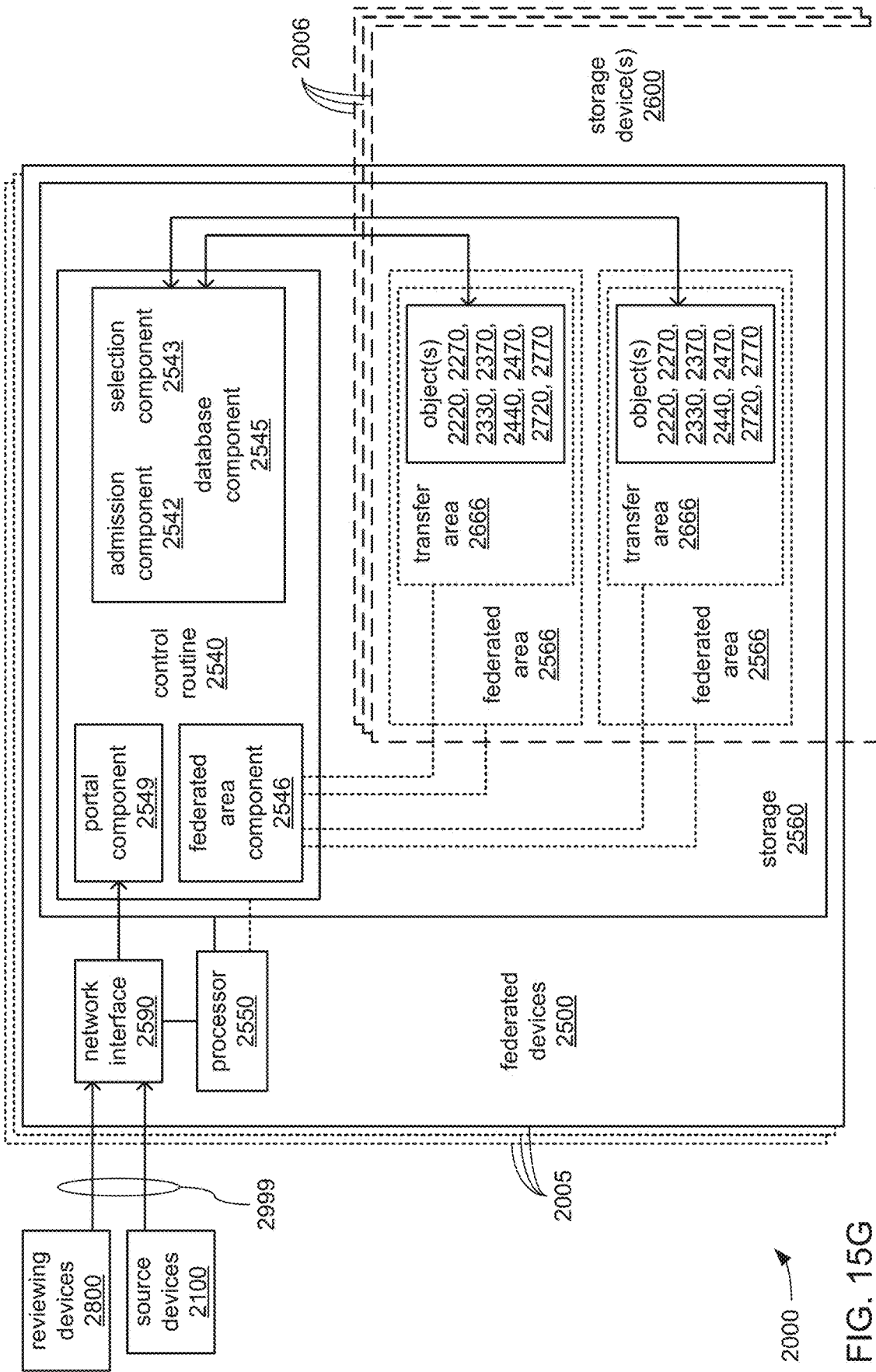

FIG. 15G

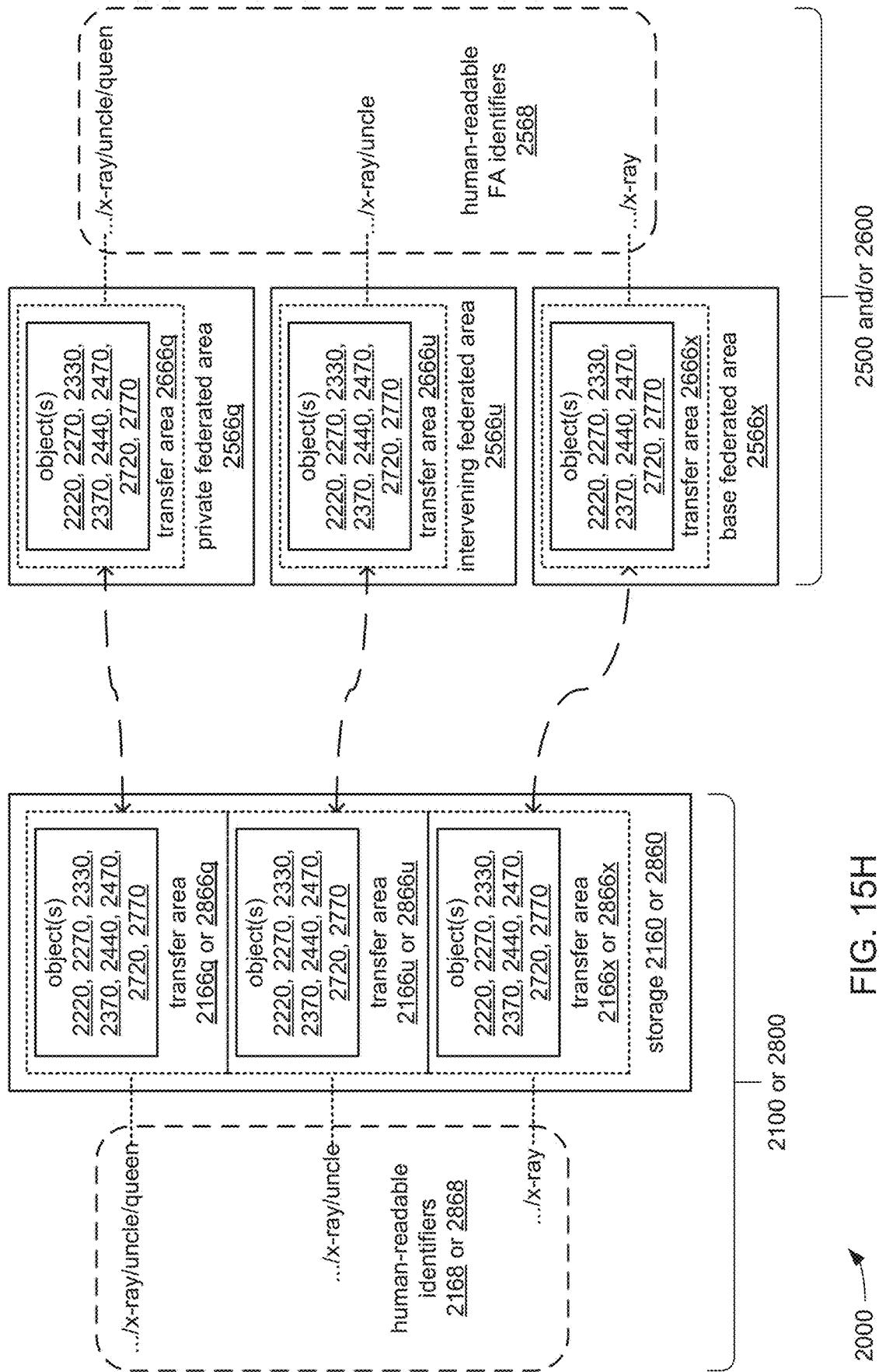

FIG. 15H

2000 →

FIG. 15I

2000

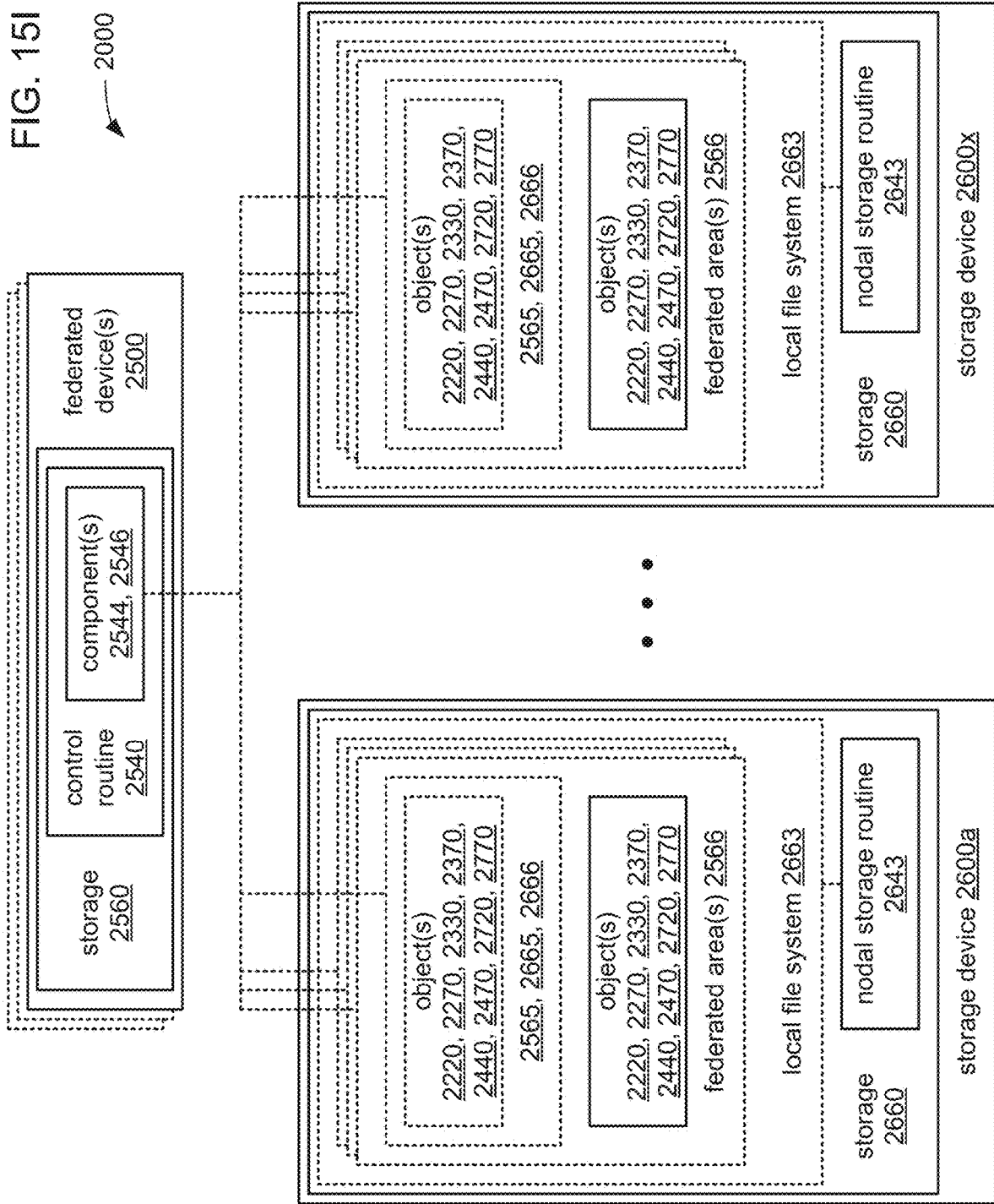
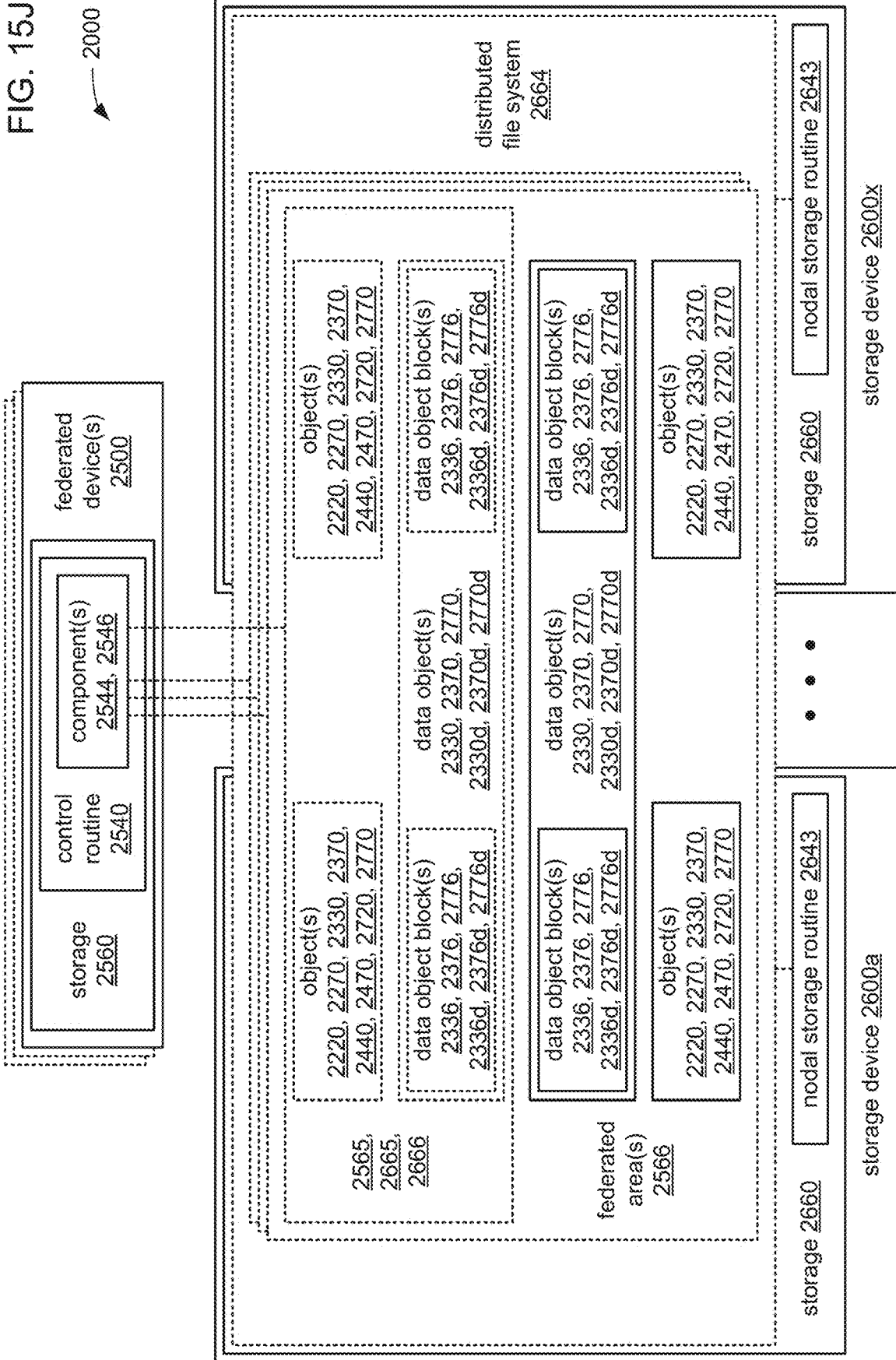

FIG. 15J



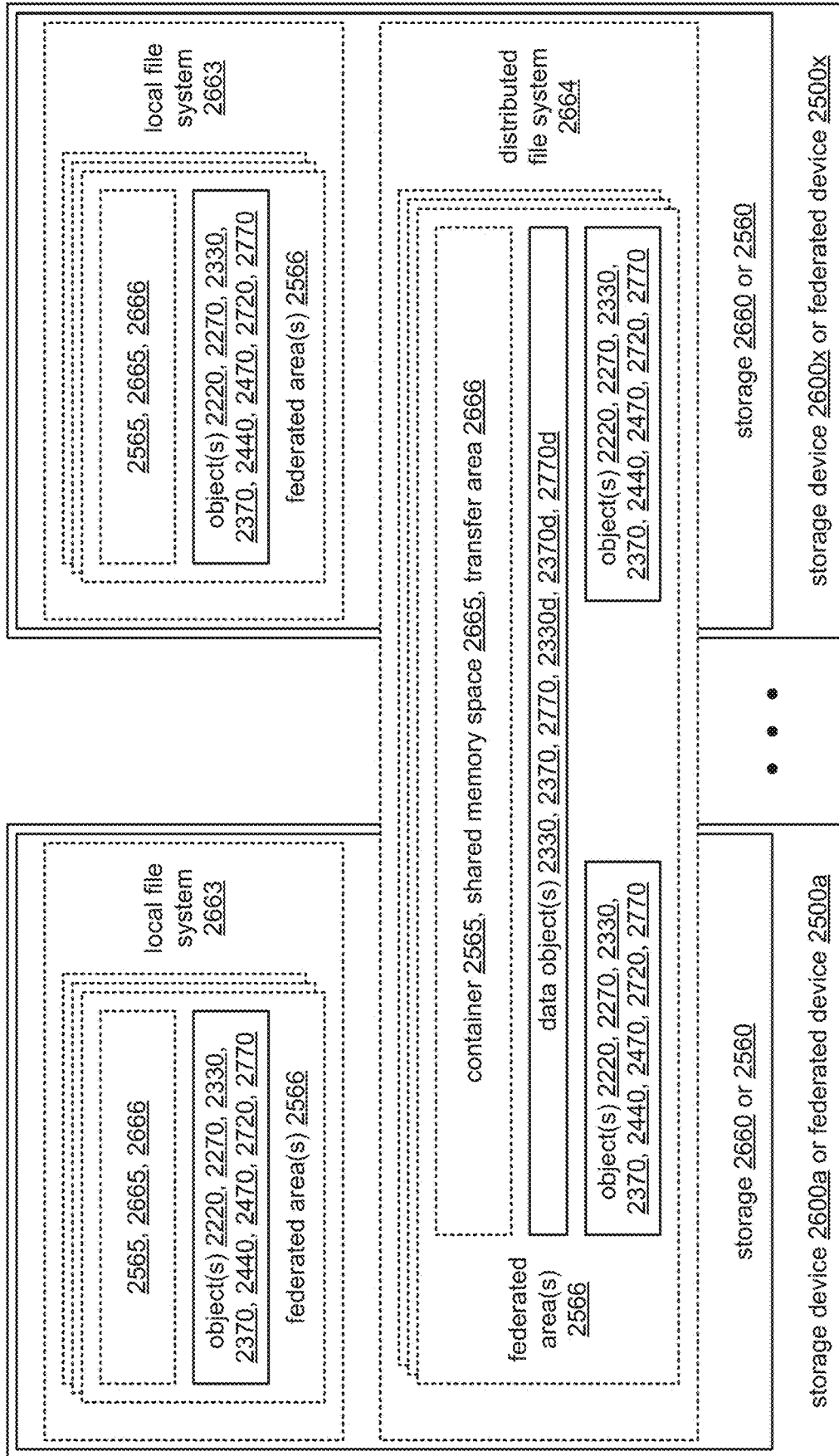
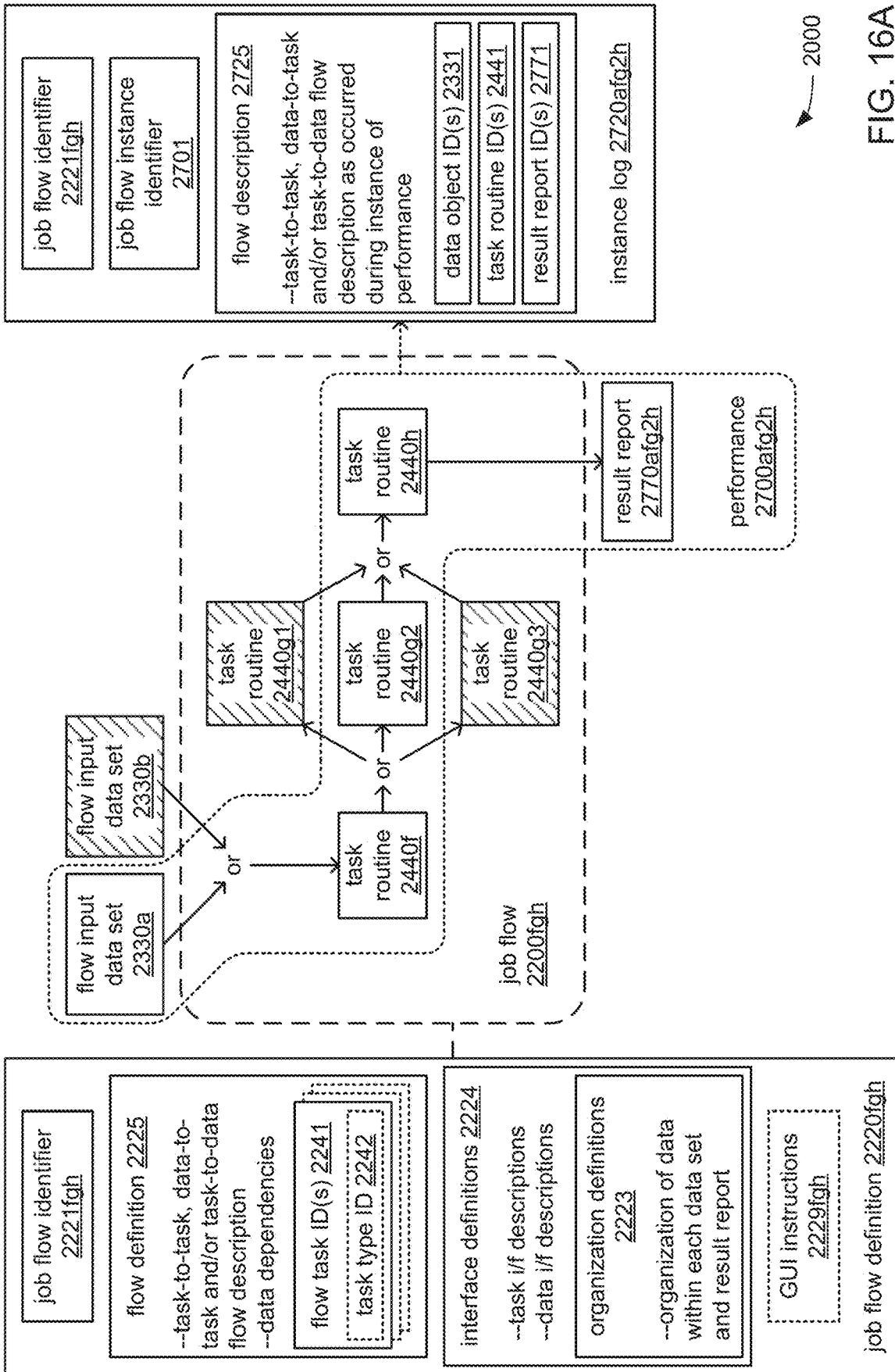

FIG. 15K

2000 →



2000

FIG. 16A

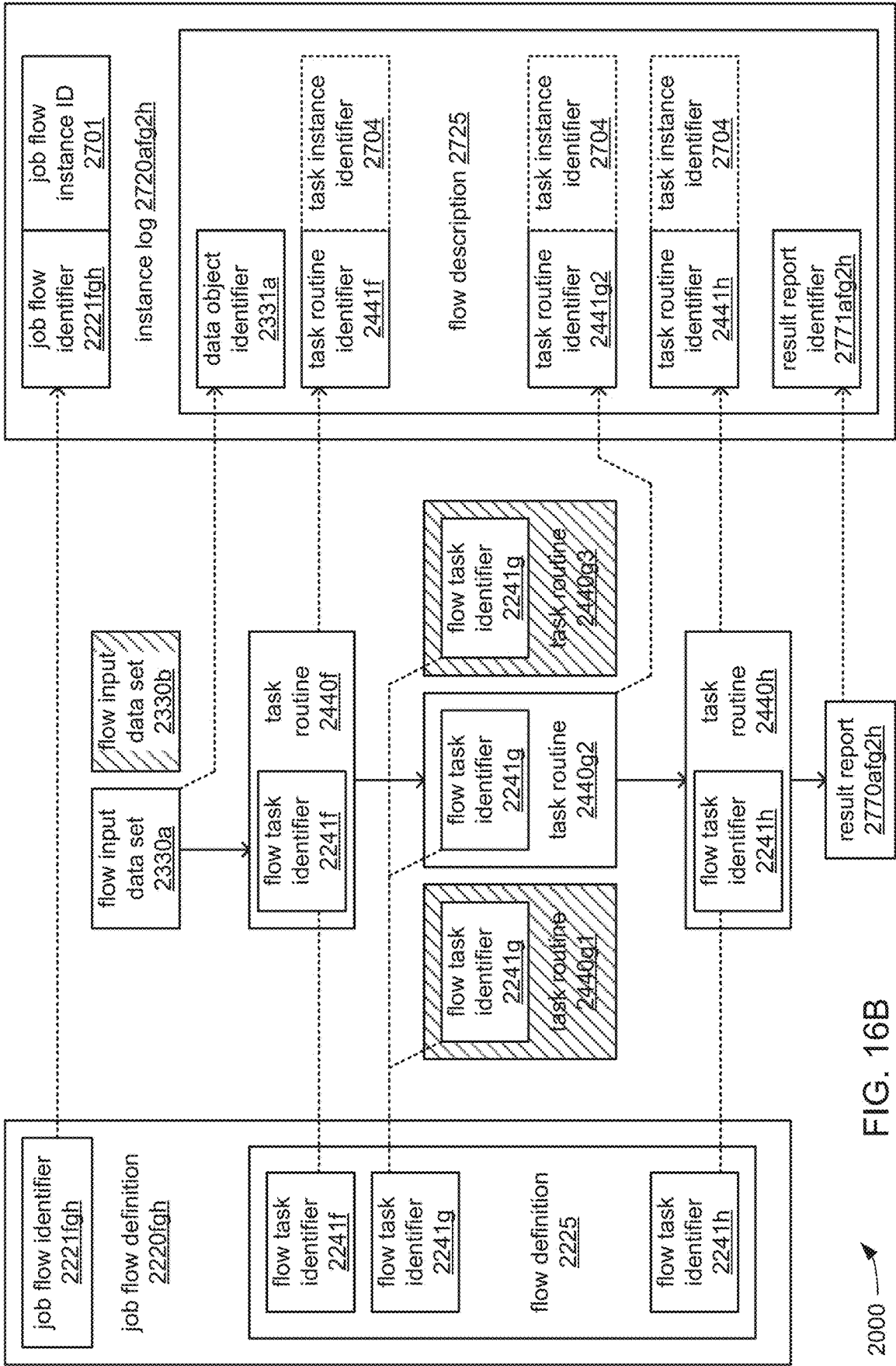

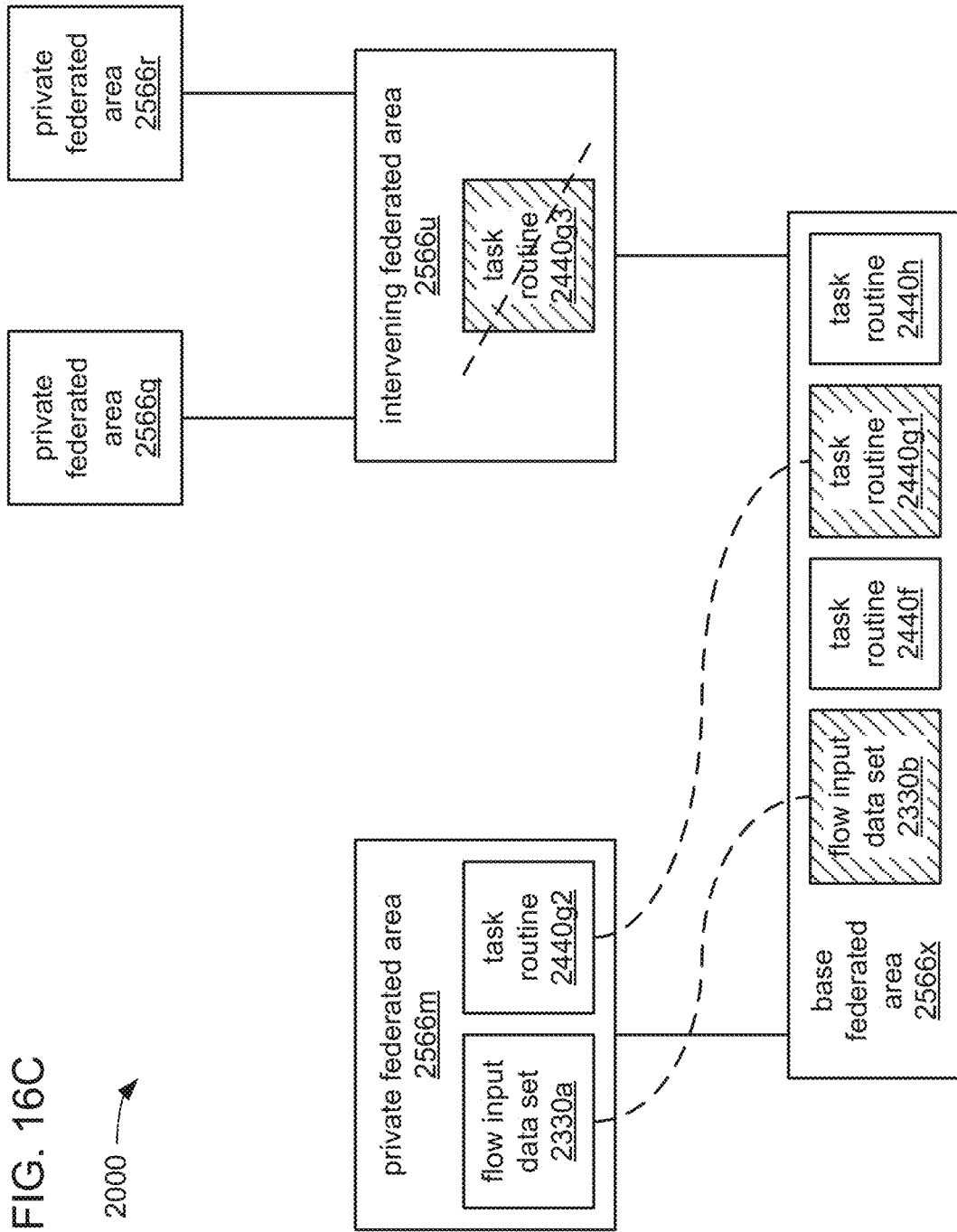

FIG. 16B

2000 →

FIG. 16C

2000 



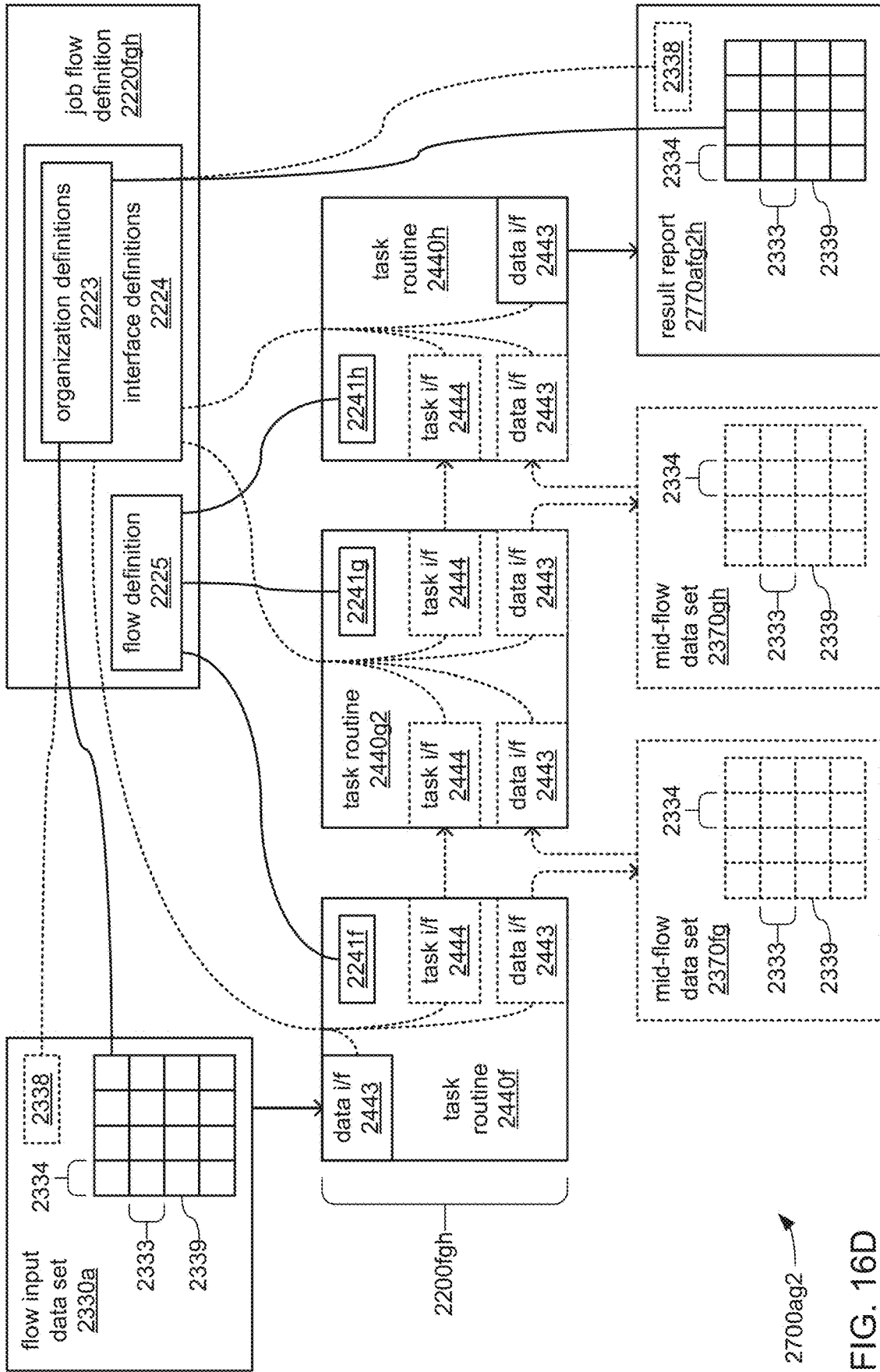

FIG. 16D

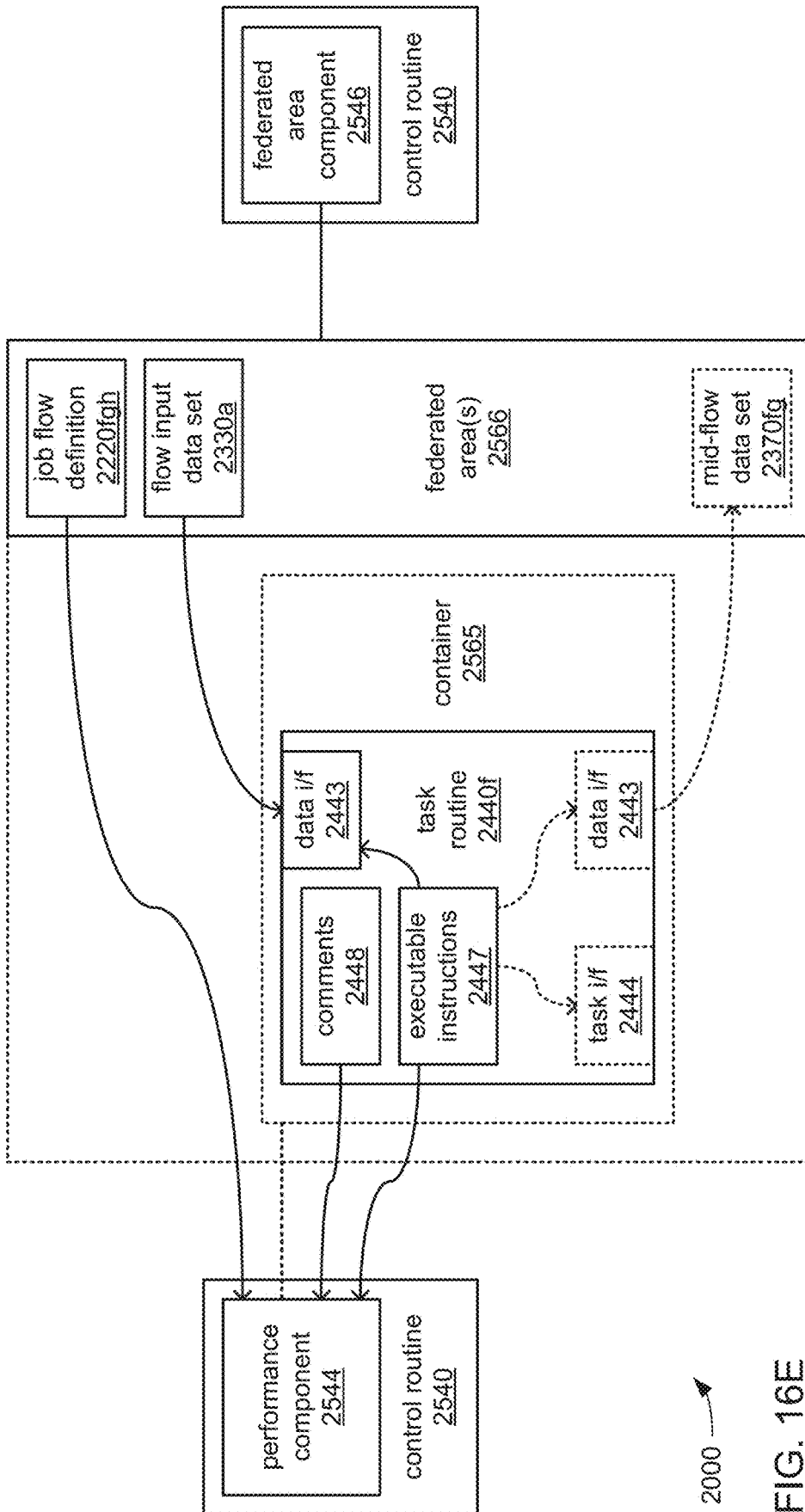

FIG. 16E

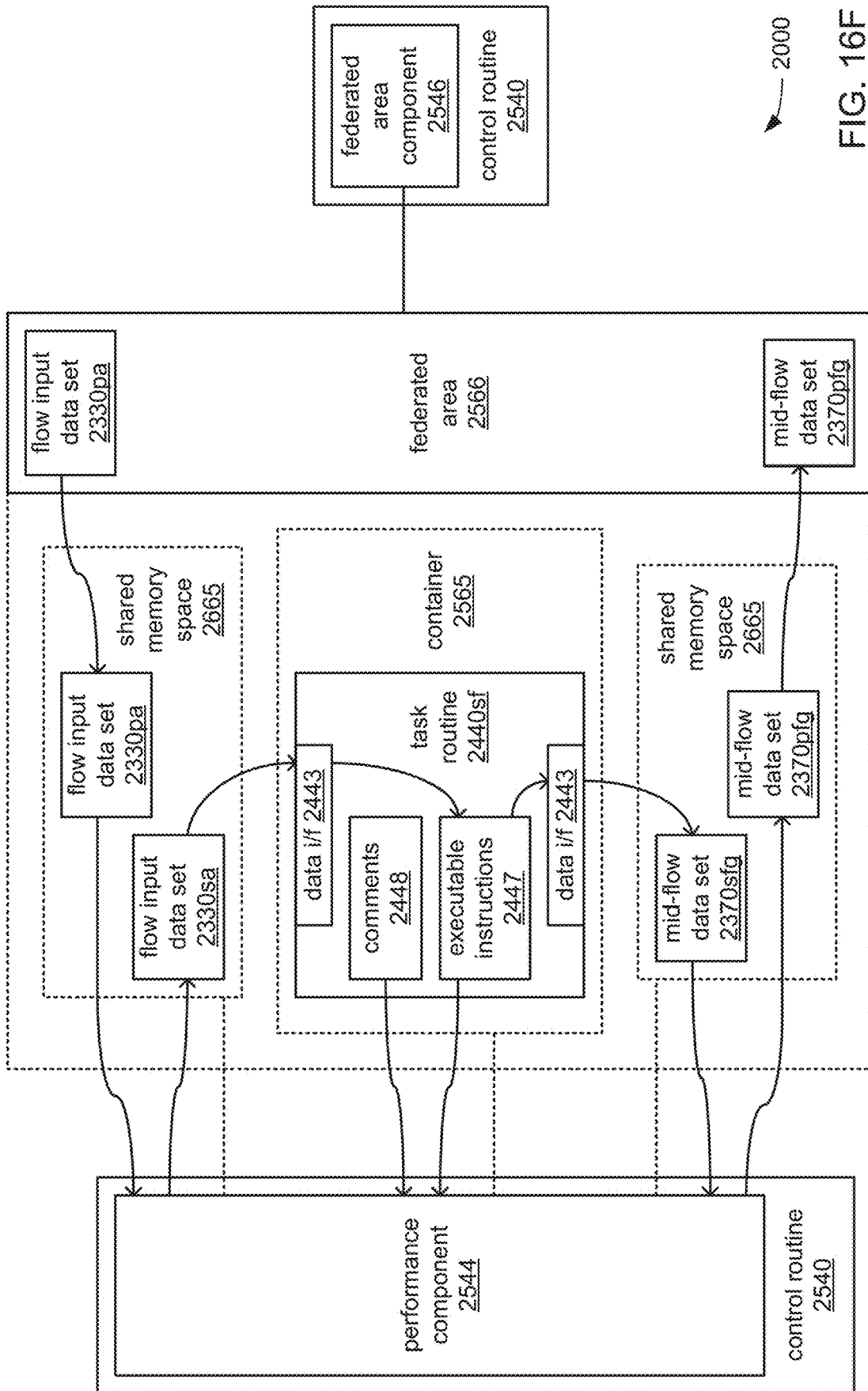

FIG. 16F

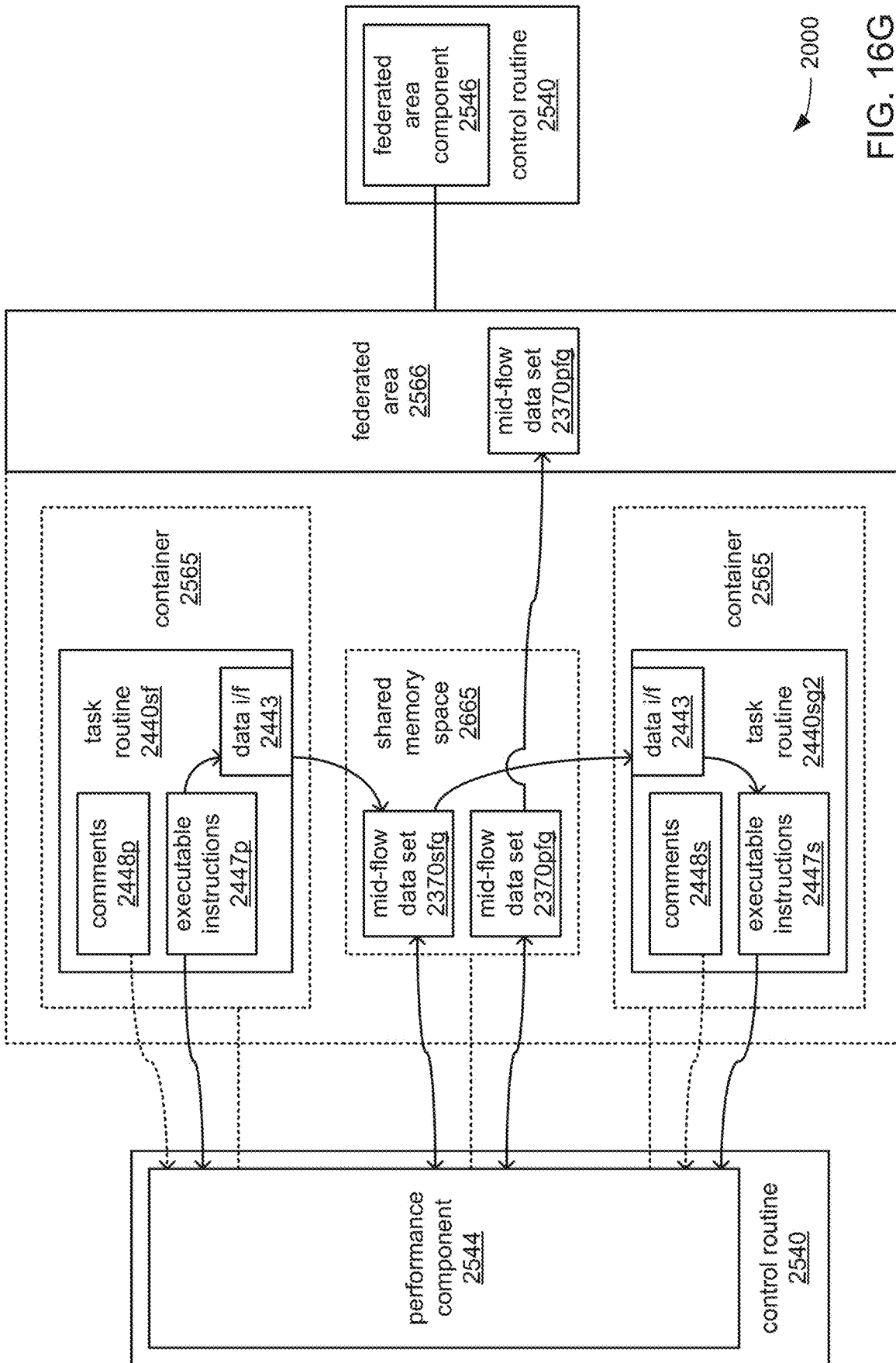
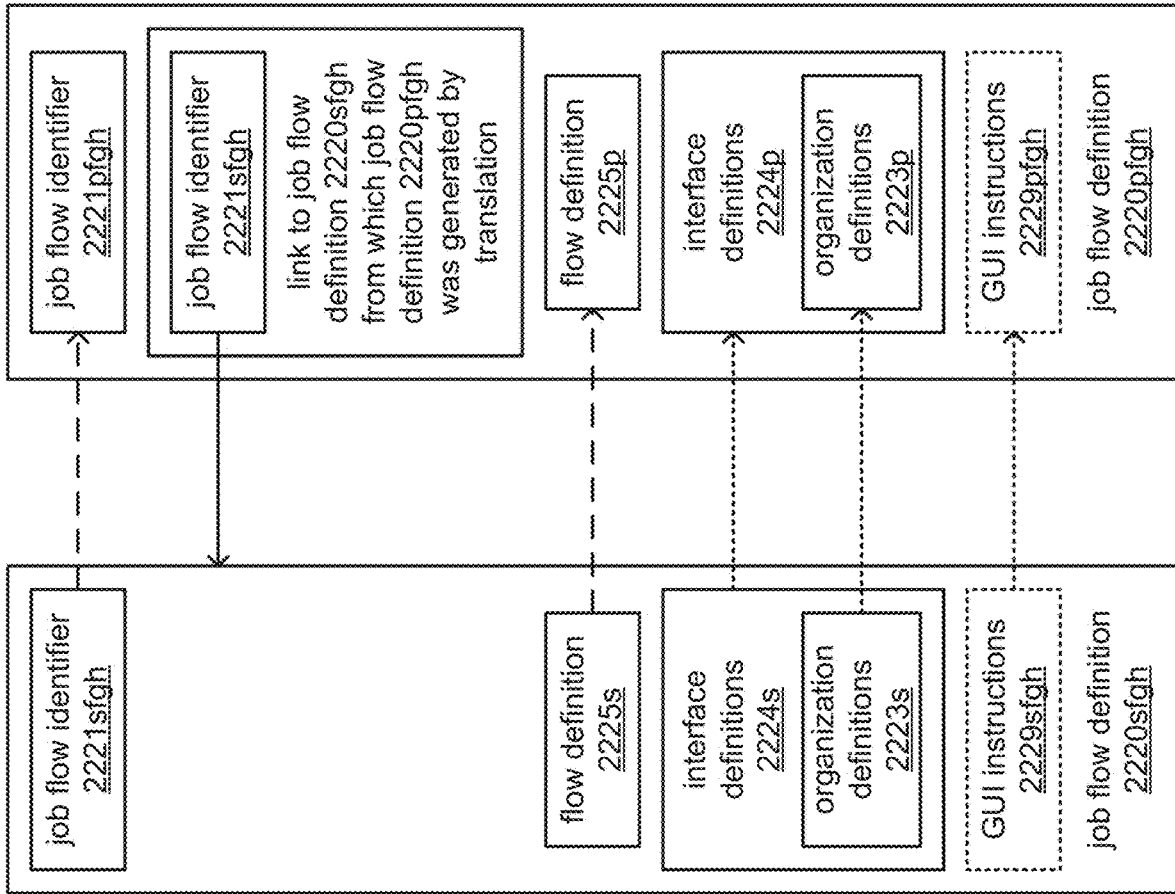

FIG. 16G



2000 →

FIG. 16H

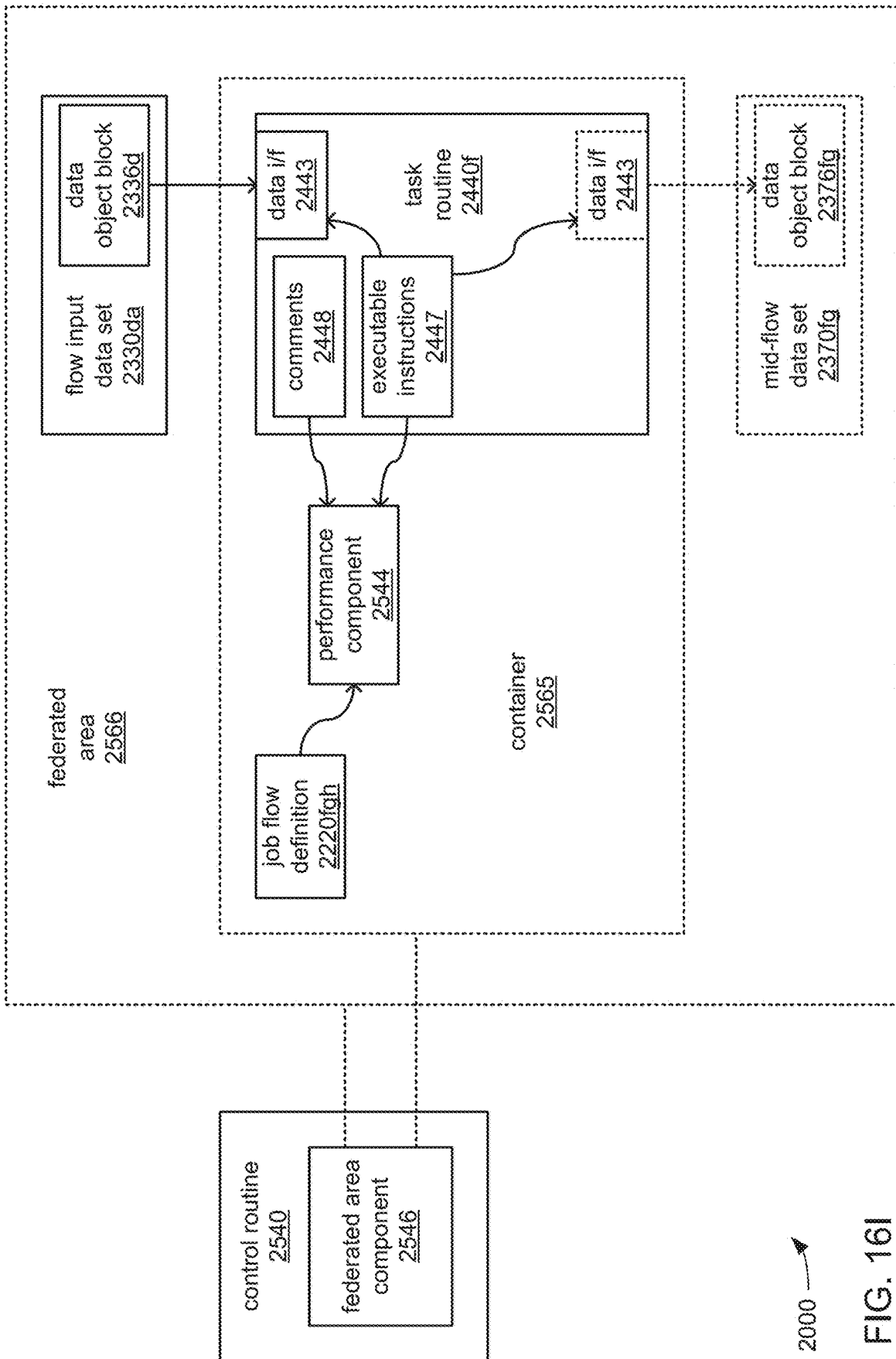

FIG. 16I

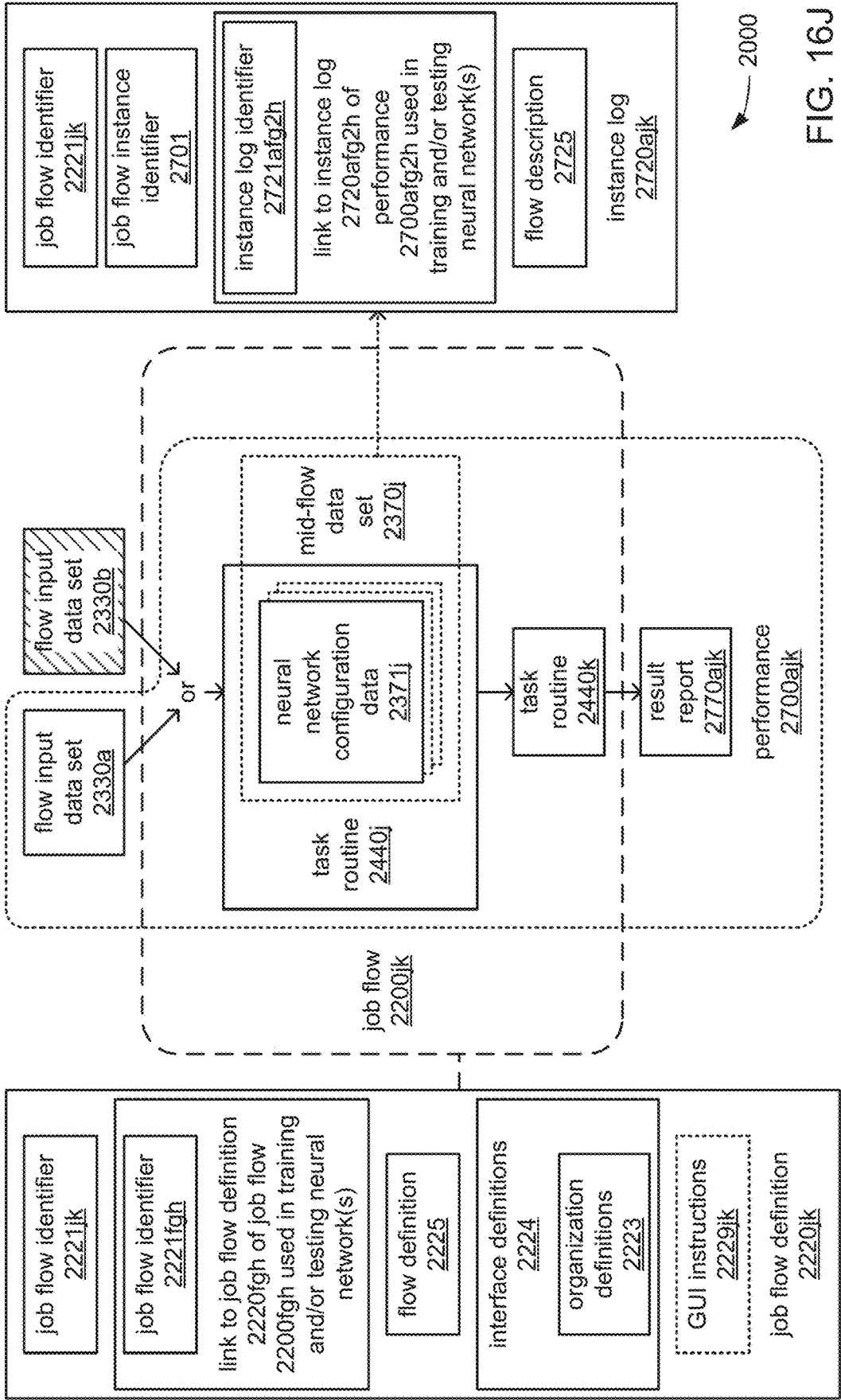
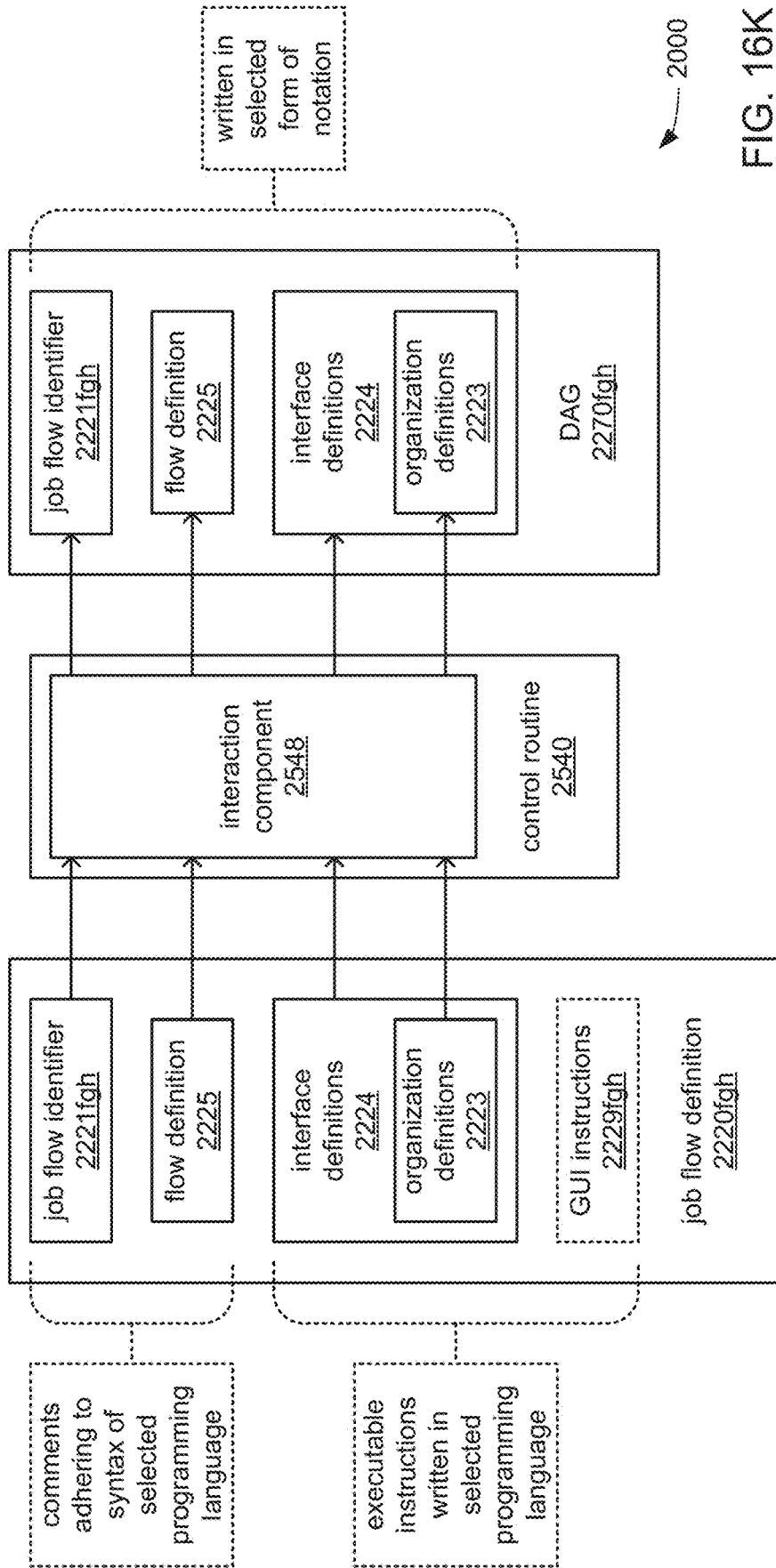
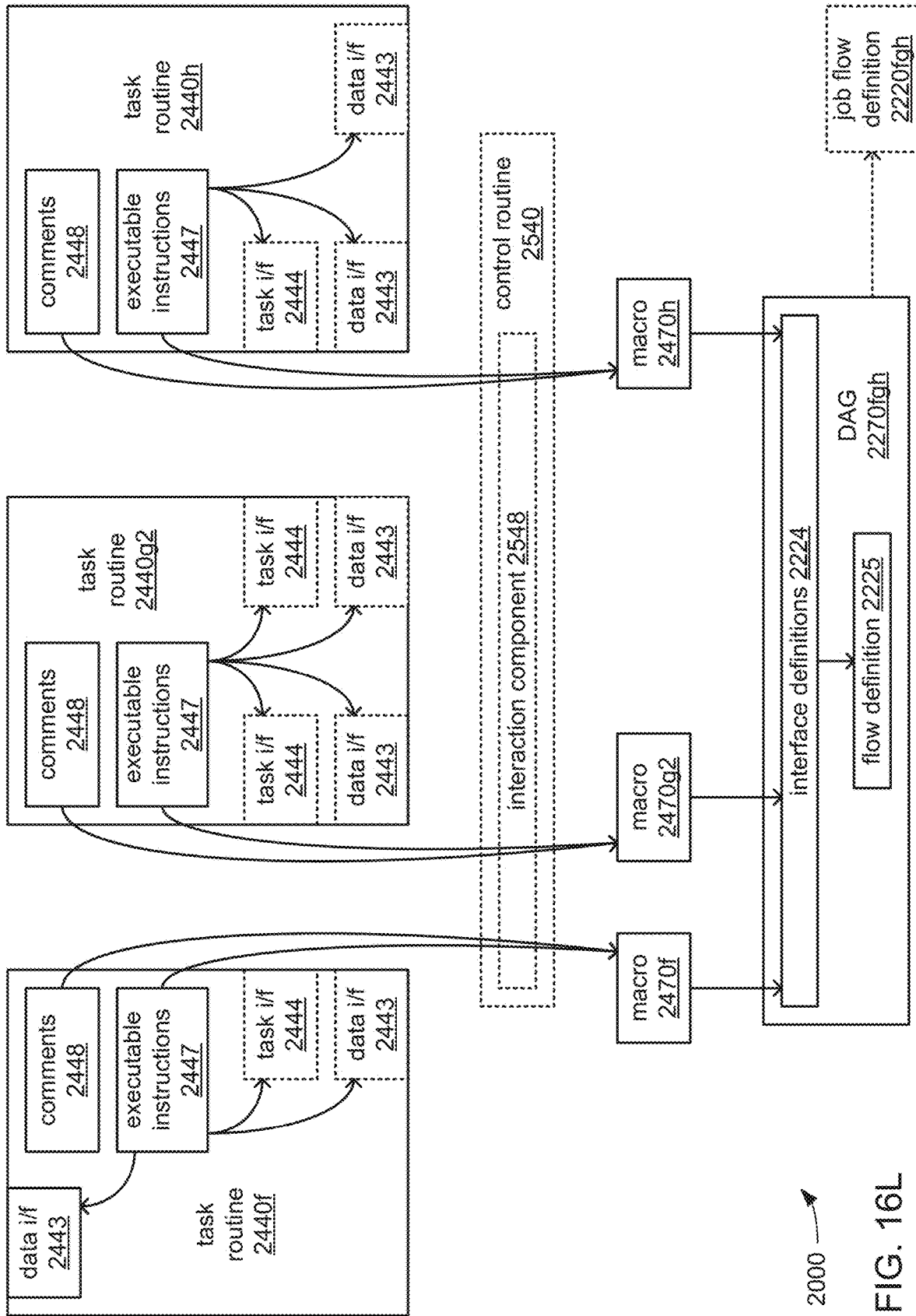

FIG. 16J



2000

FIG. 16K



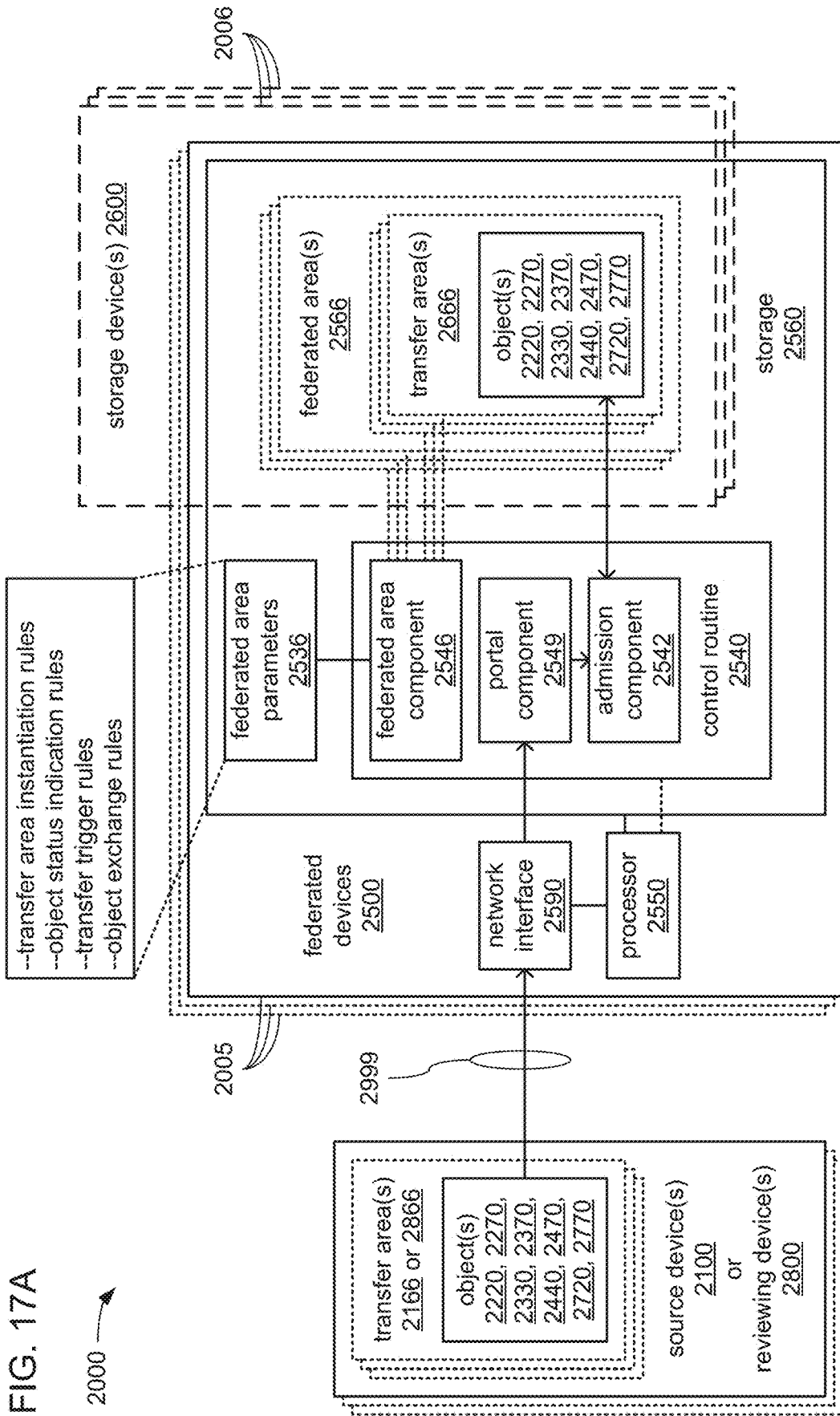
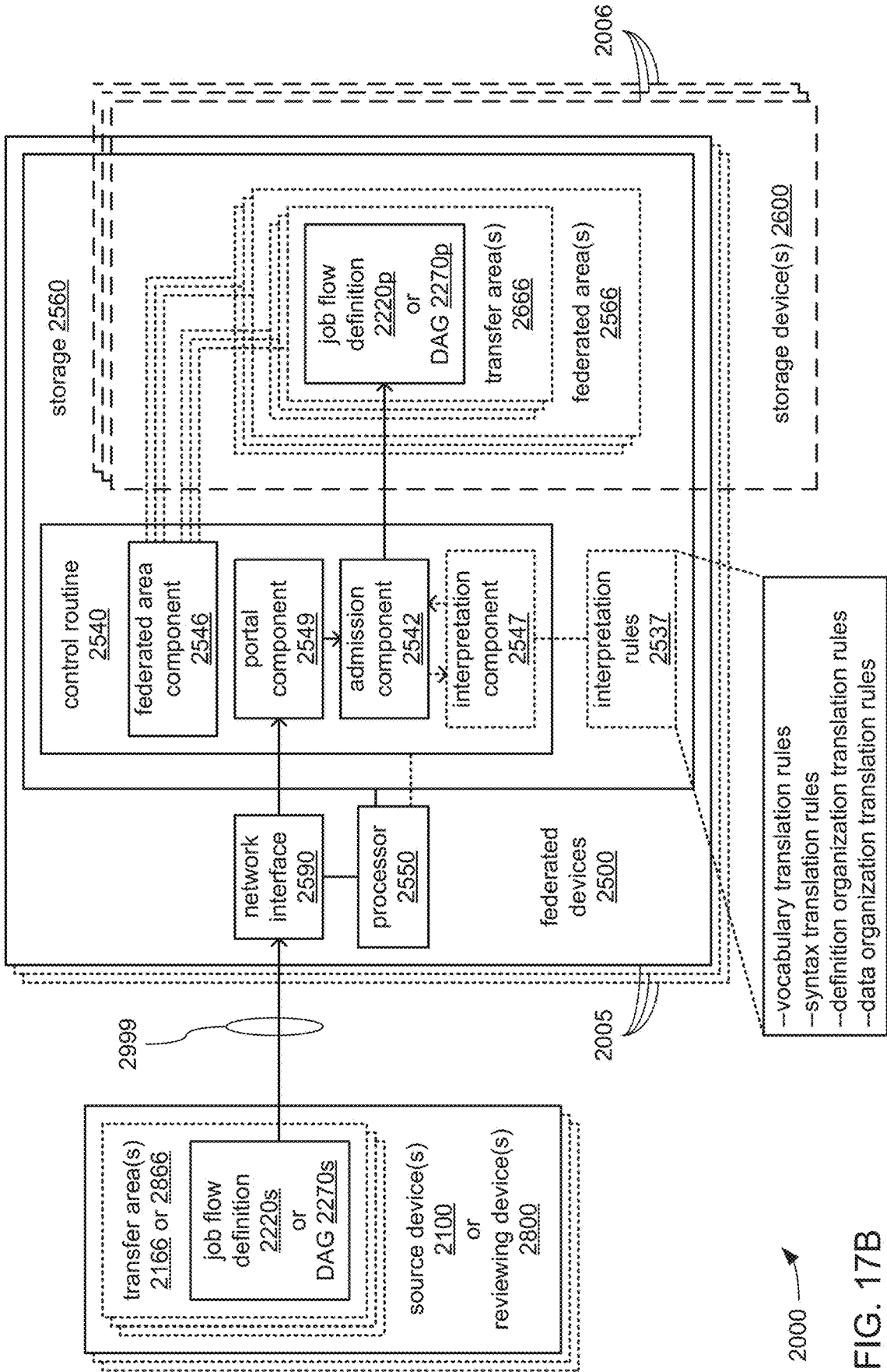

FIG. 17A



2000 →
FIG. 17B

- vocabulary translation rules
- syntax translation rules
- definition organization translation rules
- data organization translation rules

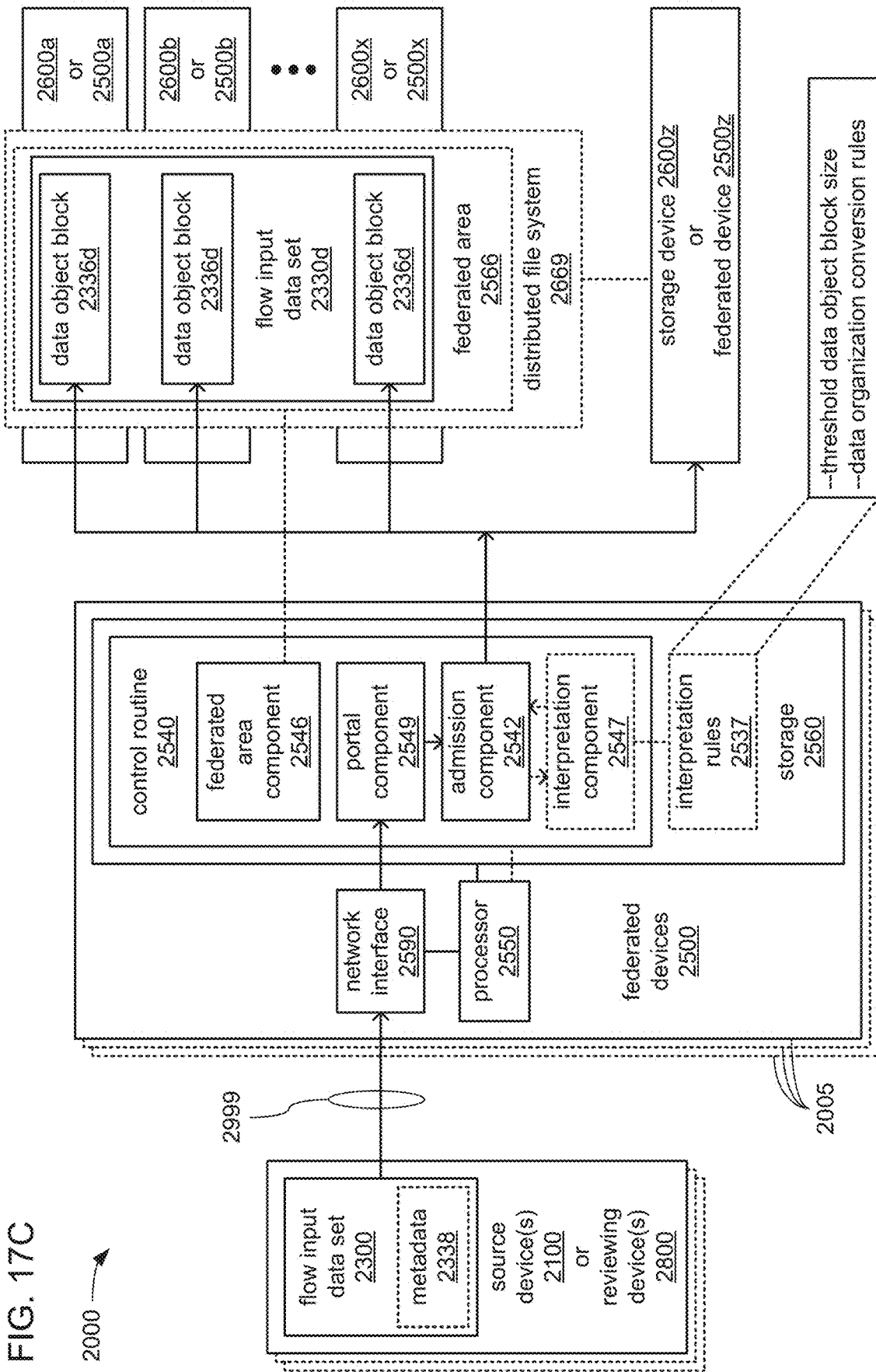

FIG. 17C

2000

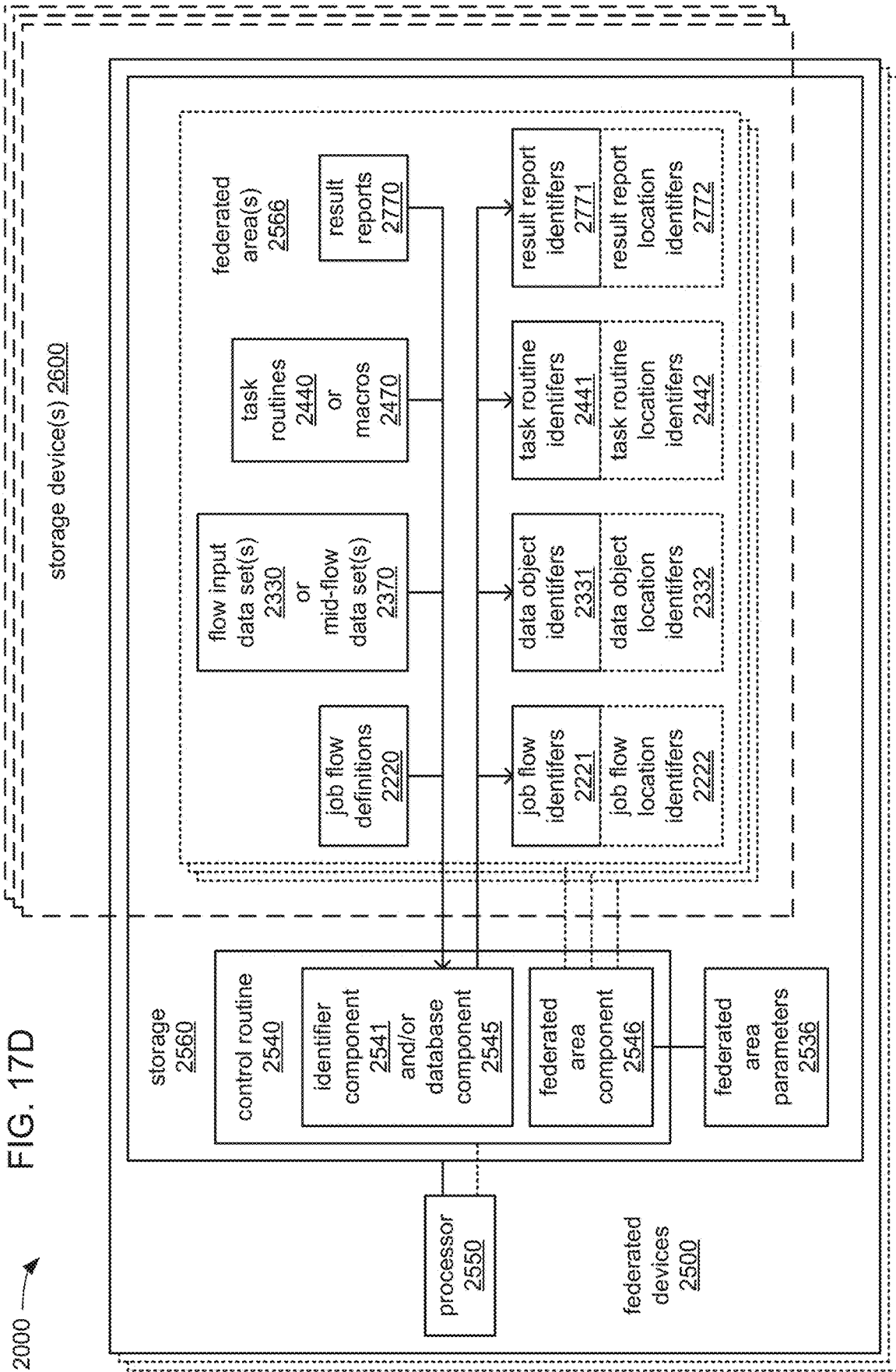

FIG. 17D

2000

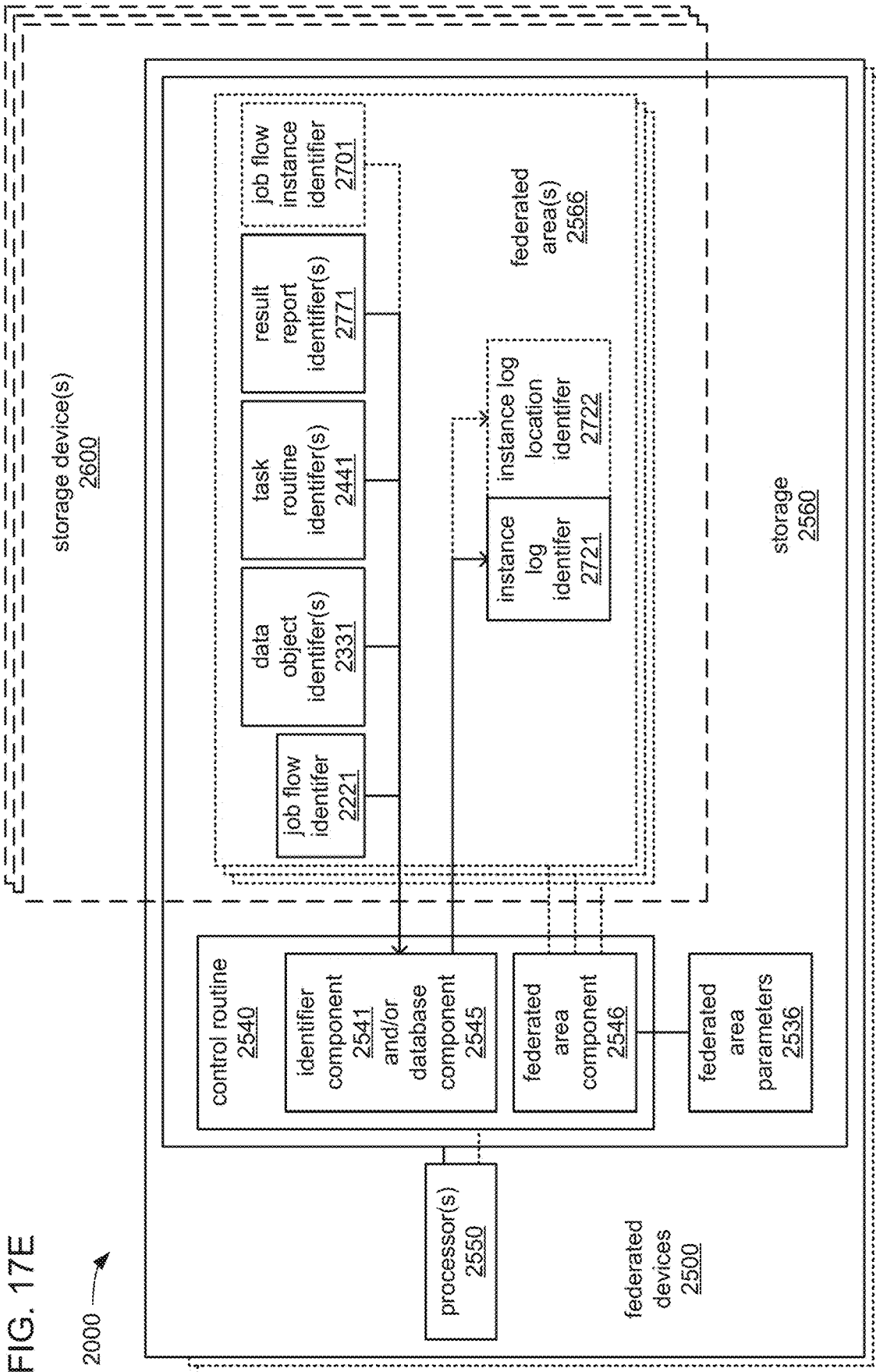

FIG. 17E

2000 →

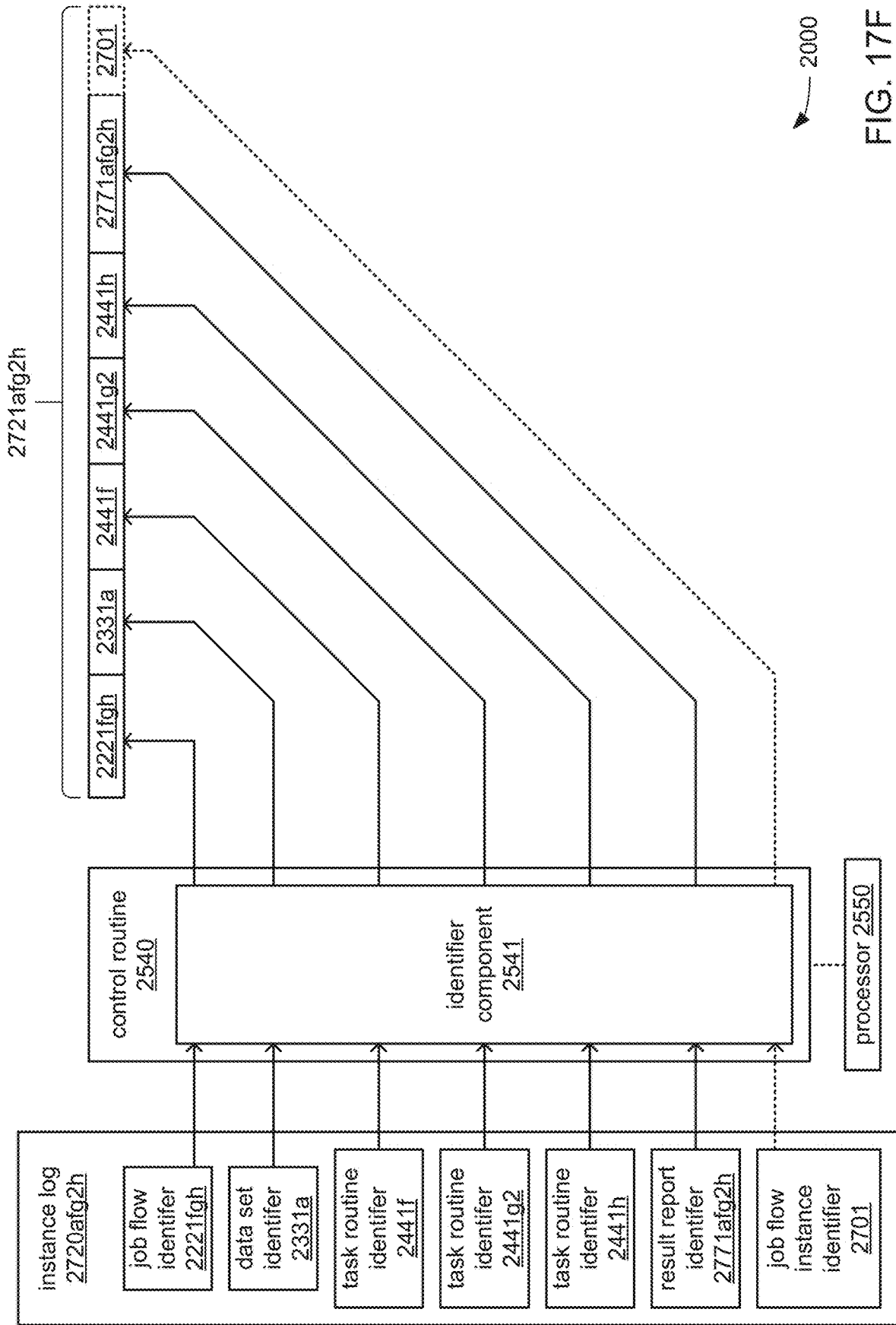

FIG. 17F

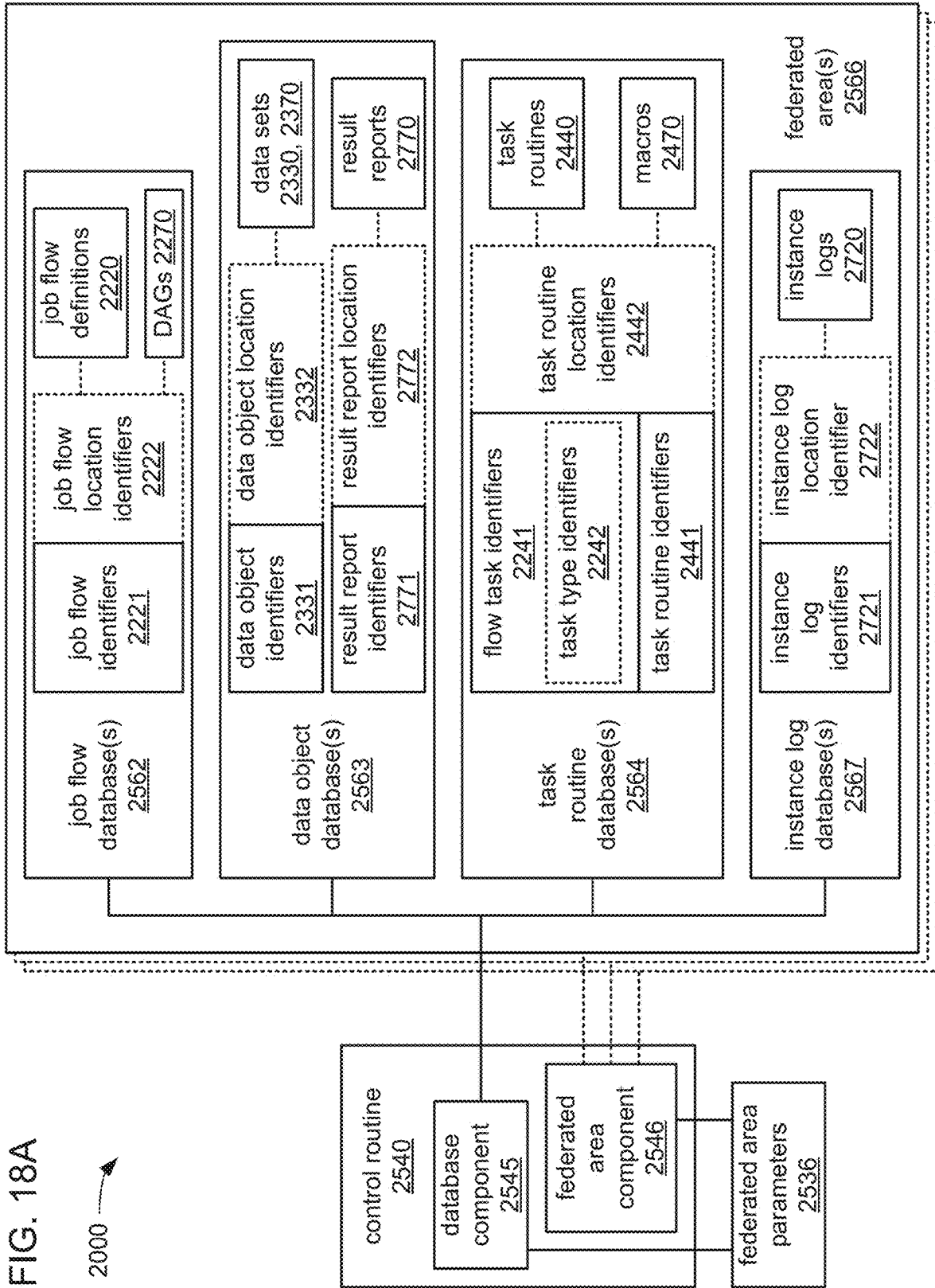

FIG. 18B

2000 →

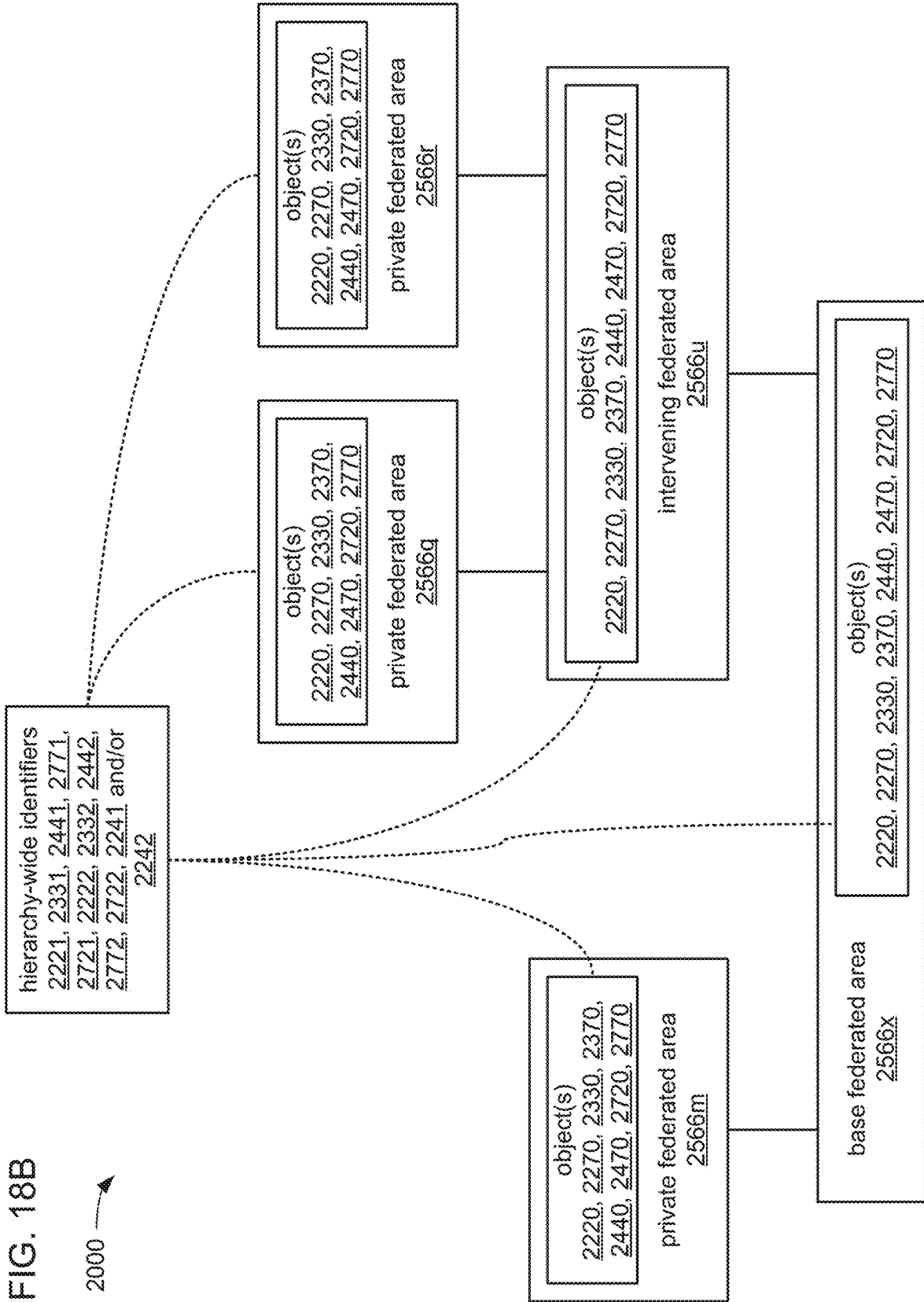
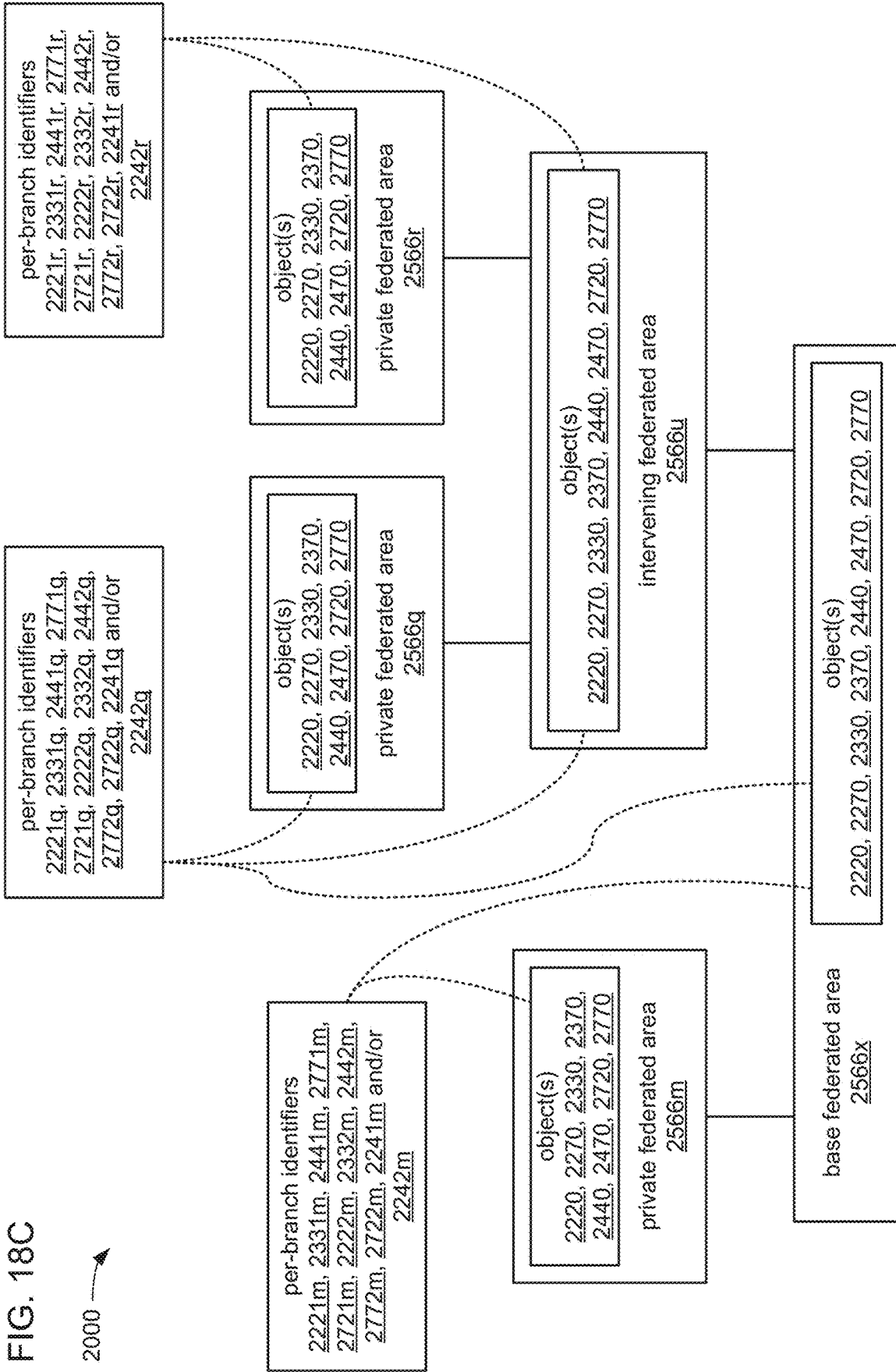
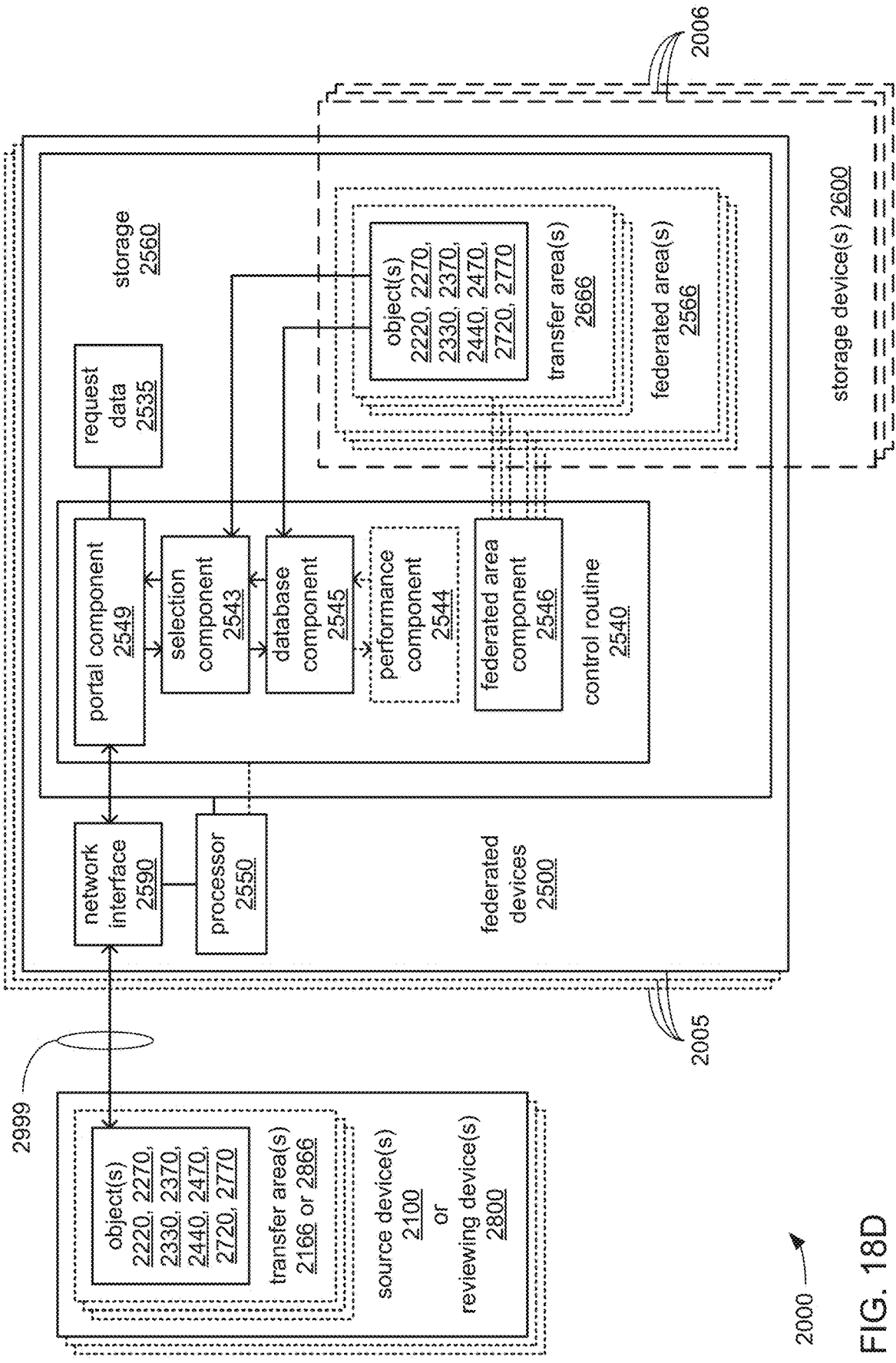

FIG. 18C

2000 ↗





2000 →
FIG. 18D

FIG. 18E

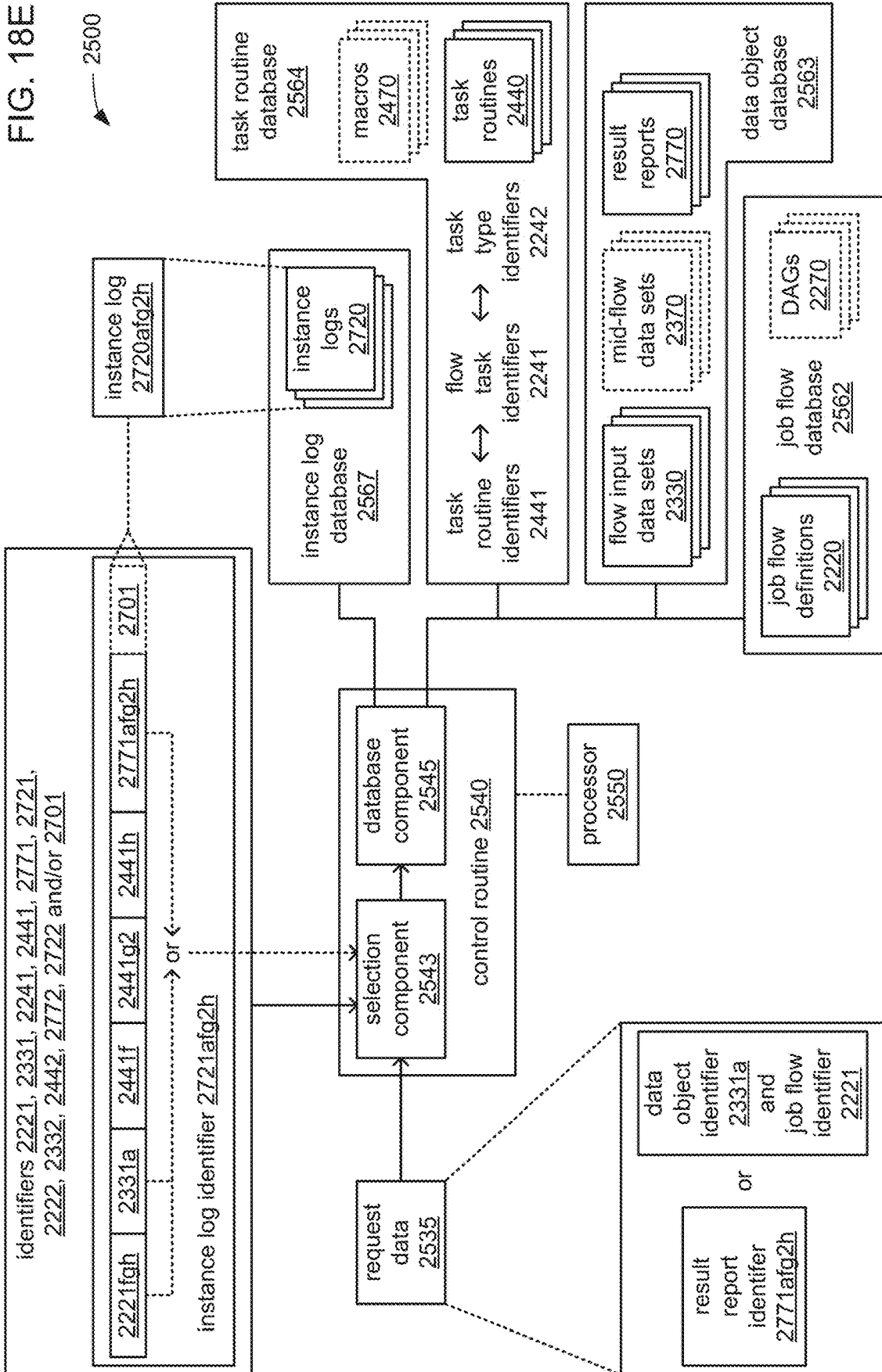

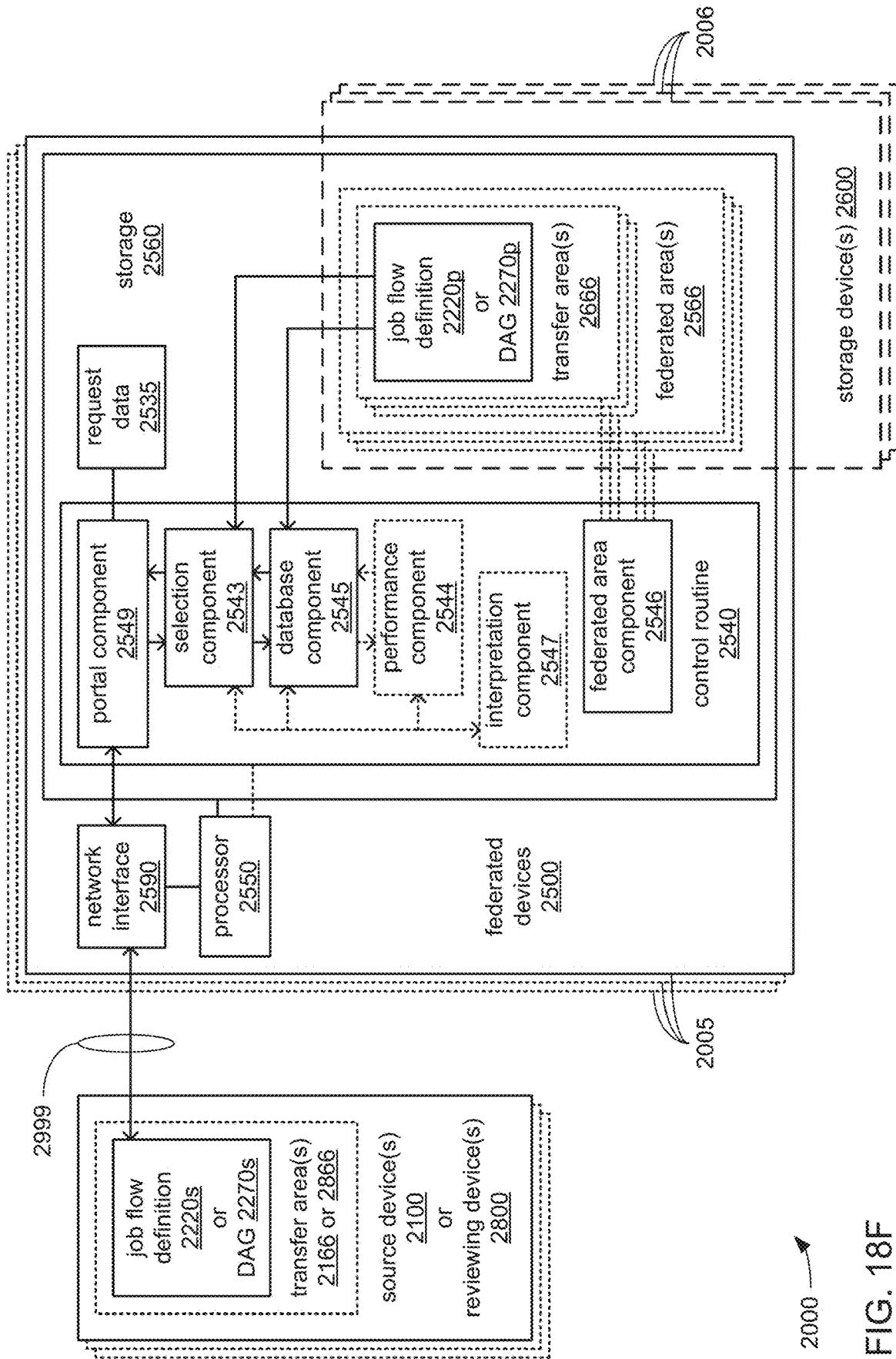

FIG. 18F

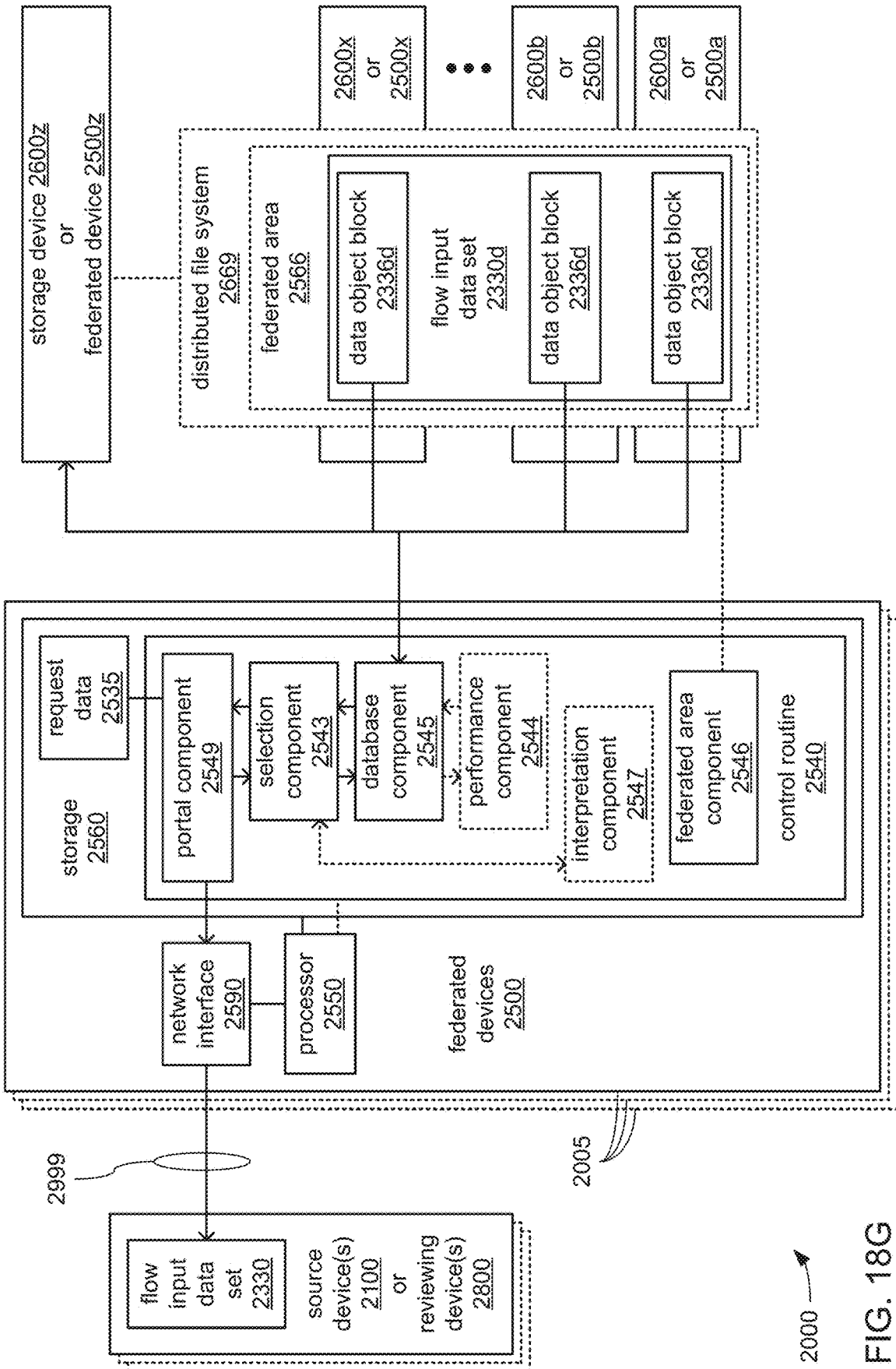

FIG. 18G

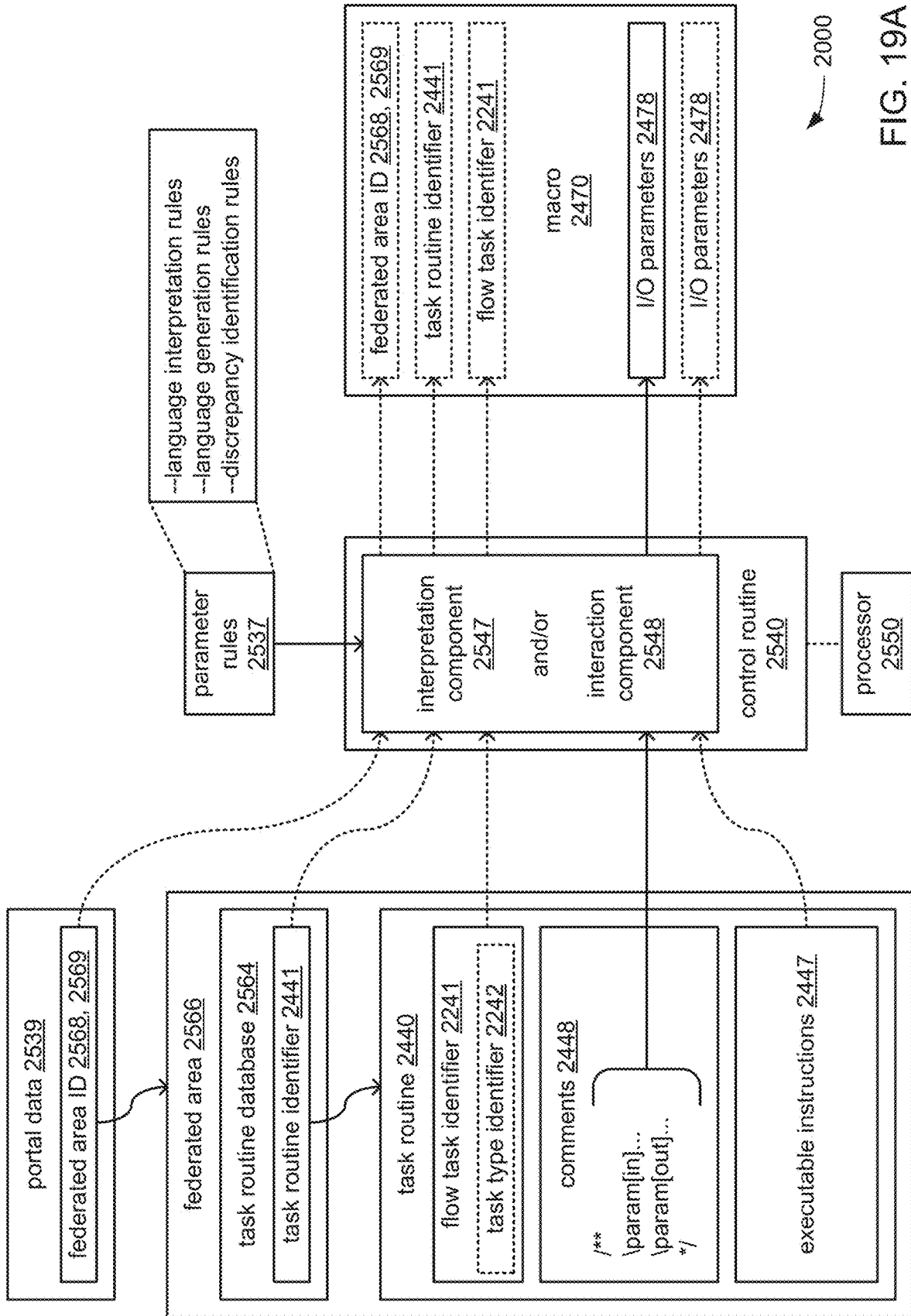
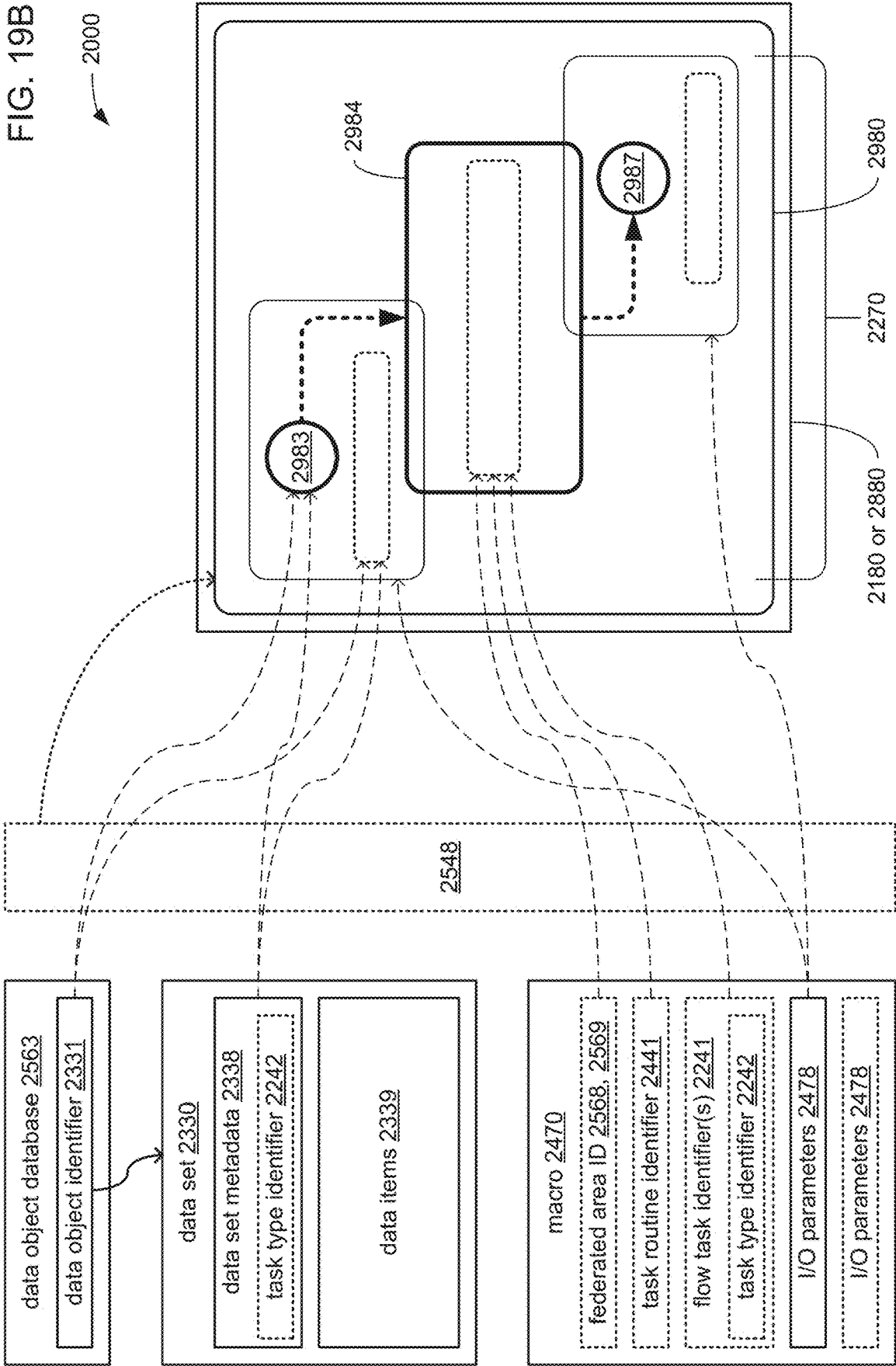
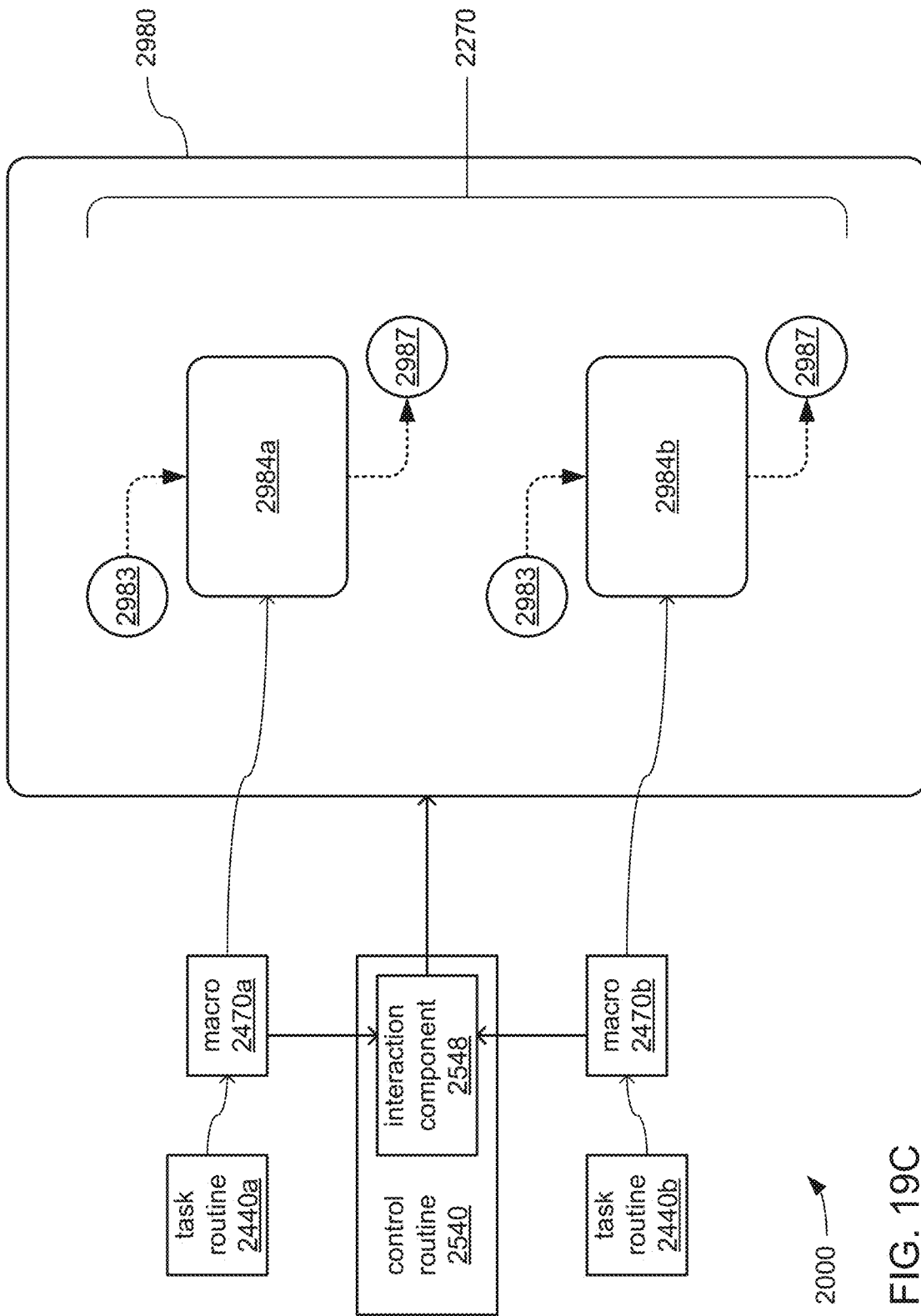

FIG. 19A

FIG. 19B





2000

FIG. 19C

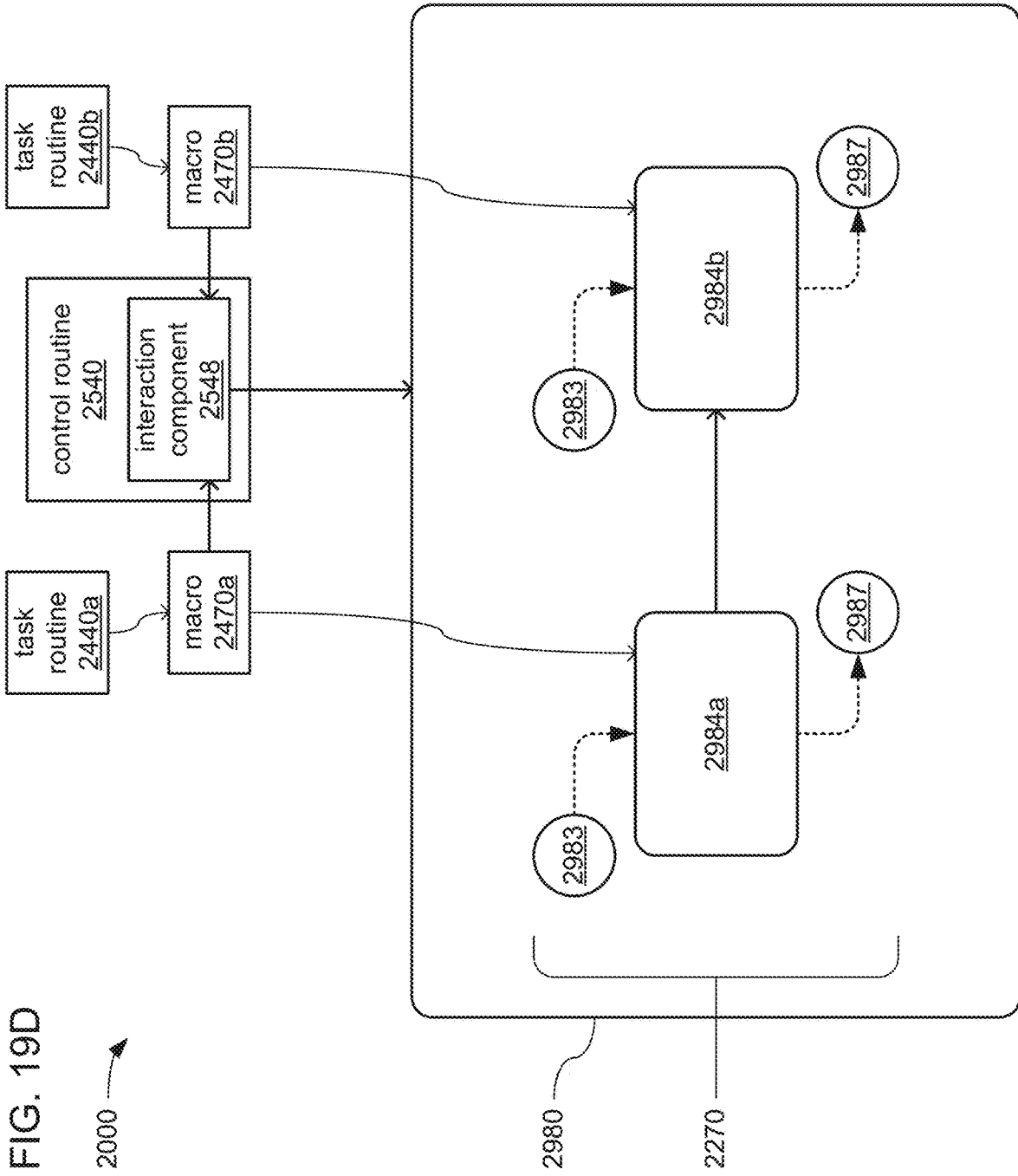
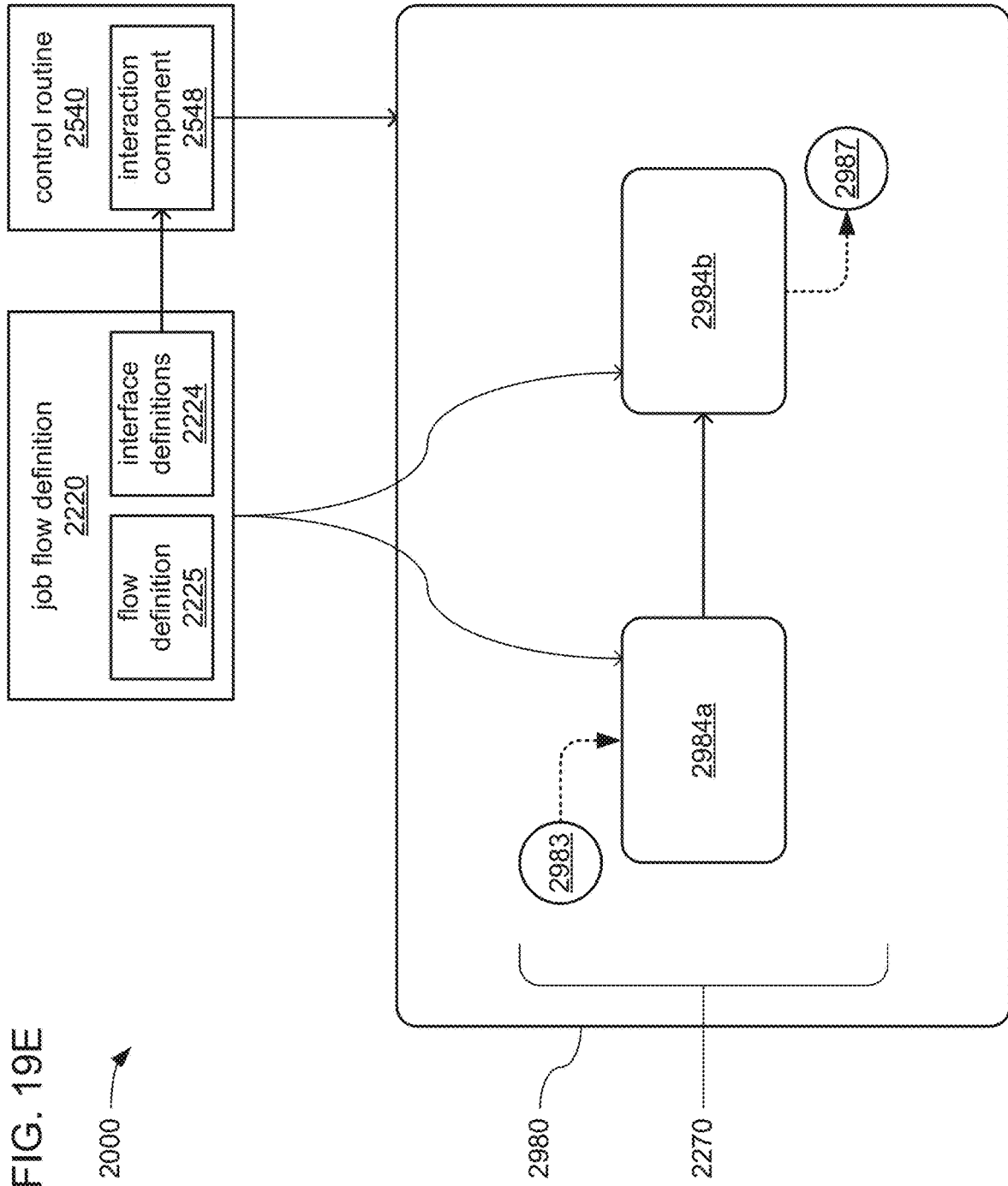

FIG. 19D

FIG. 19E



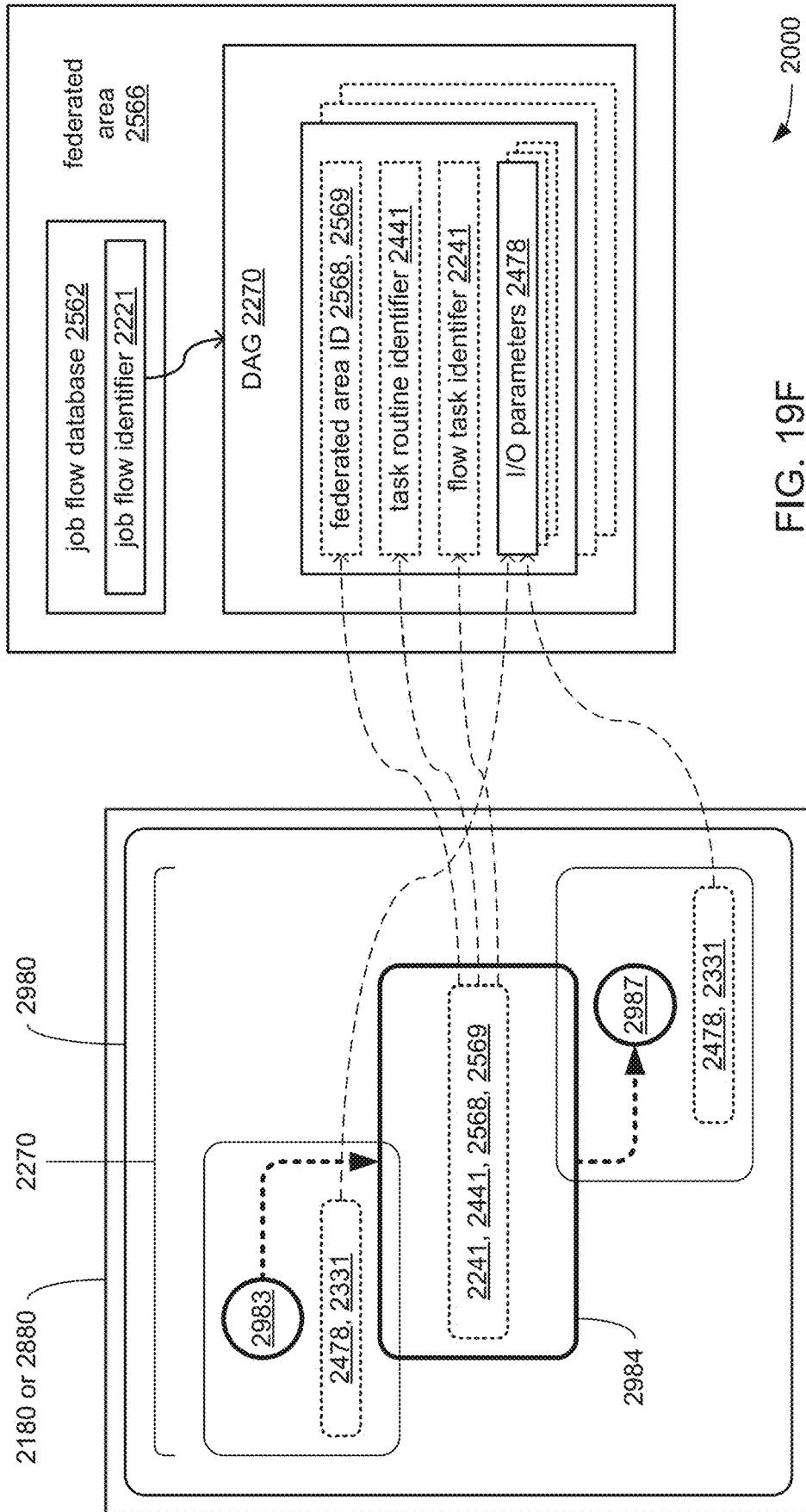

FIG. 19F

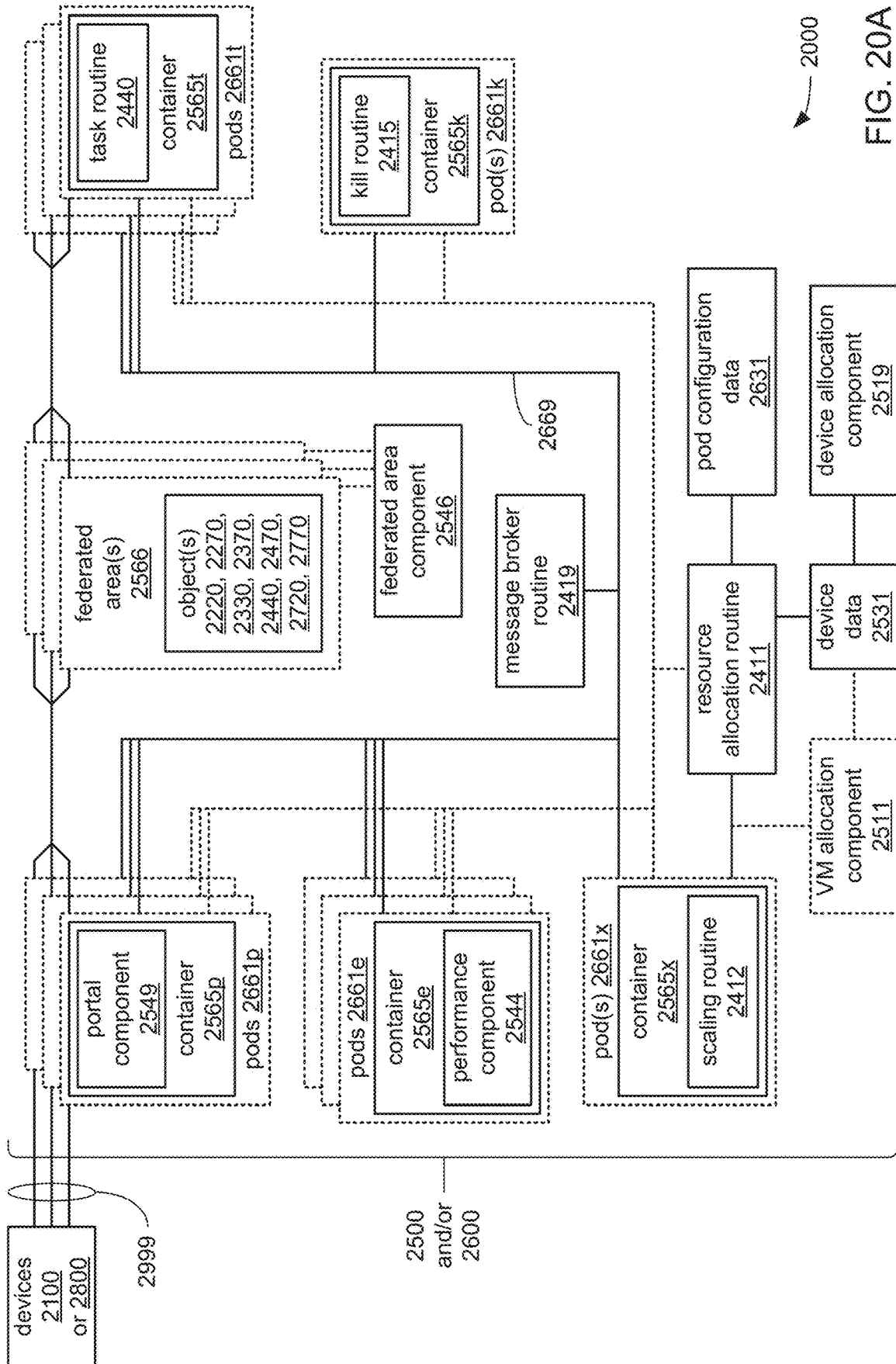

FIG. 20A

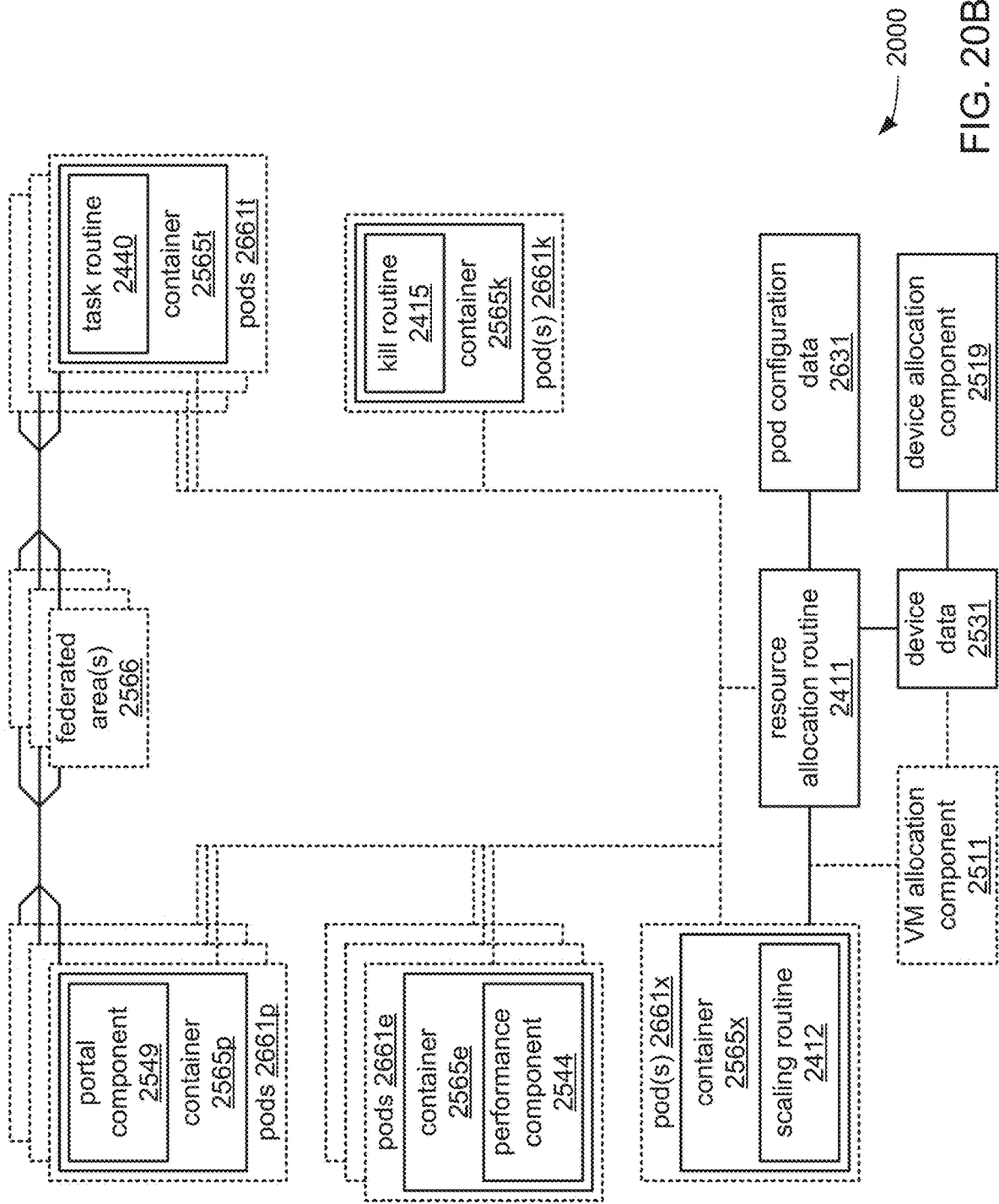
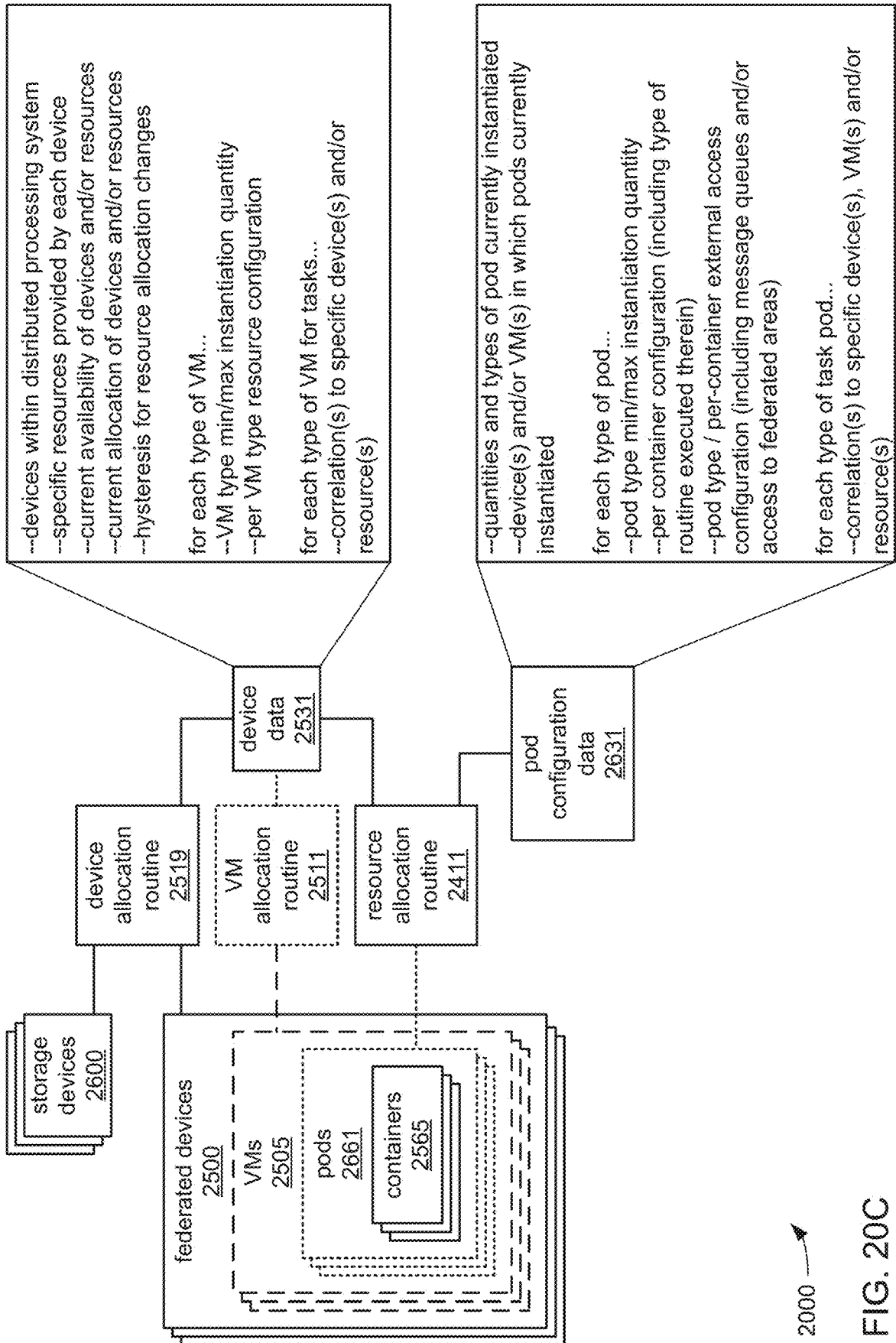

FIG. 20B



2000 →

FIG. 20C

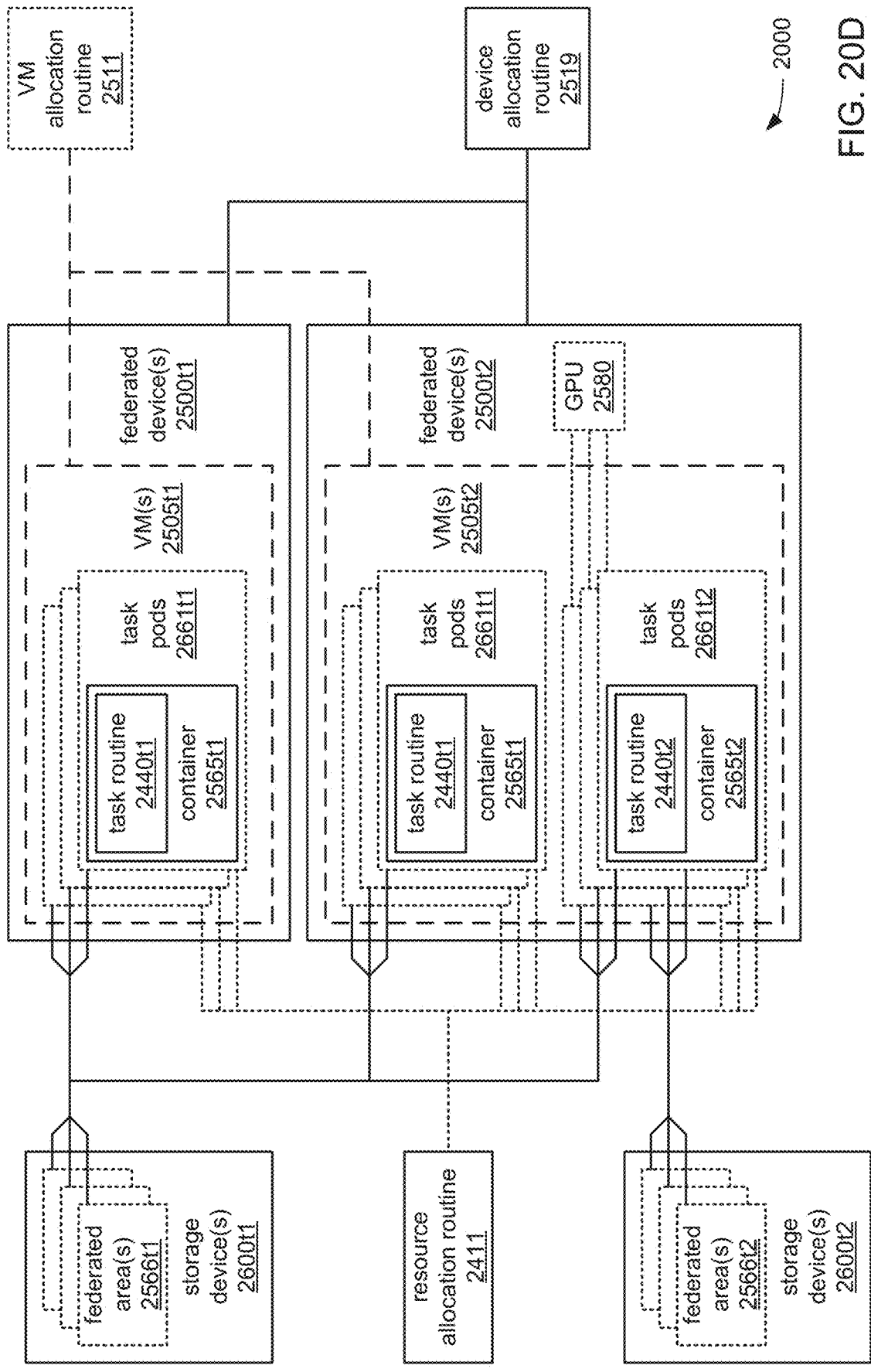

FIG. 20D

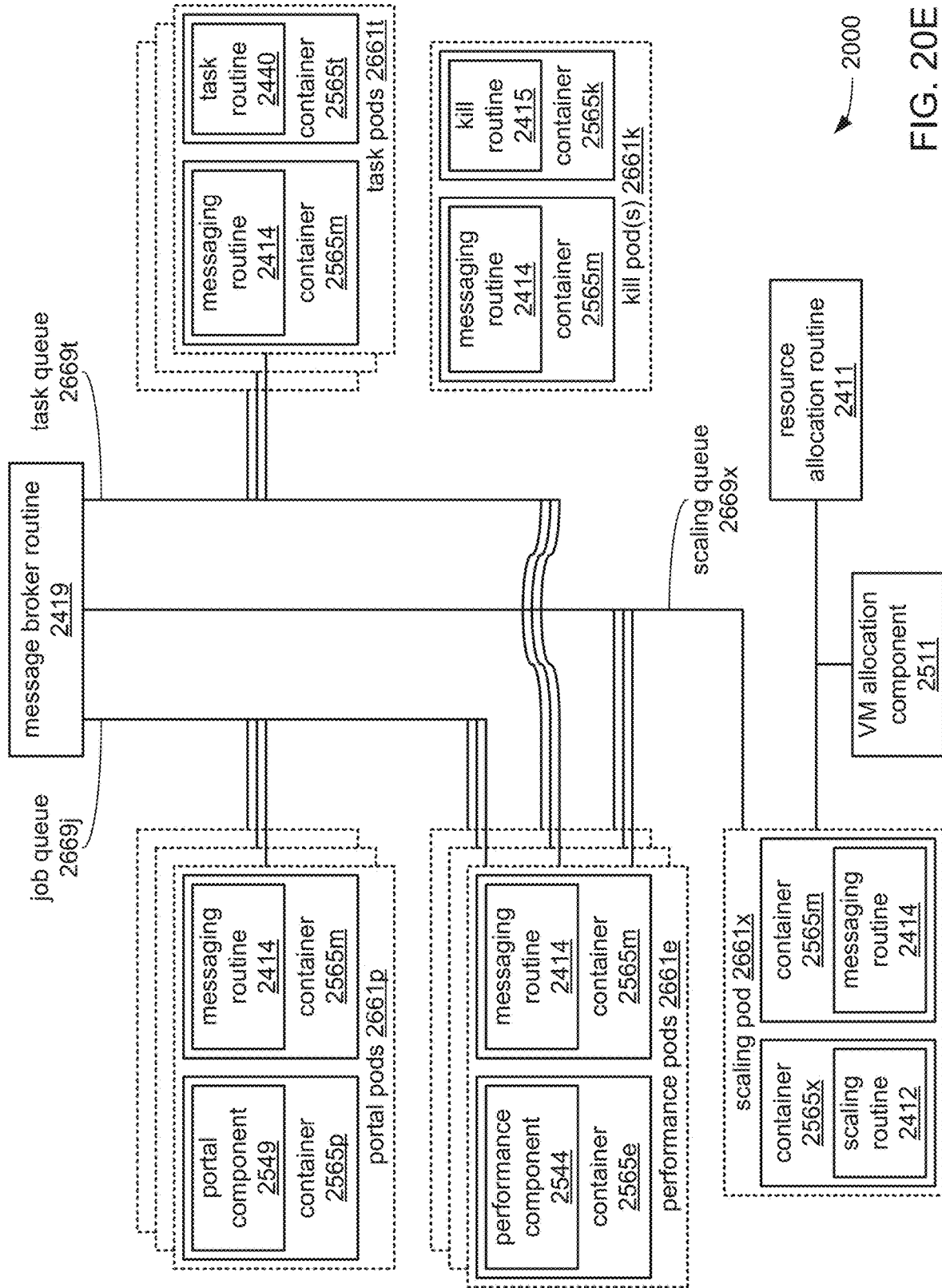

FIG. 20E

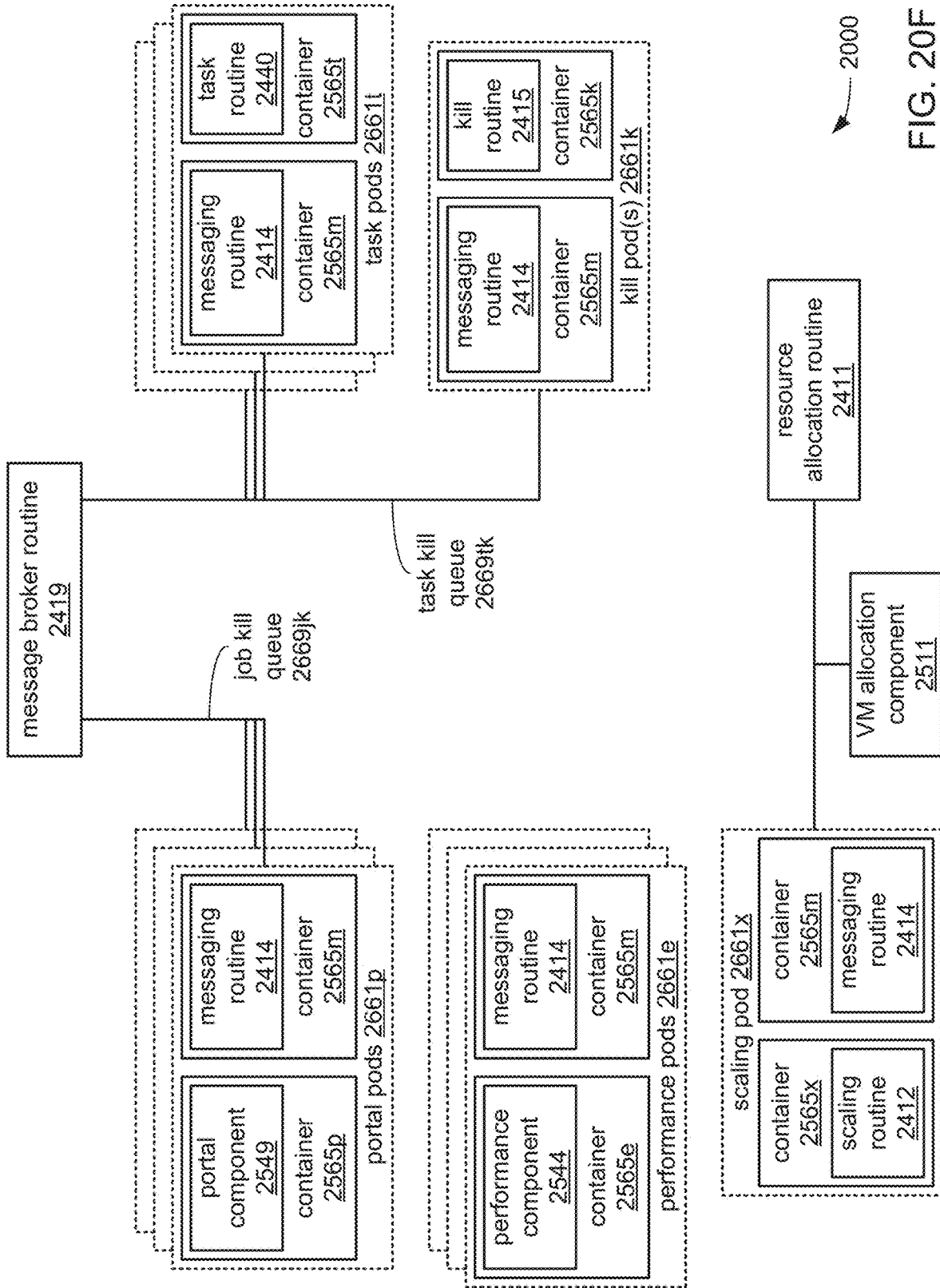

FIG. 20F

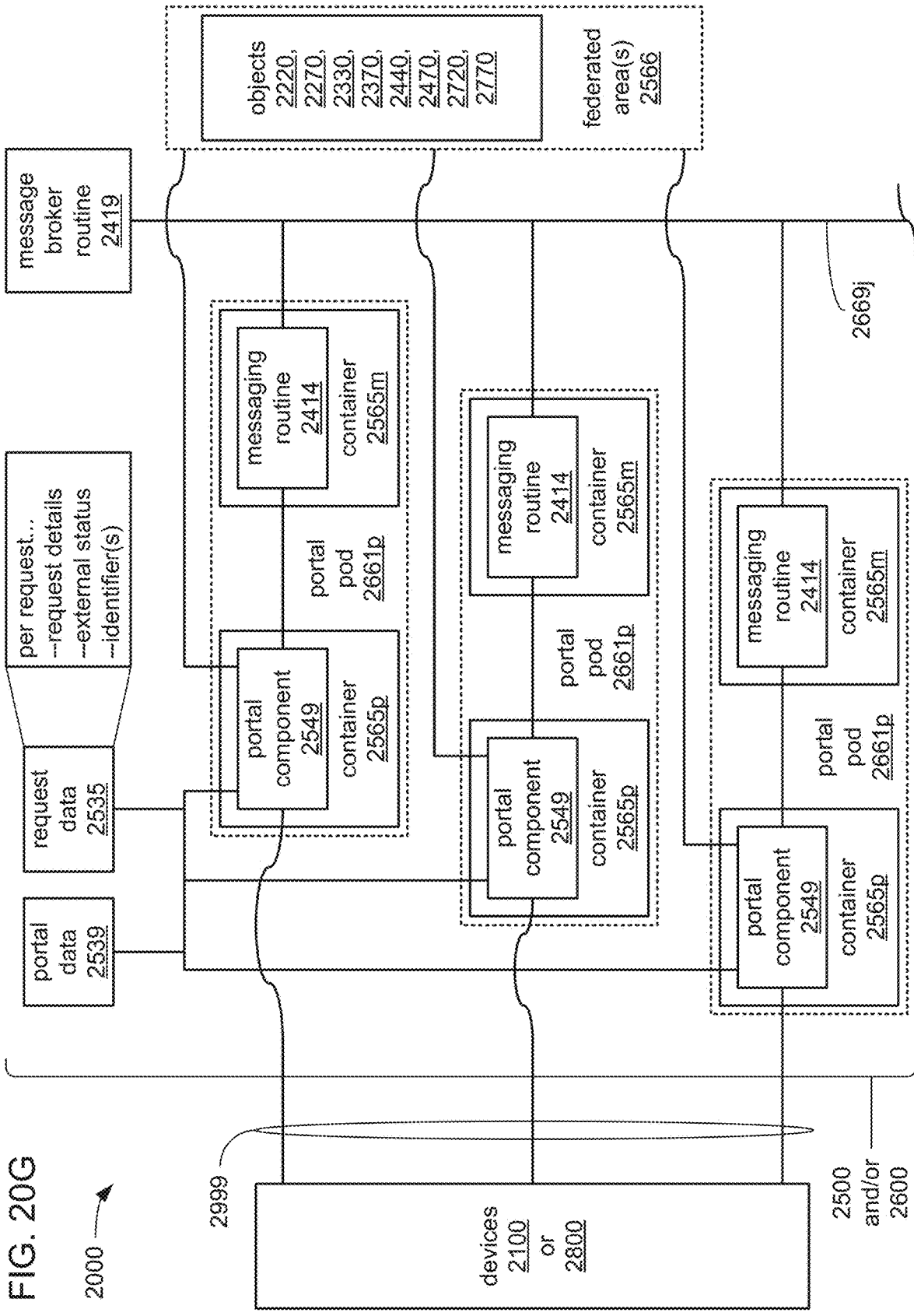
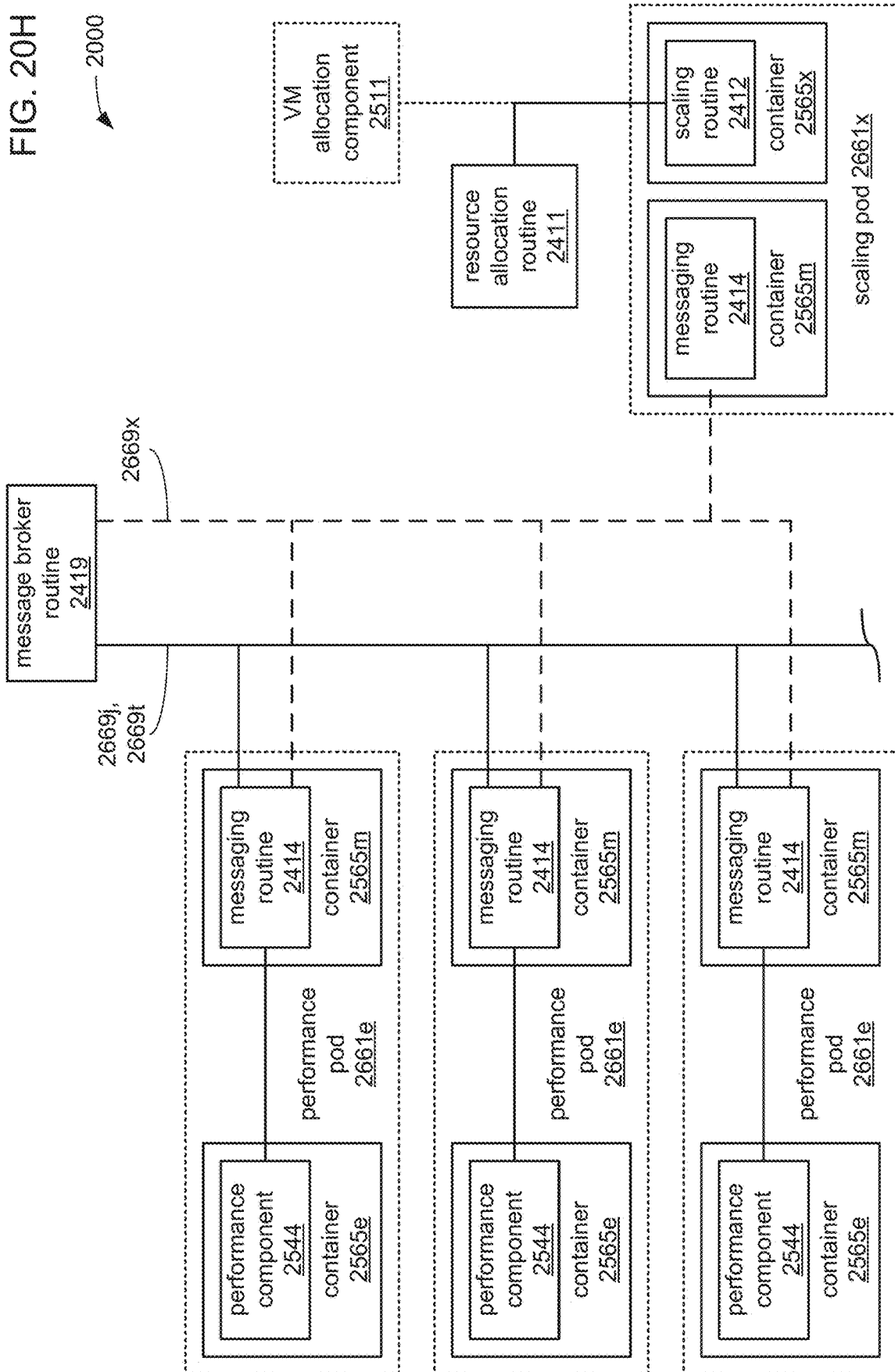

FIG. 20H



2000

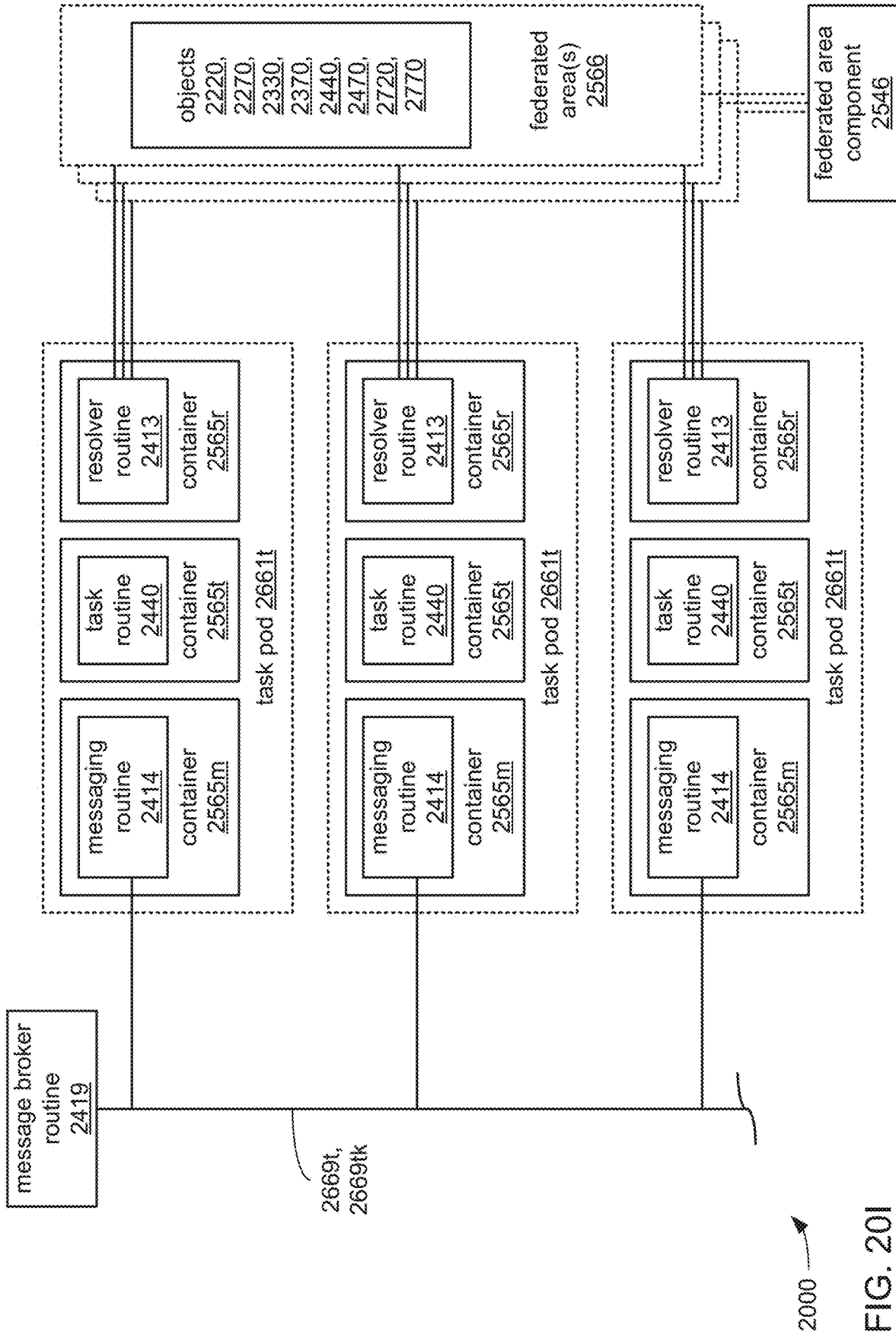

FIG. 201

FIG. 20J

2000

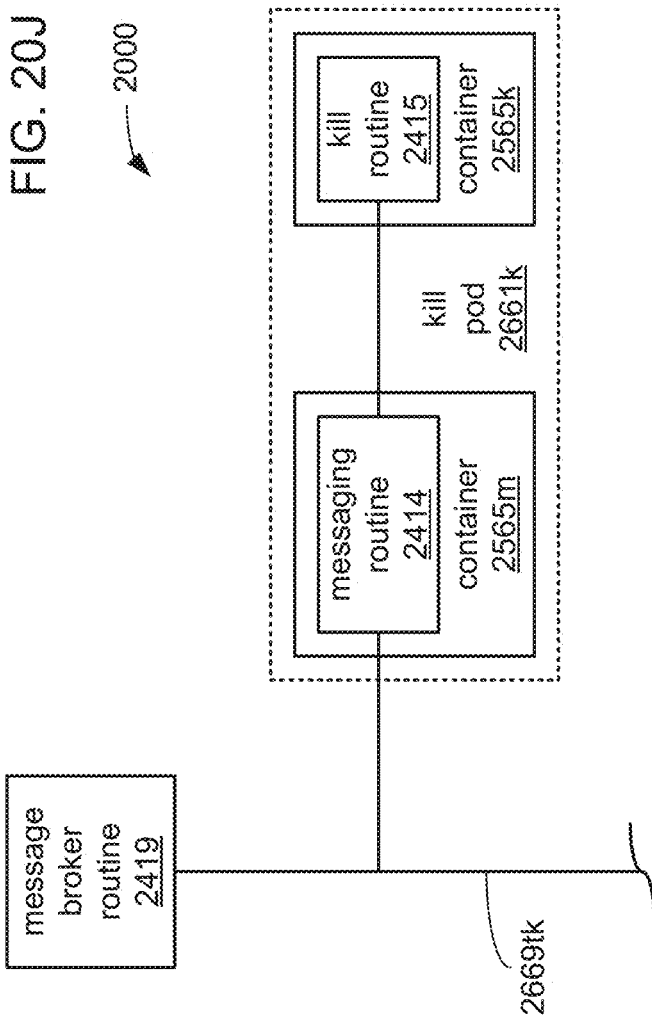

FIG. 21A

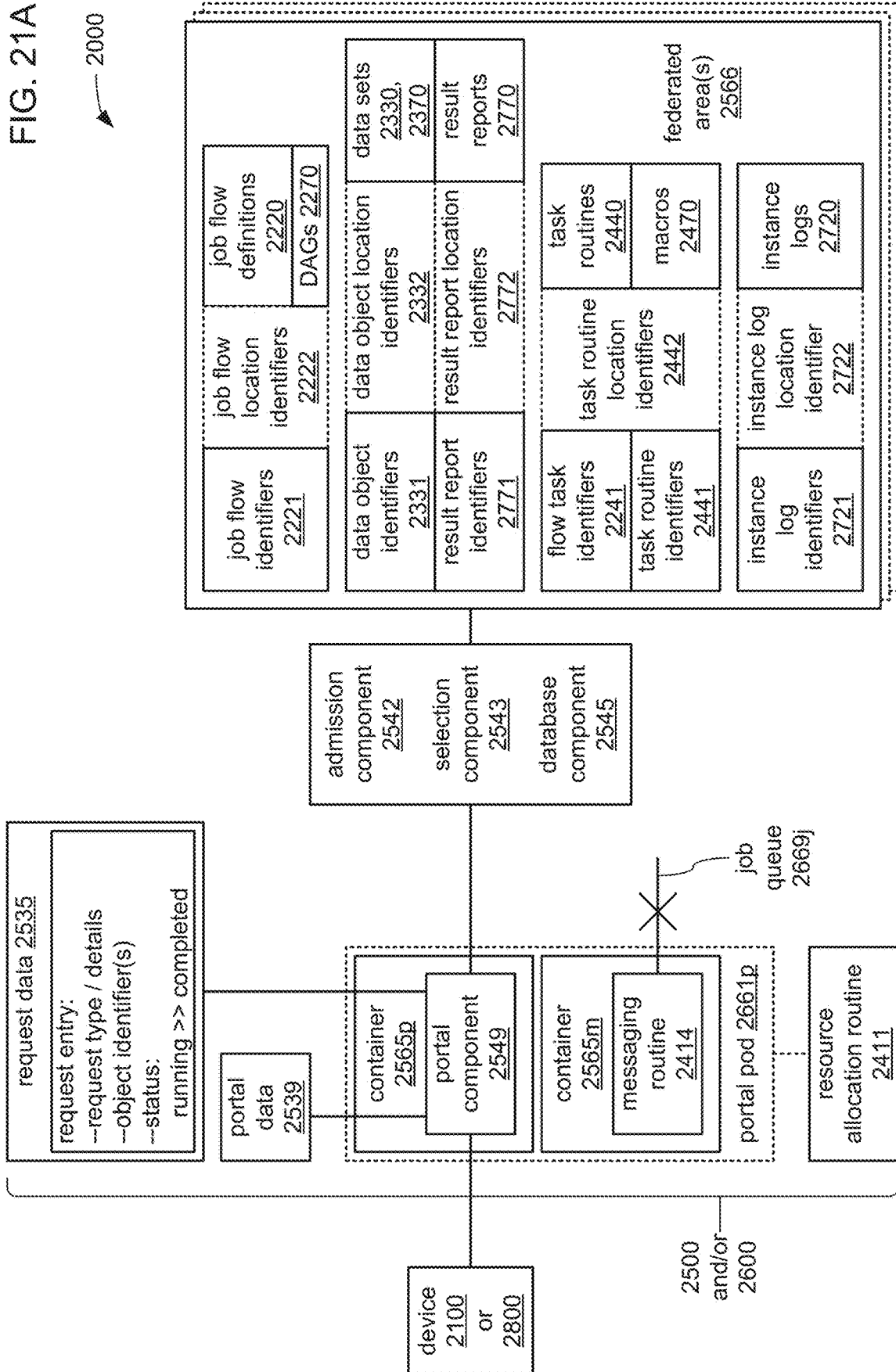
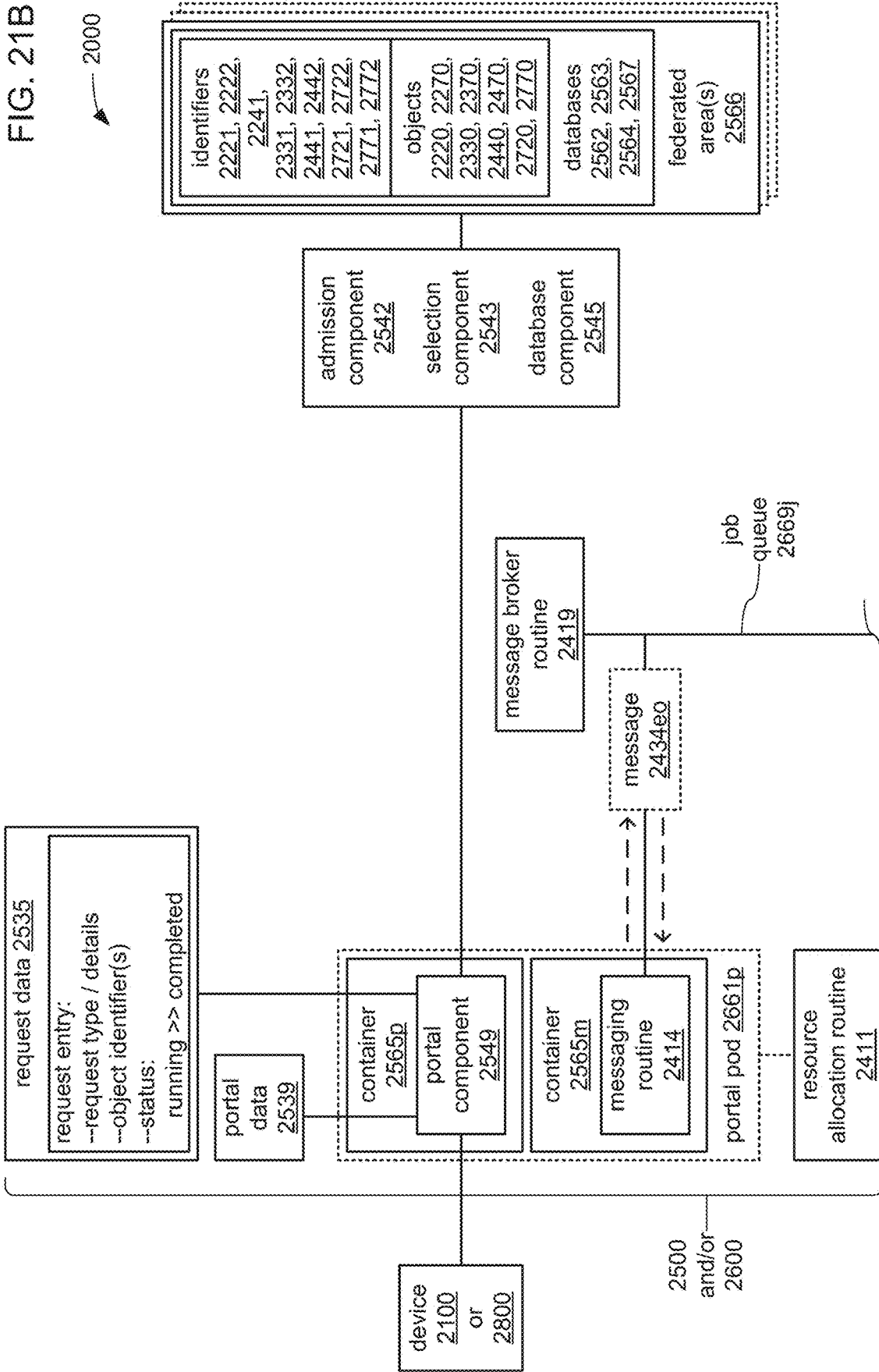

FIG. 21B



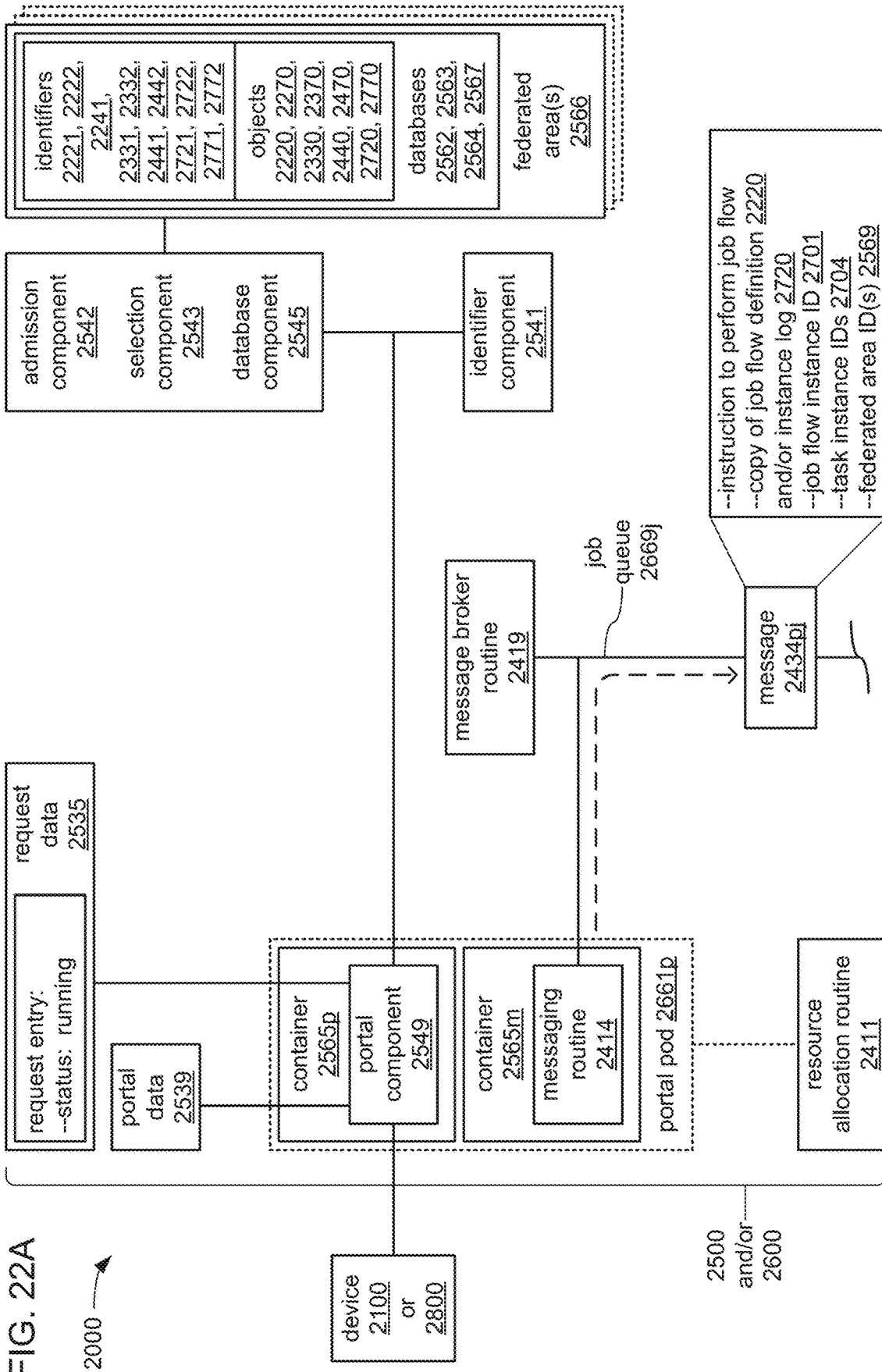

FIG. 22A

2000

2500 and/or 2600

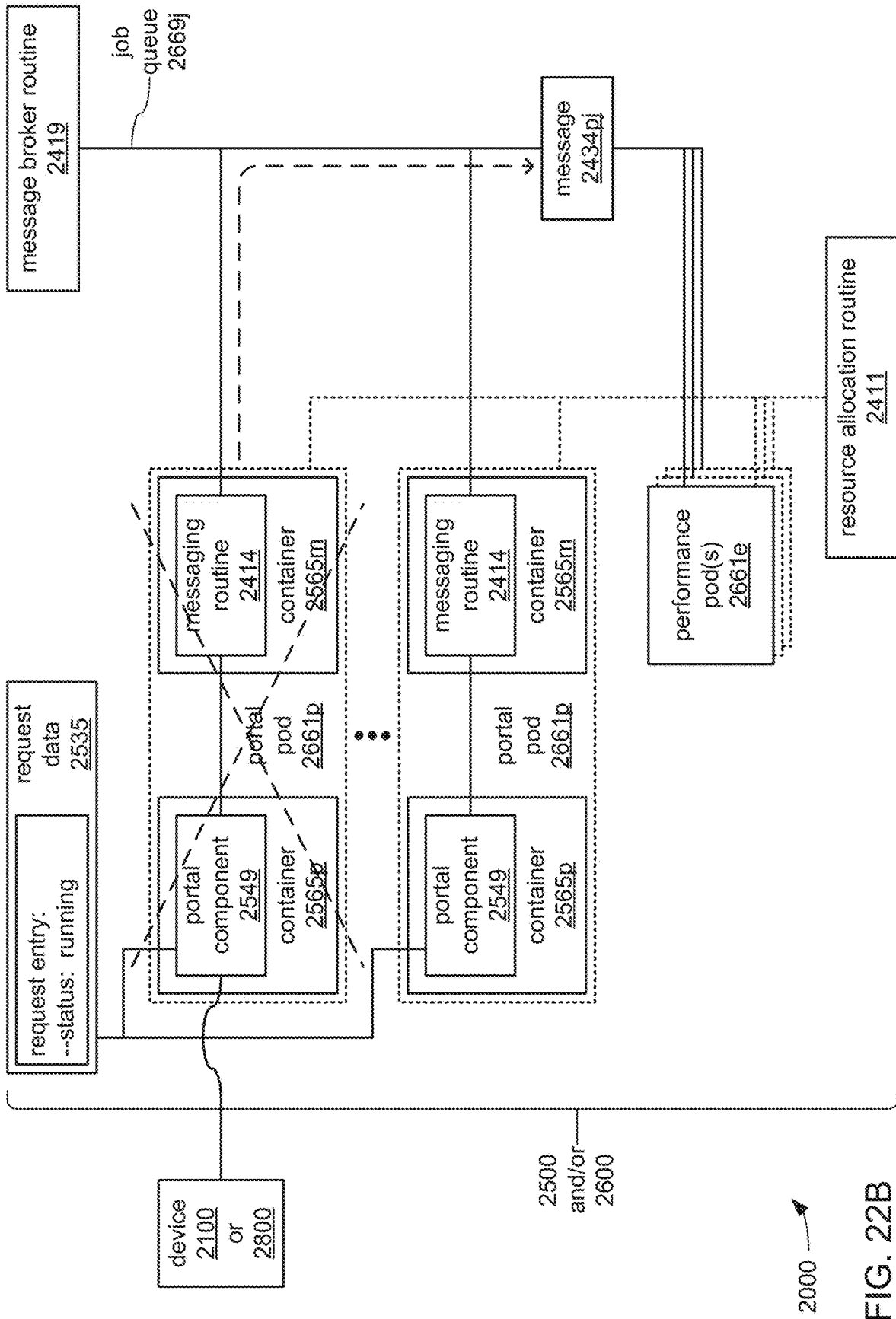

FIG. 22B

FIG. 22C

2000 →

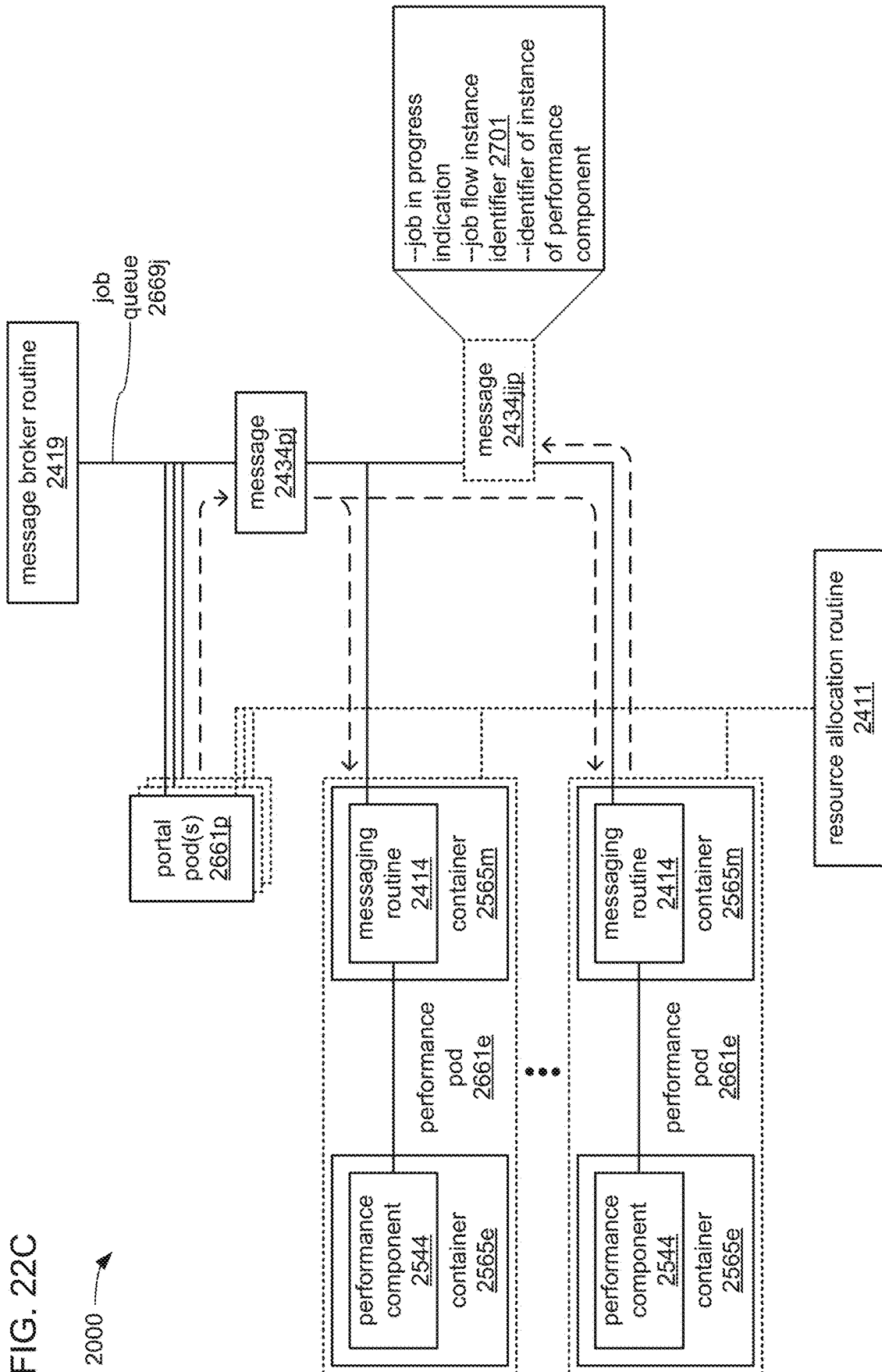
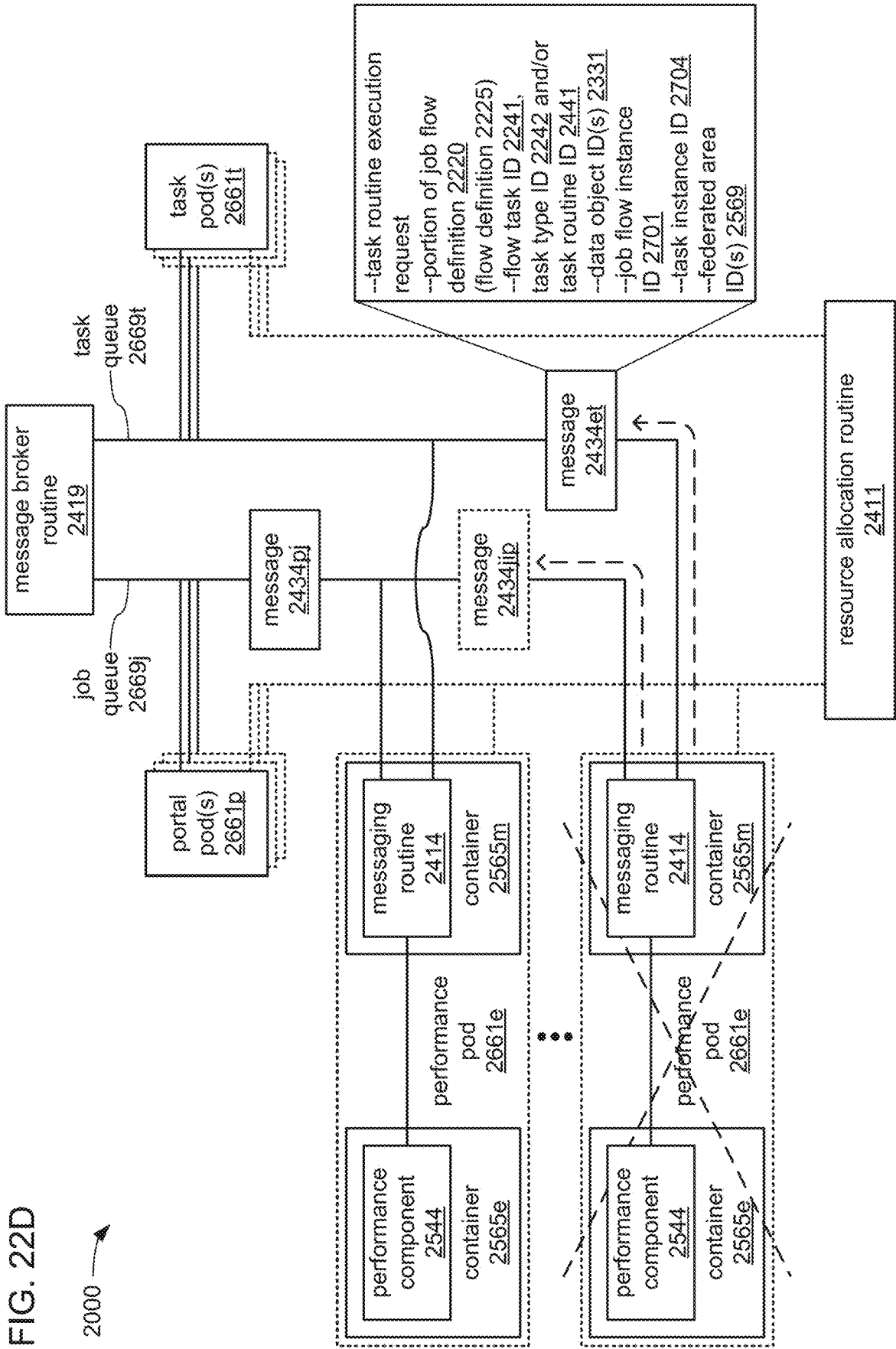
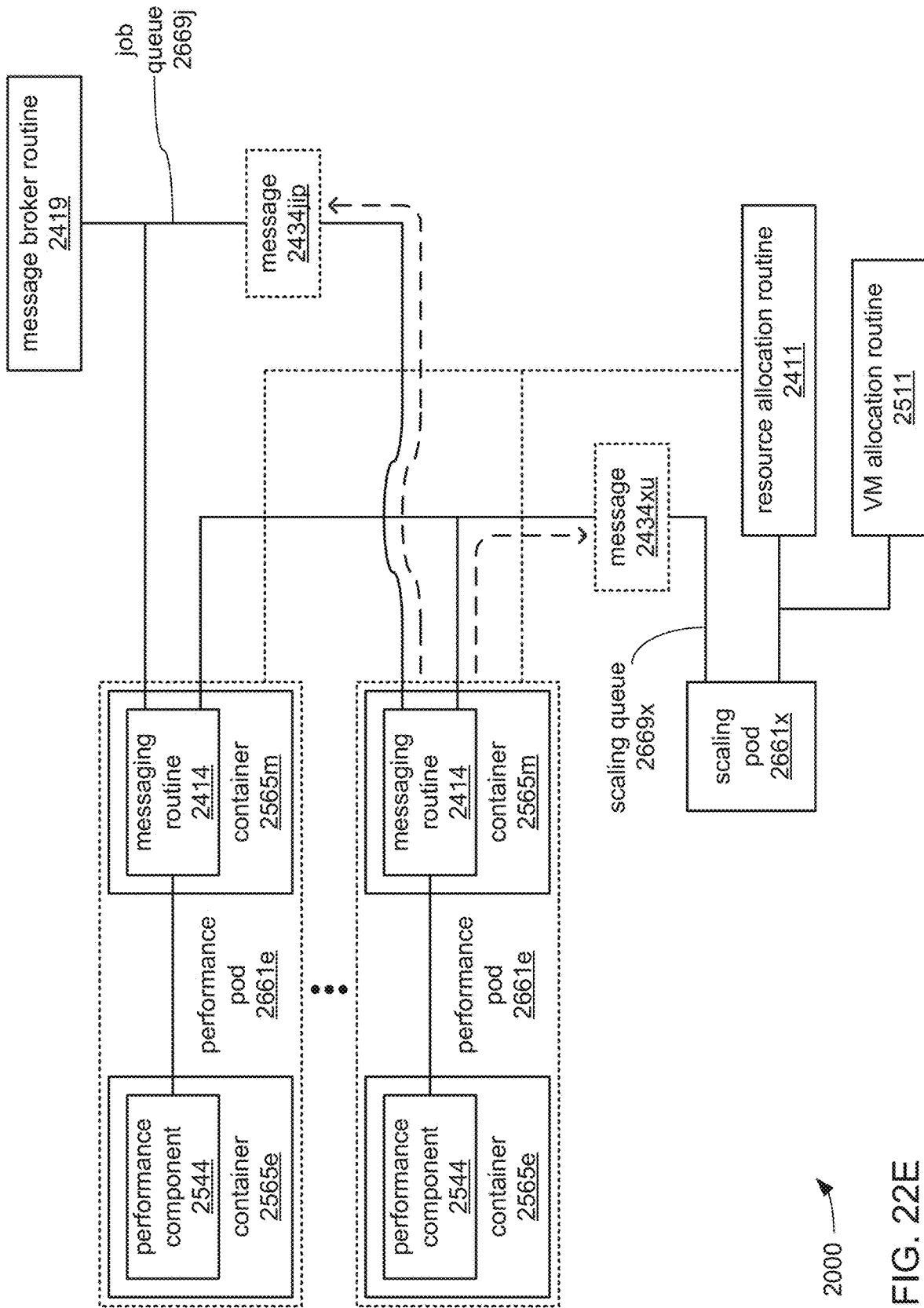

FIG. 22D





2000 →

FIG. 22E

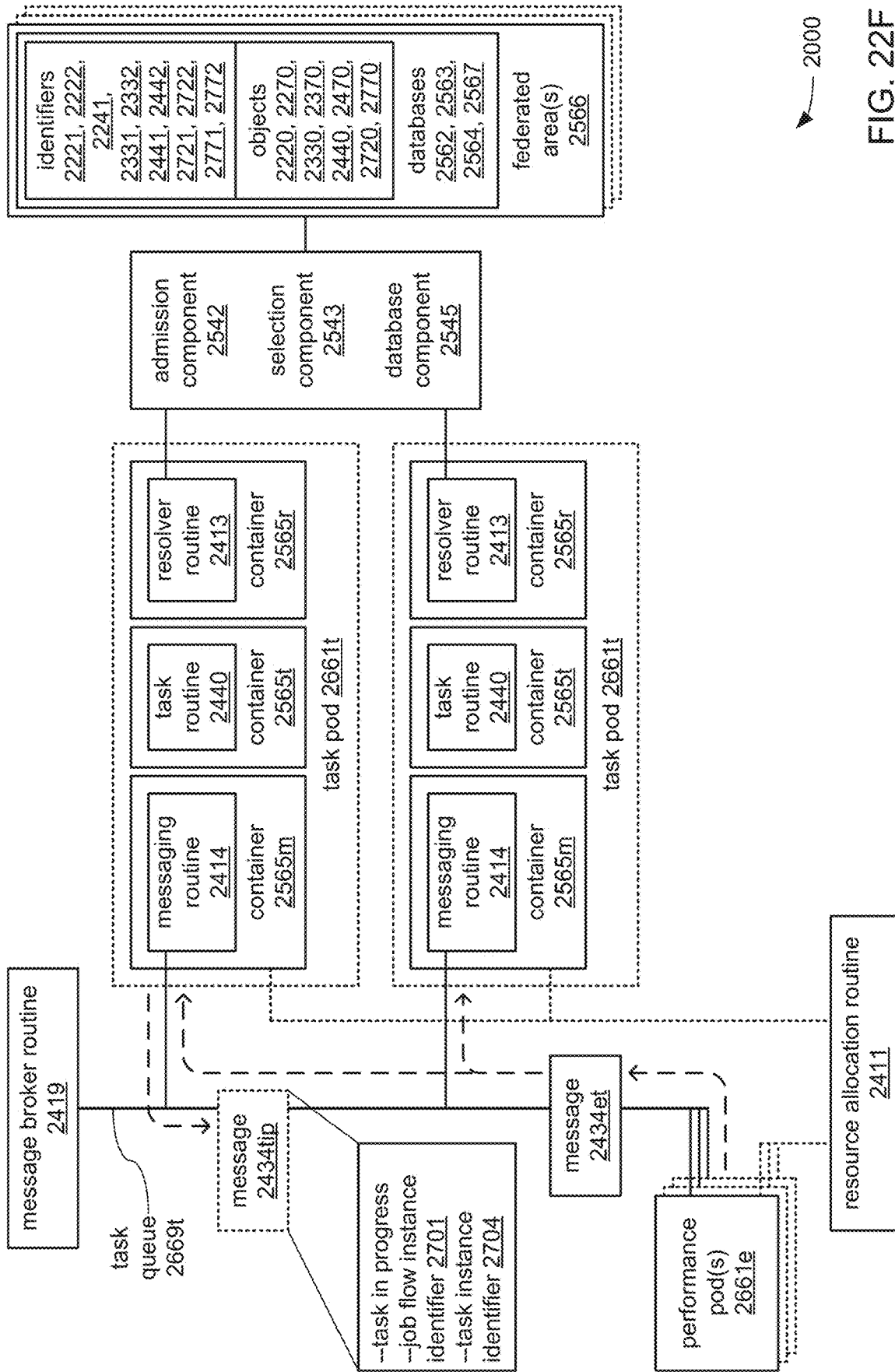

2000

FIG. 22F

FIG. 22G

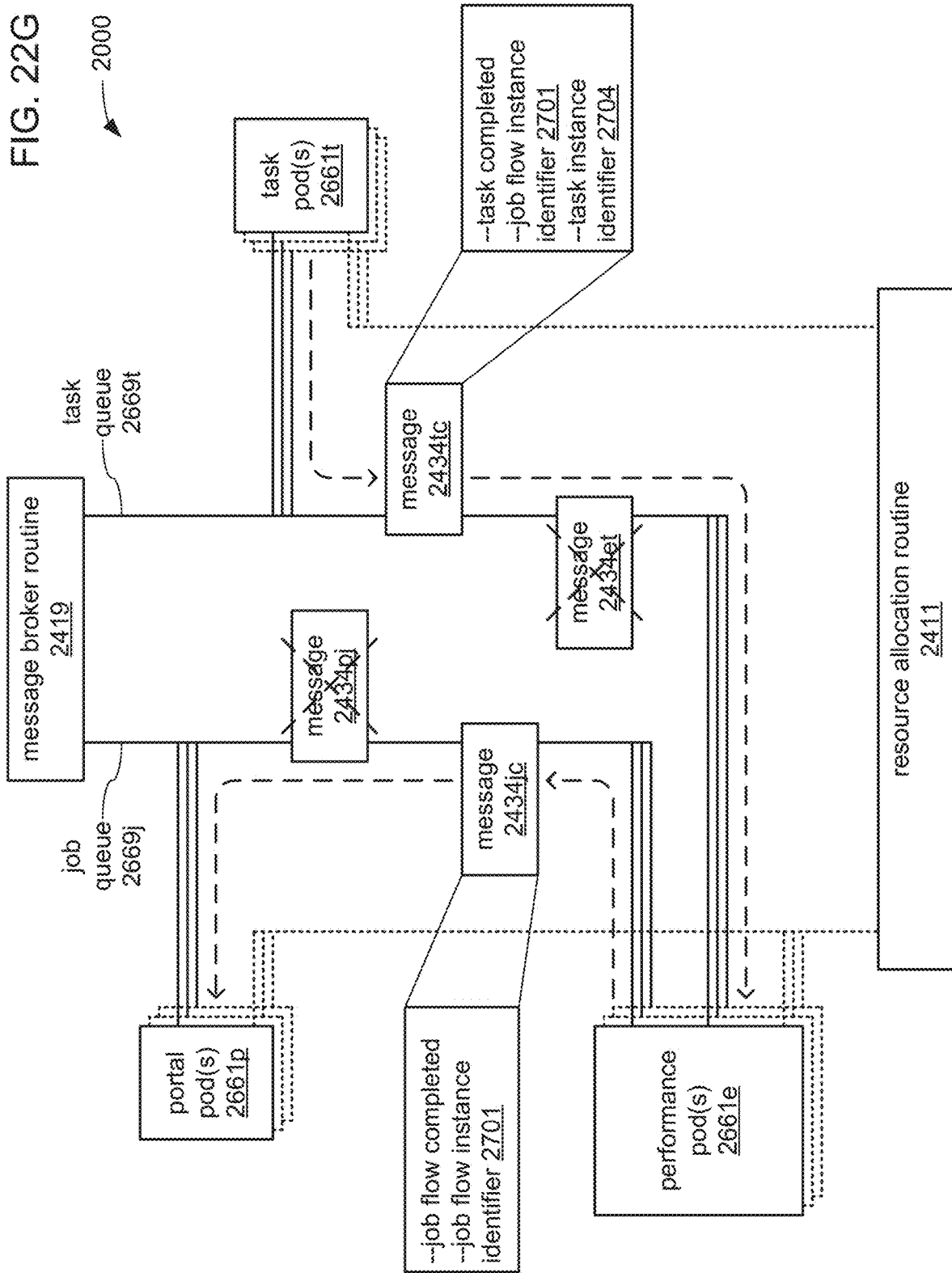

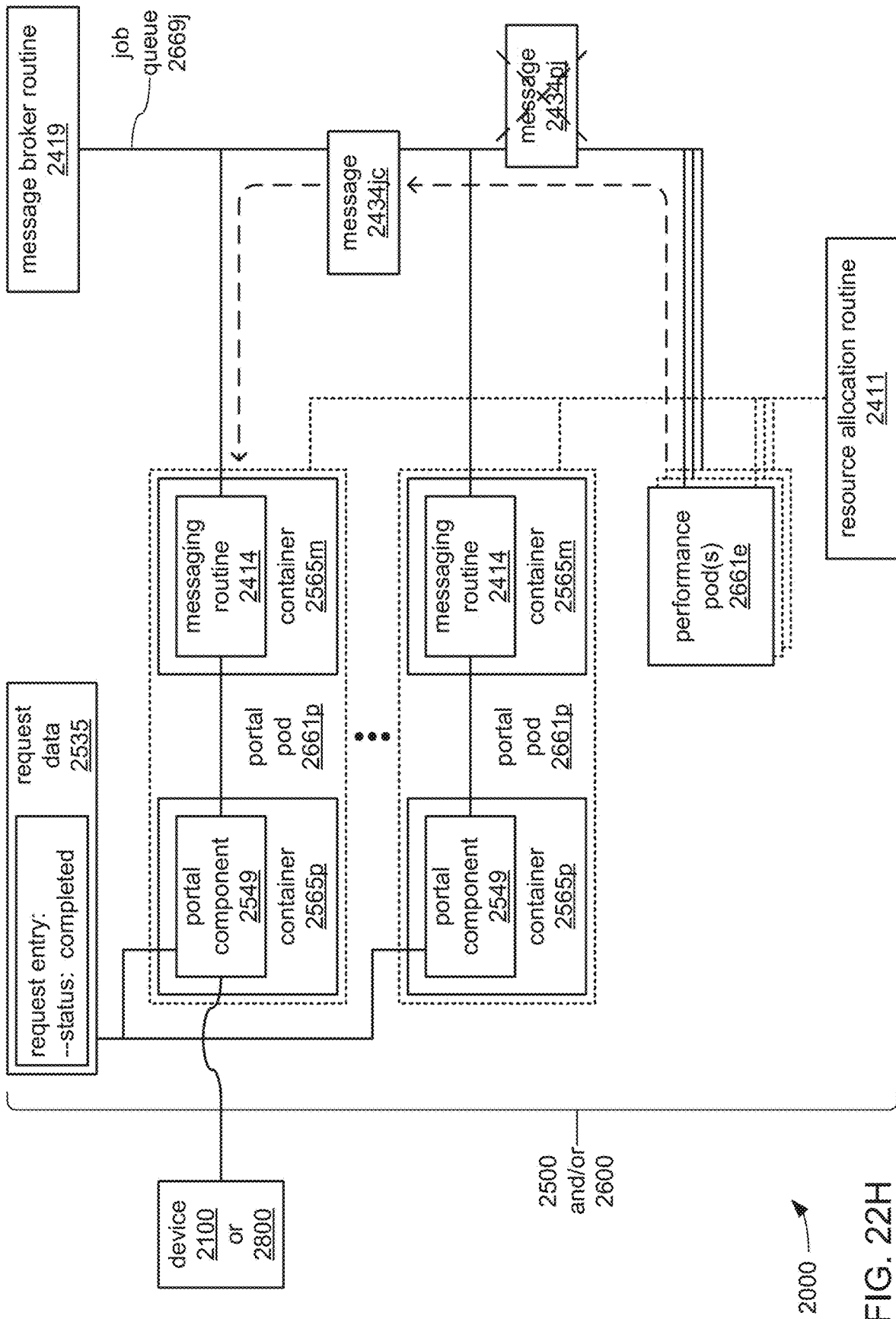
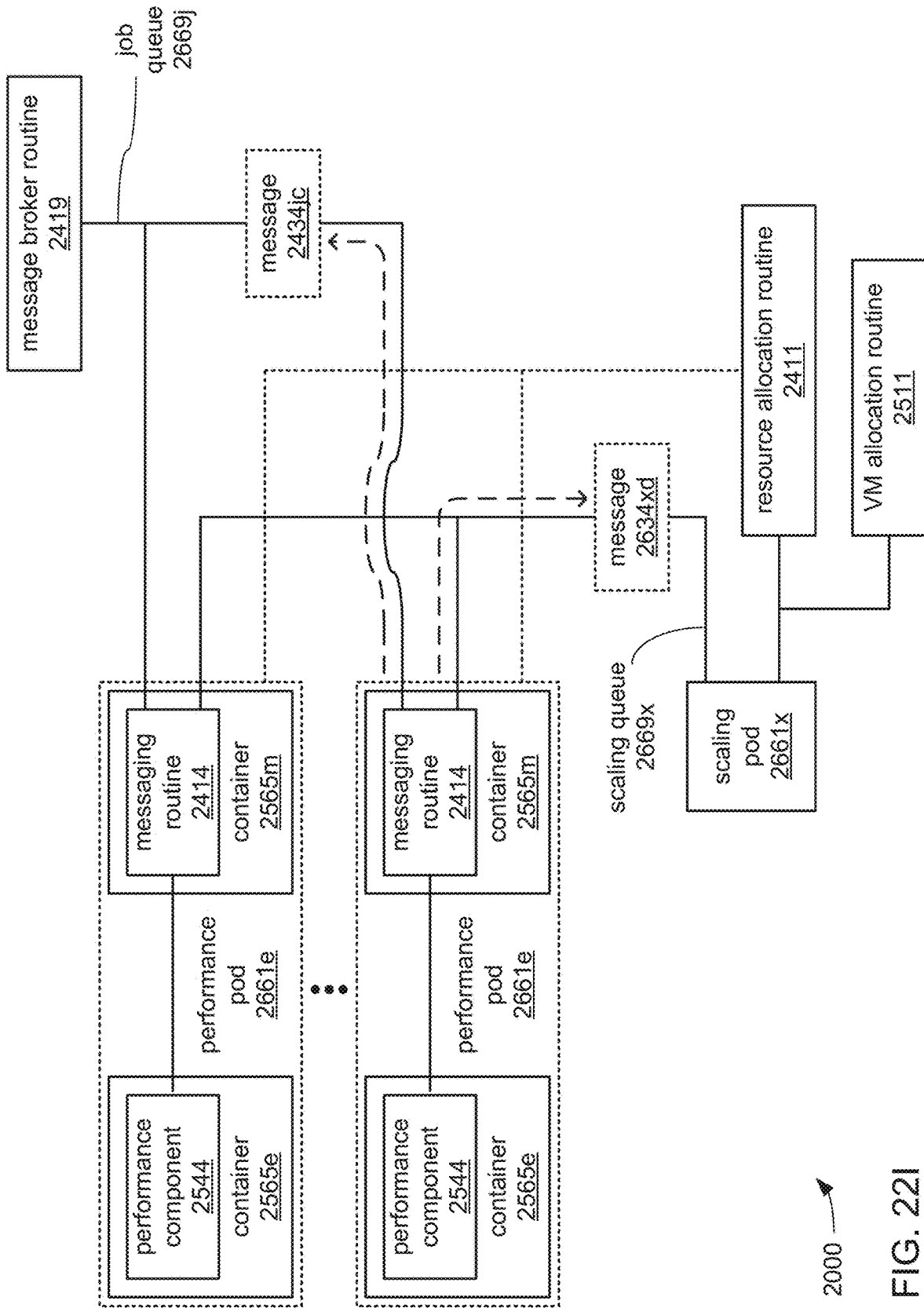

FIG. 22H



2000 →
FIG. 22I

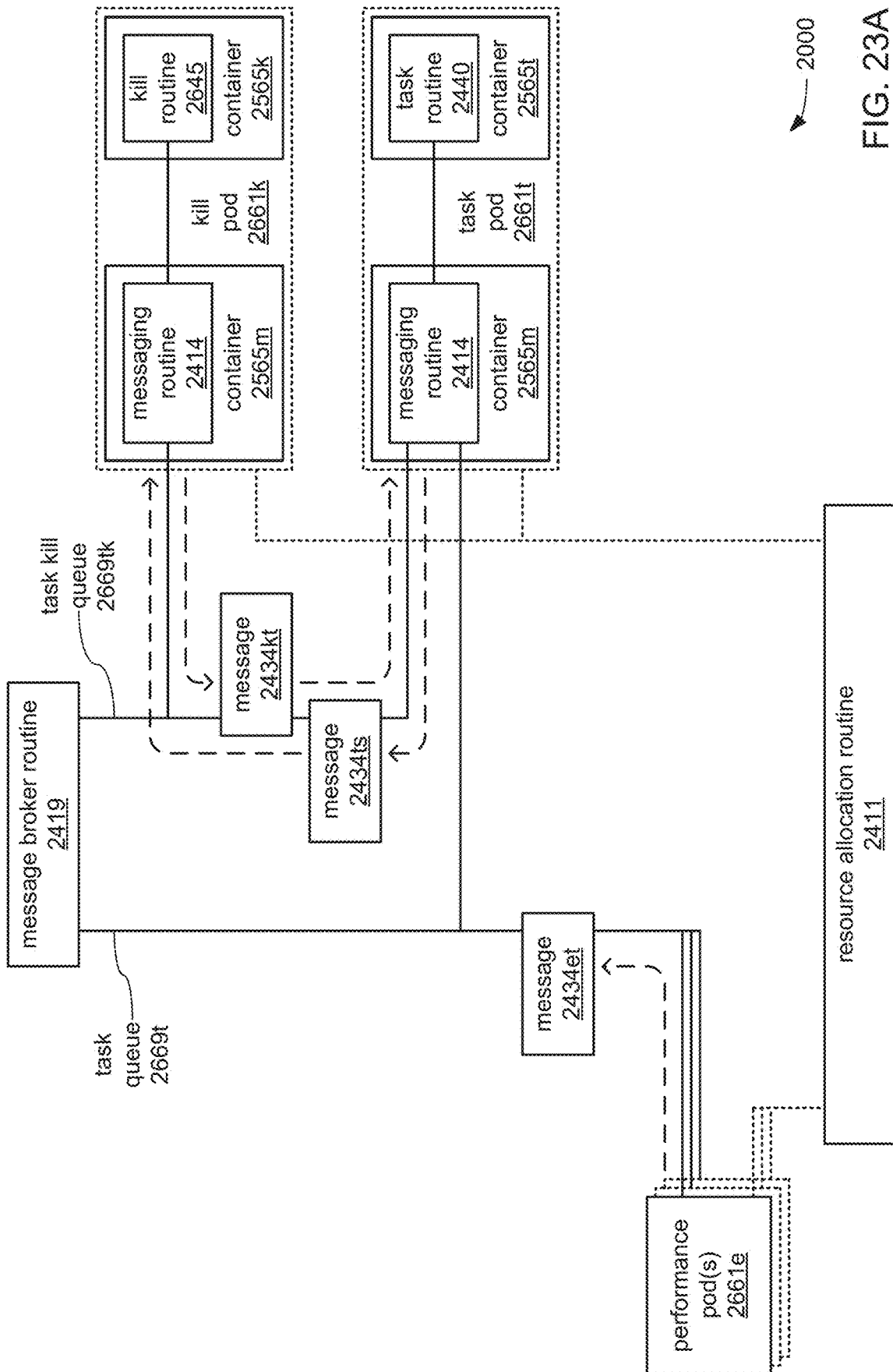

FIG. 23A

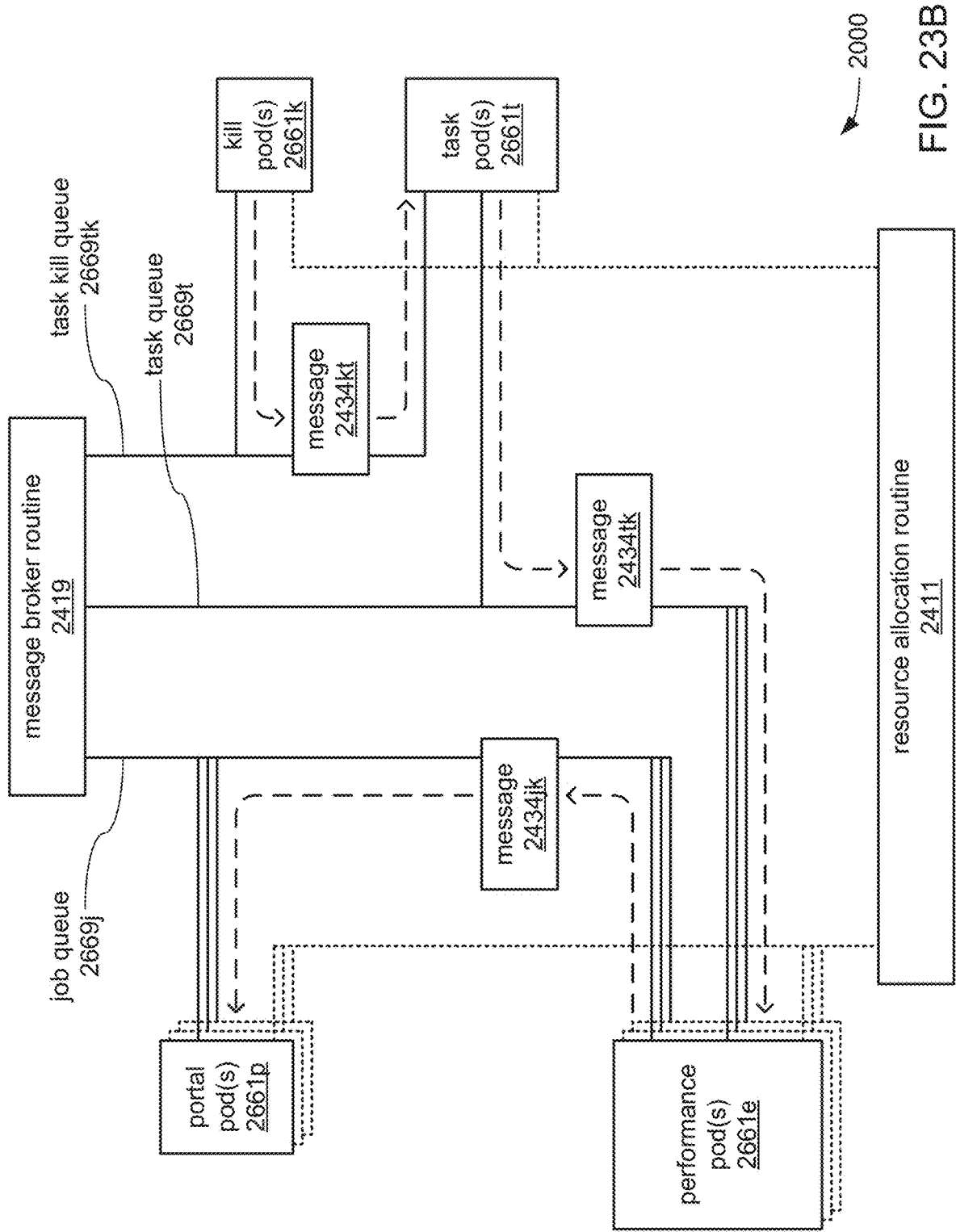

FIG. 23B

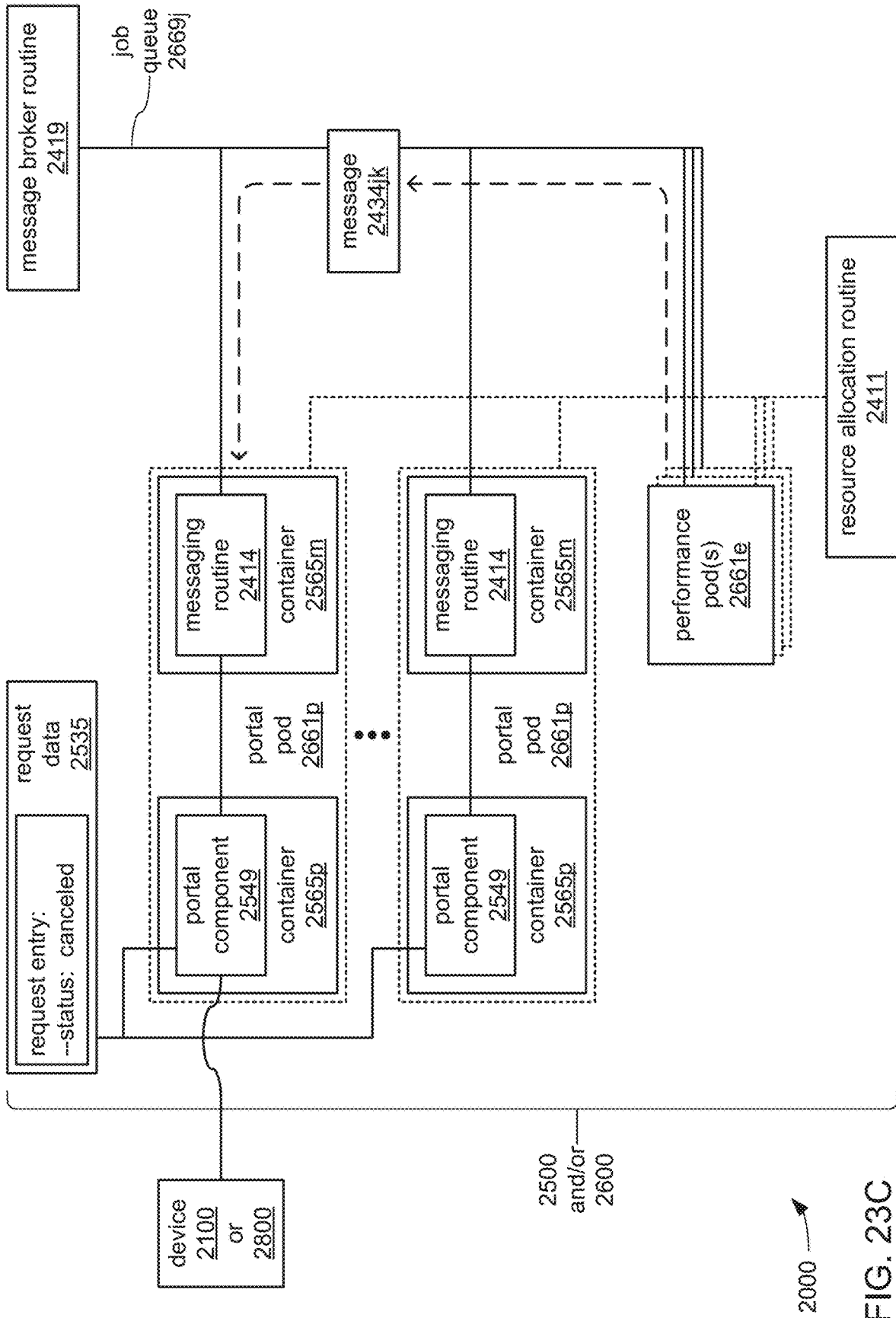

FIG. 23C

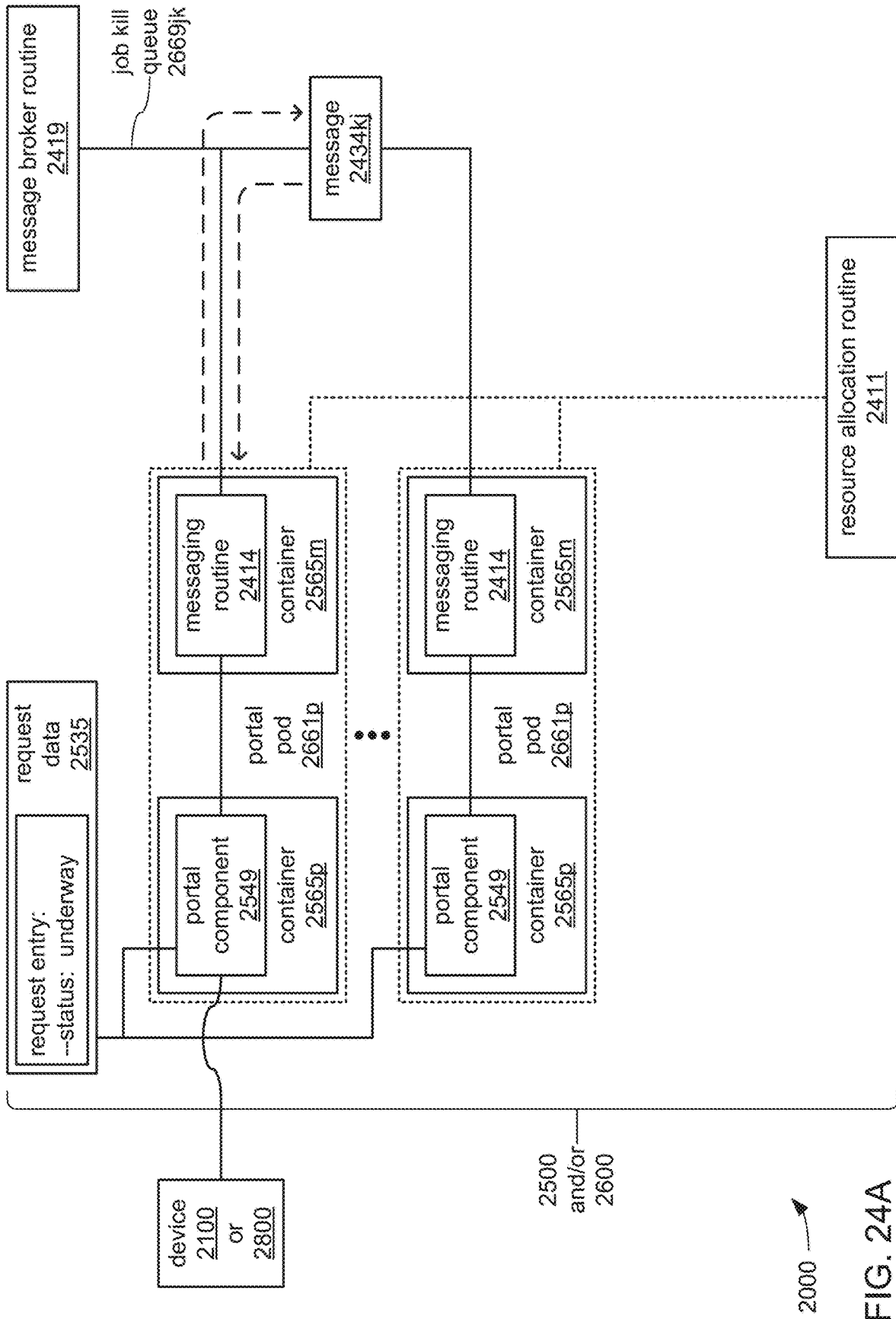

FIG. 24A

FIG. 24B

2000

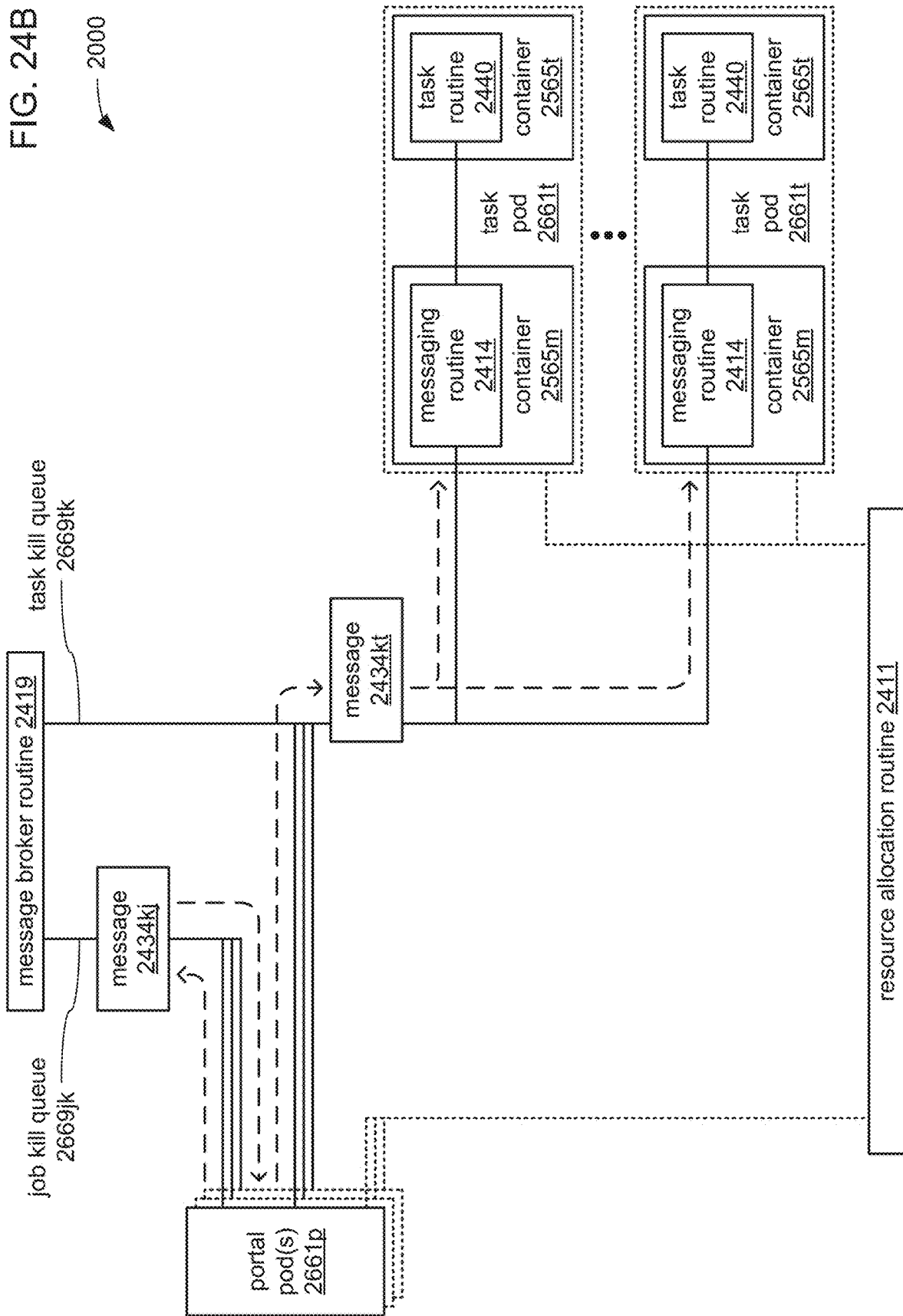
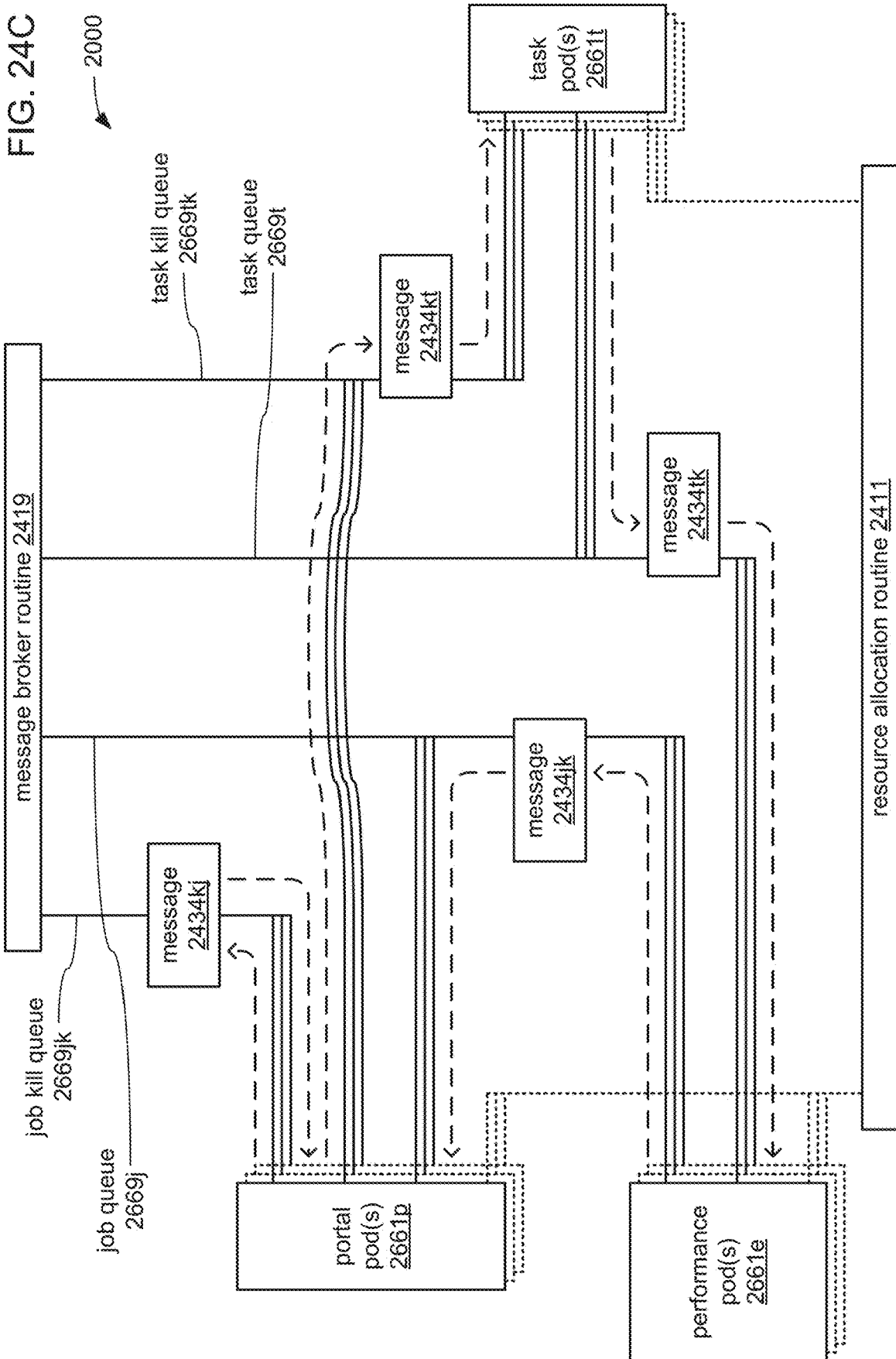

FIG. 24C



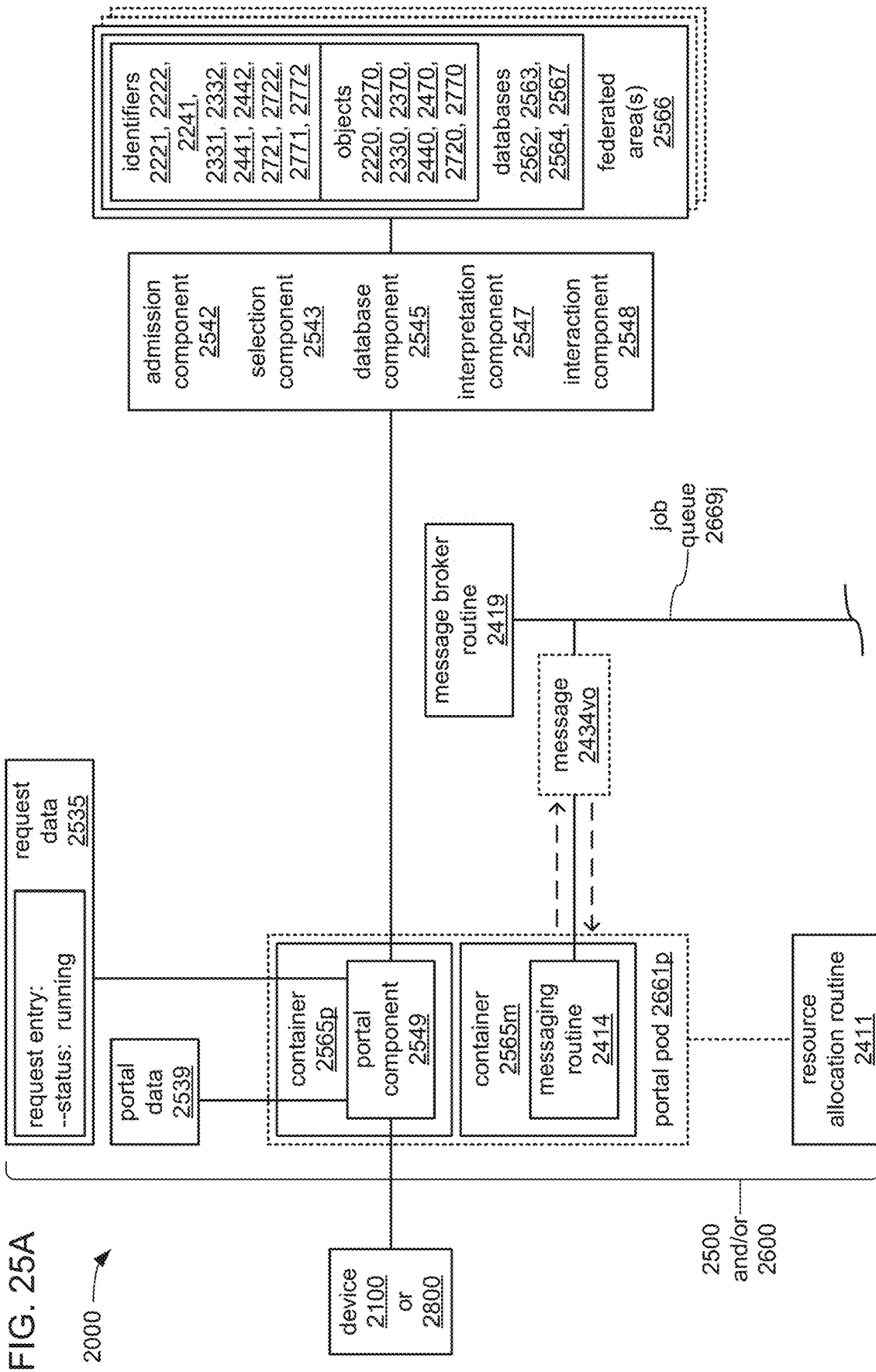

FIG. 25A

2000

2500
and/or
2600

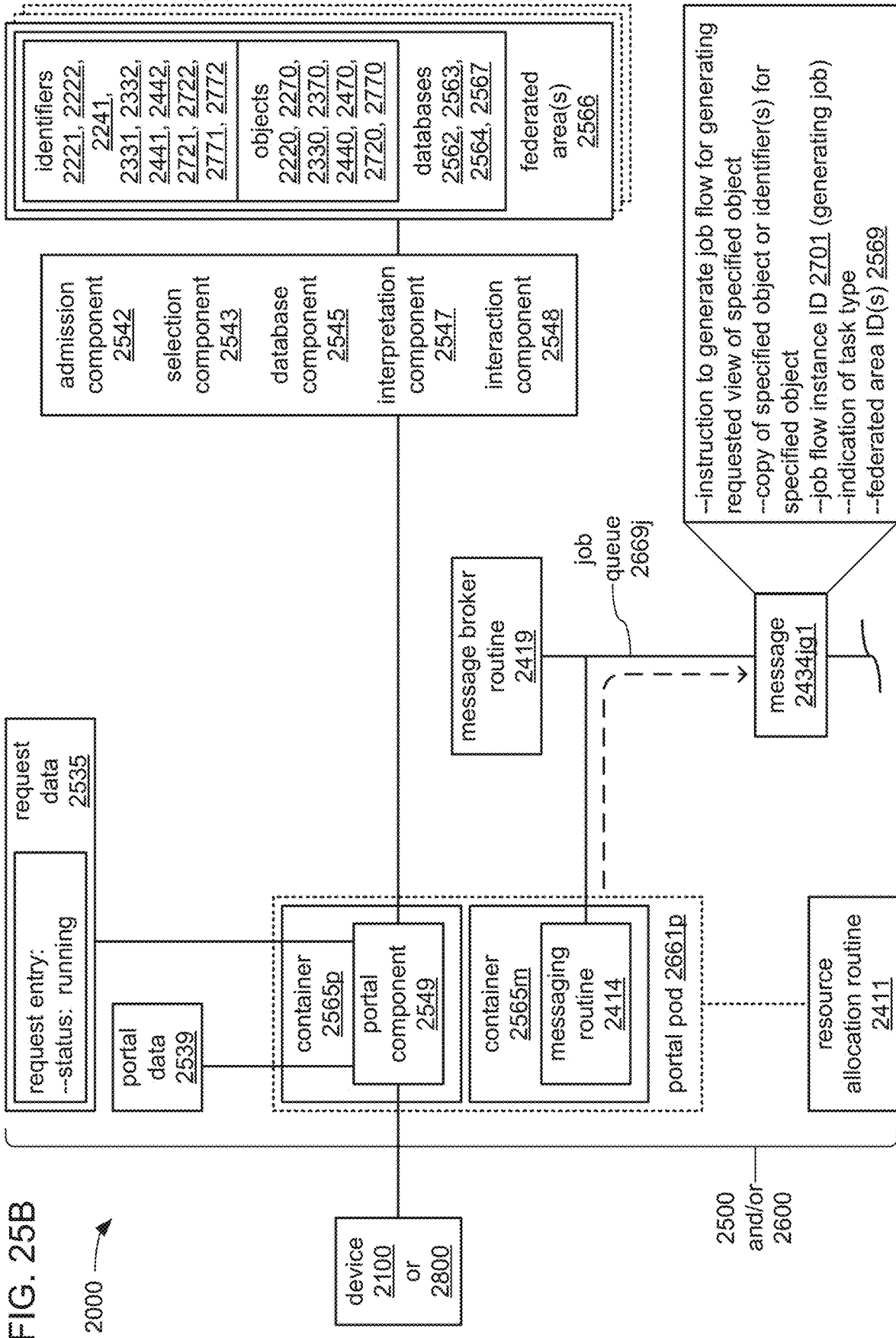

FIG. 25C

2000 →

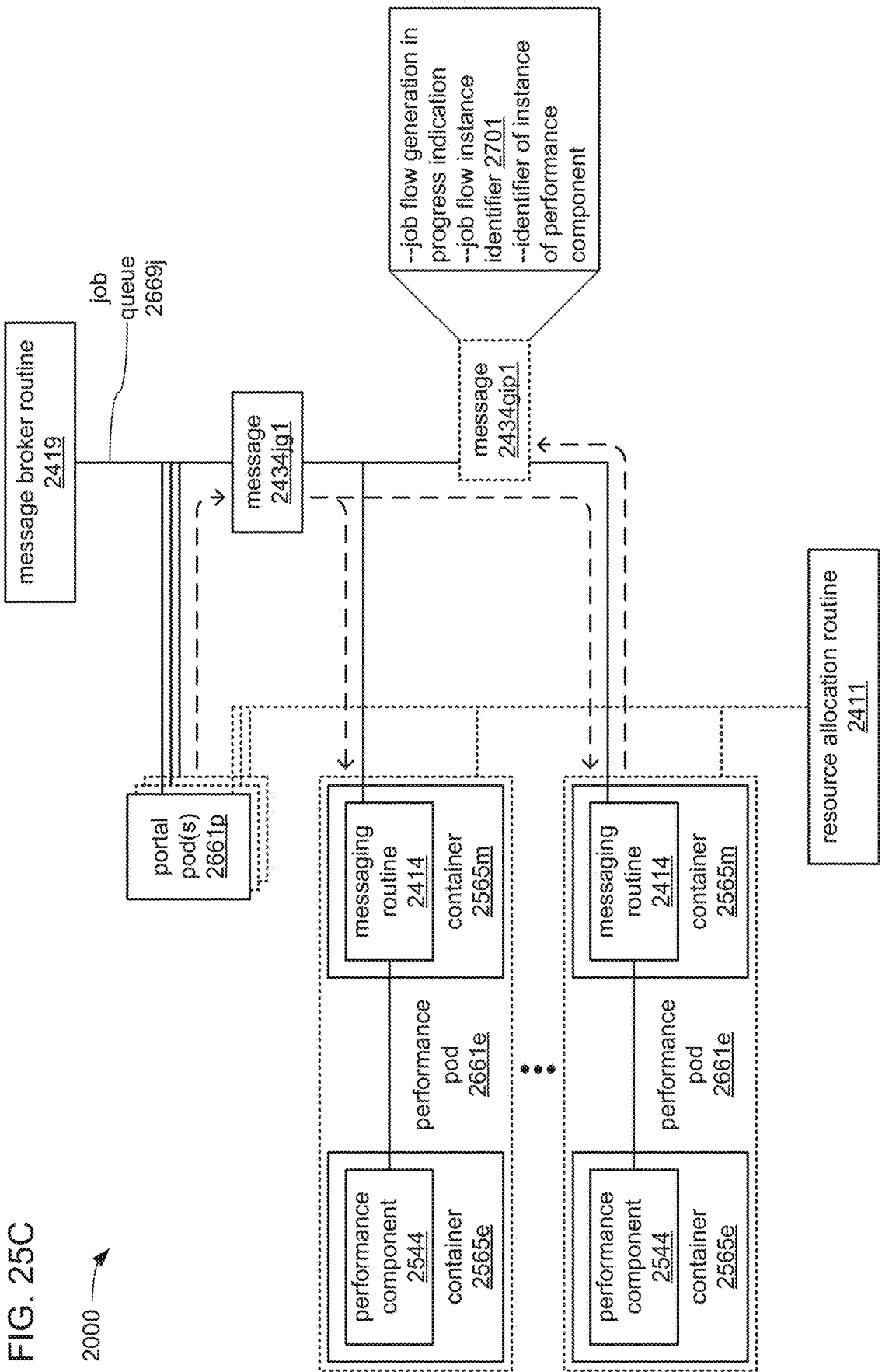
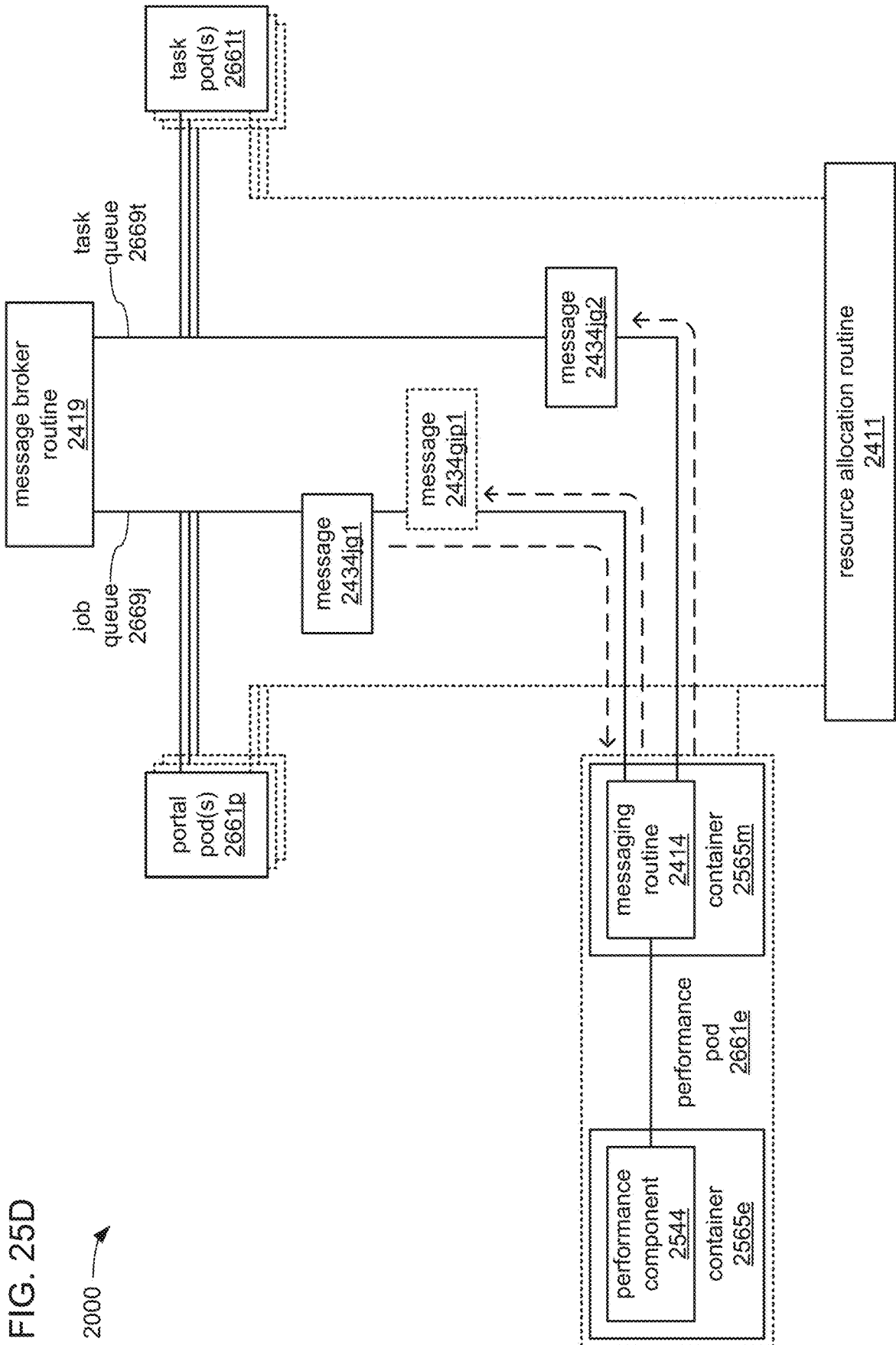

FIG. 25D



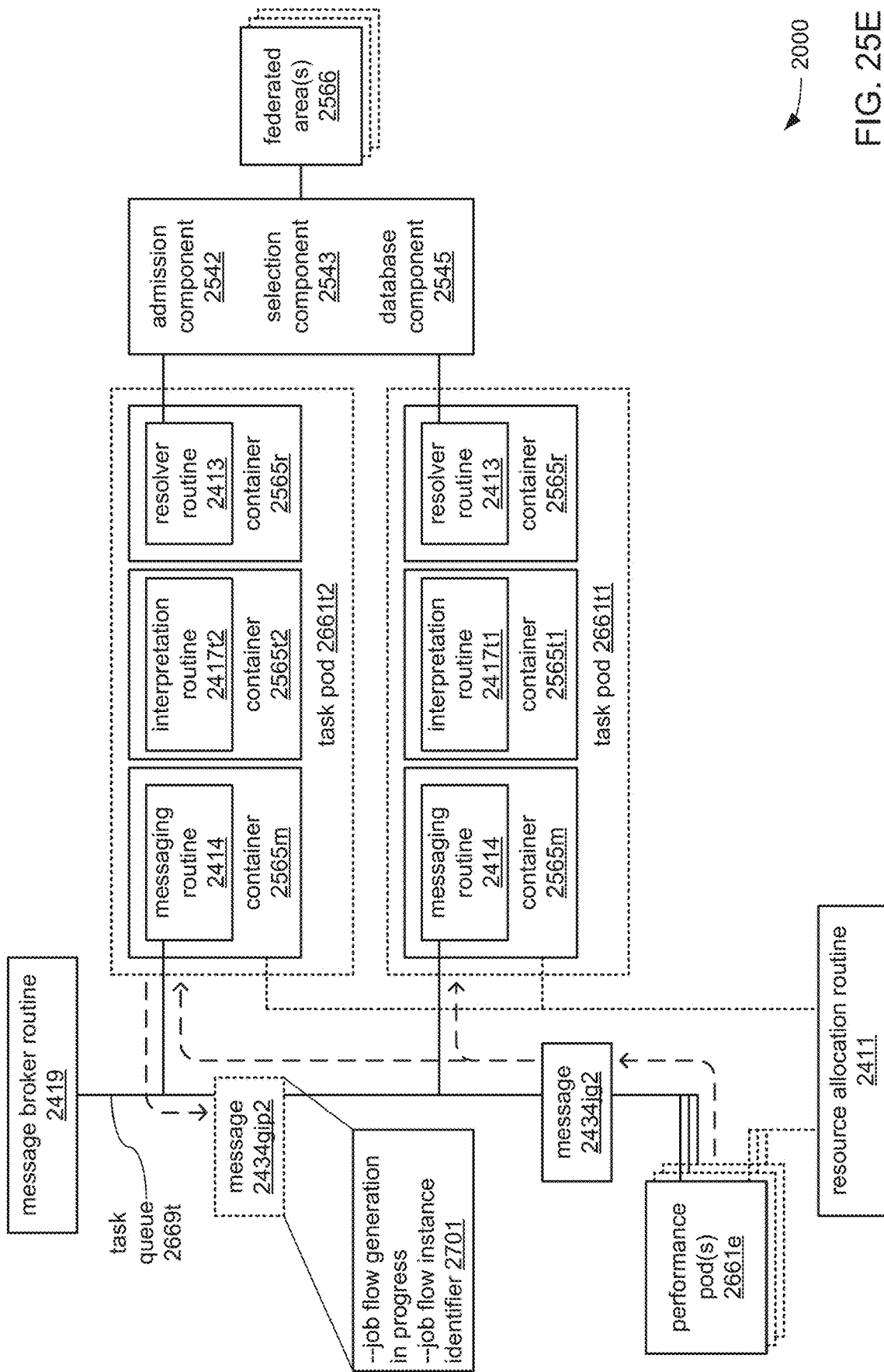

FIG. 25E

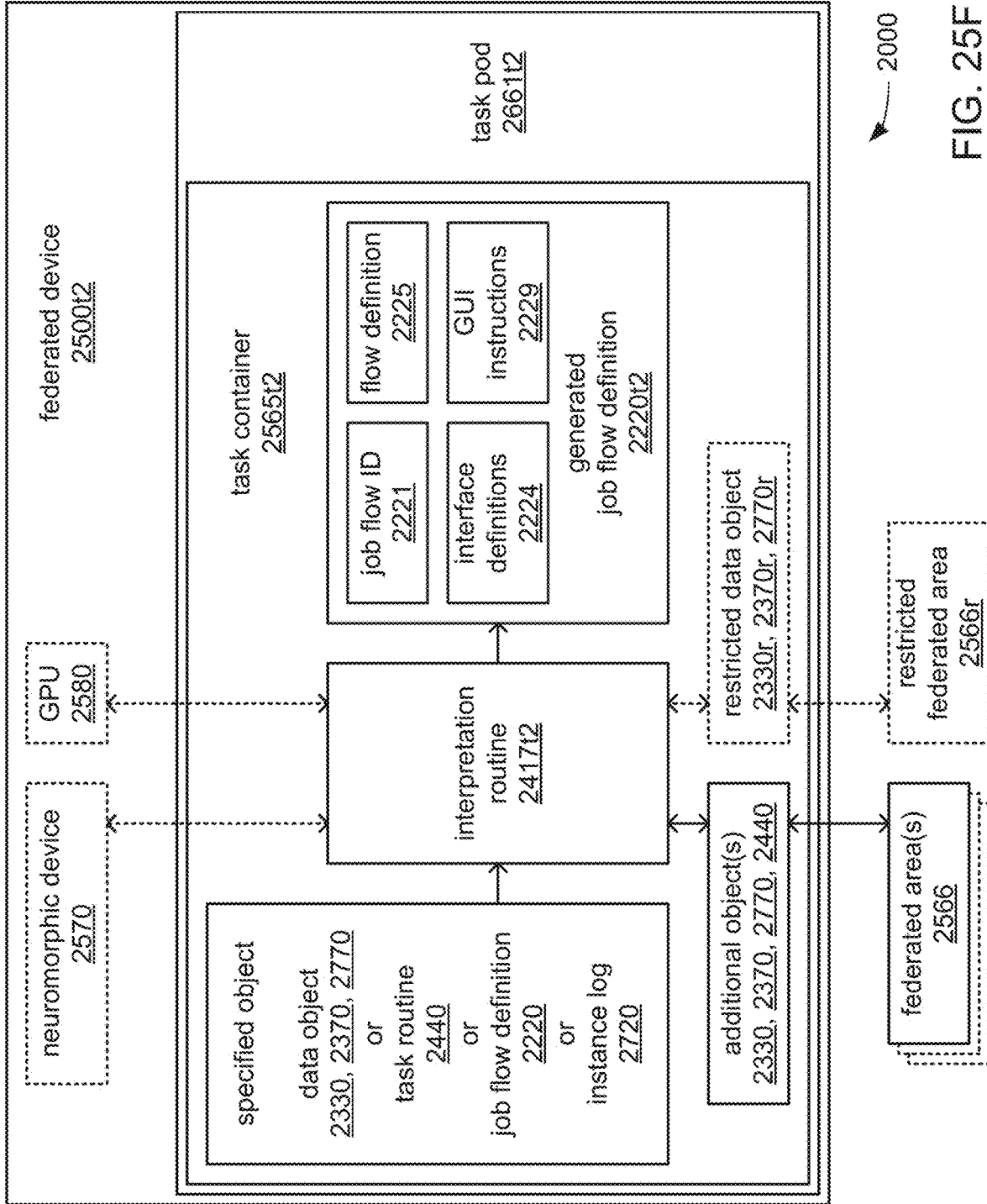
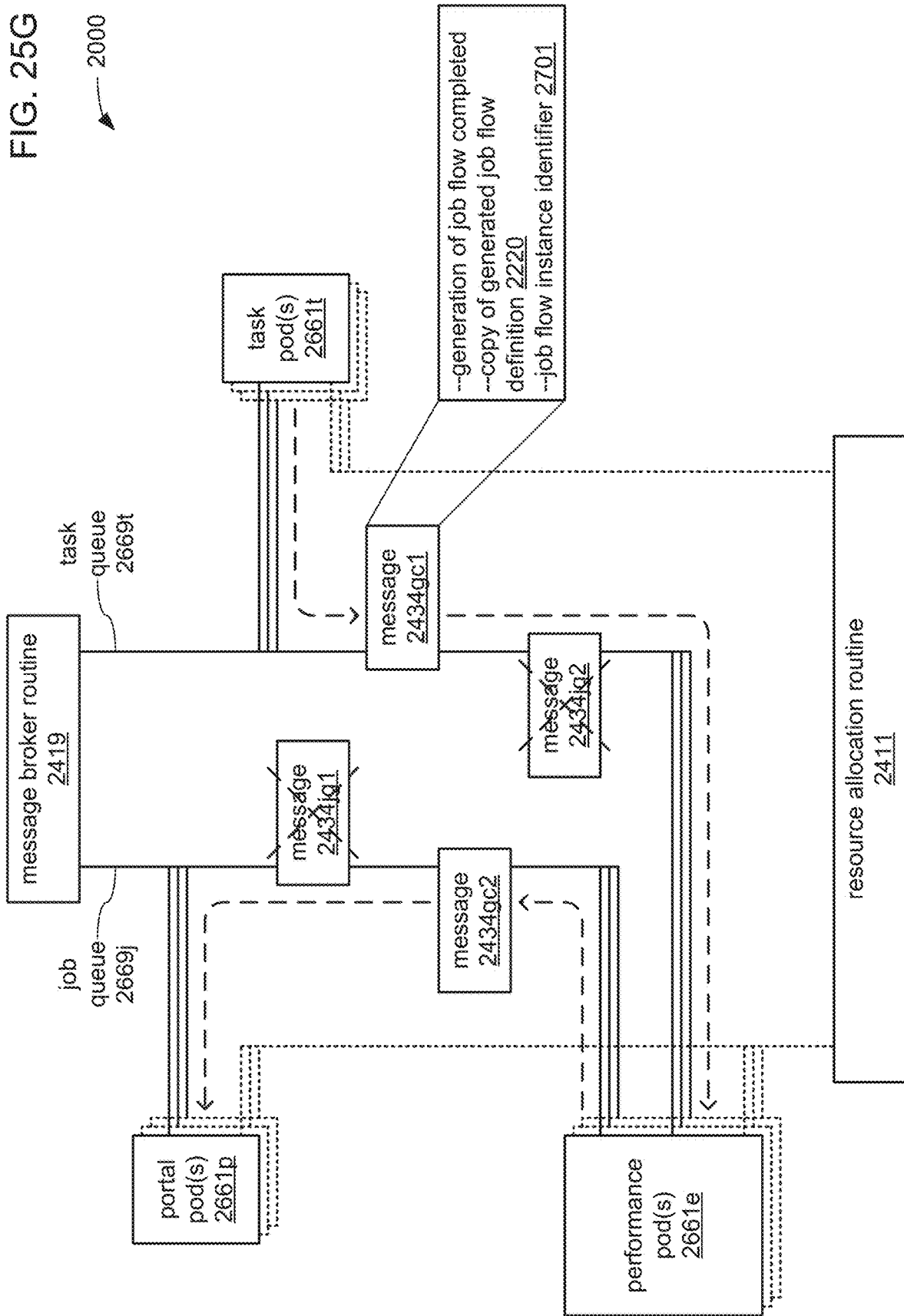

FIG. 25F

FIG. 25G

2000



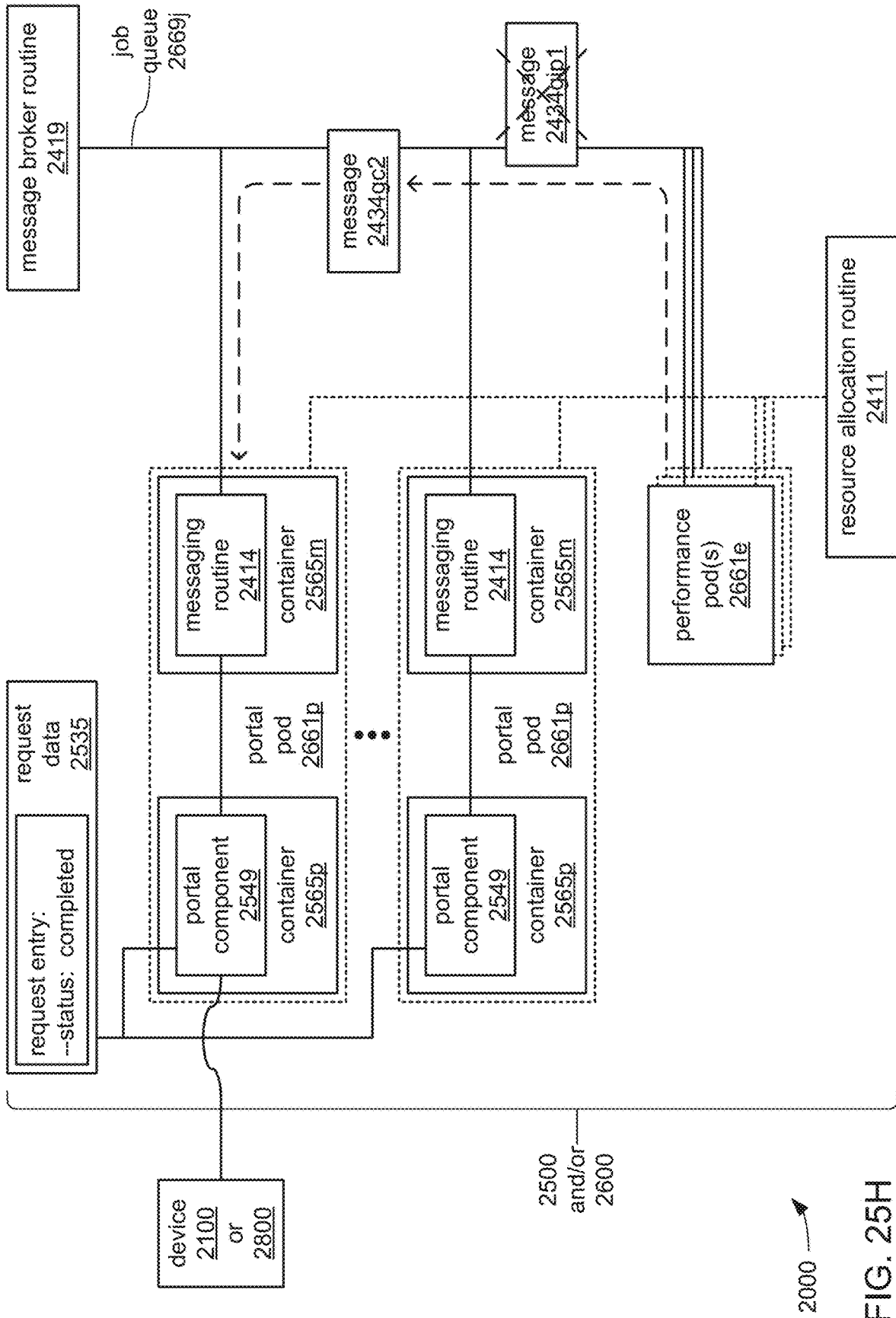
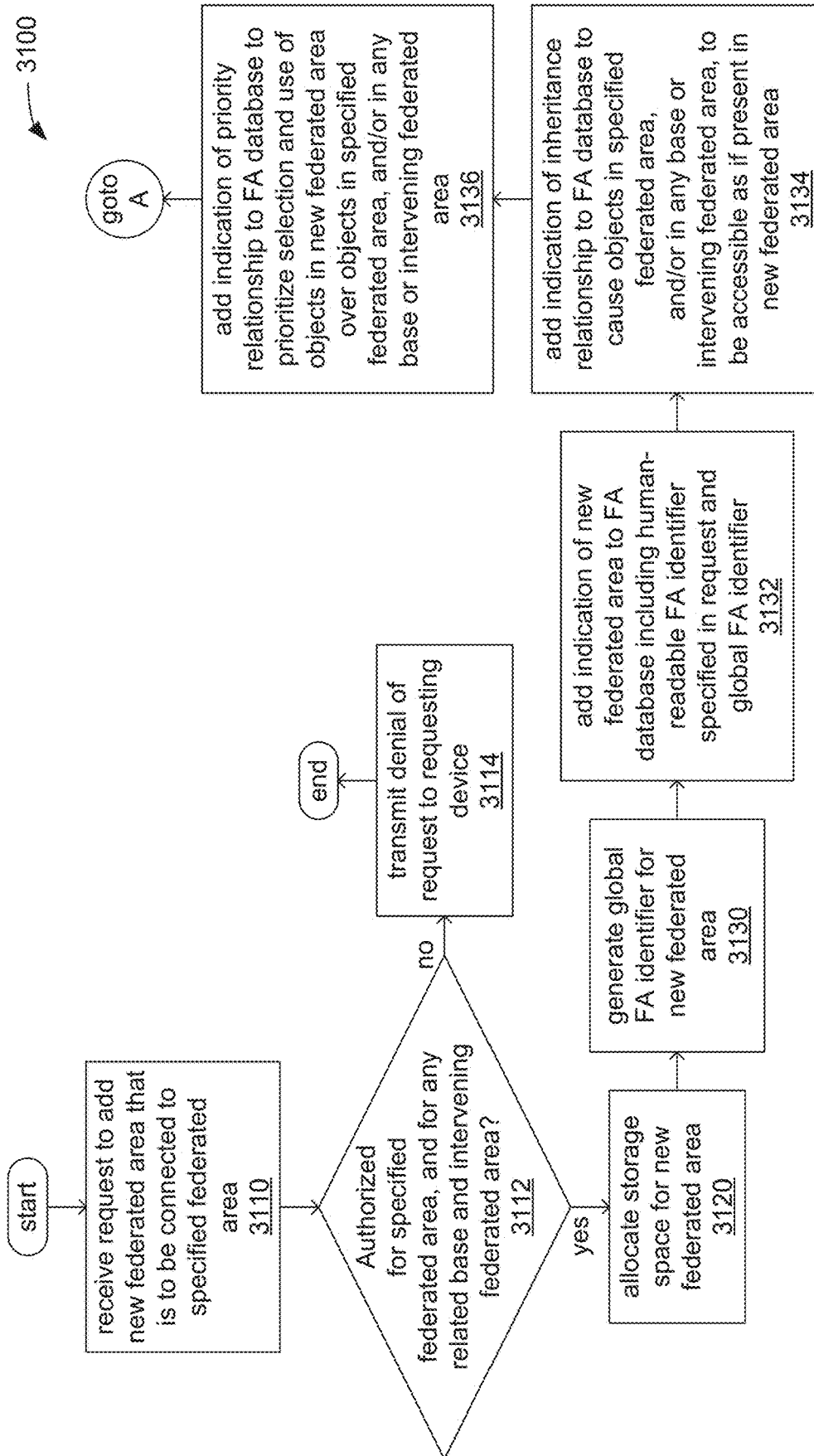
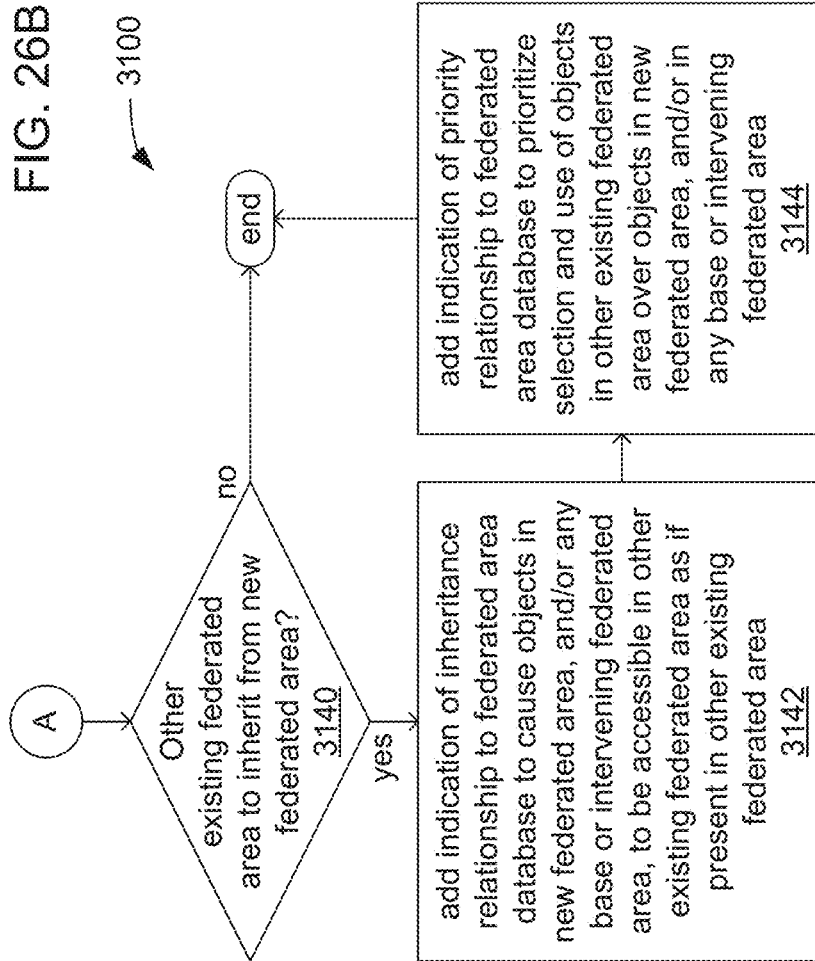
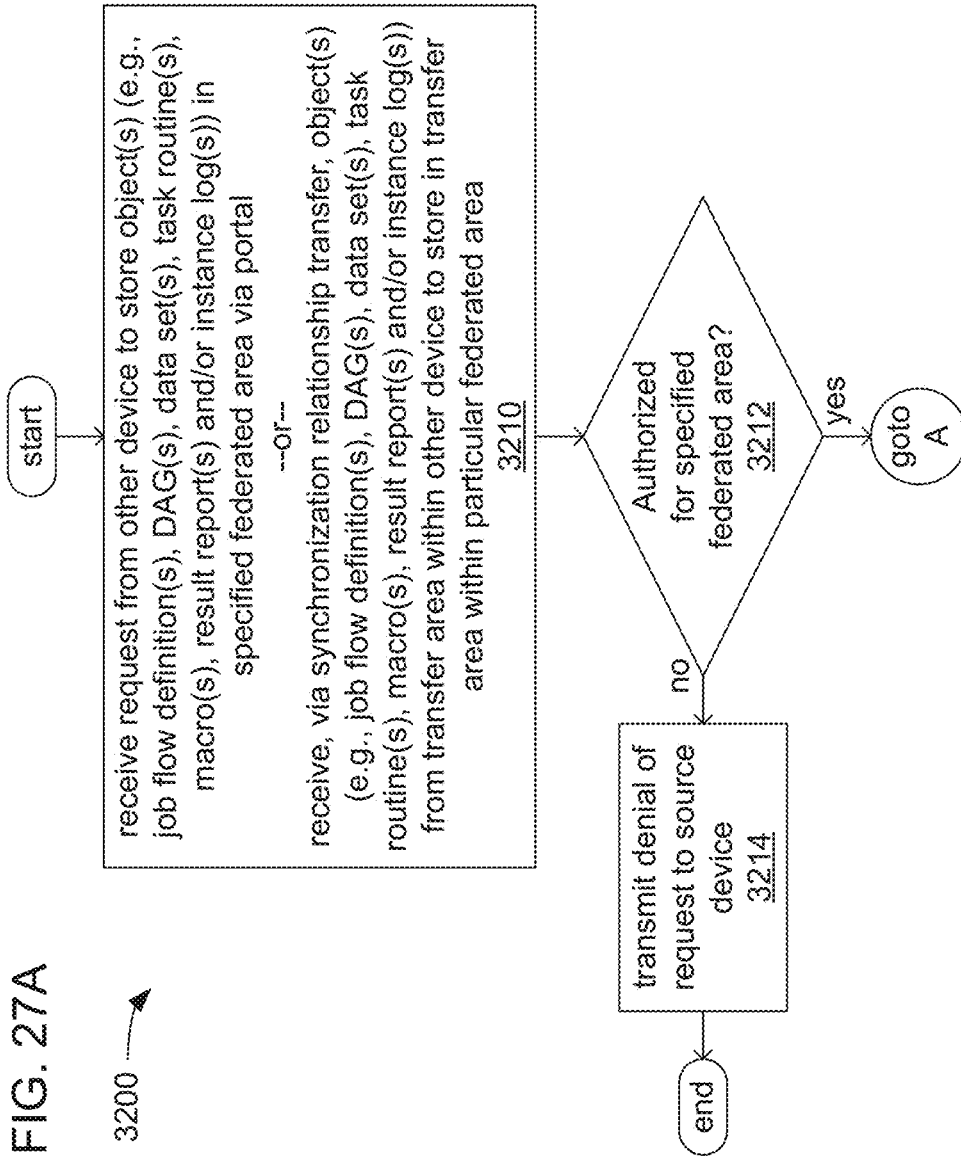

FIG. 25H

FIG. 26A







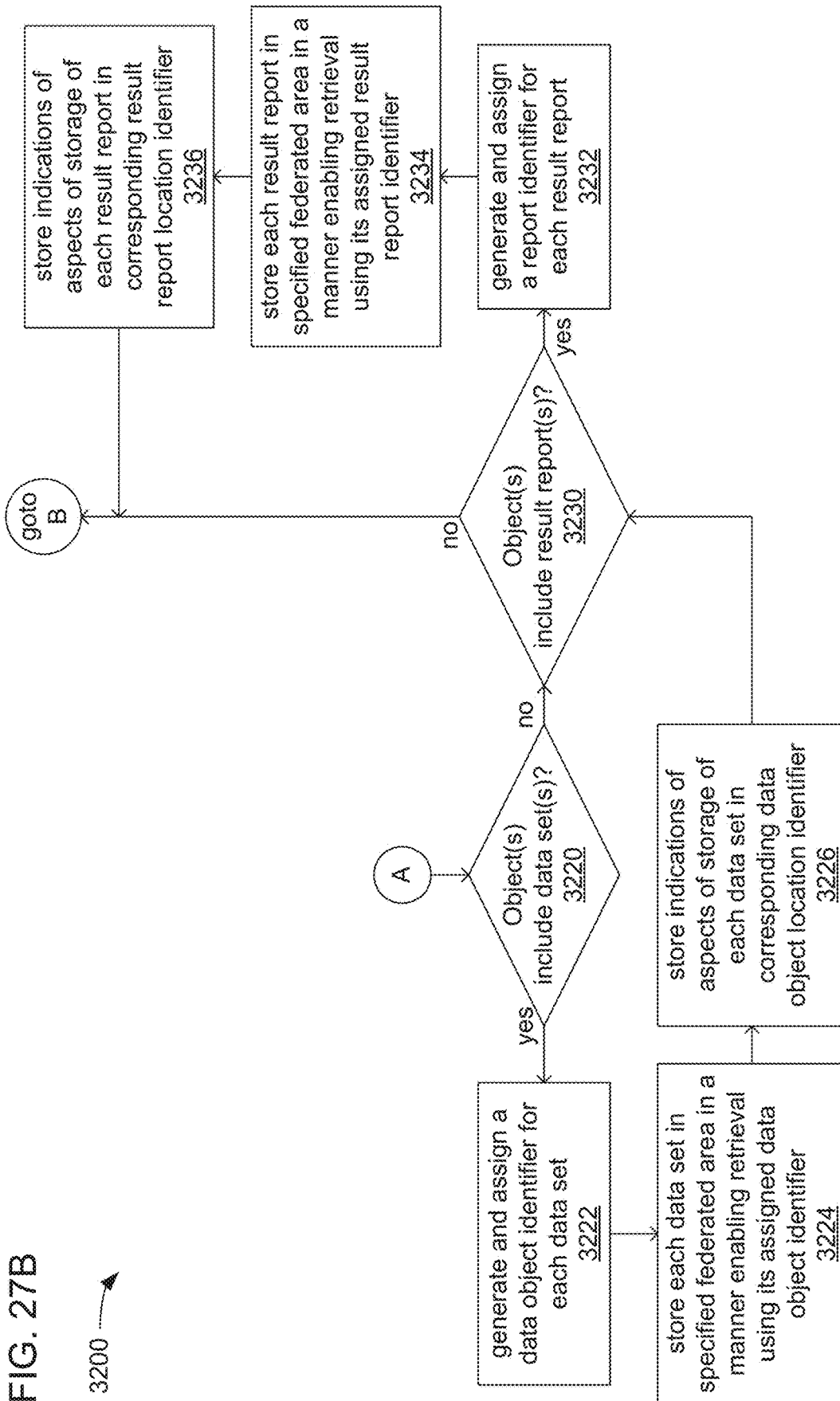

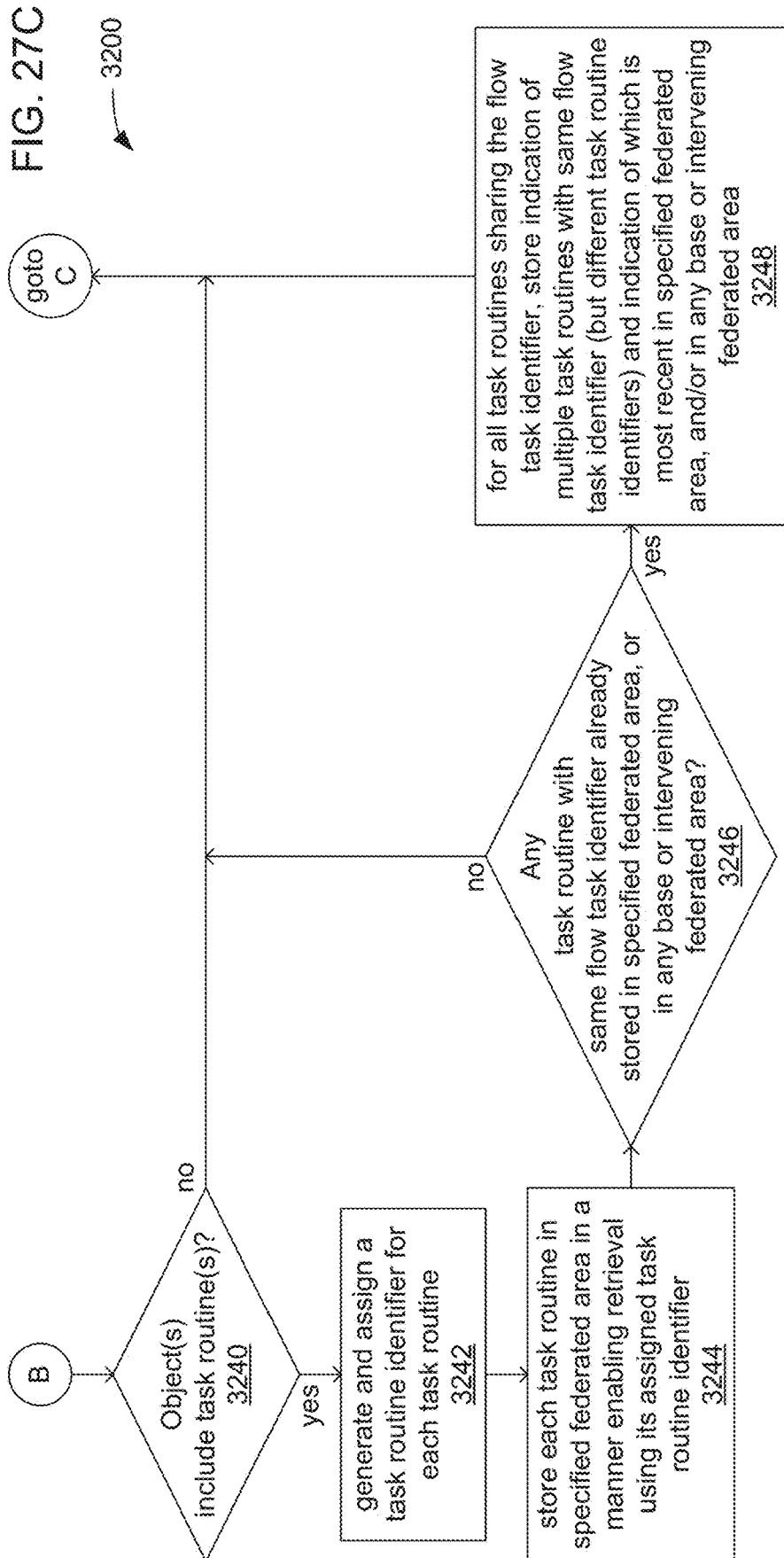

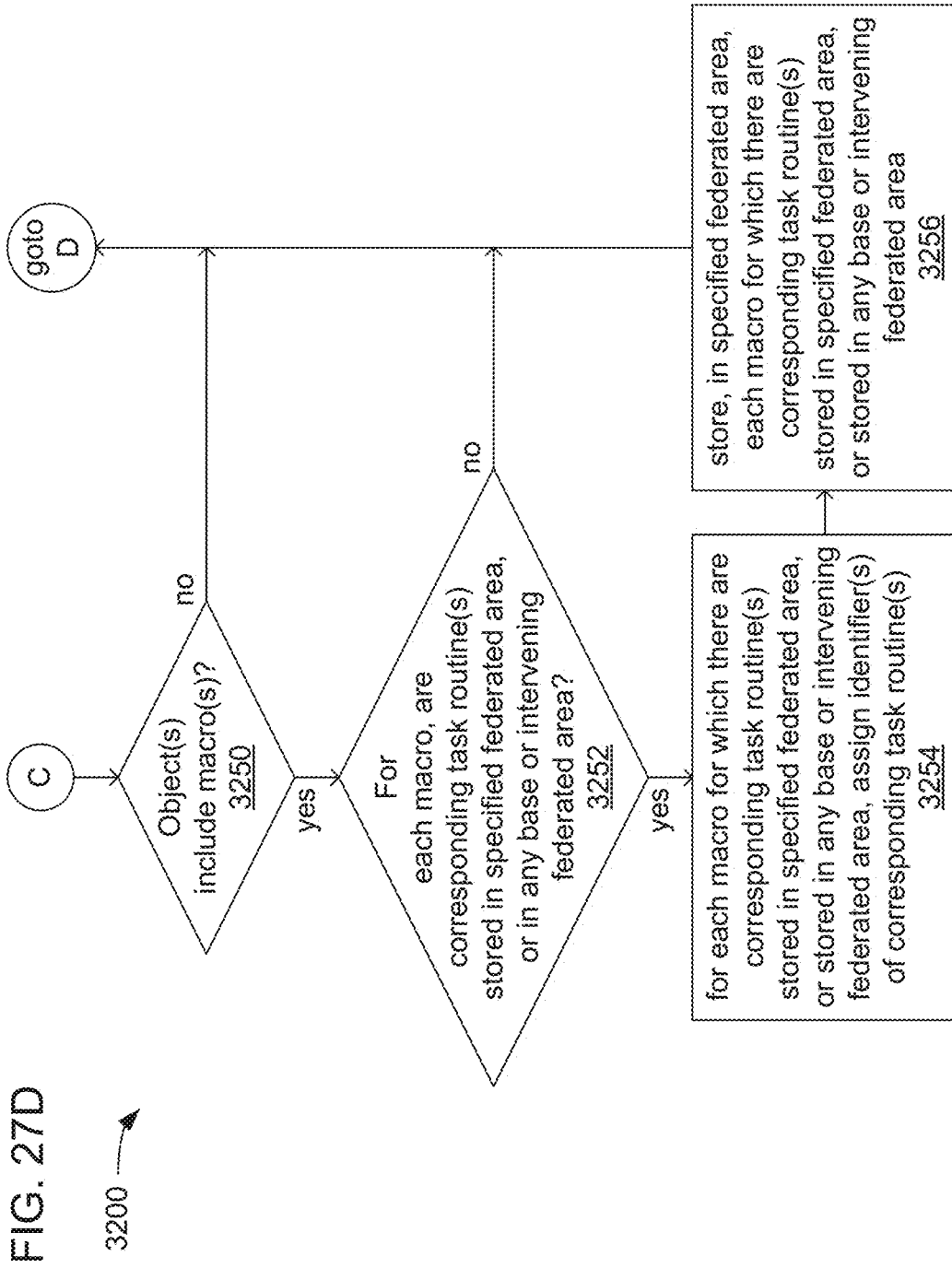

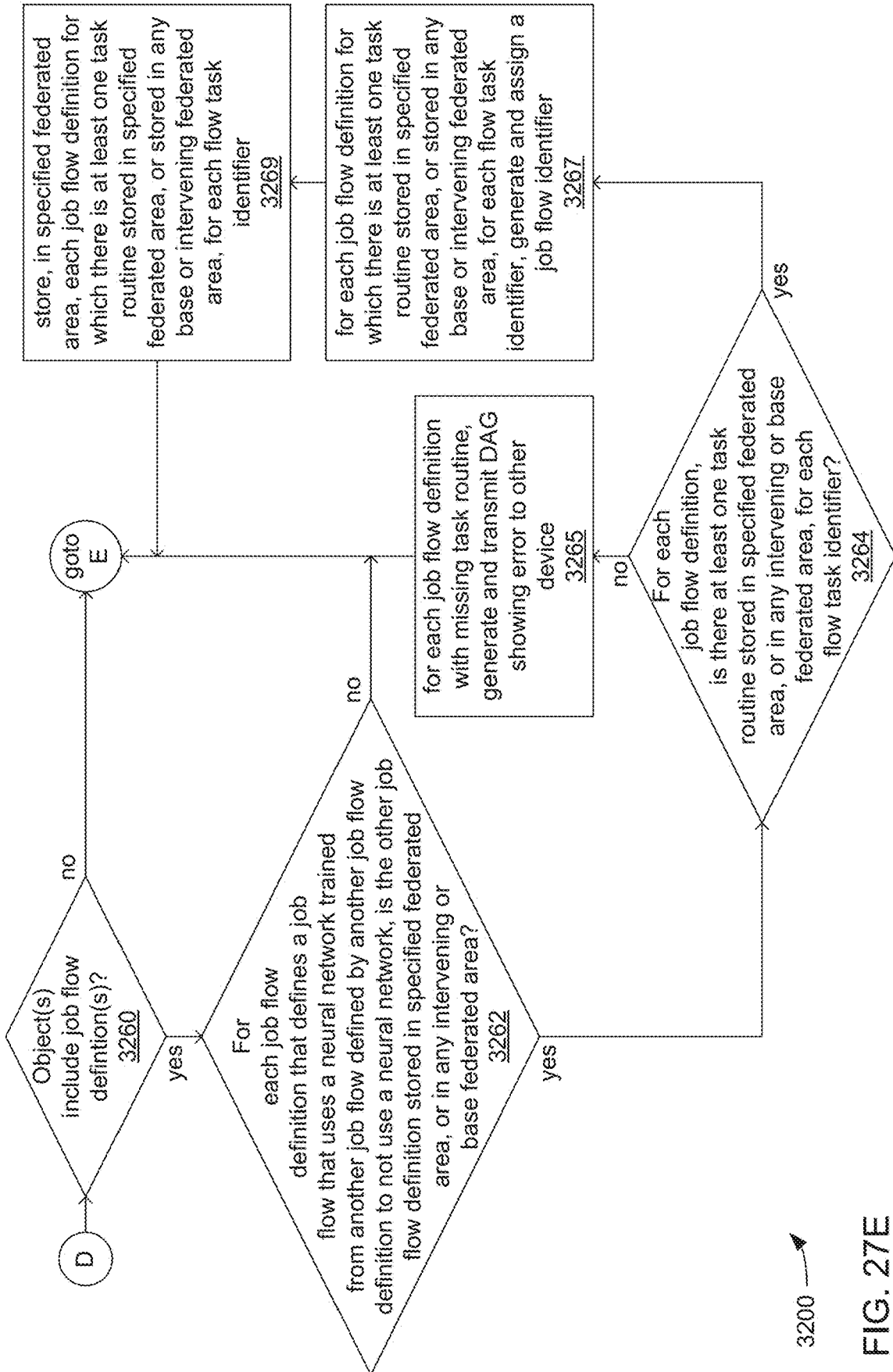

3200 →

FIG. 27E

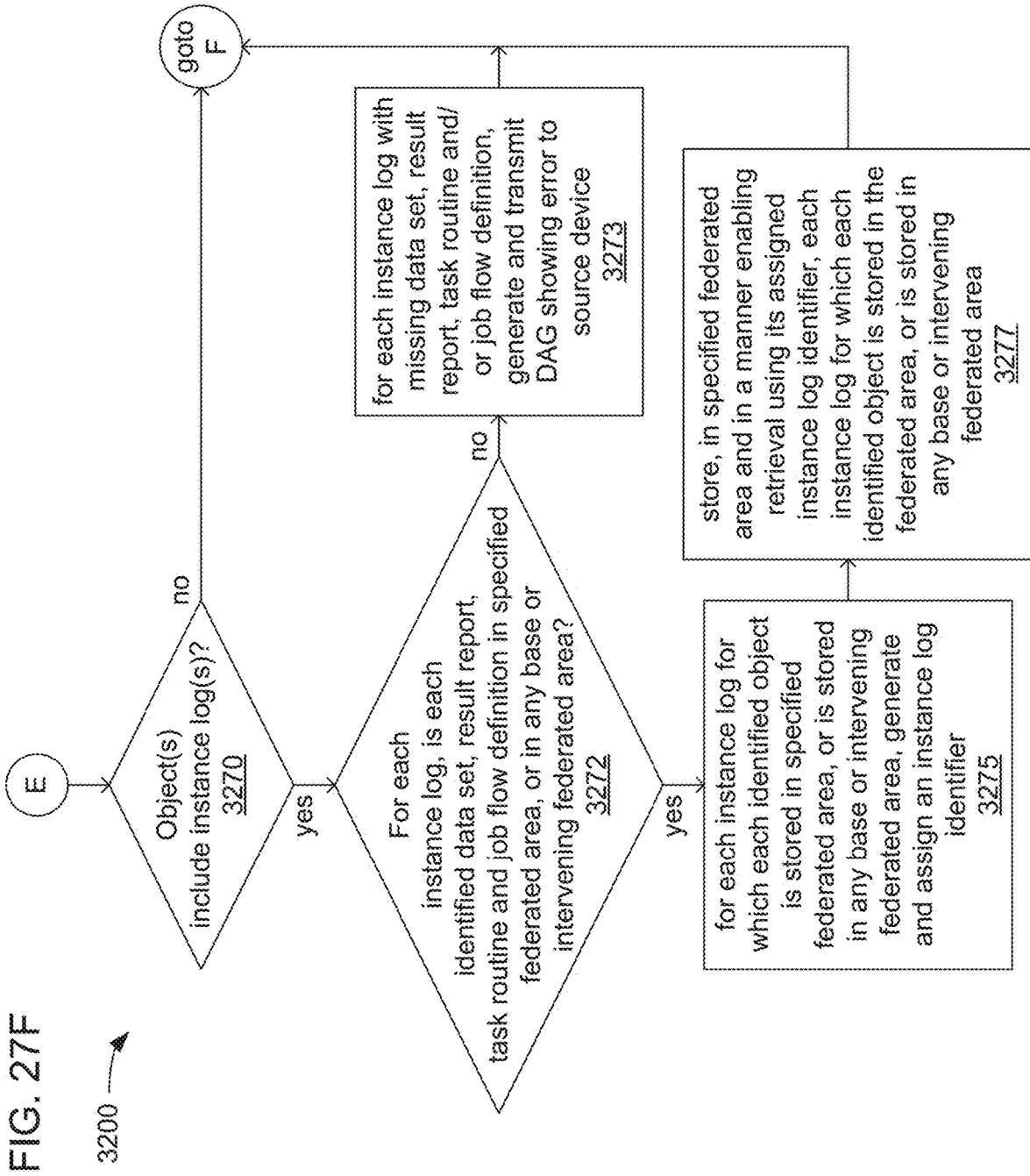

FIG. 27G

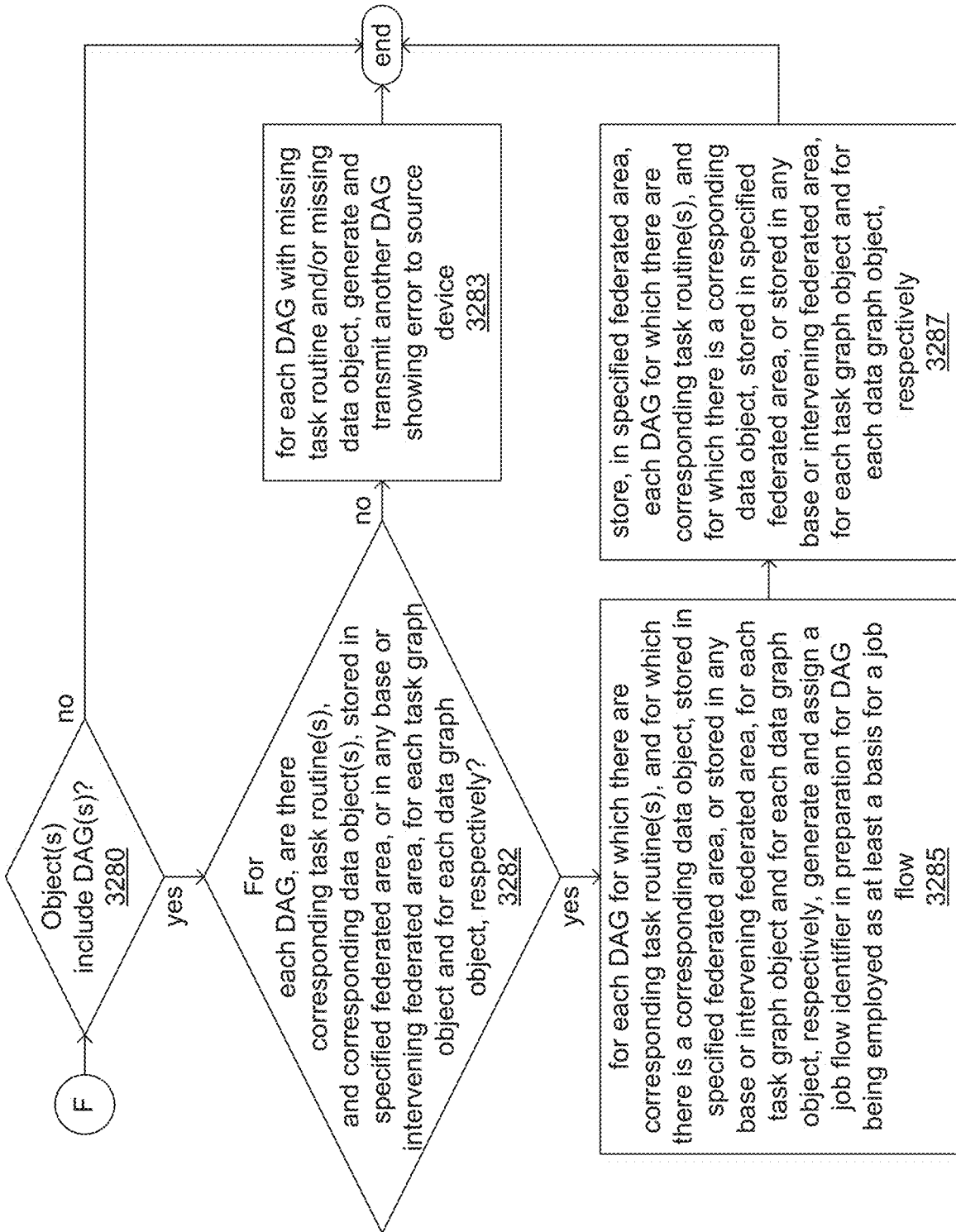

FIG. 28A

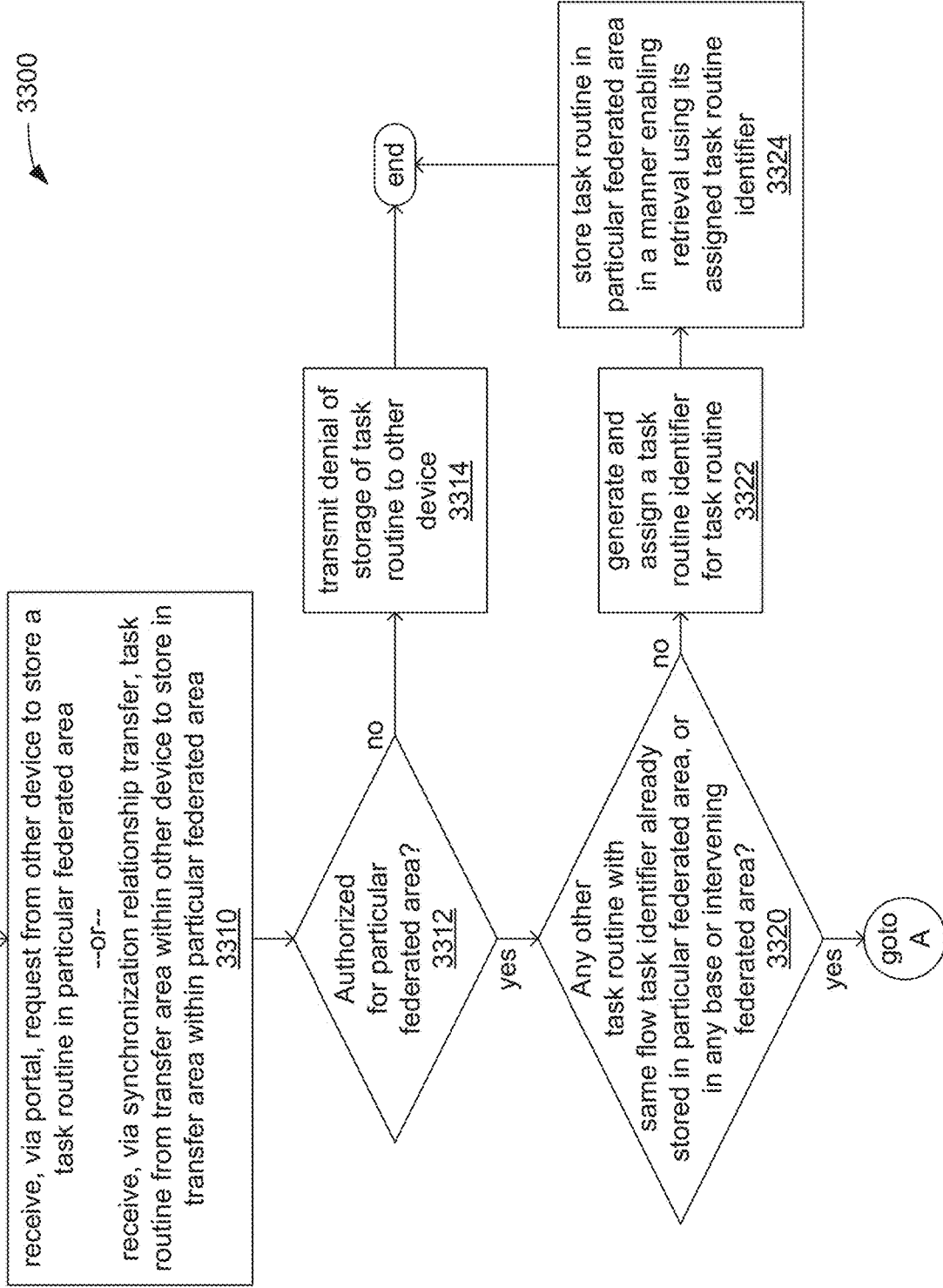

FIG. 28B

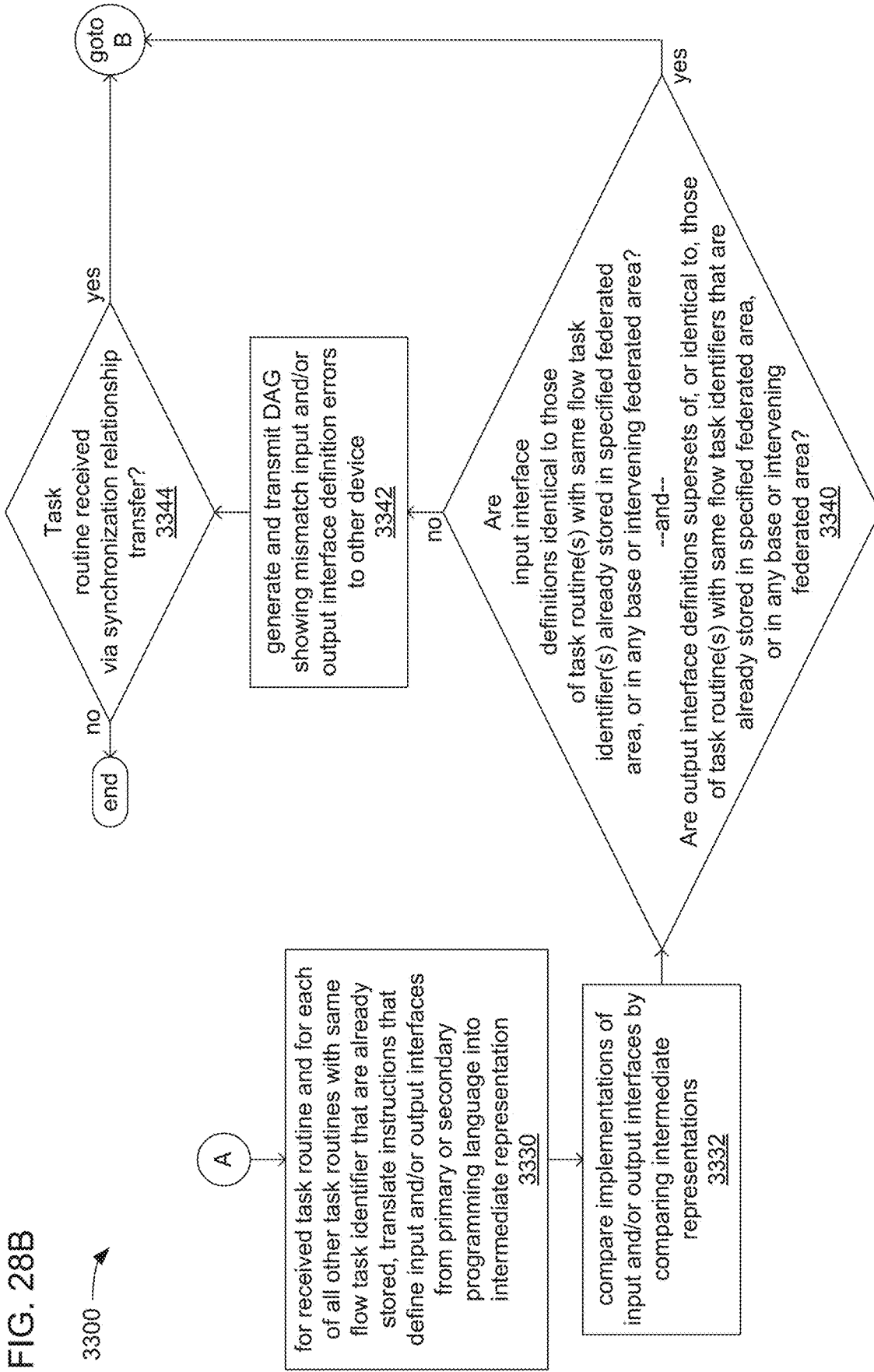

FIG. 28C

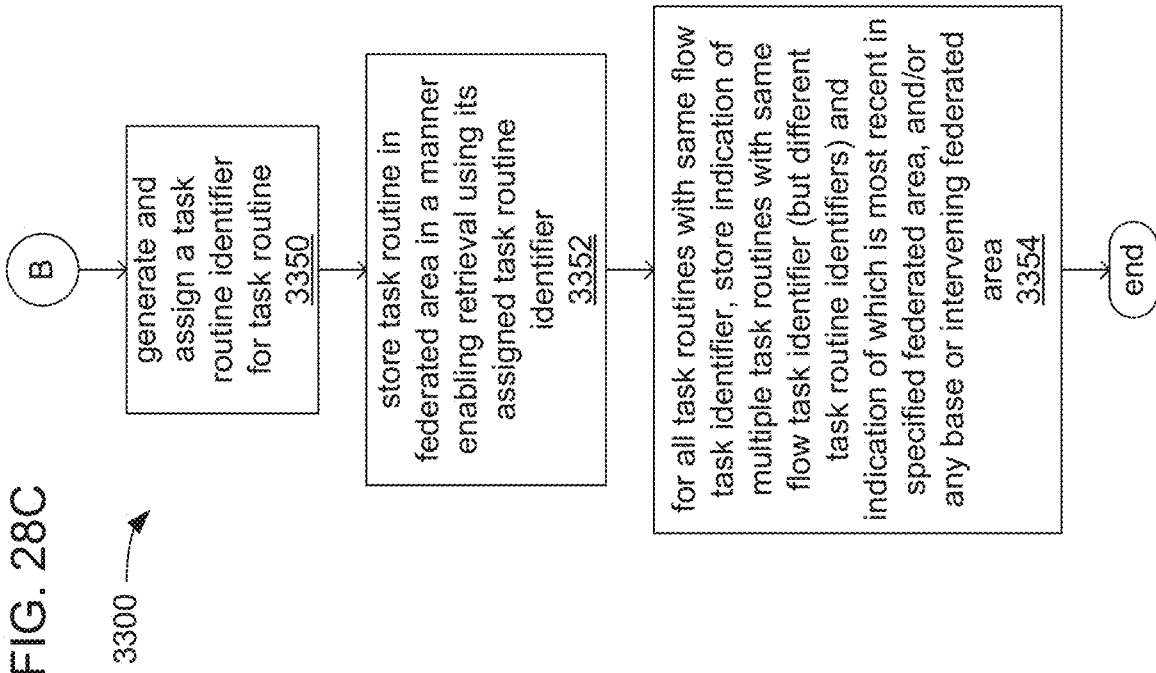
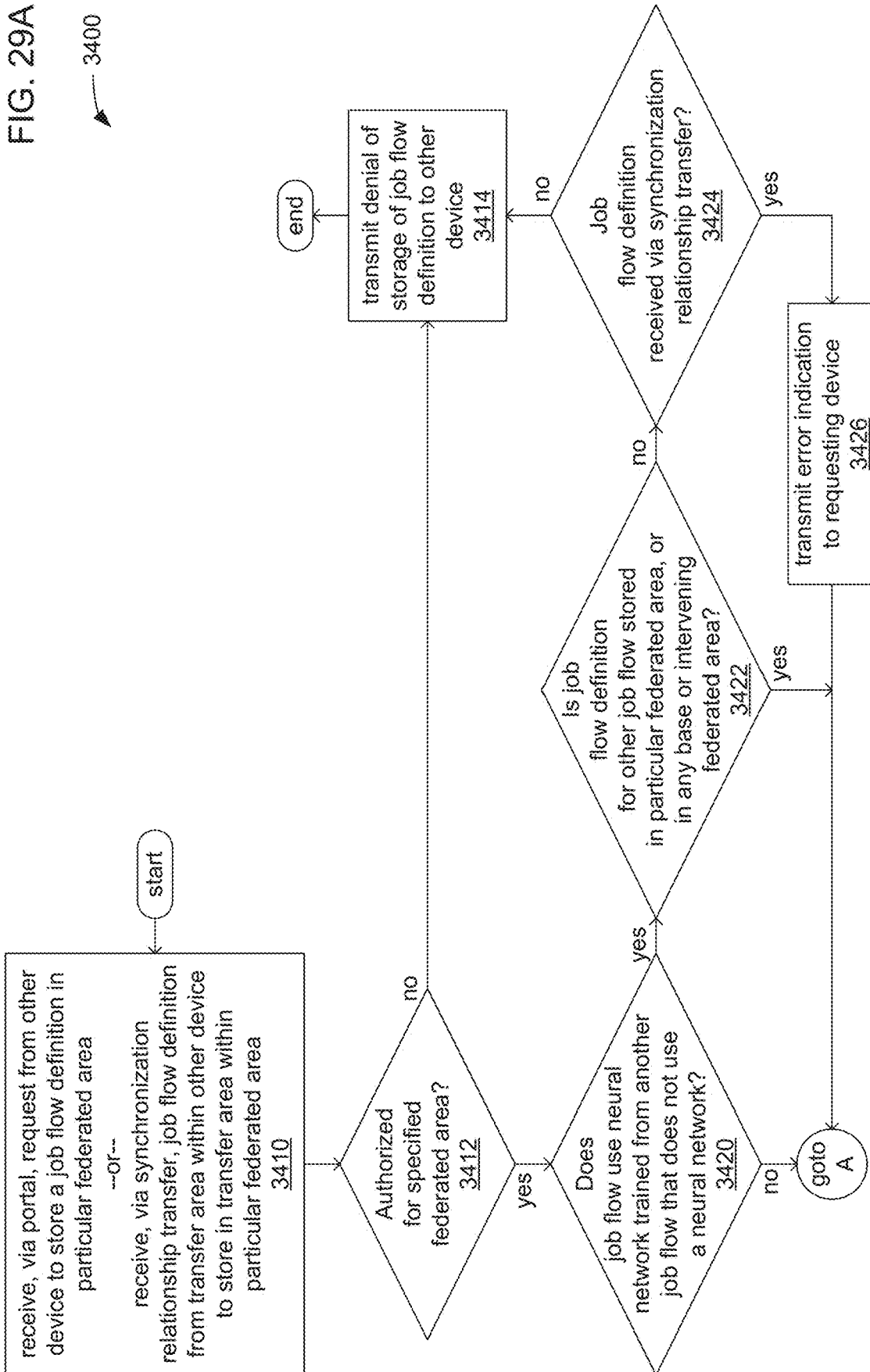

FIG. 29A

3400



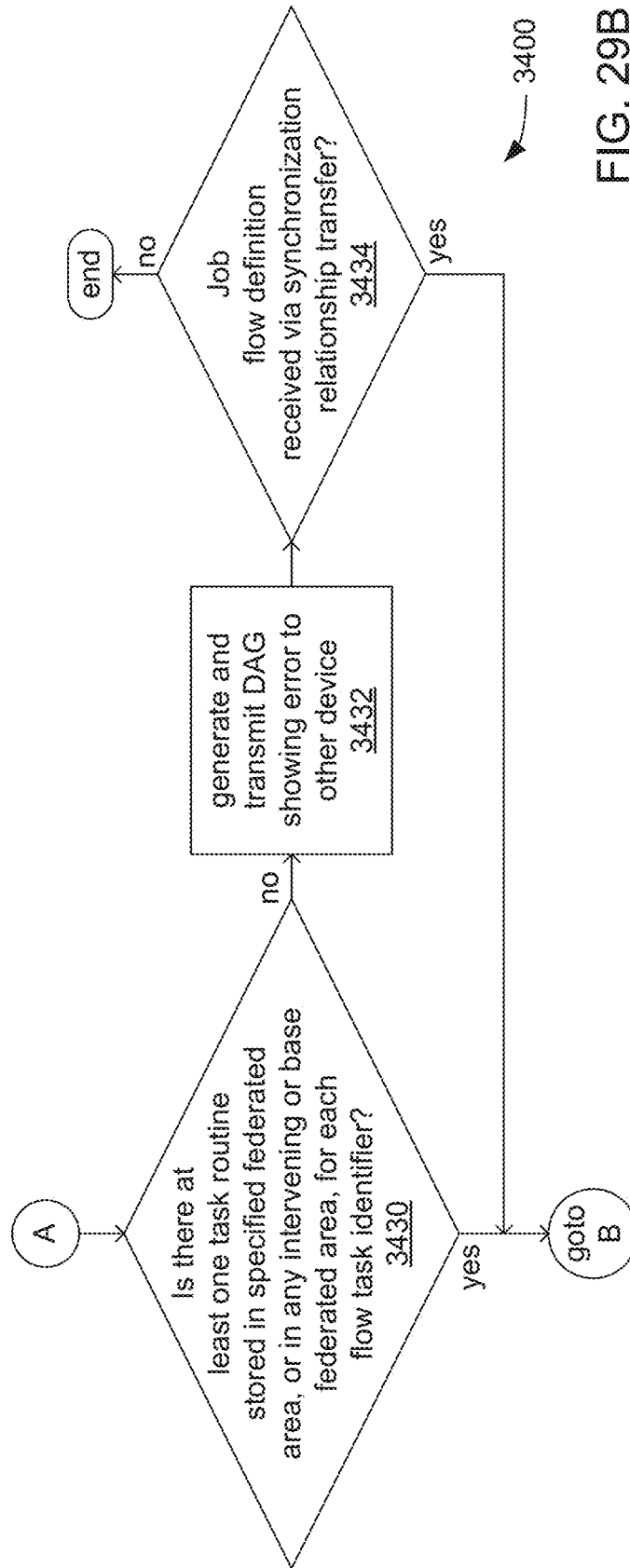
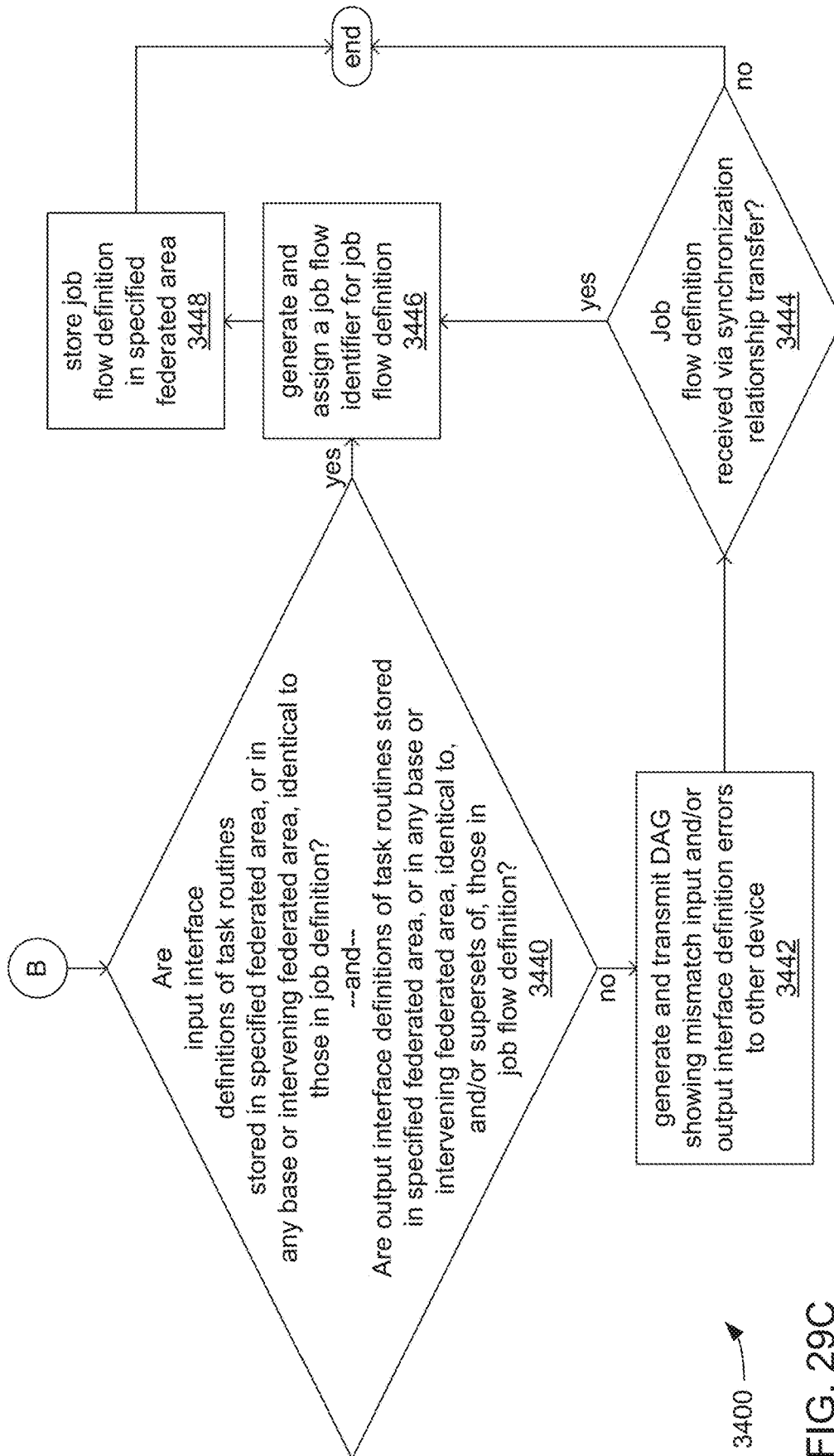
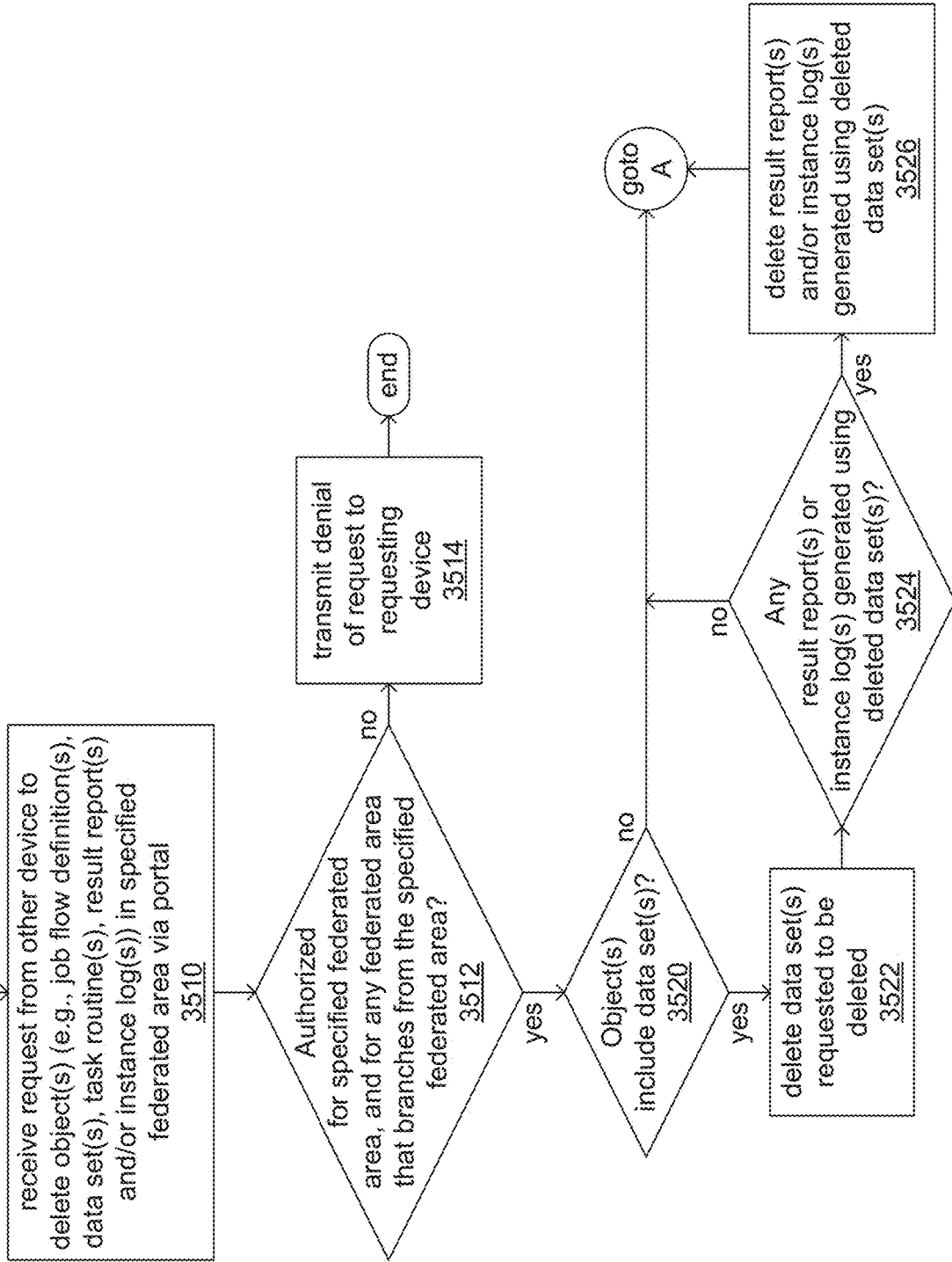

FIG. 29B



3400 →
FIG. 29C

FIG. 30A



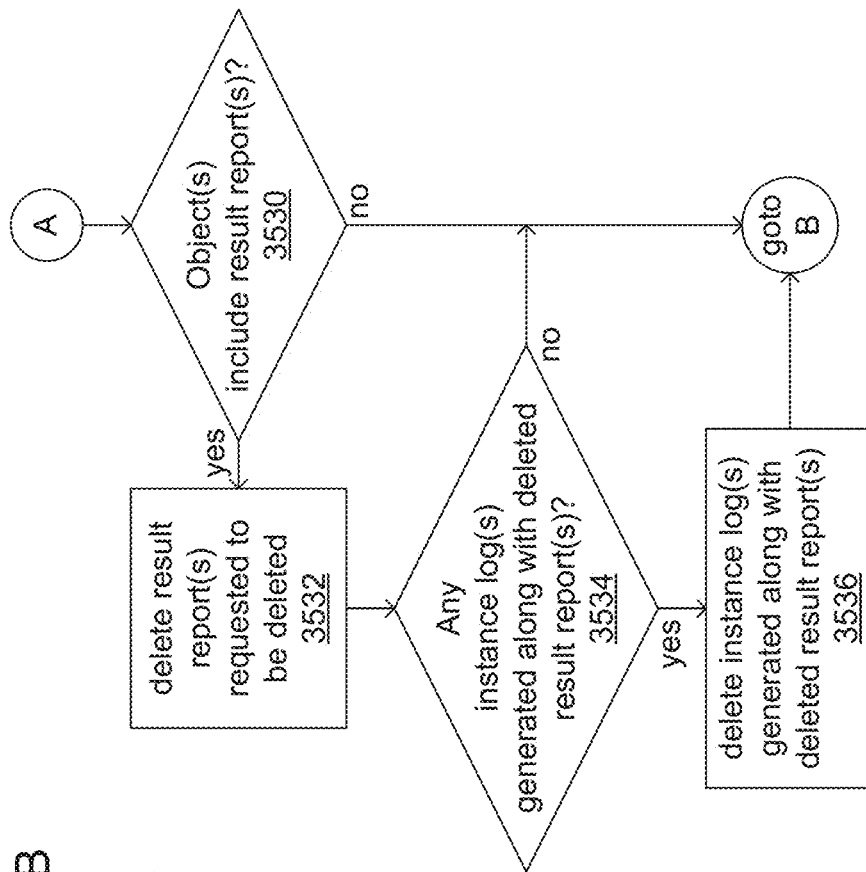
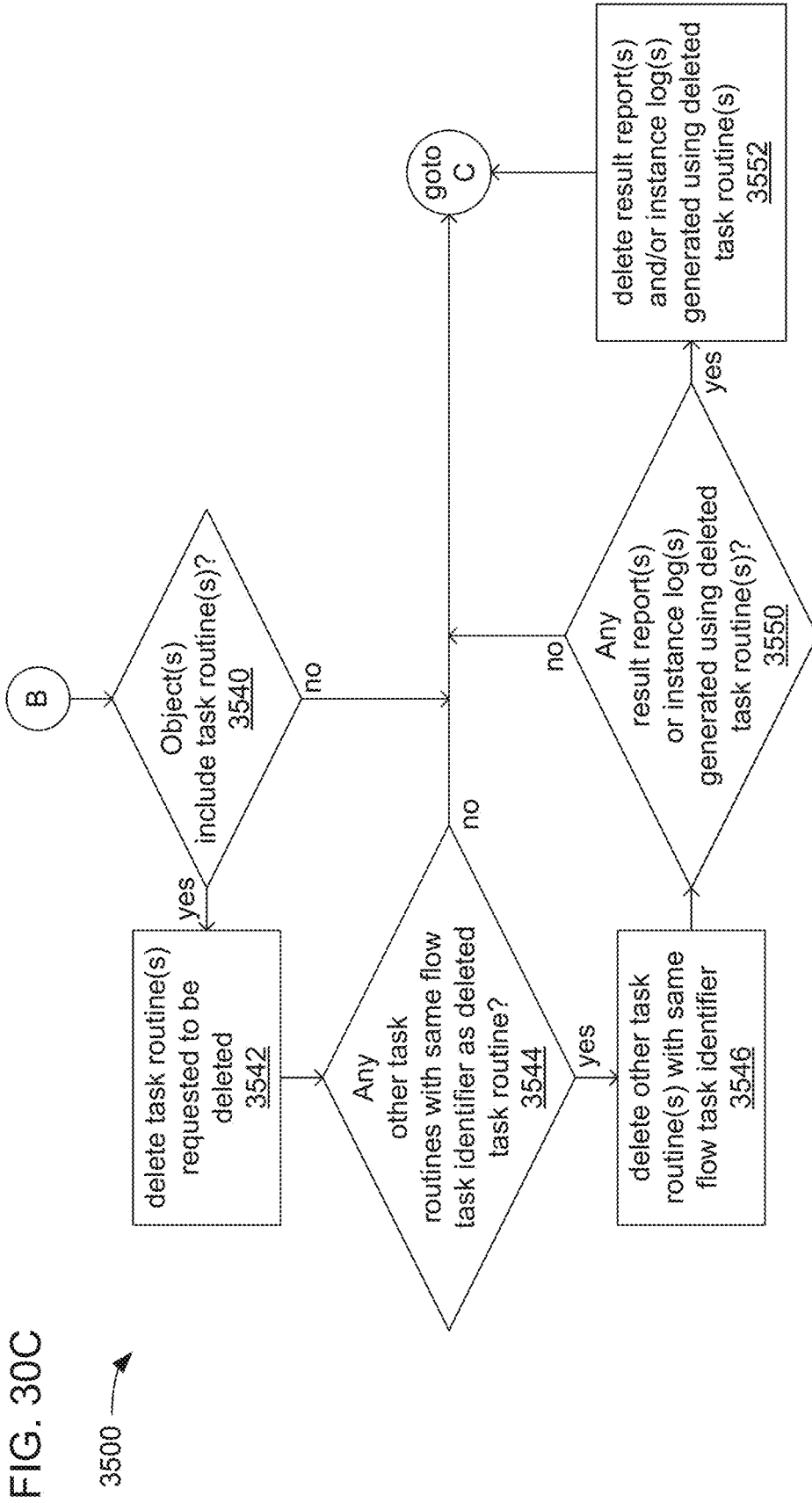

FIG. 30B

3500 →



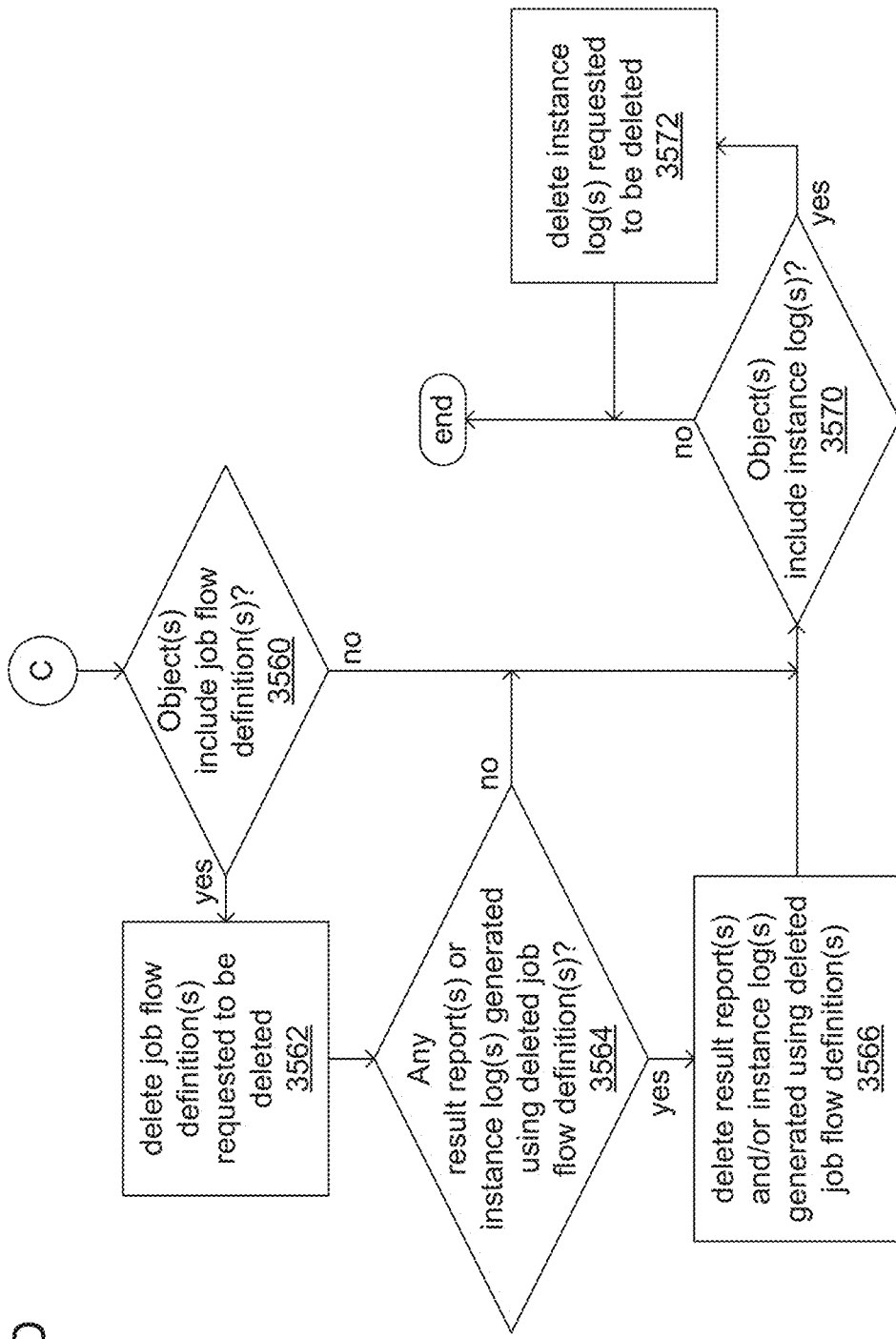

FIG. 30D

3500

FIG. 31A

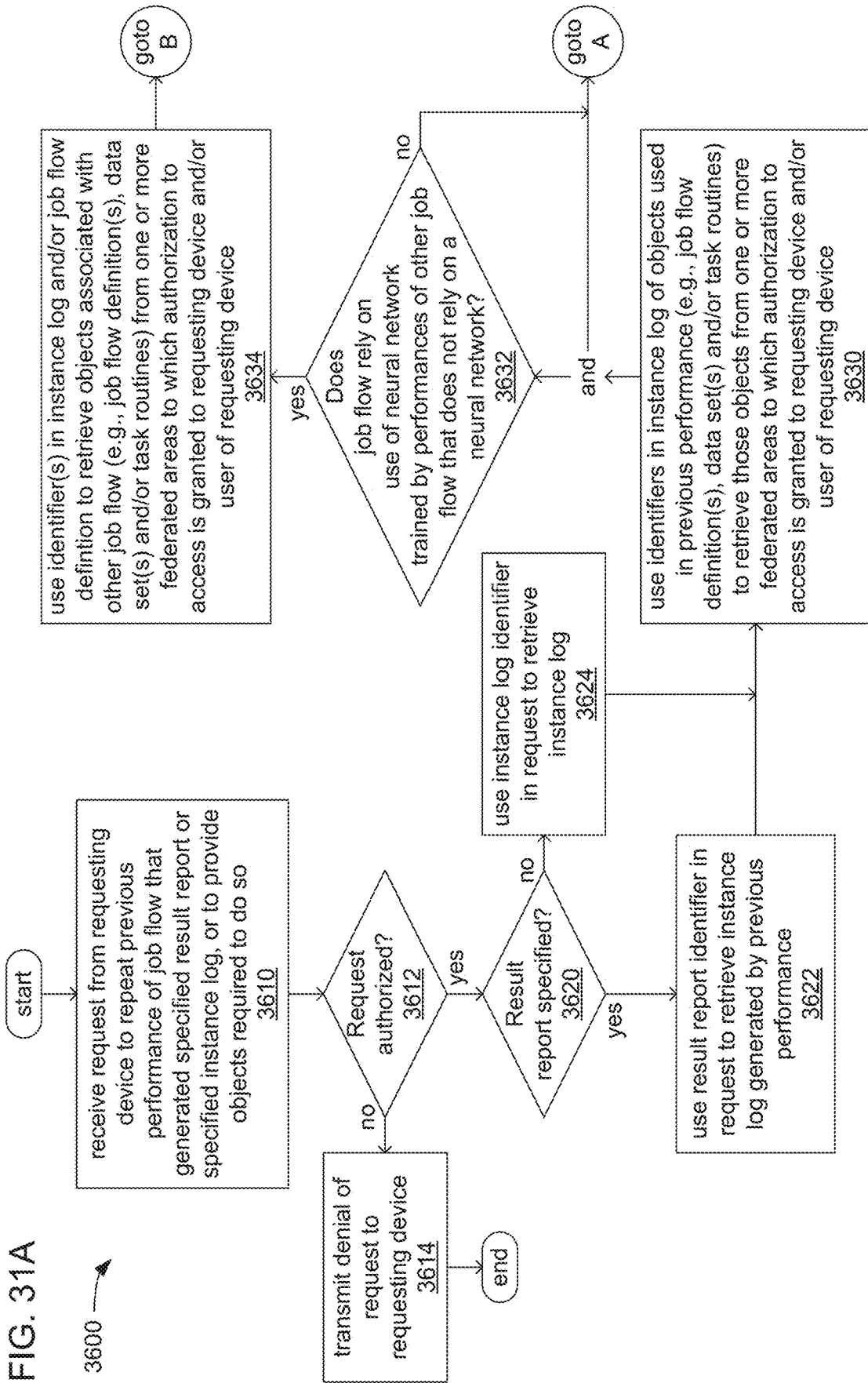
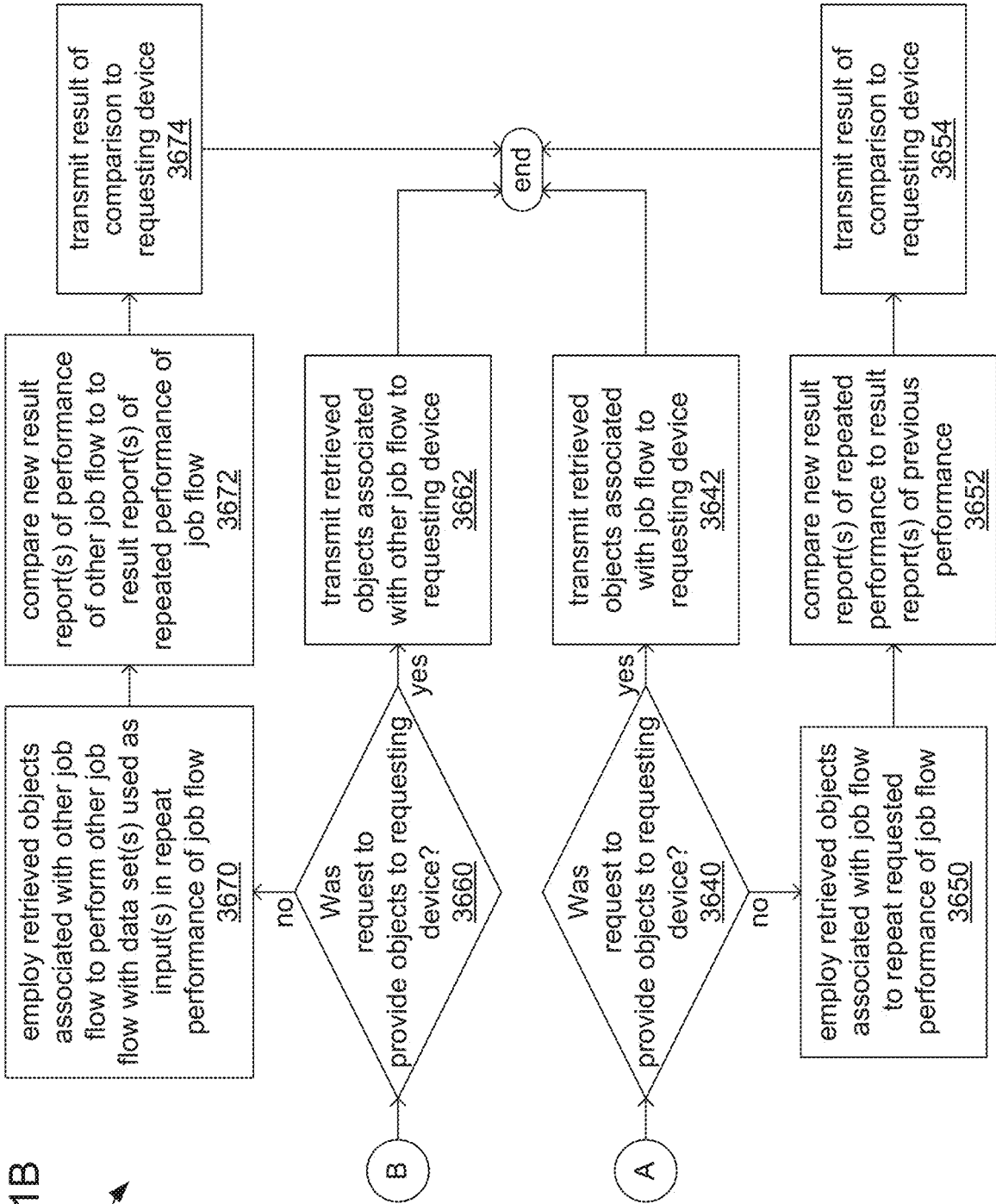
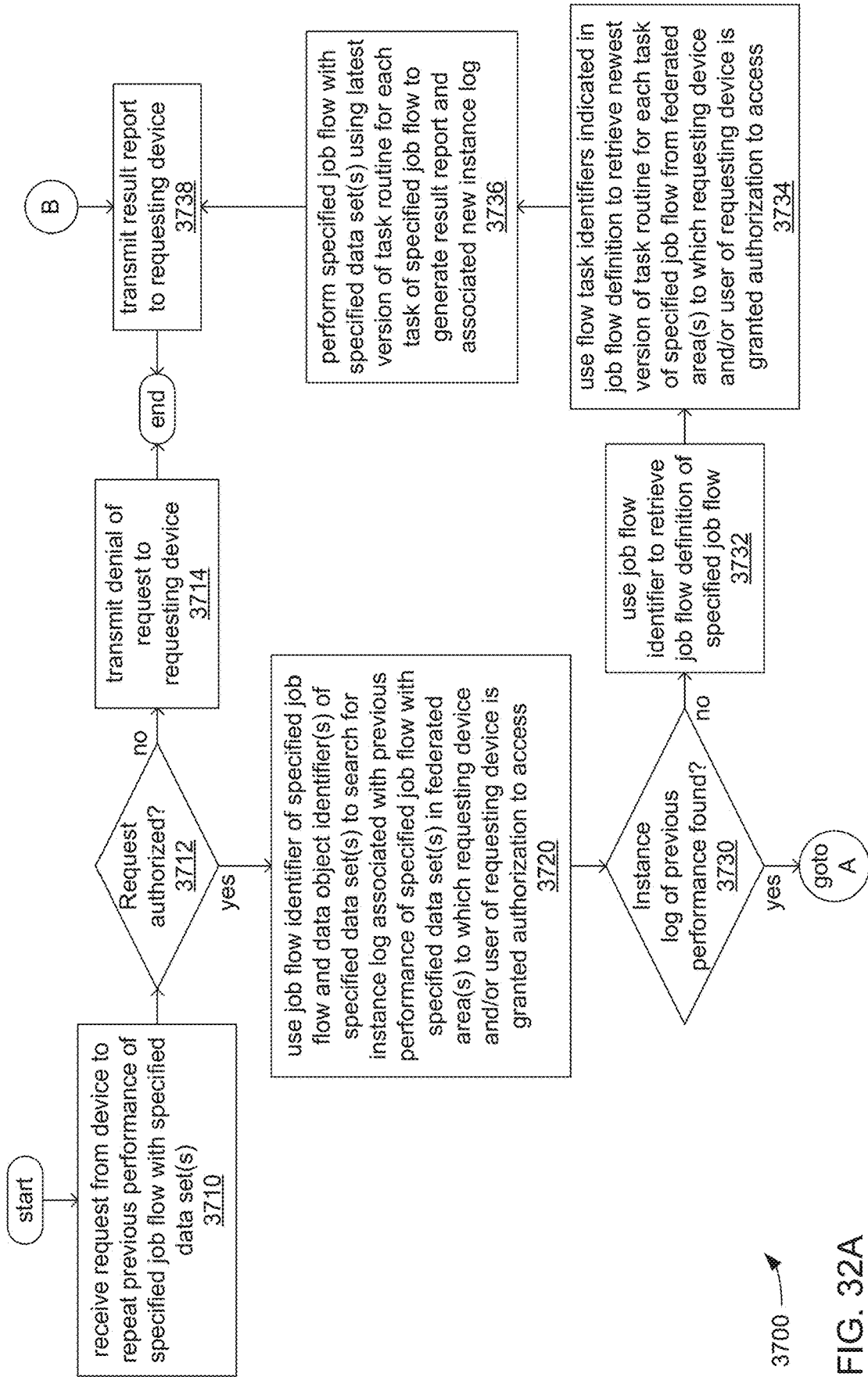

FIG. 31B





3700 →

FIG. 32A

FIG. 32B

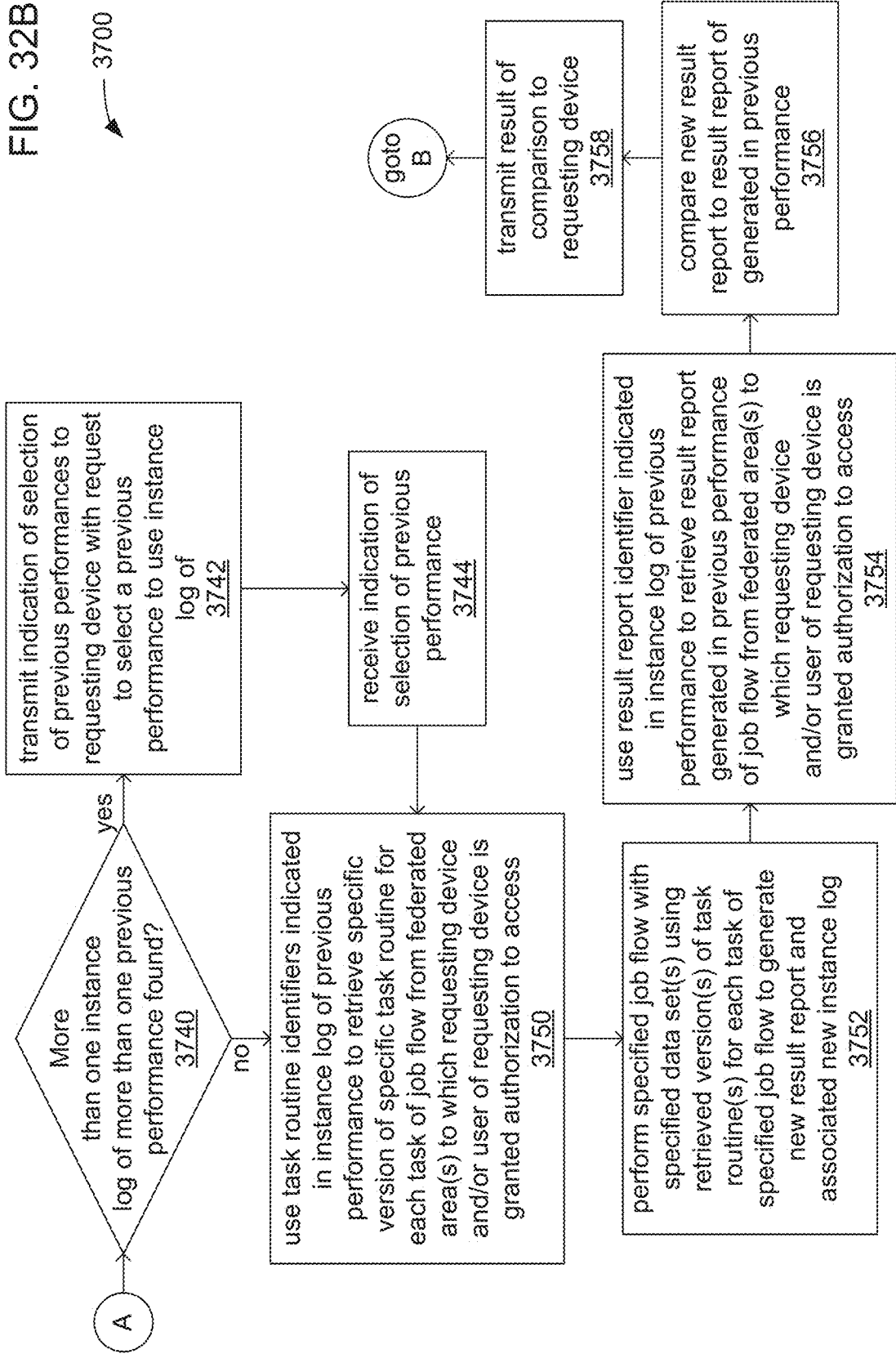
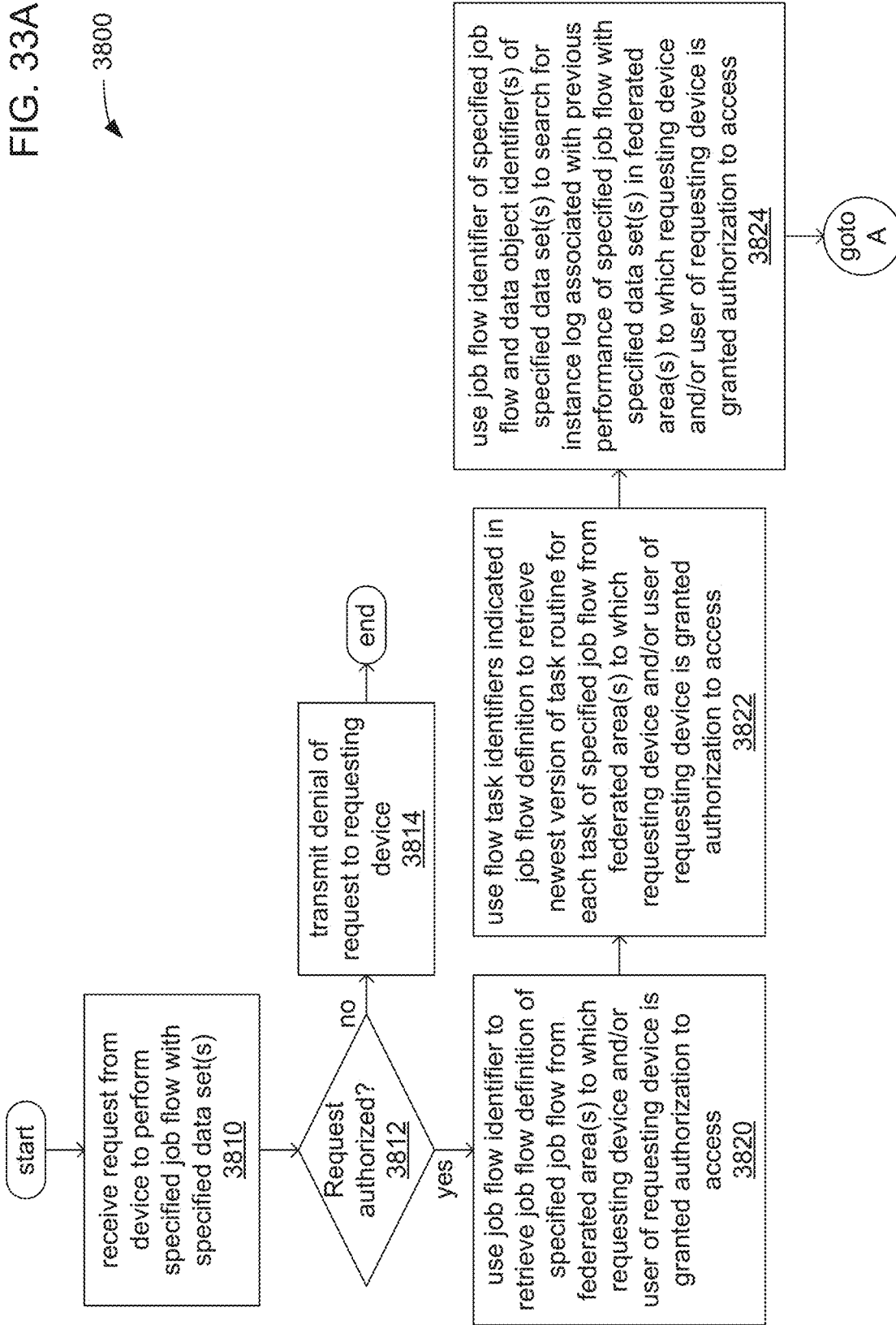

FIG. 33A



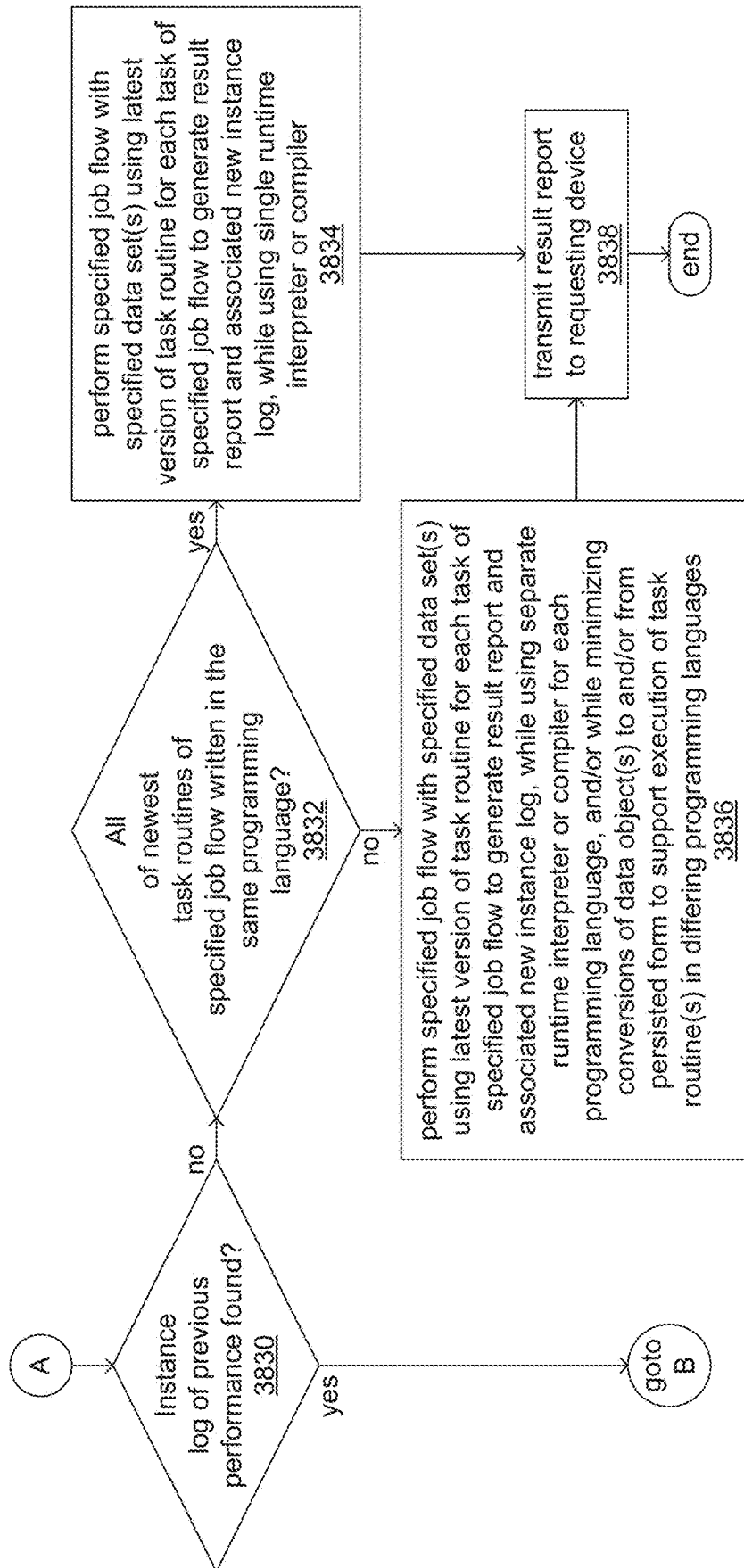

FIG. 33B

3800

FIG. 33C

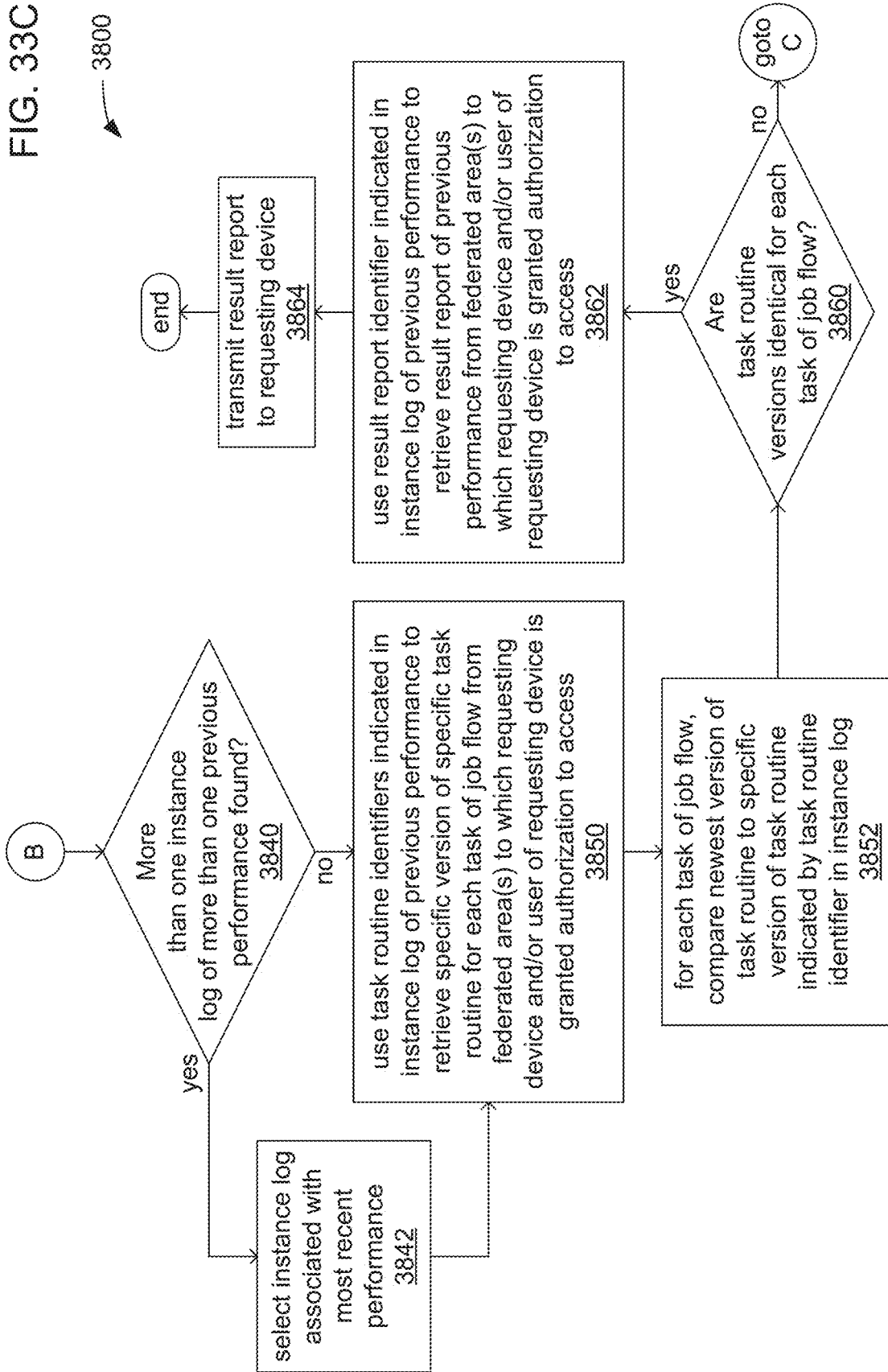

FIG. 33D

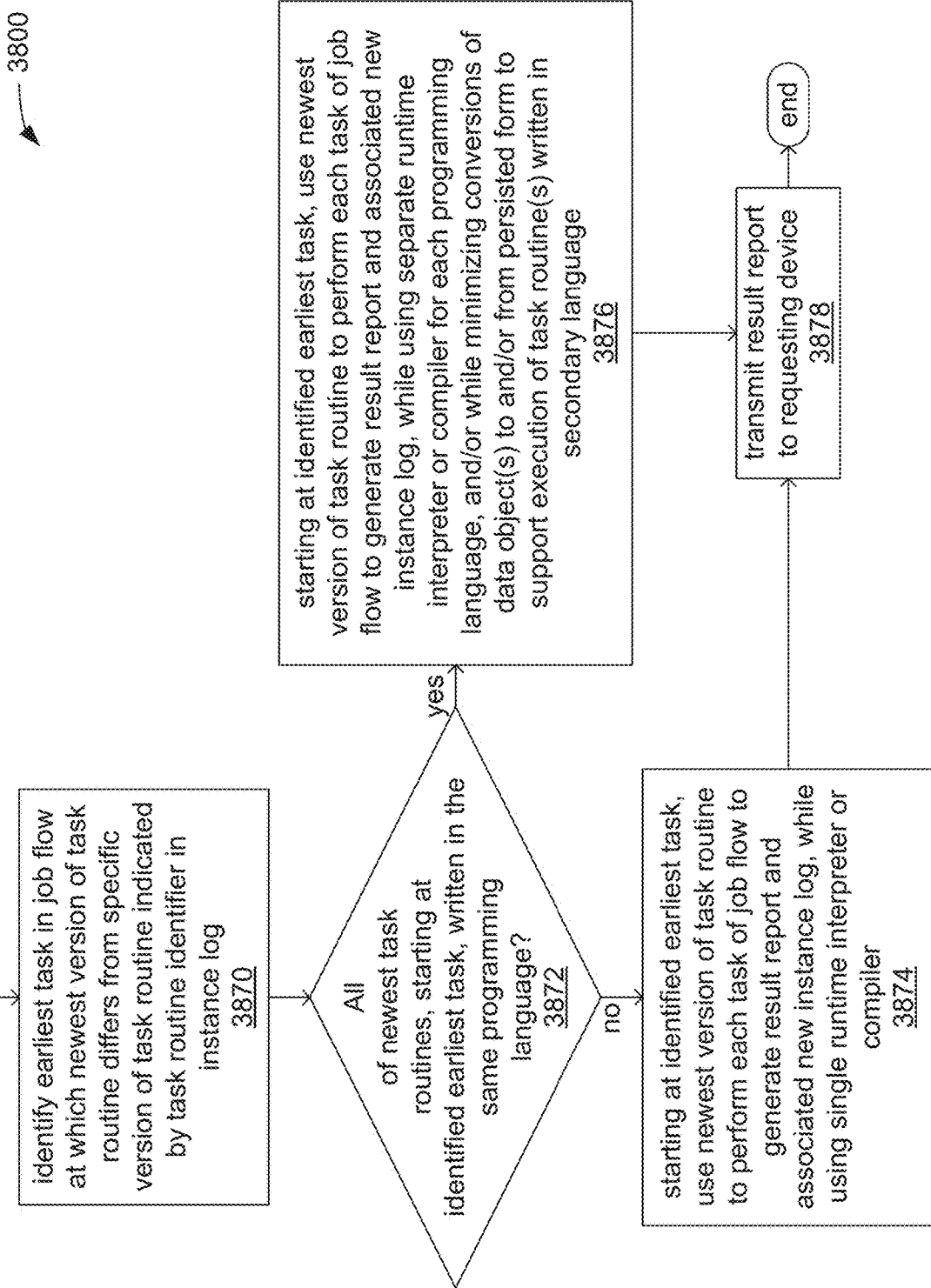
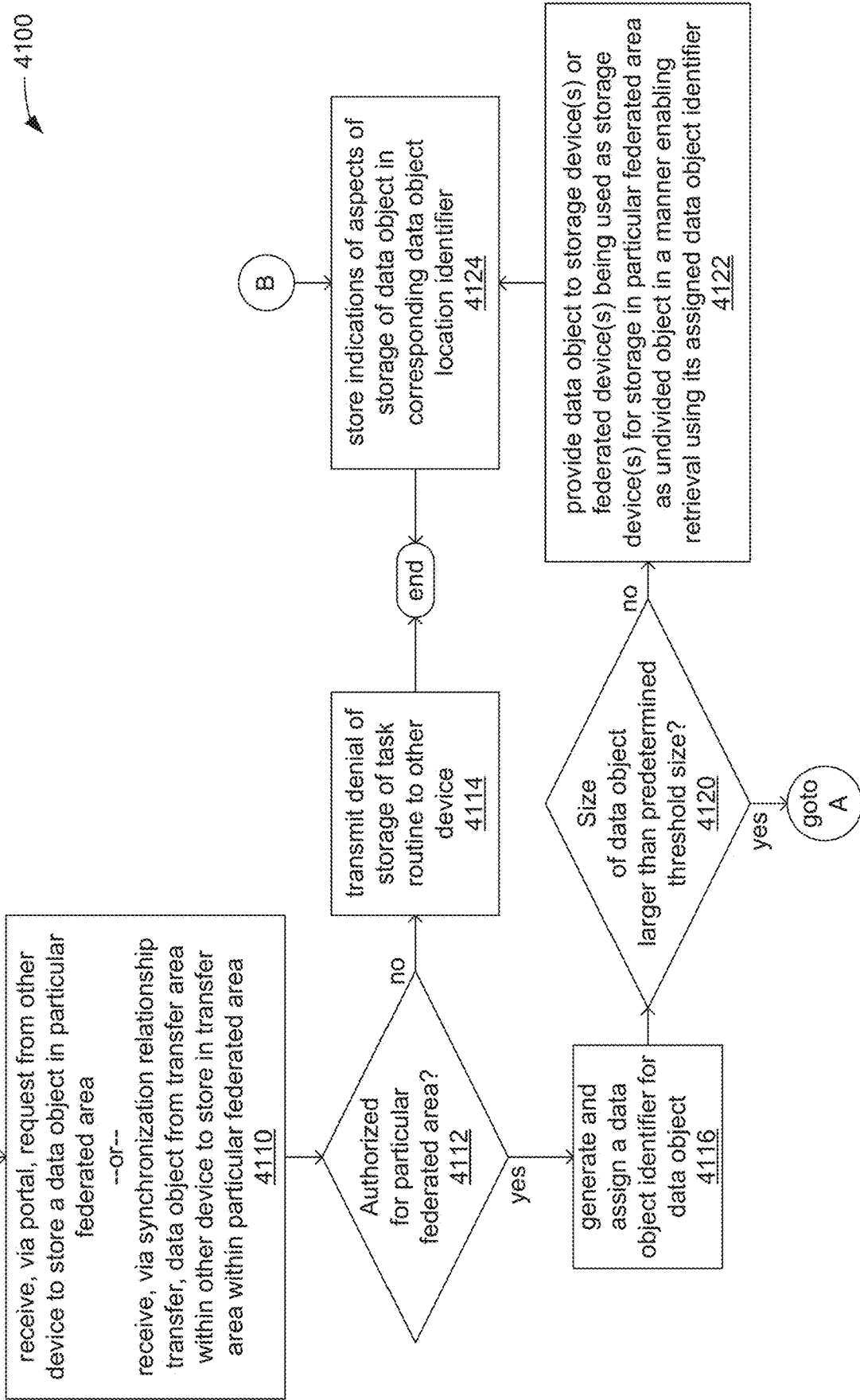

FIG. 34A



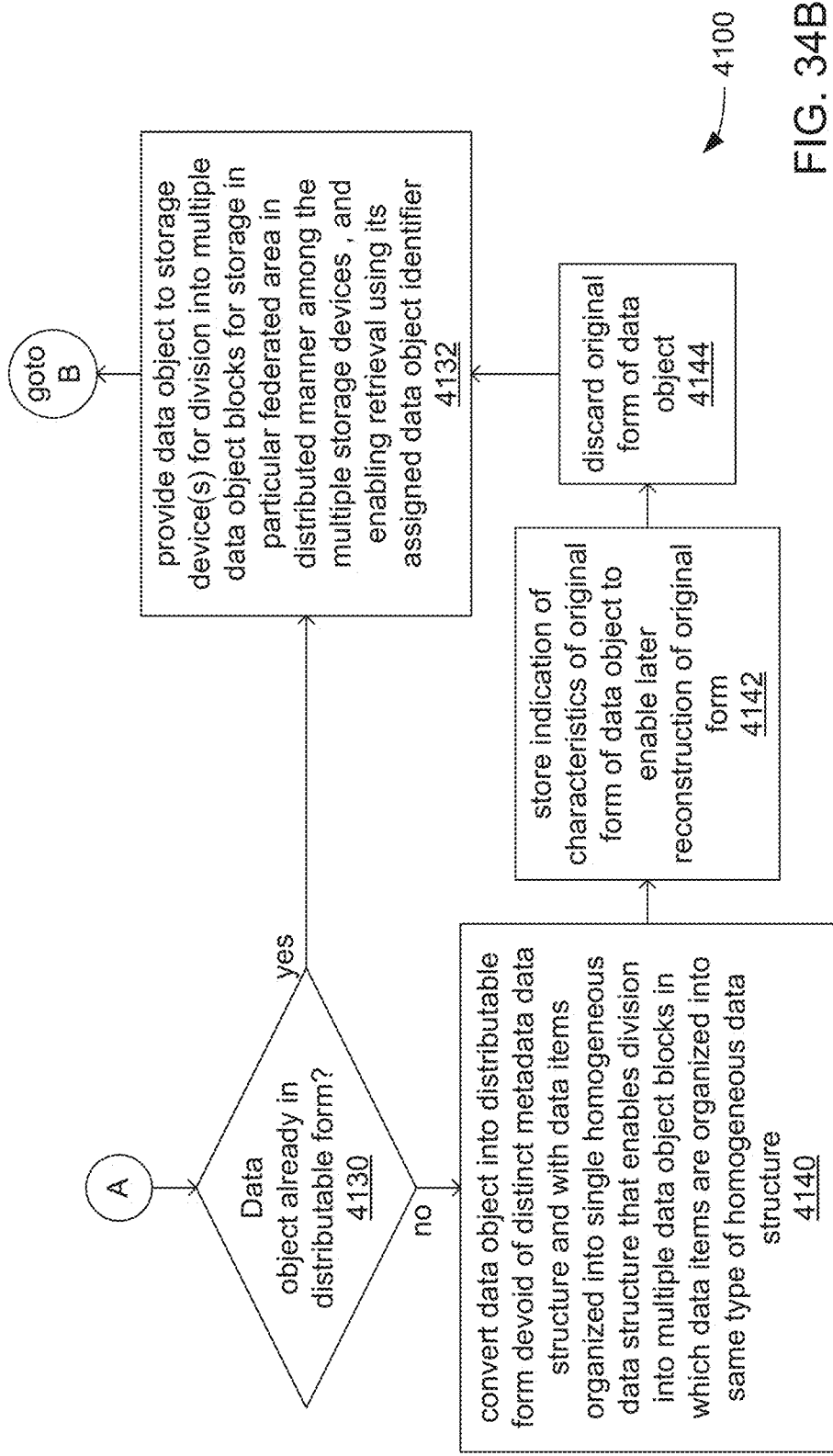

FIG. 34B

FIG. 35A

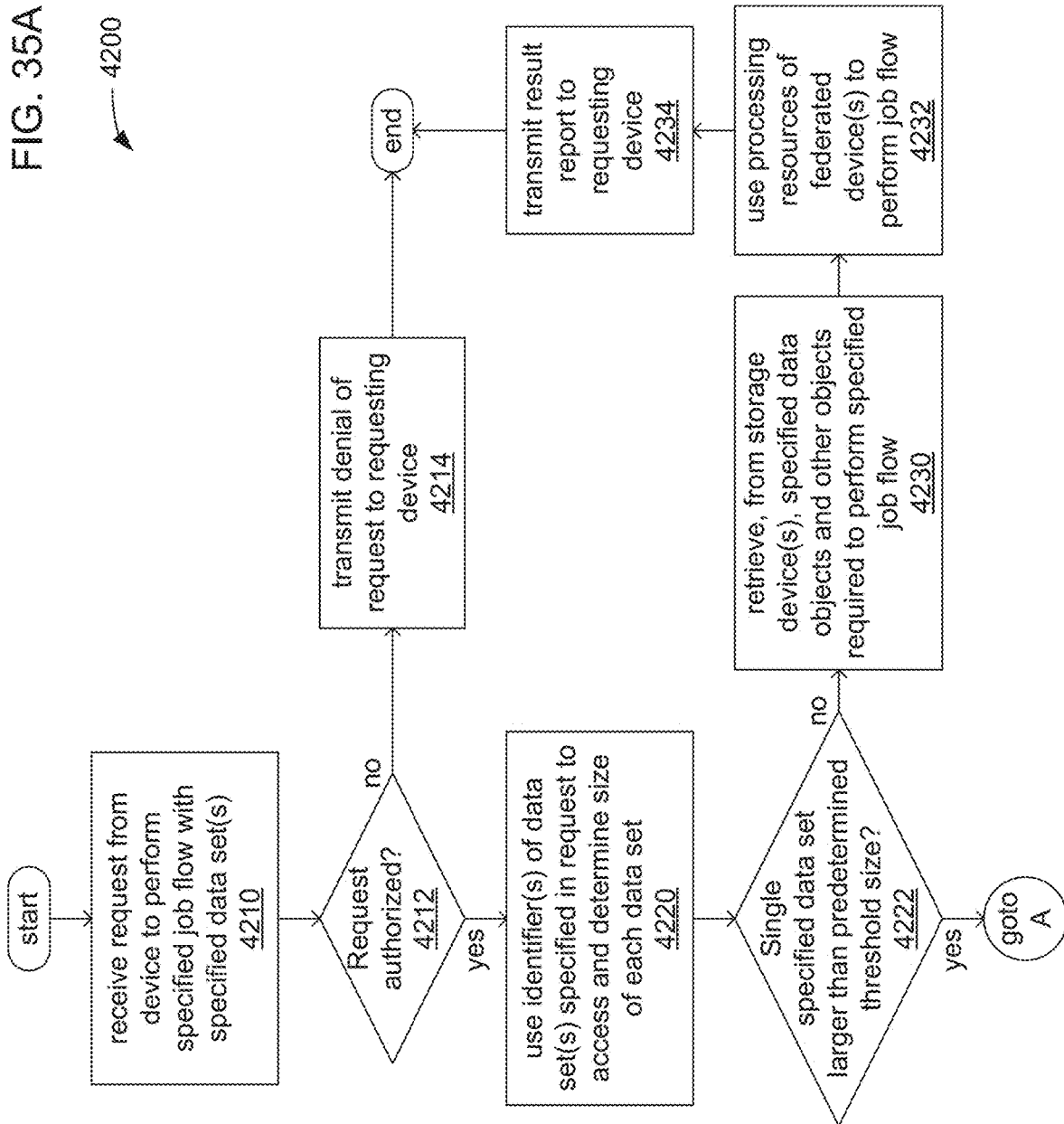

FIG. 35B

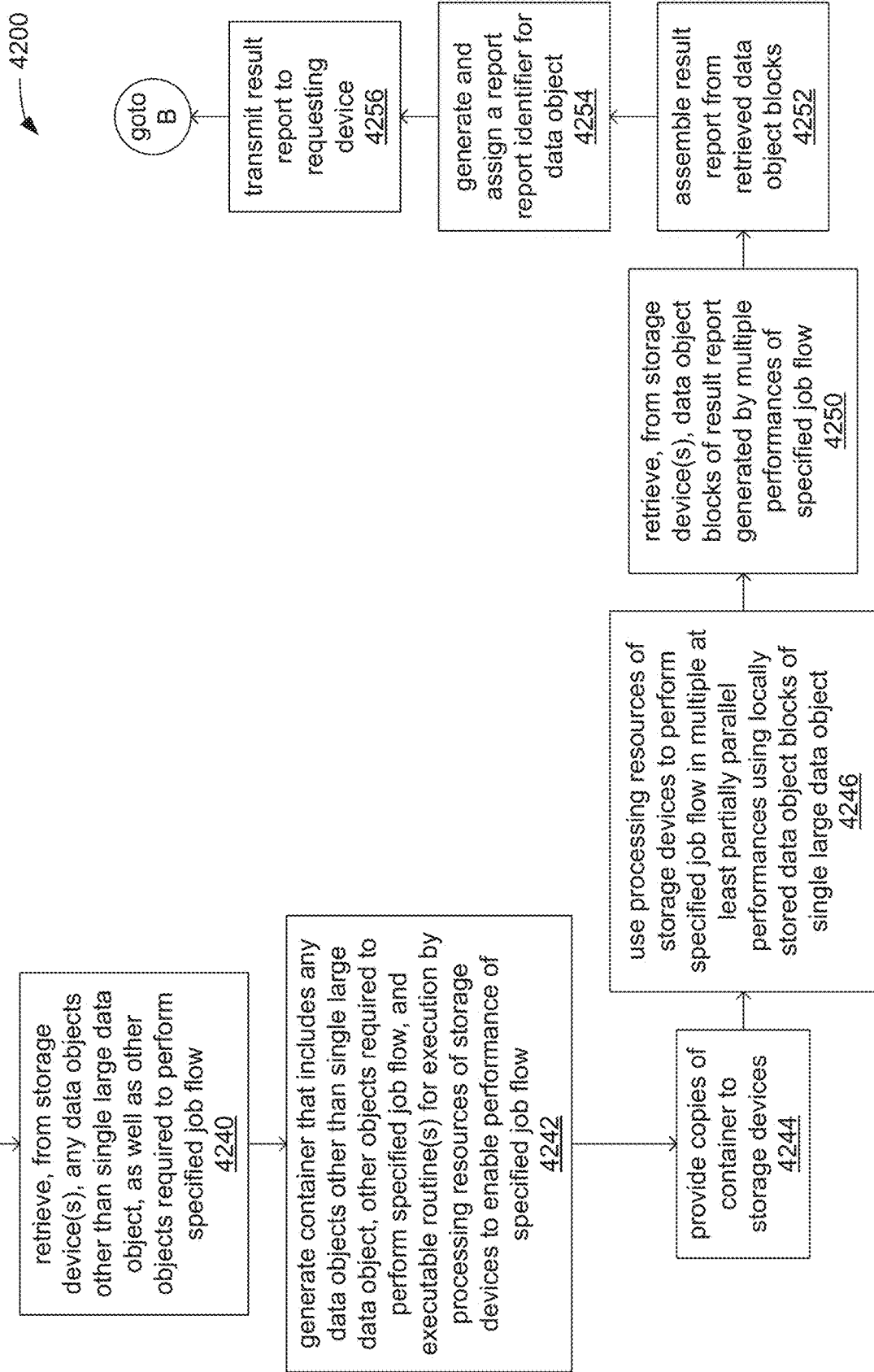

FIG. 35C

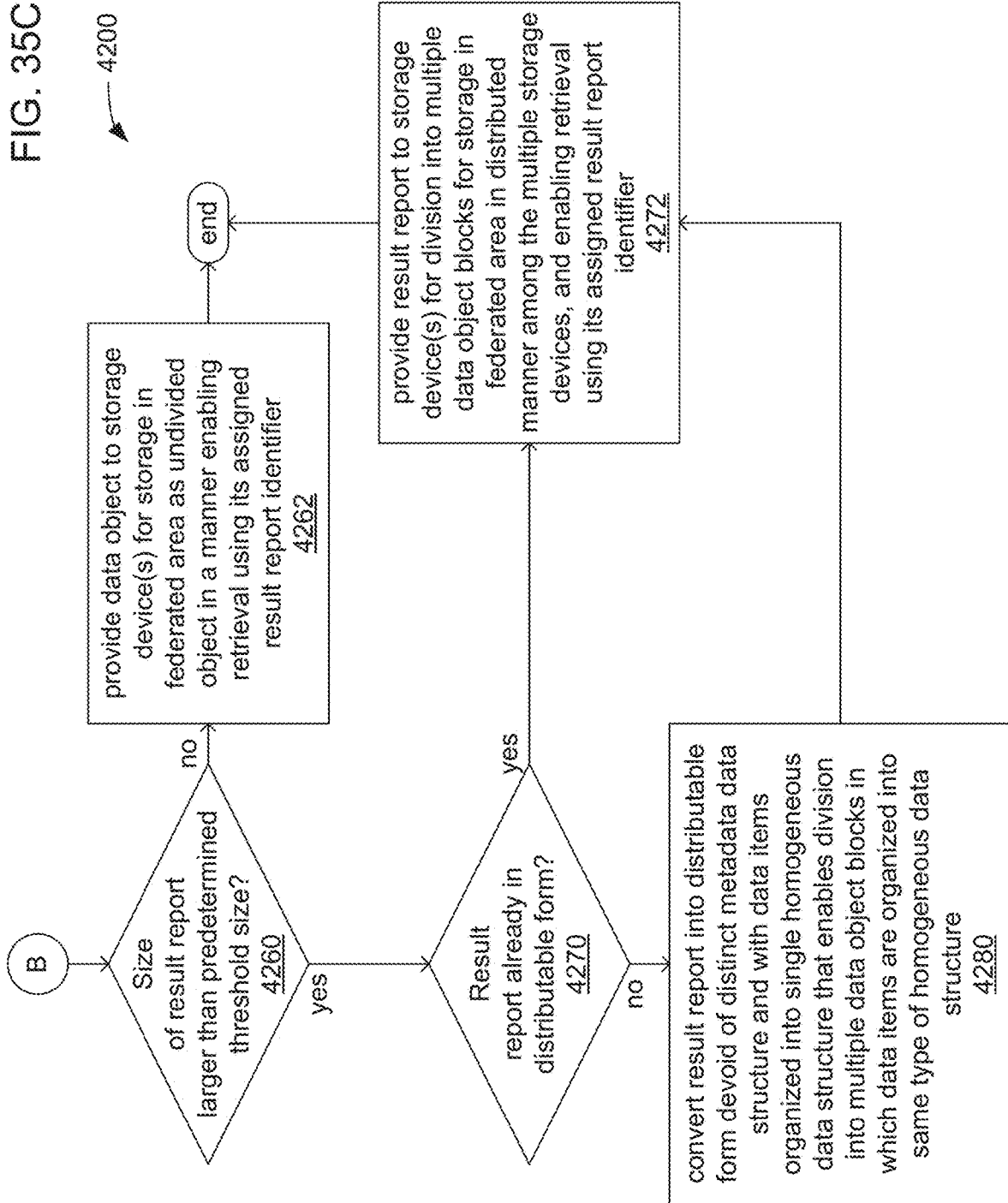

FIG. 36A

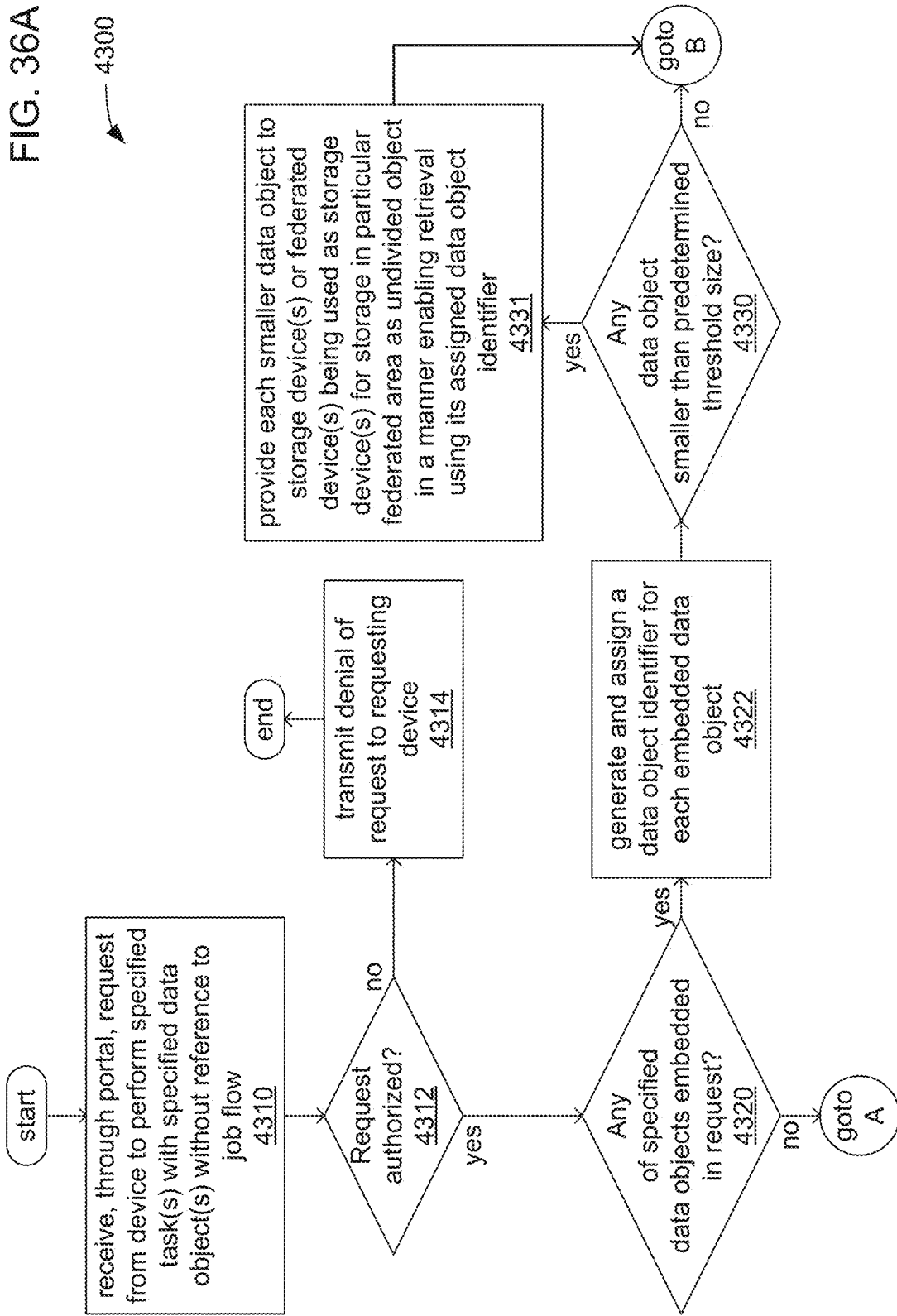

FIG. 36B

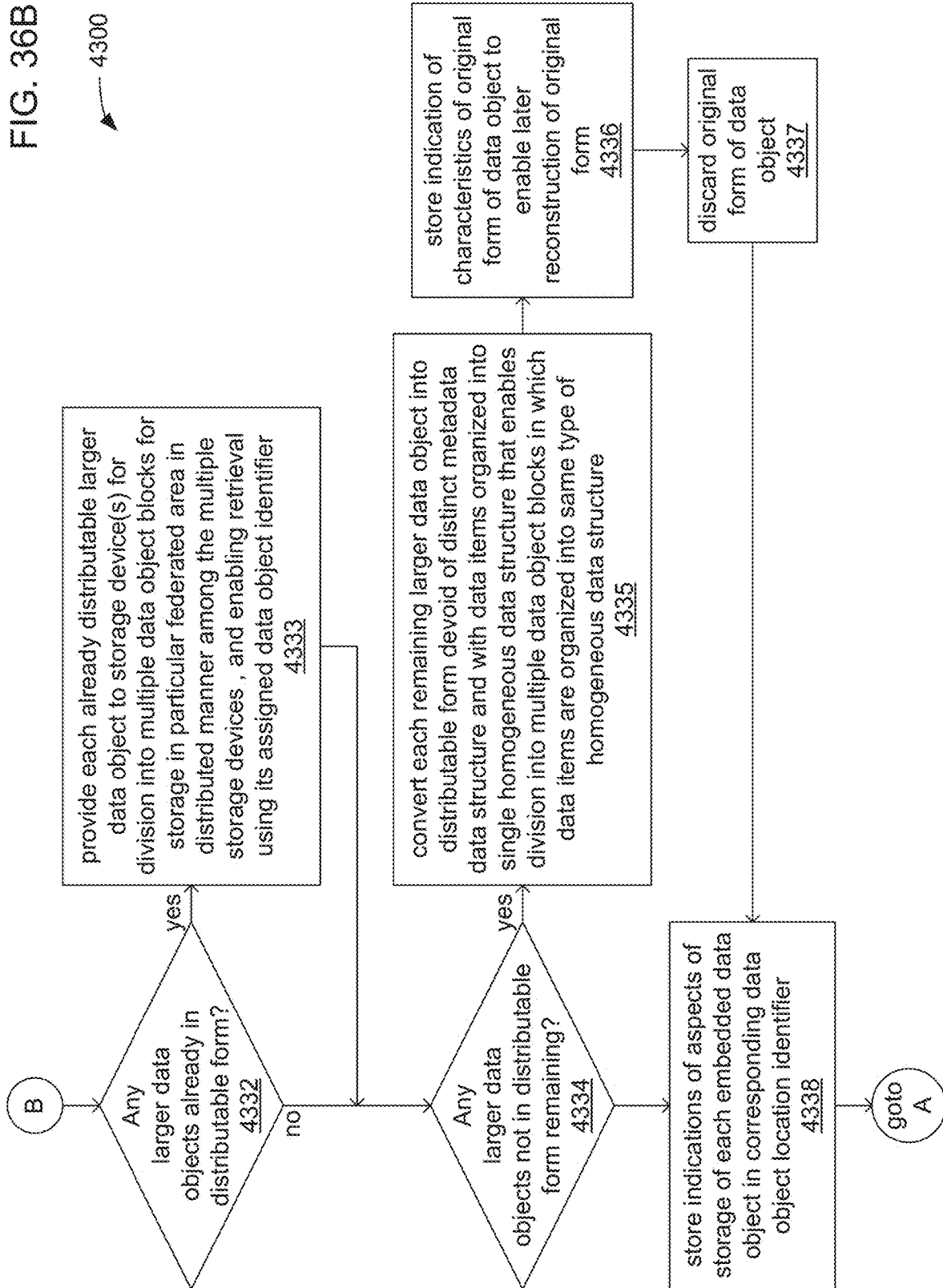
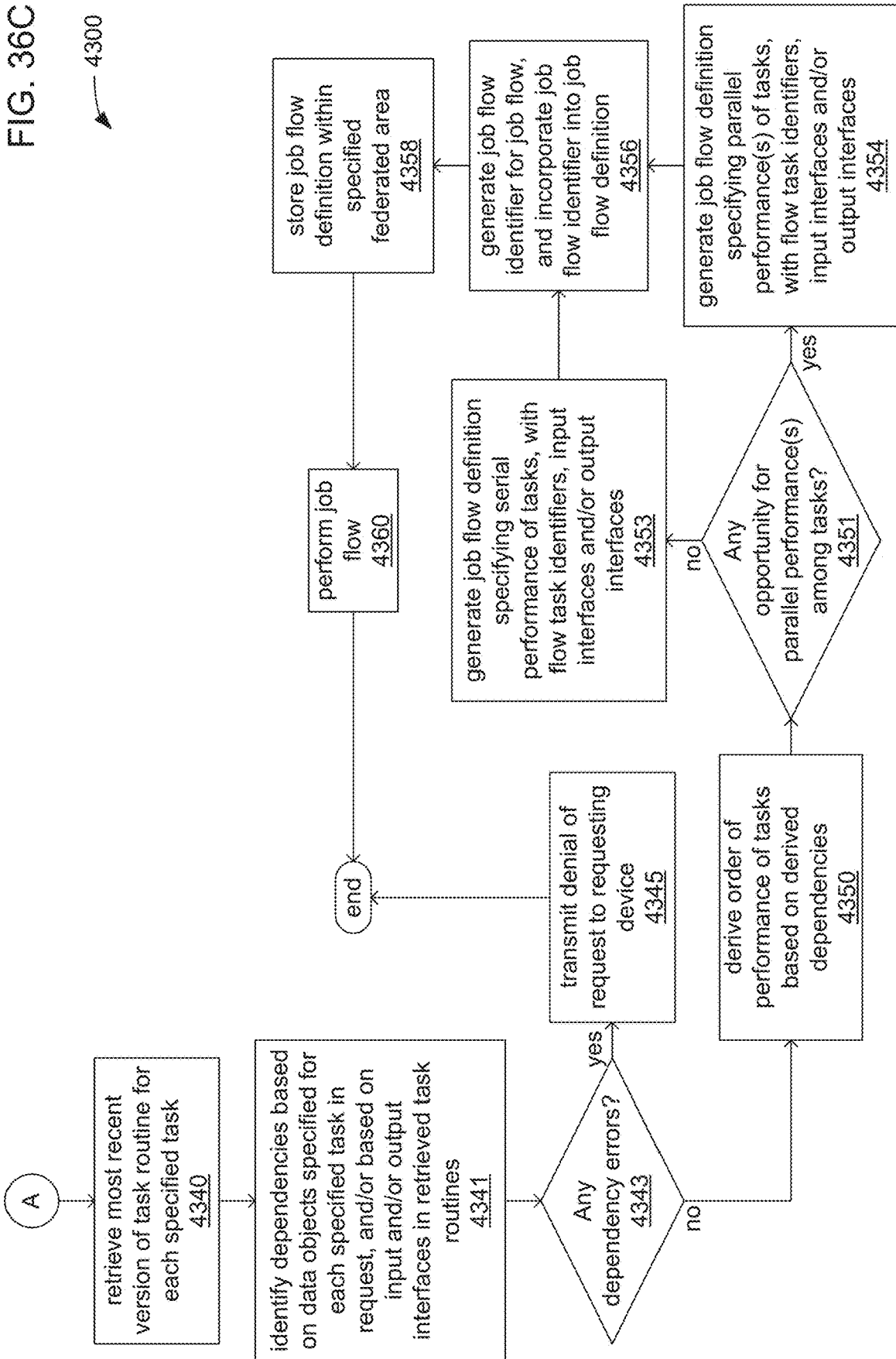

FIG. 36C



**AUTOMATED VIRTUAL MACHINE
RESOURCE MANAGEMENT IN
CONTAINER-SUPPORTED MANY TASK
COMPUTING**

CROSS-REFERENCE TO RELATED
APPLICATIONS

[0001] This application is a continuation-in-part of, and claims the benefit of priority under 35 U.S.C. § 120 to, U.S. patent application Ser. No. 17/682,783 filed Feb. 28, 2022; which is a continuation-in-part of, and claims the benefit of priority under 35 U.S.C. § 120 to, U.S. patent application Ser. No. 17/563,697 filed Dec. 28, 2021; which is a continuation of, and claims the benefit of priority under 35 U.S.C. § 120 to, U.S. patent application Ser. No. 17/558,237 filed Dec. 21, 2021; which is a continuation-in-part of, and claims the benefit of priority under 35 U.S.C. § 120 to, U.S. patent application Ser. No. 17/308,355 filed May 5, 2021 (since issued as U.S. Pat. No. 11,204,809); which is a continuation of, and claims the benefit of priority under 35 U.S.C. § 120 to, U.S. patent application Ser. No. 17/225,023 filed Apr. 7, 2021 (since issued as U.S. Pat. No. 11,169,788); which is a continuation-in-part of, and claims the benefit of priority under 35 U.S.C. § 120 to, U.S. patent application Ser. No. 17/139,364 filed Dec. 31, 2020 (since issued as U.S. Pat. No. 11,144,293); which is a continuation-in-part of, and claims the benefit of priority under 35 U.S.C. § 120 to, U.S. patent application Ser. No. 17/064,577 filed Oct. 6, 2020 (since issued as U.S. Pat. No. 11,080,031); which is a continuation-in-part of, and claims the benefit of priority under 35 U.S.C. § 120 to, U.S. patent application Ser. No. 16/814,481 filed Mar. 10, 2020 (since issued as U.S. Pat. No. 10,795,935); which is a continuation-in-part of, and claims the benefit of priority under 35 U.S.C. § 120 to, U.S. patent application Ser. No. 16/708,179 filed Dec. 9, 2019 (since issued as U.S. Pat. No. 10,740,076); which is a continuation-in-part of, and claims the benefit of priority under 35 U.S.C. § 120 to, U.S. patent application Ser. No. 16/587,965 filed Sep. 30, 2019 (since issued as U.S. Pat. No. 10,650,046); which is a continuation-in-part of, and claims the benefit of priority under 35 U.S.C. § 120 to, U.S. patent application Ser. No. 16/556,573 filed Aug. 30, 2019 (since issued as U.S. Pat. No. 10,650,045); which is a continuation-in-part of, and claims the benefit of priority under 35 U.S.C. § 120 to, U.S. patent application Ser. No. 16/539,222 filed Aug. 13, 2019 (since issued as U.S. Pat. No. 10,649,750); which is a continuation of, and claims the benefit of priority under 35 U.S.C. § 120 to, U.S. patent application Ser. No. 16/538,734 filed Aug. 12, 2019 (since issued as U.S. Pat. No. 10,642,896); which is a continuation-in-part of, and claims the benefit of priority under 35 U.S.C. § 120 to, U.S. patent application Ser. No. 16/223,518 filed Dec. 18, 2018 (since issued as U.S. Pat. No. 10,380,185); which is a continuation-in-part of, and claims the benefit of priority under 35 U.S.C. § 120 to, U.S. patent application Ser. No. 16/205,424 filed Nov. 30, 2018 (since issued as U.S. Pat. No. 10,346,476); which is a continuation-in-part of, and claims the benefit of priority under 35 U.S.C. § 120 to, U.S. patent application Ser. No. 15/897,723 filed Feb. 15, 2018 (since issued as U.S. Pat. No. 10,331,495); all of which are incorporated herein by reference in their respective entireties for all purposes.

[0002] U.S. patent application Ser. No. 16/538,734 is also a continuation-in-part of, and claims the benefit of priority under 35 U.S.C. § 120 to, U.S. patent application Ser. No.

16/236,401 filed Dec. 29, 2018 (since issued as U.S. Pat. No. 10,409,863); which is a continuation-in-part of, and claims the benefit of priority under 35 U.S.C. § 120 to, U.S. patent application Ser. No. 16/039,745 filed Jul. 19, 2018 (since issued as U.S. Pat. No. 10,360,069); which is a continuation-in-part of, and claims the benefit of priority under 35 U.S.C. § 120 to, the aforementioned U.S. patent application Ser. No. 15/897,723; all of which are incorporated herein by reference in their respective entireties for all purposes.

[0003] U.S. patent application Ser. No. 15/897,723 is a continuation-in-part of, and claims the benefit of priority under 35 U.S.C. § 120 to, U.S. patent application Ser. No. 15/896,613 filed Feb. 14, 2018 (since issued as U.S. Pat. No. 10,002,029); which is a continuation-in-part of, and claims the benefit of priority under 35 U.S.C. § 120 to, U.S. patent application Ser. No. 15/851,869 filed Dec. 22, 2017 (since issued as U.S. Pat. No. 10,078,710); which is a continuation of, and claims the benefit of priority under 35 U.S.C. § 120 to, U.S. patent application Ser. No. 15/613,516 filed Jun. 5, 2017 (since issued as U.S. Pat. No. 9,852,013); which is a continuation of, and claims the benefit of priority under 35 U.S.C. § 120 to, U.S. patent application Ser. No. 15/425,886 filed Feb. 6, 2017 (since issued as U.S. Pat. No. 9,684,544); which is a continuation of, and claims the benefit of priority under 35 U.S.C. § 120 to, U.S. patent application Ser. No. 15/425,749 also filed on Feb. 6, 2017 (since issued as U.S. Pat. No. 9,684,543); all of which are incorporated herein by reference in their respective entireties for all purposes.

[0004] This application also claims the benefit of priority under 35 U.S.C. § 119(e) to U.S. Provisional Application Ser. No. 63/185,570 filed May 7, 2021, and to U.S. Provisional Application Ser. No. 63/252,070 filed Oct. 4, 2021, both of which are incorporated herein by reference in their respective entireties for all purposes. U.S. patent application Ser. No. 17/682,783 also claims the benefit of priority under 35 U.S.C. § 119(e) to U.S. Provisional Application Ser. No. 63/157,419 filed Mar. 5, 2021, to U.S. Provisional Application Ser. No. 63/159,428 filed Mar. 10, 2021, to U.S. Provisional Application Ser. No. 63/185,570 filed May 7, 2021, and to U.S. Provisional Application Ser. No. 63/252,070 filed Oct. 4, 2021, all of which are incorporated herein by reference in their respective entireties for all purposes. U.S. patent application Ser. No. 17/558,237 also claims the benefit of priority under 35 U.S.C. § 119(e) to U.S. Provisional Application Ser. No. 63/139,703 filed Jan. 20, 2021, to U.S. Provisional Application Ser. No. 63/157,419 filed Mar. 5, 2021, and to U.S. Provisional Application Ser. No. 63/159,428 filed Mar. 10, 2021, all of which are incorporated herein by reference in their respective entireties for all purposes. Both U.S. patent application Ser. No. 17/225,023 and U.S. patent application Ser. No. 17/139,364 also claim the benefit of priority under 35 U.S.C. § 119(e) to U.S. Provisional Application Ser. No. 63/006,516 filed Apr. 7, 2020, to U.S. Provisional Application Ser. No. 63/008,830 filed Apr. 13, 2020, to U.S. Provisional Application Ser. No. 63/015,274 filed Apr. 24, 2020, and to U.S. Provisional Application Ser. No. 63/029,989 filed May 26, 2020, all of which are incorporated herein by reference in their respective entireties for all purposes. U.S. patent application Ser. No. 17/064,577 also claims the benefit of priority under 35 U.S.C. § 119(e) to U.S. Provisional Application Ser. No. 62/972,240 filed Feb. 10, 2020, and to U.S. Provisional Application Ser. No. 62/985,455 filed Mar. 5, 2020, both of which are incorporated herein by reference in their respec-

tive entireties for all purposes. U.S. patent application Ser. No. 16/814,481 also claims the benefit of priority under 35 U.S.C. § 119(e) to U.S. Provisional Application Ser. No. 62/816,160 filed Mar. 10, 2019, which is incorporated herein by reference in its entirety for all purposes. U.S. patent application Ser. No. 16/708,179 also claims the benefit of priority under 35 U.S.C. § 119(e) to U.S. Provisional Application Ser. No. 62/776,691 filed Dec. 7, 2018, which is incorporated herein by reference in its entirety for all purposes. U.S. patent application Ser. No. 16/587,965 also claims the benefit of priority under 35 U.S.C. § 119(e) to U.S. Provisional Application Ser. No. 62/739,314 filed Sep. 30, 2018, which is incorporated herein by reference in its entirety for all purposes. U.S. patent application Ser. No. 16/556,573 also claims the benefit of priority under 35 U.S.C. § 119(e) to U.S. Provisional Application Ser. No. 62/725,186 filed Aug. 30, 2018, which is incorporated herein by reference in its entirety for all purposes. U.S. patent application Ser. No. 16/538,734 also claims the benefit of priority under 35 U.S.C. § 119(e) to U.S. Provisional Application Ser. No. 62/717,873 filed Aug. 12, 2018, and to U.S. Provisional Application Ser. No. 62/801,173 filed Feb. 5, 2019, both of which are incorporated herein by reference in their respective entireties for all purposes.

[0005] U.S. patent application Ser. No. 16/223,518 also claims the benefit of priority under 35 U.S.C. § 119(e) to U.S. Provisional Application Ser. No. 62/654,643 filed Apr. 9, 2018, which is incorporated herein by reference in its entirety for all purposes. U.S. patent application Ser. No. 16/205,424 also claims the benefit of priority under 35 U.S.C. § 119(e) to U.S. Provisional Application Ser. No. 62/631,462 filed Feb. 15, 2018, which is incorporated herein by reference in its entirety for all purposes.

[0006] U.S. patent application Ser. No. 16/236,401 also claims the benefit of priority under 35 U.S.C. § 119(e) to U.S. Provisional Application Ser. No. 62/689,040 filed Jun. 22, 2018, which is incorporated herein by reference in its entirety for all purposes. U.S. patent application Ser. No. 16/039,745 also claims the benefit of priority under 35 U.S.C. § 119(e) to U.S. Provisional Application Ser. No. 62/534,678 filed Jul. 19, 2017, and to U.S. Provisional Application Ser. No. 62/560,506 filed Sep. 19, 2017, both of which are incorporated herein by reference in their respective entireties for all purposes.

[0007] U.S. patent application Ser. No. 15/896,613 also claims the benefit of priority under 35 U.S.C. § 119(e) to U.S. Provisional Application Ser. No. 62/460,000 filed Feb. 16, 2017, which is incorporated herein by reference in its entirety for all purposes. U.S. patent application Ser. No. 15/425,749 also claims the benefit of priority under 35 U.S.C. § 119(e) to U.S. Provisional Application Ser. No. 62/292,078 filed Feb. 5, 2016, and to U.S. Provisional Application Ser. No. 62/297,454 filed Feb. 19, 2016, both of which are incorporated herein by reference in their respective entireties for all purposes.

BACKGROUND

[0008] Distributed development and execution of task routines using pooled task routines with pooled data has advanced to an extent that the addition of mechanisms for organization of development and to provide oversight for reproducibility and accountability have become increasingly desired. In various scientific, technical and other areas, the quantities of data employed in performing analysis tasks

have become ever larger, thereby making desirable the pooling of data objects to enable collaboration, share costs and/or improve access. Also, such large quantities of data, by virtue of the amount and detail of the information they contain, have become of such value that it has become desirable to find as many uses as possible for such data in peer reviewing and in as wide a variety of analysis tasks as possible. Thus, the pooling of components of analysis routines to enable reuse, oversight and error checking has also become desirable.

[0009] Also, the increasingly predominant use of centralized distributed computing resources, including processing resources, storage and/or communications resources, has caused greater precision in the allocation of such resources to become increasingly desired. The approach of dedicating the resources of computing devices to remaining open and available for use by particular users and/or for particular purposes, regardless of degree of actual use such that those resources are frequently unused, has given way to the approach of more widely pooling and dynamically allocating and re-allocating even relatively small portions of such resources to many different users and/or for many different purposes. Thus, the ability to preemptively specify resource needs at a more granular level, and/or the ability to detect and address computational job failures at a more granular level has also become desirable.

SUMMARY

[0010] This summary is not intended to identify only key or essential features of the described subject matter, nor is it intended to be used in isolation to determine the scope of the described subject matter. The subject matter should be understood by reference to appropriate portions of the entire specification of this patent, any or all drawings, and each claim.

[0011] An apparatus includes at least one processor and a storage to store instructions that, when executed by the at least one processor, cause the at least one processor to perform operations including receive, at the at least one processor, and from a requesting device via a network, a request to perform a job flow, wherein: the job flow is defined in a job flow definition that specifies a set of tasks to be performed via execution of a corresponding set of task routines during a performance of the job flow, and that specifies data dependencies among the set of task routines; and the set of task routines are executed within a set of task containers instantiated within at least one virtual machine (VM). The at least one processor is also caused to store, within a job queue, a job performance request message including an indication of receiving the request to perform the job flow. The at least one processor is further caused to, within a performance container, execute instructions of a performance routine to cause the at least one processor to, in response to the storage of the job performance request message within the job queue, perform operations including: based on the data dependencies among the set of tasks specified in the job flow definition, derive an order of performance of the set of tasks that specifies a subset of tasks of the set of tasks that are able to be performed in parallel, and derive a quantity of task containers within the set of task containers that enables parallel execution of a corresponding subset of task routines to cause the parallel performance of the subset of tasks; based on at least the derived quantity of task containers within the set of task containers, derive a

quantity of at least one other VM that, in combination with the at least one VM, provides resources to enable instantiation of the derived quantity of task containers to enable the parallel execution of the subset of task routines; provide, to a VM allocation routine executed by the at least one processor, an indication of a need for provision of the at least one other VM, wherein execution of the VM allocation routine causes the at least one processor to allocate the at least one VM; and store, within a task queue, multiple task routine execution request messages that each comprise an identifier associated with a task of the subset of tasks to enable the parallel execution of the subset of task routines within the set of task containers.

[0012] A computer-program product tangibly embodied in a non-transitory machine-readable storage medium includes instructions operable to cause at least one processor to perform operations including receive, at the at least one processor, and from a requesting device via a network, a request to perform a job flow, wherein: the job flow is defined in a job flow definition that specifies a set of tasks to be performed via execution of a corresponding set of task routines during a performance of the job flow, and that specifies data dependencies among the set of task routines; and the set of task routines are executed within a set of task containers instantiated within at least one virtual machine (VM). The at least one processor is also caused to store, within a job queue, a job performance request message including an indication of receiving the request to perform the job flow. The at least one processor is further caused to, within a performance container, execute instructions of a performance routine to cause the at least one processor to, in response to the storage of the job performance request message within the job queue, perform operations including: based on the data dependencies among the set of tasks specified in the job flow definition, derive an order of performance of the set of tasks that specifies a subset of tasks of the set of tasks that are able to be performed in parallel, and derive a quantity of task containers within the set of task containers that enables parallel execution of a corresponding subset of task routines to cause the parallel performance of the subset of tasks; based on at least the derived quantity of task containers within the set of task containers, derive a quantity of at least one other VM that, in combination with the at least one VM, provides resources to enable instantiation of the derived quantity of task containers to enable the parallel execution of the subset of task routines; provide, to a VM allocation routine executed by the at least one processor, an indication of a need for provision of the at least one other VM, wherein execution of the VM allocation routine causes the at least one processor to allocate the at least one VM; and store, within a task queue, multiple task routine execution request messages that each comprise an identifier associated with a task of the subset of tasks to enable the parallel execution of the subset of task routines within the set of task containers.

[0013] The at least one processor may be caused to perform operations including, within the performance container, in response to at least storage of multiple execution completion messages within the task queue that are indicative of completion of execution of the subset of task routines, perform operations including: provide, to the VM allocation routine, an indication of cessation of the need for provision of the at least one other VM, wherein, the provision of the at least one other VM comprises at least one of

instantiating a VM of the at least one other VM, or providing access to a VM of the at least one other VM.

[0014] The allocation of the at least one VM may include allocation of at least one of processing resources or storage resources provided within at least one node device; and the provision of the at least one other VM may include a further allocation of the at least one of the processing resources or storage resources provided within the at least one node device.

[0015] The job flow definition may indicate that a task of the subset of tasks is of a task type that requires access to a particular resource that is provided by less than all node devices of the at least one node device. In executing the VM allocation routine, and in response to the indication that a task of the subset of tasks is of the task type, the at least one processor may be caused to perform operations including: analyze resources provided by each node device of the at least one node device to identify a node device that provides the particular resource; and provide a VM of the at least one other VM that is instantiated within the identified node device.

[0016] The at least one processor may execute resource allocation routine that causes the at least one processor to dynamically allocate multiple containers based on availability of resources within each VM of the at least one VM. In executing the resource allocation routine, and in response to the indication that a task of the subset of tasks is of the task type, the at least one processor may be caused to perform operations including: analyze resources provided by each VM of the at least one VM and of the at least one other VM to identify a VM that provides the particular resource; and provide a task container of the set of task containers that is instantiated within the identified VM.

[0017] The at least one processor may be caused to perform operations including, within each task container of the set of task containers, in response to the storage of a task routine execution request message within the task queue, analyze an identifier of the task type within the task routine execution request message to determine whether the task container supports a performance of a task of the task type, and in response to a determination that the task container supports the performance of a task of the task type, perform operations including: use an identifier of a task provided in the task routine execution request message to retrieve a corresponding task routine; and execute the retrieved corresponding task routine to cause the performance of the identified task.

[0018] The at least one processor may be caused to perform operations including, provide, to a resource allocation routine executed by the at least one processor, an indication of a need for provision of the derived quantity of task containers, wherein execution of the resource allocation routine causes the at least one processor to dynamically allocate multiple containers based on availability of at least one of processing resources or storage resources within the at least one VM.

[0019] The at least one processor may delay the provision, to the resource allocation routine, of the indication of the need for the provision of the derived quantity of task containers by a predetermined amount of time after the provision, to the VM allocation routine, of the indication of the need for provision of the at least one other VM to cause the provision of the resources to enable the instantiation of the quantity of task containers.

[0020] The at least one processor may be caused to perform operations including, within the performance container, in response to at least storage of multiple execution completion messages within the task queue that are indicative of completion of execution of the subset of task routines, perform operations including: provide, to the resource allocation routine, an indication of cessation of the need for provision of the derived quantity of task containers.

[0021] The dynamic allocation of the multiple containers may include dynamic allocation of multiple pods based on the availability of the at least one of processing resources or storage resources within the at least one VM; the performance container and a messaging container may be instantiated within a performance pod of the multiple pods; and within the messaging container, instructions of an instance of a messaging routine may be executed by the at least one processor to cause the at least one processor to provide the instance of the performance routine with access to the job queue and the task queue.

[0022] A computer-implemented method includes receiving, by at least one processor, and from a requesting device via a network, a request to perform a job flow, wherein: the job flow is defined in a job flow definition that specifies a set of tasks to be performed via execution of a corresponding set of task routines during a performance of the job flow, and that specifies data dependencies among the set of task routines; and the set of task routines are executed within a set of task containers instantiated within at least one virtual machine (VM). The method also includes storing, within a job queue, a job performance request message comprising an indication of receiving the request to perform the job flow. The method further includes, within a performance container, executing, by the at least one processor, instructions of a performance routine to cause the at least one processor to, in response to the storage of the job performance request message within the job queue, perform operations including: based on the data dependencies among the set of tasks specified in the job flow definition, deriving, by the at least one processor, an order of performance of the set of tasks that specifies a subset of tasks of the set of tasks that are able to be performed in parallel, and deriving, by the at least one processor, a quantity of task containers within the set of task containers that enables parallel execution of a corresponding subset of task routines to cause the parallel performance of the subset of tasks; based on at least the derived quantity of task containers within the set of task containers, deriving, by the at least one processor, a quantity of at least one other VM that, in combination with the at least one VM, provides resources to enable instantiation of the derived quantity of task containers to enable the parallel execution of the subset of task routines; providing, to a VM allocation routine executed by the at least one processor, an indication of a need for provision of the at least one other VM, wherein execution of the VM allocation routine causes the at least one processor to allocate the at least one VM; and storing, within a task queue, multiple task routine execution request messages that each comprise an identifier associated with a task of the subset of tasks to enable the parallel execution of the subset of task routines within the set of task containers.

[0023] The method may include, within the performance container, in response to at least storage of multiple execution completion messages within the task queue that are indicative of completion of execution of the subset of task

routines, performing operations including: providing, to the VM allocation routine, an indication of cessation of the need for provision of the at least one other VM, wherein, the provision of the at least one other VM comprises at least one of instantiating a VM of the at least one other VM, or providing access to a VM of the at least one other VM.

[0024] The allocation of the at least one VM may include allocation of at least one of processing resources or storage resources provided within at least one node device; and the provision of the at least one other VM may include a further allocation of the at least one of the processing resources or storage resources provided within the at least one node device.

[0025] The job flow definition may indicate that a task of the subset of tasks is of a task type that requires access to a particular resource that is provided by less than all node devices of the at least one node device. The method may include, in executing the VM allocation routine, and in response to the indication that a task of the subset of tasks is of the task type, performing operations including: analyzing, by the at least one processor, resources provided by each node device of the at least one node device to identify a node device that provides the particular resource; and providing a VM of the at least one other VM that is instantiated within the identified node device.

[0026] The at least one processor may execute a resource allocation routine that causes the at least one processor to dynamically allocate multiple containers based on availability of resources within each VM of the at least one VM. The method may include, in executing the resource allocation routine, and in response to the indication that a task of the subset of tasks is of the task type, performing operations including: analyzing, by the at least one processor, resources provided by each VM of the at least one VM and of the at least one other VM to identify a VM that provides the particular resource; and providing a task container of the set of task containers that is instantiated within the identified VM.

[0027] The method may include, within each task container of the set of task containers, in response to the storage of a task routine execution request message within the task queue, analyzing, by the at least one processor, an identifier of the task type within the task routine execution request message to determine whether the task container supports a performance of a task of the task type, and in response to a determination that the task container supports the performance of a task of the task type, performing operations including: using an identifier of a task provided in the task routine execution request message to retrieve a corresponding task routine; and executing, by the at least one processor, the retrieved corresponding task routine to cause the performance of the identified task.

[0028] The method may include providing, to a resource allocation routine executed by the at least one processor, an indication of a need for provision of the derived quantity of task containers, wherein execution of the resource allocation routine causes the at least one processor to dynamically allocate multiple containers based on availability of at least one of processing resources or storage resources within the at least one VM.

[0029] The method may include delaying the provision, to the resource allocation routine, of the indication of the need for the provision of the derived quantity of task containers by a predetermined amount of time after the provision, to the

VM allocation routine, of the indication of the need for provision of the at least one other VM to cause the provision of the resources to enable the instantiation of the quantity of task containers.

[0030] The method may include, within the performance container, in response to at least storage of multiple execution completion messages within the task queue that are indicative of completion of execution of the subset of task routines, performing operations including providing, to the resource allocation routine, an indication of cessation of the need for provision of the derived quantity of task containers.

[0031] The dynamic allocation of the multiple containers may include dynamic allocation of multiple pods based on the availability of the at least one of processing resources or storage resources within the at least one VM; the performance container and a messaging container may be instantiated within a performance pod of the multiple pods; and within the messaging container, instructions of an instance of a messaging routine may be executed by the at least one processor to cause the at least one processor to provide the instance of the performance routine with access to the job queue and the task queue.

[0032] An apparatus includes at least one processor and a storage to store instructions that, when executed by the at least one processor, cause the at least one processor to perform operations including, receive, at the at least one processor, and from a requesting device via a network, a request to provide a view of an object associated with a job flow, wherein: the job flow is defined in a job flow definition that specifies a set of tasks to be performed via execution of a corresponding set of task routines within a set of node devices during a performance of the job flow. The at least one processor is also caused to analyze the object to determine whether the object is associated with a task type that, during a performance of the job flow, requires access to a particular resource that is not accessible to a first interpretation routine that is executable by the at least one processor to cause generation of views of objects. The at least one processor is further caused to, in response to a determination that the object is associated with the task type, perform operations including store, within a job queue, a first job flow generation request message comprising a request to generate another job flow that causes generation of the requested view of the object when the other job flow is performed, and an indication of the task type; within a first task container, in response to the request to generate the other job flow, perform operations including analyze the task type to determine whether an instance of a second interpretation routine, that is executable by the at least one processor within the first task container, does have access to the particular resource, and in response to a determination that the instance of the second interpretation routine does have access to the particular resource, perform operations including execute instructions of the instance of the second interpretation routine to generate another job flow definition for the other job flow that specifies another set of tasks to be performed via execution of corresponding other set of task routines to generate the requested view of the object during a performance of the other job flow, and store, within a task queue, a first job flow generation completion message comprising an indication of completion of the generation of the other job flow definition; and after completion of the performance of the other job flow to generate the requested

view of the object, transmit a copy of the requested view of the object to the requesting device via the network.

[0033] A computer-program product tangibly embodied in a non-transitory machine-readable storage medium includes instructions operable to cause at least one processor to perform operations including, receive, at the at least one processor, and from a requesting device via a network, a request to provide a view of an object associated with a job flow, wherein: the job flow is defined in a job flow definition that specifies a set of tasks to be performed via execution of a corresponding set of task routines within a set of node devices during a performance of the job flow. The at least one processor is also caused to analyze the object to determine whether the object is associated with a task type that, during a performance of the job flow, requires access to a particular resource that is not accessible to a first interpretation routine that is executable by the at least one processor to cause generation of views of objects. The at least one processor is further caused to, in response to a determination that the object is associated with the task type, perform operations including store, within a job queue, a first job flow generation request message comprising a request to generate another job flow that causes generation of the requested view of the object when the other job flow is performed, and an indication of the task type; within a first task container, in response to the request to generate the other job flow, perform operations including analyze the task type to determine whether an instance of a second interpretation routine, that is executable by the at least one processor within the first task container, does have access to the particular resource, and in response to a determination that the instance of the second interpretation routine does have access to the particular resource, perform operations including execute instructions of the instance of the second interpretation routine to generate another job flow definition for the other job flow that specifies another set of tasks to be performed via execution of corresponding other set of task routines to generate the requested view of the object during a performance of the other job flow, and store, within a task queue, a first job flow generation completion message comprising an indication of completion of the generation of the other job flow definition; and after completion of the performance of the other job flow to generate the requested view of the object, transmit a copy of the requested view of the object to the requesting device via the network.

[0034] In response to a determination that the object is not associated with the task type, the at least one processor may be caused to perform operations including execute instructions of the instance of the first interpretation routine to generate the requested view of the object.

[0035] In response to a determination that the object is not associated with the task type, the at least one processor may be caused to perform operations including: before commencement of execution of instructions of the first interpretation routine to generate the requested view of the object, store, within the job queue, an object view generation message comprising an indication of the generation of the requested view of the object as underway, and an identifier of the instance of the first interpretation routine to provide an indication to another instance of the first interpretation routine of which instance of the first interpretation routine is currently involved in generating the requested view of the

object; and after completion of the generation of the requested view of the object, remove the object view generation message.

[0036] In response to the determination that the object is associated with the task type, the at least one processor may be caused to perform operations including: within a performance container, in response to the storage of the first job flow generation request message within the job queue, store a second job flow generation request message within a task queue; within the first task container, perform operations including retrieve an indication of the task type from the second job flow generation request message stored within the task queue to enable the analysis of the task type, and, after completion of the generation of the other job flow definition, include a copy of the other job flow definition in the first job flow generation completion message stored within the task queue; within the performance container, in response to the storage of the first job flow generation completion message within the task queue, store a second job flow generation completion message within the job queue; and in response to the storage of the second job flow generation completion message within the job queue, store, within the job queue, a job performance request message comprising a request to perform the other job flow to generate the requested view of the object.

[0037] The at least one processor may be caused, within a second task container, in response to the request to generate the other job flow, to perform operations including: analyze the task type to determine whether an instance of a second interpretation routine, that is executable by the at least one processor within the second task container, does have access to the particular resource; and in response to a determination that the instance of the second interpretation routine does not have access to the particular resource, refrain from performing operations to generate the other job flow definition.

[0038] The first task container may be instantiated within a first node device of the set of node devices; the first node device may provide access to the particular resource; the second task container may be instantiated within a second node device of the set of node devices; and the second node device may not provide access to the particular resource.

[0039] The first task container may be instantiated within a first virtual machine (VM) that is instantiated within the first node device; the first VM may provide the first task container with access to the particular resource; and the second task container may be instantiated within a second VM that is instantiated within the second node device.

[0040] The particular resource may include an alternate processor incorporated into a particular node device of the set of node devices; the object may include a data set in which data values are organized in a manner that requires use of the alternate processor to perform at least one operation on the data values; analyzing the object to determine whether the object is associated with the task type may include at least one of analyzing metadata associated with the object or analyzing a portion of an identifier of the object; and at least one task of the other set of tasks specified in the other job flow definition may include using the alternate processor to perform the at least one operation on the data values.

[0041] The particular resource may include a set of restricted data objects to which access is restricted to being provided by a particular node device of the set of node devices; the object may include a data object of the set of

restricted data objects; analyzing the object to determine whether the object is associated with the task type may include at least one of analyzing metadata associated with the object or analyzing a portion of an identifier of the object; and at least one task of the other set of tasks specified in the other job flow definition may include retrieving the object from among the set of restricted objects from within a task container instantiated within the particular node device.

[0042] The particular resource may include the second interpretation routine; the second interpretation routine may be executable by the at least one processor to interpret instructions written in a particular programming language; the first interpretation routine may not be able to be executed by the at least one processor to interpret instructions written in the particular programming language; the object may include a task routine that comprises instructions written in the particular programming language; analyzing the object to determine whether the object is associated with the task type may include analyzing at least one of executable instructions or comments within the object, or analyzing a portion of an identifier of the object; and at least one task of the other set of tasks specified in the other job flow definition may include interpreting the instructions within the task routine that are written in the particular programming language.

[0043] A computer-implemented method includes: receiving, by the at least one processor, and from a requesting device via a network, a request to provide a view of an object associated with a job flow, wherein the job flow is defined in a job flow definition that specifies a set of tasks to be performed via execution of a corresponding set of task routines within a set of node devices during a performance of the job flow; and analyzing, by the at least one processor, the object to determine whether the object is associated with a task type that, during a performance of the job flow, requires access to a particular resource that is not accessible to a first interpretation routine that is executable by the at least one processor to cause generation of views of objects. The method also includes, in response to a determination that the object is associated with the task type, performing operations including: storing, within a job queue, a first job flow generation request message comprising a request to generate another job flow that causes generation of the requested view of the object when the other job flow is performed, and an indication of the task type; within a first task container, in response to the request to generate the other job flow, performing operations including analyzing, by the at least one processor, the task type to determine whether an instance of a second interpretation routine, that is executable by the at least one processor within the first task container, does have access to the particular resource, and in response to a determination that the instance of the second interpretation routine does have access to the particular resource, performing operations including executing, by the at least one processor, instructions of the instance of the second interpretation routine to generate another job flow definition for the other job flow that specifies another set of tasks to be performed via execution of corresponding other set of task routines to generate the requested view of the object during a performance of the other job flow, and storing, within a task queue, a first job flow generation completion message comprising an indication of completion of the generation of the other job flow definition; and after

completion of the performance of the other job flow to generate the requested view of the object, transmitting, from the at least one processor, a copy of the requested view of the object to the requesting device via the network.

[0044] The method may also include, in response to a determination that the object is not associated with the task type, performing operations including: executing, by the at least one processor, instructions of the instance of the first interpretation routine to generate the requested view of the object.

[0045] The method may also include, in response to a determination that the object is not associated with the task type, performing operations including: before commencement of execution of instructions of the first interpretation routine to generate the requested view of the object, storing, within the job queue, an object view generation message comprising an indication of the generation of the requested view of the object as underway, and an identifier of the instance of the first interpretation routine to provide an indication to another instance of the first interpretation routine of which instance of the first interpretation routine is currently involved in generating the requested view of the object; and after completion of the generation of the requested view of the object, removing the object view generation message.

[0046] The method may also include, in response to the determination that the object is associated with the task type, performing operations including: within a performance container, in response to the storage of the first job flow generation request message within the job queue, storing a second job flow generation request message within a task queue; within the first task container, performing operations including retrieving, by the at least one processor, an indication of the task type from the second job flow generation request message stored within the task queue to enable the analysis of the task type, and after completion of the generation of the other job flow definition, including, by the at least one processor, a copy of the other job flow definition in the first job flow generation completion message stored within the task queue; within the performance container, in response to the storage of the first job flow generation completion message within the task queue, storing a second job flow generation completion message within the job queue; and in response to the storage of the second job flow generation completion message within the job queue, storing, within the job queue, a job performance request message comprising a request to perform the other job flow to generate the requested view of the object.

[0047] The method may also include, within a second task container, in response to the request to generate the other job flow, performing operations including: analyzing, by the at least one processor, the task type to determine whether an instance of a second interpretation routine, that is executable by the at least one processor within the second task container, does have access to the particular resource; and in response to a determination that the instance of the second interpretation routine does not have access to the particular resource, refraining from performing operations to generate the other job flow definition.

[0048] The first task container may be instantiated within a first node device of the set of node devices; the first node device may provide access to the particular resource; the second task container may be instantiated within a second

node device of the set of node devices; and the second node device may not provide access to the particular resource.

[0049] The first task container may be instantiated within a first virtual machine (VM) that is instantiated within the first node device; the first VM may provide the first task container with access to the particular resource; and the second task container may be instantiated within a second VM that is instantiated within the second node device.

[0050] The particular resource may include an alternate processor incorporated into a particular node device of the set of node devices; the object may include a data set in which data values are organized in a manner that requires use of the alternate processor to perform at least one operation on the data values; analyzing the object to determine whether the object is associated with the task type may include at least one of analyzing metadata associated with the object or analyzing a portion of an identifier of the object; and at least one task of the other set of tasks specified in the other job flow definition may include using the alternate processor to perform the at least one operation on the data values.

[0051] The particular resource may include a set of restricted data objects to which access is restricted to being provided by a particular node device of the set of node devices; the object may include a data object of the set of restricted data objects; analyzing the object to determine whether the object is associated with the task type may include at least one of analyzing metadata associated with the object or analyzing a portion of an identifier of the object; and at least one task of the other set of tasks specified in the other job flow definition may include retrieving the object from among the set of restricted objects from within a task container instantiated within the particular node device.

[0052] The particular resource may include the second interpretation routine; the second interpretation routine may be executable by the at least one processor to interpret instructions written in a particular programming language; the first interpretation routine may not be able to be executed by the at least one processor to interpret instructions written in the particular programming language; the object may include a task routine that comprises instructions written in the particular programming language; analyzing the object to determine whether the object is associated with the task type may include analyzing at least one of executable instructions or comments within the object, or analyzing a portion of an identifier of the object; and at least one task of the other set of tasks specified in the other job flow definition may include interpreting the instructions within the task routine that are written in the particular programming language.

[0053] The foregoing, together with other features and embodiments, will become more apparent upon referring to the following specification, claims, and accompanying drawings.

BRIEF DESCRIPTION OF THE DRAWINGS

[0054] The present disclosure is described in conjunction with the appended figures:

[0055] FIG. 1 illustrates a block diagram that provides an illustration of the hardware components of a computing system, according to some embodiments of the present technology.

[0056] FIG. 2 illustrates an example network including an example set of devices communicating with each other over an exchange system and via a network, according to some embodiments of the present technology.

[0057] FIG. 3 illustrates a representation of a conceptual model of a communications protocol system, according to some embodiments of the present technology.

[0058] FIG. 4 illustrates a communications grid computing system including a variety of control and worker nodes, according to some embodiments of the present technology.

[0059] FIG. 5 illustrates a flow chart showing an example process for adjusting a communications grid or a work project in a communications grid after a failure of a node, according to some embodiments of the present technology.

[0060] FIG. 6 illustrates a portion of a communications grid computing system including a control node and a worker node, according to some embodiments of the present technology.

[0061] FIG. 7 illustrates a flow chart showing an example process for executing a data analysis or processing project, according to some embodiments of the present technology.

[0062] FIG. 8 illustrates a block diagram including components of an Event Stream Processing Engine (ESPE), according to embodiments of the present technology.

[0063] FIG. 9 illustrates a flow chart showing an example process including operations performed by an event stream processing engine, according to some embodiments of the present technology.

[0064] FIG. 10 illustrates an ESP system interfacing between a publishing device and multiple event subscribing devices, according to embodiments of the present technology.

[0065] FIG. 11 illustrates a flow chart showing an example process of generating and using a machine-learning model according to some aspects.

[0066] FIG. 12 illustrates an example machine-learning model based on a neural network.

[0067] FIGS. 13A, 13B, 13C, 13D, 13E, 13F, 13G and 13H, together, illustrate an example embodiment of a distributed processing system.

[0068] FIGS. 14A and 14B, together, illustrate an example alternate embodiment of a distributed processing system.

[0069] FIGS. 15A, 15B, 15C, 15D, 15E, 15F, 15G, 15H, 15I, 15J and 15K, together, illustrate aspects of example hierarchical sets of federated areas and their formation.

[0070] FIGS. 16A, 16B, 16C, 16D, 16E, 16F, 16G, 16H, 16I, 16J, 16K and 16L, together, illustrate an example of defining, performing and documenting a job flow.

[0071] FIGS. 17A, 17B, 17C, 17D, 17E and 17F, together, illustrate an example of selectively storing, translating and assigning identifiers to objects in federated area(s).

[0072] FIGS. 18A, 18B, 18C, 18D, 18E, 18F and 18G, together, illustrate an example of organizing, indexing and retrieving objects from federated area(s).

[0073] FIGS. 19A, 19B, 19C, 19D, 19E and 19F, together, illustrate aspects of the generation and use of a DAG.

[0074] FIGS. 20A, 20B, 20C, 20D, 20E, 20F, 20G, 20H, 20I and 20J, together, illustrate an example of using a messaging architecture to coordinate the execution of routines (including task routines) among dynamically allocated containers.

[0075] FIGS. 21A and 21B, together, illustrate aspects of exchanging objects between a distributed processing system with the architecture of FIGS. 20A-I and an external device.

[0076] FIGS. 22A, 22B, 22C, 22D, 22E, 22F, 22G, 22H and 22I, together, illustrate an example of using the messaging architecture of FIGS. 20A-I to coordinate a job flow performance.

[0077] FIGS. 23A, 23B and 23C, together, illustrate an example of using the messaging architecture of FIGS. 20A-I to automatically cancel a job flow performance.

[0078] FIGS. 24A, 24B, 24C and 24D, together, illustrate an example of using the messaging architecture of FIGS. 20A-I to effectuate a commanded cancellation of a job flow performance.

[0079] FIGS. 25A, 25B, 25C, 25D, 25E, 25F, 25G and 25H, together, illustrate an example of effectuating coherency in federated areas across multiple federated devices using DAGs and the messaging architecture of FIGS. 20A-I.

[0080] FIGS. 26A and 26B, together, illustrate an example embodiment of a logic flow of a federated device adding a requested federated area related to one or more other federated areas.

[0081] FIGS. 27A, 27B, 27C, 27D, 27E, 27F and 27G, together, illustrate an example embodiment of a logic flow of a federated device storing objects in a federated area.

[0082] FIGS. 28A, 28B and 28C, together, illustrate an example embodiment of a logic flow of a federated device storing a task routine in a federated area.

[0083] FIGS. 29A, 29B and 29C, together, illustrate an example embodiment of a logic flow of a federated device storing a job flow definition in a federated area.

[0084] FIGS. 30A, 30B, 30C and 30D, together, illustrate an example embodiment of a logic flow of a federated device deleting objects stored within a federated area.

[0085] FIGS. 31A and 31B, together, illustrate an example embodiment of a logic flow of a federated device either repeating an earlier performance of a job flow that generated a specified result report or instance log, or transmitting objects to enable a requesting device to do so.

[0086] FIGS. 32A and 32B, together, illustrate another example embodiment of a logic flow of a federated device repeating an earlier performance of a job flow.

[0087] FIGS. 33A, 33B, 33C and 33D, together, illustrate an example embodiment of a logic flow of a federated device performing a job flow.

[0088] FIGS. 34A and 34B, together, illustrate an example embodiment of a logic flow of a federated device storing a data object in a federated area.

[0089] FIGS. 35A, 35B and 35C, together, illustrate another example embodiment of a logic flow of a federated device performing a job flow.

[0090] FIGS. 36A, 36B and 36C, together, illustrate another example embodiment of a logic flow of a federated device performing a set of tasks specified in a request as a job flow.

DETAILED DESCRIPTION

[0091] A distributed processing system may employ a resource allocation routine to dynamically assign and monitor the use of processing, storage and/or communications resources of one or more computing devices used to implement MTC. MTC, and the breaking up of a complex analysis into job flows with associated sets of tasks, may be used together to enable a high degree of parallelism in the performance of those analyses. Developers are able to divide such a complex analysis into a set of tasks to be performed, are able to separately develop a task routine (or reuse a

previously developed task routine) to perform each task, and are able to generate a job flow definition that specifies inputs and outputs of the job flow, as well as data dependencies among the tasks. Upon performance of the analysis, the job flow definition is analyzed to identify opportunities, afforded by instances of lack of dependency among the tasks, to perform various subsets of the tasks in parallel as part of dynamically deriving and effectuating an order of performance of those tasks that takes advantage of varying levels of available processing, storage and/or communications resources of the distributed processing system.

[0092] As part of enabling such advantage to be taken of such varying available resources, a resource allocation routine may be executed to provide a quantity of pods that is dynamically alterable based on the varying levels of availability and/or use of such resources. Each pod may include at least one container environment to which at least one thread of execution is assigned to execute an instance of a routine therein. Some of the pods may be employed in executing instances of task routines to perform corresponding tasks of job flows. Others of the pods may be employed in executing instances of various routines that control the performance of job flows, including the derivation and effectuation of an order of performance of tasks of a job flow through the execution of instances of task routines. The order in which task routines within such isolated environments are executed to effectuate the derived order of performance of their corresponding tasks may be coordinated through a set of message queues. Such coordination may be entirely independent of the dynamic provision of the pods by the resource allocation routine(s) such that it is possible for the execution of instances of task routines, and/or of routines that coordinate the execution of the task routines, to be interrupted or otherwise impaired by various events, including instances of un instantiation of the pods within which they are executed. The set of message queues may be used to implement various protocols that aid in ensuring that such events will not prevent job flows from being successfully performed.

[0093] As will be familiar to those skilled in the art, the efficient allocation of resources of computing devices to perform operations therein is a longstanding challenge that has been addressed with numerous solutions over multiple decades. In recent years, the dynamic allocation of containers providing a dynamically alterable quantity of semi-separated execution environments has become a more widely favored approach to addressing this challenge. Particular examples of resource allocation software include, and are not limited to, Docker offered by Docker, Inc. of Palo Alto, Calif., USA; and Kubernetes offered by the Cloud Native Computing Foundation of San Francisco, Calif., USA. Docker is the simpler one of these two particular offerings, in that it is operable in a “Swarm” mode in which it is capable of dynamically allocating numerous containers. Kubernetes is the more complex of these two particular offerings, in that it dynamically allocates “Pods” that each include one or more containers to support more complex combinations of execution environments.

[0094] While Docker’s Swarm mode has become widely used in simpler applications, Kubernetes has become a de facto choice for resource allocation software as it has proven to be quite capable of supporting the parallelized execution of very large quantities of software routines across numerous computing devices. Unfortunately, experience with

using even relatively sophisticated resource allocation software, such as Kubernetes, has shown that it can be at least difficult to coordinate the actions of instantiating and/or un instantiating containers by such resource allocation software with the commencement and/or completion of execution of routines within those containers. More specifically, in Kubernetes, issues have been encountered with pods being un instantiated while routine(s) are still being executed within a container therein such that their functions may be just partially performed. As will be familiar to those skilled in the art, allowing a software routine to just partially perform its function to an unknown extent by stopping its execution at an unknown point can be worse than simply not allowing a software routine to ever begin performing its function, at all.

[0095] The fact that many of such resource allocation routines are offered as open-source software does present the possibility of making changes to their source code to add the ability to coordinate their dynamic allocation of containers with the state of software routines executed within those containers. In this way, the un instantiation of a container in which a routine is currently being executed might be delayed until that routine has reached the end of its execution therein. Alternatively or additionally, the un instantiation of a container may be coordinated with the cessation of execution of a routine therein at a known point that results in a known state of the function being performed at the time of cessation of execution such that resumption of execution may be more easily resumed. However, it may be deemed desirable to avoid making such changes to the source code of an open source resource allocation routine so as to avoid such issues as the need to repeatedly merge the changes made in new versions thereof with the changes made to add such coordination capabilities. Instead, it may be deemed desirable to address such coordination issues in a manner that more easily allows new versions of a resource allocation routine to be adopted and used.

[0096] There are also other issues that can arise that impair the ability to effectively coordinate the execution of multiple routines across multiple ones of such dynamically allocated containers. Among such issues may be instances of aberrant behavior by the routines, themselves, within the container environments that may be severe enough to cause crashing of a container. Also, hardware malfunctions within computing devices may also occur that may cause unpredictable changes in the execution of a routine within a container and/or a crash of a container. Further, where the computing resources of multiple computing devices interconnected by a network are being centrally managed by a resource allocation routine executed within just one of those multiple computing devices, instances of loss or other impairment of network connections thereamong may cause loss of communications with containers between computing devices.

[0097] To address such a range of issues, one or more routines performing various coordinating functions may be executed within one or more computing devices alongside such resource allocation software as Kubernetes. Such additional routines may establish, maintain and use a set of message queues, where each such message queue links particular subsets of the containers/pods that are dynamically allocated by the resource allocation routine. Within the set of message queues, protocols may be used that enable the preservation of information about the state of execution of various routines among the set of containers/pods. In this

way, aspects of the state of the performances of tasks of job flows implementing MTC may be preserved, along with aspects of the state of the performances of the functions of other routines that serve to coordinate the performances of those tasks. Thus, where an event occurs that causes an uncoordinated cessation of execution of a routine within a container, or that causes the crashing or un instantiation of a container or entire pod, a restarting of execution of another instance of the same routine may be caused within another available container/pod to ensure that the function(s) that were supposed to be performed by that routine are ultimately performed.

[0098] More specifically, a set of coordinating pods may be allocated in which various routines may be executed to support performances of job flows using computing resources that are allocated through the allocation of a set of task pods. Within each coordinating pod and each task pod may be at least one container in which a messaging routine is executed to engage in the exchange through message queues (specifically, through the storing of messages within queues, the reading of messages stored within queues and/or the removal of messages from queues), and another container in which the one of the routines supporting the performance of job flows or one of the task routines may be executed.

[0099] In some embodiments, environment variables may be used to provide the resource allocation software within indications of upper and/or lower limits concerning quantities that are to be maintained of each type of pod. By way of example, minimum and/or maximum quantities of various types of coordinating pod may be so provided to the resource allocation software to ensure that sufficient quantities of such pods are maintained to ensure proper functionality in implementing MTC. Similarly, such minimum and/or maximum quantities may be similarly provided for task pods, and as will shortly be explained, this may be extended to specifying such quantities for each of multiple types of task pod. By way of example, there may be a need to impose an upper limit on the quantity of a particular type of task pod that may be maintained to ensure that a particular limited resource used by that type is not excessively consumed.

[0100] In some embodiments, environment variables may be used to provide an indication to each pod concerning what type of pod it is meant to be. More specifically, as each pod is instantiated, a portion of code and/or of a data structure that defines various aspects of the functionality of that pod may be caused to include a data value indicative of the type of pod. In this way, one or more routines executed within the pod and/or within the container(s) therein may access such a data value to determine the type of pod, and accordingly, determine one or more aspects of its functionality.

[0101] Among the set of coordinating pods may be at least one portal pod in which a routine may be executed to provide a portal on a network that implements a selected applications programming interface (API) and/or other protocol to enable the reception of requests from requesting devices for the performances of job flows. The portal pod(s) may maintain request data (e.g., a database) indicative of individual received requests for the performance of job flows, along with indications of the statuses of those performances and/or indications of the responses to the requests that have been transmitted back to the requesting devices. Also among the

set of coordinating pods may be at least one performance pod in which a routine may be executed that employs the information provided in job flow definitions to coordinate performances of tasks of job flows by task routines executed within the task pods.

[0102] As part of enabling the execution of task routines within each of the task pods, those task routines and any data values required as input may need to be retrieved from one or more federated areas. In some embodiments, each of the task pods may include a third container within which an instance of a resolver routine may be executed to perform the work of searching through one or more federated areas for the task routine that is to be executed within that pod, along with any data objects required as inputs to that task routine. Additionally, in some embodiments, there may be multiple types of task pod that may be differentiated by a difference in features provided to support the execution of task routines therein. By way of example, in embodiments in which the execution of task routines written in a variety of different programming languages is supported, there may be different types of task pod in which each different type supports the execution of a task routine written in a different one of those programming languages. In some of such embodiments, the type of programming language (or the particular combination of programming languages) supported by each task pod may be configured as each task pod is instantiated through the earlier-discussed mechanism of an environment variable incorporated therein.

[0103] A variety of mechanisms may be used in combination to maintain coherency in the storage and retrieval of objects that are both required for, and generated during, the performance of job flows in a many-task computing (MTC) environment implemented in a distributed processing system based on multiple interconnected devices where the underlying file system(s) that are used are not architected to ensure coherency. More specifically, for each job flow, an order of performance of its tasks is derived based on data dependencies thereamong, and that order of performance is used in combination with message queuing to ensure that objects required for the performance of each task have already been generated and/or stored so as to ensure their availability for retrieval from any of multiple devices. Thus, a form of coherency is effectively layered atop the file system(s).

[0104] A form of groundwork for providing such coherency is put in place even before job flows are performed. Across the federated area(s), a set of rules is employed to ensure that, when an object having dependencies on other objects is stored, those other objects have already been stored such that those dependencies are assured of being able to be met. By way of example, a job flow definition may not be permitted to be stored unless and until there is at least one task routine already available in storage to perform each of the tasks that are defined to be part of the corresponding job flow. Similarly, an instance log that documents an instance of performance of a job flow may not be permitted to be stored unless and until each data object and each task routine that it identifies is also already available in storage such that the documented performance is able to be repeated. Correspondingly, objects are not permitted to be removed from federated area(s) unless their continued storage within the federated area(s) is not required by any other object stored within the federated area(s). In this way, there are no

missing objects such that the performance of a job flow is prevented as a result of an unmet dependency.

[0105] Built atop such groundwork, each instance of performance of each job flow begins with a derivation of an order of performance of its tasks based on instances of data dependencies thereamong in which a data object required as an input to a task must first be generated by a preceding task and stored in a federated area to enable its retrieval. This order of performance is then used to control the timing with which the performances of each task is caused to be allocated to a container to be carried out. Further, within each such container, the performance of each task is delayed to the extent necessary for data object(s) required as input(s) to be retrieved from the federated area(s) in which they have been stored, regardless of whether those federated area(s) are maintained locally within the same device in which the container is instantiated, or are maintained within other device(s).

[0106] Multiple message queues may be established and combined into a single queue structure that may be managed by a message broker routine, which may implement the Advanced Message Queuing Protocol (AMQP) promulgated by the Organization for the Advancement of Structured Information Standards (OASIS) of Burlington, Mass., USA. One such message broker may be RabbitMQ offered by Pivotal of San Francisco, Calif., USA. Each message queue may be implemented to function in a manner in which a message is placed on a queue that is intended to be received by one of a particular type of pod in which a particular type of routine is executed, rather than a message that is intended to be received by any one particular individual pod. As will be explained in greater detail, this may allow multiple ones of the same type of pod to listen for the same message, and for whichever one of them that is able to take action in response to the message to reply to the message. This may be one of the approaches taken to provide some degree of resiliency in situations in which one of the pods of a particular type is uninstantiated or otherwise rendered non-functional (e.g., crashes).

[0107] At least a pair of message queues may be established that include a job queue and a task queue. Through the job queue, the portal pod(s) and the performance pod(s) may cooperate to initiate performances of job flows and to exchange status information concerning those performances to ensure the completion thereof in spite of instances of un instantiation of pods and/or other mishaps, as will be described in greater detail. Through the task queue, the performance pod(s) and the task pods may cooperate to ensure the executions of task routines to perform the tasks of each job flow for which a request is received, as will also be described in greater detail. As task routines are successfully executed to perform tasks of a job flow, a performance pod coordinating the performance of that job flow receives messages indicative of those successful completions from those task pods through the task queue. Upon successful completion of the last of the tasks of a job flow, the performance pod may transmit a message conveying an indication of the results of the completion of the job flow to the portal pod to be relayed onward to requesting device.

[0108] It may be that, during such executions of task routines within the task pods, if one of those task pods is unexpectedly un instantiated by the resource allocation routine, crashes and/or suffers some other form of mishap, the performance pod may be apprised of such an event as a

result of ceasing to receive a status indication from that task pod within a predetermined period of time. Alternatively or additionally, the performance pod may be apprised of such an event as a result of the loss of a queue conveying messages from that task pod in embodiments in which the task queue is actually made up of multiple queues, including separate queues that each convey messages from just one of the task pods. Regardless of the exact manner in which the performance pod is apprised of such an event, the performance pod may respond to that event by causing the performance of that task to be re-commenced within another task pod.

[0109] The manner in which an unexpected un instantiation of a performance pod may be handled may be somewhat similar. Upon a new performance pod taking over for the un instantiated one, the new performance pod may analyze the job flow performance request messages on the job queue (regardless of the exact manner in which it is implemented), along with any corresponding response messages to determine what instances of job flow performance are still in progress. The new performance pod may also analyze task performance request messages on the task queue (regardless of the exact manner in which it is implemented), along with any corresponding response messages to determine what instances of task performance are still in progress.

[0110] In some embodiments, and as previously discussed, there may be different types of task pod that may be used in combination, such as different types of task pod to support task routines written in different programming languages, and/or different types of task pod to support task routines that use different combinations of services. In some of such embodiments, there may be multiple different types of task queue that each correspond to one of the different types of task pod. The provision of multiple different types of task queues, at least for conveying messages to multiple task pods, may be deemed a preferred mechanism by which to cause task routines having differing characteristics to be executed within appropriate corresponding types of task pod, and/or to better accommodate differences in the messages used with the different types of task pod and/or used with task routines having such different characteristics.

[0111] As part of enabling the tracking of events associated with the execution of numerous task routines associated with multiple job flows, it may be that each job flow that is to be performed is assigned a unique job flow instance identifier, and/or that each task that is to be performed within each job flow is assigned a unique task instance identifier. As messages concerning the performance of job flows and/or tasks are exchanged among the pods via the message queues, each such message may include at least the job flow instance identifier of that instance of performing the job flow, if not also the task instance identifier of the instance of performing the task that it is associated with. In some of such embodiments, both the job flow instance identifier and the multiple task instance identifiers associated with each instance of performance of a job flow may be centrally assigned by the portal pod that receives the request to perform that job flow. Thus, in such embodiments, it may be that at least the message conveying the request to perform the job flow that is ultimately received and acted upon by a performance pod will contain the task instance identifiers for all of the tasks that are to be performed as part of that instance of performing that job flow. The job flow instance identifier and the complete set of task instance identifiers generated within the

portal pod for an instance of performing a job flow may be stored within the request data (database) accessible across the portal pods, in addition to being conveyed in the request to perform the job flow.

[0112] In some embodiments, sub flow instance identifiers may additionally be assigned to instances of performing sub flows of a job flow. More specifically, within the portal pod, a job flow definition may be analyzed to identify branches, instances in which multiple tasks may be performed in parallel, and/or instances where tasks are limited to being performed sequentially, as an approach to identifying distinct sub flows. It may be that, during an instance of performing a job flow, a request for status may be received by the portal pod. Under particular circumstances, the portal pod may be capable of responding to such a request unassisted. However, under other circumstances, the portal pod may relay the request via the job queue to the performance pod that controls that instance of performance of the job flow. That performance pod may respond by providing that portal pod with a data structure in which each task instance identifier is correlated to a per-task indication of status. The portal pod may match tasks to sub flows, and where possible, may convert indications of status for numerous tasks into single indications of status for sub flows, thereby generating a more compact description of current status for being transmitted to the device from which the status request was received. The possible statuses may include, but not be limited to, “not executed”, “running”, “failed”, “canceled” and/or “completed”.

[0113] In some embodiments, in addition to the aforementioned job and task queues (regardless of whether there is a single task queue or multiple task queues), at least one task kill queue may also be established and managed by the message broker routine. Additionally, among the set of coordinating pods may be at least one kill pod in which a kill routine may be executed in a container thereof that responds to various indications of trouble in the execution of a task routine within a task pod by triggering the cessation of the associated job flow.

[0114] More specifically, it may be that the kill routine recurrently receives messages via the kill queue from each of the task pods in which a task routine is being executed. Such recurring messages from each of the task pods may provide a form of “heartbeat” signal that confirms that each task pod still includes a container in which a task routine is still being successfully executed. Alternatively or additionally, such recurring messages from each of the task pods may provide various pieces of information concerning the execution of a task routine therein, including and not limited to, types of operations being performed as a result of the execution of the task routine, types of messages being sent and/or received through one or more queues, levels of various resources (e.g., processing resources, storage resources and/or communications resources) being consumed by the execution of the task routine, and/or failure of the execution of the task routine (e.g., crashing).

[0115] Where messages are received at the kill pod that are consistent with ongoing successful execution of a task routine within a task pod such that there are no messages received that indicate excessive consumption of a resource, excessive execution time, and/or the occurrence of a crash of the task routine, the kill routine within the kill pod may take no action concerning the execution of that task routine within that task pod. However, in response to one or more

messages being received at the kill pod that are consistent with aberrant behavior by the task routine during its execution, and/or failure of execution of the task routine, the kill routine may transmit one or more messages to trigger the un instantiation of the task pod in which the task routine is being executed. In so doing, the kill routine may also trigger the cessation of the job flow for which the task routine was being executed.

[0116] More specifically, upon receiving the message via the kill queue that commands un instantiation of the task pod, the task pod may transmit an indication to the performance pod, via the task queue, that attempts at executing the task routine were unsuccessful before un instantiating itself. In response, the performance pod may effectuate the cessation of any further performance of any of the tasks of the job flow that included the execution of that task routine, and may transmit an indication to the portal pod via the job queue of the performance of the job flow having ended with errors. The portal pod may, in turn, relay such an indication onward to the requesting device. As will also be explained in greater detail, an instance of a task pod un instantiating itself and/or a container therein may trigger the resource allocation routine to instantiate a new task pod to replace it.

[0117] As will be explained in greater detail, the kill routine may enforce a rule in which a task routine is allowed to crash up to a predetermined maximum number of times before the task routine is deemed incapable of being successfully executed such that it is deemed necessary to trigger the un instantiation of that task pod, and accordingly, trigger the cessation of the associated job flow. As will also be explained in greater detail, the kill routine may enforce one or more limitations on the consumption of resources, the consumption of time, the range of behaviors, and/or other parameters on the execution of a task routine. It may be that the kill routine enforces a rule in which the execution of a task routine that exceeds one or more of such parameters results in the task routine being deemed incapable of being successfully executed such that it is deemed necessary to trigger the un instantiation of that task pod, and accordingly, trigger the cessation of the associated job flow.

[0118] The provision of such an ability to detect and respond to situations in which the execution of a task routine has failed and/or is proceeding in a way that exceeds one or more parameters of expected behavior may serve as another approach to mitigating the possibility of an uncoordinated un instantiation of a pod by resource allocation software (e.g., Kubernetes). As those skilled in the art will readily recognize, such resource allocation software is necessarily reactive in nature, relying on its observations of various aspects of the manner in which routines are executed within pods such that one or more pods may be un instantiated in an uncoordinated manner as a reaction to a change in the degree of utilization of one or more resources without any understanding of what is causing such a change. Thus, it may be that a pod in which the execution of a routine is underway without any mishap may be un instantiated in response to a rise in the consumption of a resource caused by the failing execution of another routine underway in another pod. By identifying situations in which the execution of at least task routines may have gone wrong within a pod, and causing the un instantiation of that particular pod and/or the cessation of the performance of its associated job flow, it may be possible to cause the un instantiation of the pod in which trouble in the execution of task routine is occurring quickly enough to

avoid having the resource allocation software being triggered to unstantiate another pod in which a task routine or other routine was being successfully executed without mishap.

[0119] In some embodiments, in addition to the aforementioned job queue, task queue and task kill queue, at least one job kill queue may also be established and managed by the message broker routine. Through the task kill queue, one of the portal pod(s) and the task pods that are executing task routines to perform the tasks of a particular job flow may cooperate to stop the performance of that job flow. More specifically, a portal pod may relay, through the task kill queue, and to all of the task queues, a request received from a requesting device to stop the performance of all tasks associated with that particular job flow. The ones of the task pods that are involved in performing the tasks of the job flow will each individually recognize the message as being pertinent to them. Each of such task pods may transmit a message to the performance pod, via the task queue, indicating that execution of the task routine that was being executed within it has stopped, and for the reason of a received cancellation request. Following the transmission of such a message, each such task pod may unstantiate itself, thereby triggering the resource allocation routine to replace it by instantiating a new task pod. In response to receiving such messages of cancellation of the performance(s) of one or more tasks of the particular task routine, the performance pod that was coordinating the performance of the tasks of that job flow may cease to cause any more of the tasks of that job flow to be executed, and may transmit a message acknowledging the cancellation of the job flow to portal pod to be relayed back to the device from which the cancellation request was received.

[0120] It should be noted that, either as a portal pod transmits the message to end the performance of the job flow onto the job kill queue, that same portal pod may also transmit the same message onto the job queue, and then refrain from retrieving that message from the job queue until it has updated the indications of the status the job flow stored within the database to indicate that the job flow is to be cancelled. In this way, if the particular portal pod becomes unstantiated before the message indicating that the job flow has indeed been cancelled is received via the execution queue from a performance pod, such a status indication in the database will spur another portal pod to take over the work of ensuring that the cancellation takes place and/or of notifying the requesting device when that cancellation has happened.

[0121] As still another approach to mitigating the possibility of an uncoordinated unstantiation of a pod by resource allocation software, indications may be provided, on a recurring basis, to the resource allocation software to provide preemptive indications of changing resource needs. This may done to guide the resource allocation software toward preemptively preparing for upcoming changes in resource needs, thereby avoiding situations in which the manner in which resources are consumed does not match the manner of consumption of resources that was previously prepared for such that excessive consumption of a resource results that triggers the resource allocation software to unstantiate a pod in uncoordinated manner. More specifically, in this way, the resource allocation software may be preemptively provided within an indication of the need to change the quantities of one or more types of pod, either

prior to or coincident with a change in consumption of resources, rather than allow the resource allocation software to wait until such changes in consumption resources has already occurred need such that the resource allocation software is prompted to take action as a reaction to such changes.

[0122] As previously discussed, and again by way of example, there may be different types of task pod that may be used in combination, such as different types of task pod to support task routines written in different languages, and/or different types of task pod to support task routines that use different combinations of services. In such an embodiment, there may occasionally be a need to alter the relative quantities of the different types of task pod as the particular combination of task routines that are executed change throughout the performance of one or more job flows. By way of another example, a change in the quantity of job flows that are to be performed at least partially in parallel may necessitate a need for changes in the relative quantities of task pods versus performance pods and/or portal pods.

[0123] In some embodiments, a relatively lengthy period of time may be required by the resource allocation software to instantiate a particular type of pod when there isn't already at least one of that type of pod already instantiated. Therefore, as a measure to at least limit the occasions on which such a lengthy time period must be incurred, there may be a hysteresis or other form of delay imposed on providing the resource allocation software with an indication that none of a particular type of pod will be needed such that the unstantiation of all of that type of pod is caused to take place. Instead, there may be an initial indication provided to the resource allocation software that only one of the particular type of pod is needed, before providing an indication that none are needed after a pre-selected delay.

[0124] In some embodiments, it may be that, in addition to the resource allocation software, virtual machine (VM) allocation software is also used to distribute processing, storage, and/or other resources to support MTC. Particular examples of VM allocation software include, and are not limited to, VMware offered by VMware, Inc., of Palo Alto, Calif., USA; Red Hat Virtualization offered by Red Hat, Inc. of Raleigh, N.C., USA; and Azure Virtual Machine offered by Microsoft Corporation of Redmond, Wash., USA. Thus, the VM allocation software that allocates resources through allocation of VMs may be separate and distinct from the resource allocation software that allocates resources through allocation of containers and/or pods.

[0125] The VM allocation software may be employed to implement greater separation between implementations of MTC associated with different users and/or different groups of users. Alternatively or additionally, the VM allocation software may be employed to provide a mechanism by which amounts of processing and/or storage resources may be dynamically assigned to users and/or groups of users in an "on demand" basis to support changing workloads for each user or group of users, including MTC workloads. This may be part of a system for providing processing resources at varying levels to satisfy the varying needs of customers as part of providing a more cost-effective access to computing resources in which the prices paid or more closely associated with computing resources that are actually used.

[0126] This results in the creation of a dual-layered combination of resource allocation mechanisms based on using two separate pieces of software together. Instead of the

resource allocation software allocating pods and/or containers based on what physical computing devices are available and/or what resources are available from each physical computing device, the resource allocation software is caused to allocate pods and/or containers based on what VMs are available and/or what resources are available from each VM. As part of implementing support for “on demand” increases and/or decreases in the quantity of VMs that are provided to each user and/or group of users, the VM allocation software may also be preemptively provided, on an ongoing basis, with indications of upcoming expected levels of demand for processing resources. Such indications may simply be the provision of the same indications of quantities of pods that are expected to soon be needed, where such quantities of pods may be automatically translated into corresponding quantities of VMs. Alternatively, such indications may include indications of quantities of VMs that are expected to soon be needed.

[0127] The ability of the resource allocation software to detect changes in availability of VMs and/or changes in levels of availability of resources may be relied upon to enable the addition of another VM to trigger the addition of one or more new pods and/or containers to make use of the resources provided by the added VM. More specifically, where both the resource allocation software and the VM allocation software are signaled to support the execution of more task routines in parallel through the provision of more pods and/or containers, and more VMs, the VM allocation software may instantiate or otherwise make available another VM, and the resource allocation software may respond to the addition of that VM by instantiating one or more additional pods and/or containers within that additional VM. Alternatively or additionally, it may be that a delay of a pre-selected period of time is imposed after the VM allocation software is signaled to increase the allocation of VMs, and before the resource allocation software is signaled to increase the allocation of containers as part of a mechanism to allow some amount of time for the provision of more VMs before more containers are instantiated.

[0128] In some embodiments, actions required to instantiate new VMs, unstantiate existing VMs, and/or transfer existing VMs from another user or group of users may require more time to carry out than either the instantiation or un instantiation of pods and/or containers. Therefore, in a manner similar to the responses by the resource allocation software to preemptive indications to decrease the quantity of pods and/or containers, there may be a hysteresis or other form of delay imposed on the responses by the VM allocation software to preemptive indications to decrease the overall quantity of VMs (or the quantity of a particular type of VMs). Such use of a degree of hysteresis in preemptively reducing quantities of VMs may serve to mitigate delays in making another VM available that may arise as a result of wildly fluctuating need for VMs causing a VM to become unavailable within all too short a period of time before it is needed, again.

[0129] The use of such a hysteresis in handling preemptive indications to decrease the quantity of VMs may be employed in controlling the order in which the quantity of pods and/or containers are reduced and in which the quantity of VMs is reduced. More specifically, where it is determined that fewer resources will soon be needed to support parallel executions of task routines, it may be deemed desirable to cause a reduction in pods and/or containers to occur before

causing the corresponding reduction in VMs to occur. Therefore, it may be that the degree of hysteresis for causing such reduction in VMs to occur may be selected to cause the reduction in VMs to occur after the reduction in pods and/or containers.

[0130] The storage of objects (e.g., data objects, task routines, macros of task routines, job flow definitions, instance logs of past performances of job flows, and/or DAGs of task routines and/or job flows) may be effected using a grid of devices. Such a grid may provide distributed storage for data objects that include large data sets, complex sets of task routines for the performance of various analyses divided into tasks specified in job flows, and/or instance logs that document an extensive history of past performances of such analyses. Such distributed storage may be used to provide one or both of fault tolerance and/or faster access through the use of parallelism. In various embodiments, the objects stored within a federated area or a set of federated areas may be organized in any of a variety of ways that may employ any of a variety of indexing systems to enable access. By way of example, one or more databases may be defined by the one or more federated devices to improve efficiency in accessing data objects, task routines and/or instance logs of performances of analyses.

[0131] In some embodiments, the grid of devices may be a grid of federated devices that internally provide storage spaces within which federated area(s) may be defined for the storage of objects. Alternatively, the federated devices of such a grid may each be coupled to one or more storage devices that are operated under the control of the grid of federated devices. In such embodiments, each of the federated devices may provide the processing resources by which various operations may be performed in association with the objects. In other embodiments, the grid of devices may be a grid of storage devices within which federated area(s) may be defined for the storage of objects. In such embodiments, each of the storage devices may provide at least some degree of processing resources that may be of lesser capability than the processing resources of the federated device(s), but may still be sufficient for use in performing at least some limited range of operations in association with the objects.

[0132] Regardless of the type of device used to form such a grid, in some embodiments, each of those devices may store whole objects such that each object (including each data object) is stored as a single undivided object within a single storage device, and not stored in a distributed manner across two or more storage devices. In other embodiments, at least data objects that exceed a predetermined threshold size may each be stored in a distributed manner in which each such data object is divided into multiple blocks that are distributed for storage among multiple devices. In still other embodiments, a combination of such approaches may be used in which each object that is smaller than the predetermined threshold size is stored as an undivided object entirely within a single one of the devices, while each object that is larger than the predetermined threshold size is divided into blocks that are stored in a distributed manner across multiple ones of the devices. In some of such grids of devices that enable the storage of objects in a distributed manner, the devices of that grid may cooperate to implement a distributed file system with various data organization features that may fit one or more specific industrial standards. By way of a specific example, the multiple devices of such a grid may cooperate among themselves the HADOOP® distributed file

system (HDFS) promulgated by the Apache™ Software Foundation of Wakefield, Mass., USA.

[0133] The one or more federated devices may define at least some of the storage space provided by the one or more federated devices and/or the one or more storage devices as providing federated area(s) in which the objects are stored and to which access is controlled by the one or more federated devices (or one or more other devices separately providing access control). By way of example, access to a federated area may be limited to one or more particular authorized persons and/or one or more particular authorized entities (e.g., scholastic entities, governmental entities, business entities, etc.). Alternatively or additionally, access to a federated area may be limited to one or more particular authorized devices that may be operated under the control of one or more particular persons and/or entities.

[0134] In embodiments in which at least some objects are to be stored as undivided objects within storage space provided by a single device(s) such that no object is to be stored in a distributed manner across two or more devices, the one or more federated devices may define each federated area to be entirely contained within a single federated device or storage device. Alternatively, at least one federated area may be defined to span two or more federated devices and/or storage devices, but each object stored therein may still be stored as an undivided object within just one of the two or more storage devices. Thus, while there may be one or more federated areas that span multiple devices, there may be no objects stored in a manner that does so. In embodiments in which at least data objects that exceed the predetermined threshold size are each to be stored in a distributed manner in which each such data object is divided into multiple blocks, the one or more federated devices may define at least one federated area to span multiple devices among which the blocks of such a data object may be distributed for storage. Thus, such a data object may be caused to span multiple federated devices and/or storage devices within a single federated area that also does so. In still other embodiments in which a combination of such approaches is to be used, a mixture of federated areas that are contained within a single device and that span multiple devices may be defined. Additionally, at least one federated area that is defined to span multiple devices may store a mixture of objects that are each stored as an undivided object within a single one of the multiple devices and objects that are divided into blocks that are distributed among the multiple devices for storage in a manner that spans the multiple devices.

[0135] In various embodiments, the manner in which a federated area is used may be limited to the storage and retrieval of objects with controlled access, while in other embodiments, the manner in which a federated area is used may additionally include the performances of analyses as job flows using the objects stored therein. In support of enabling at least the storage of objects within one or more federated areas, the one or more federated devices may provide a portal accessible to other devices via a network for use in storing and retrieving objects associated with the performances of analyses by other devices. More specifically, one or more source devices may access the portal through the network to provide the one or more federated devices with the data objects, task routines, job flow definitions, DAGs and/or instance logs associated with completed performances of analyses by the one or more source devices for storage within one or more federated areas for

the purpose of memorializing the details of those performances. Subsequently, one or more reviewing devices may access the portal through the network to retrieve such objects from one or more federated area through the one or more federated devices for the purpose of independently confirming aspects of such the performances.

[0136] As an alternative to or in addition to the provision of such a portal, the one or more federated devices may be caused to repeatedly synchronize the contents of at least a portion of at least one selected federated area with an external storage space maintained by another device in a bidirectional manner, such as another source code repository system (e.g., GitHub™). More specifically, as object(s) within the external storage space of the other device are changed in any of a number of ways (e.g., added, edited, deleted, etc.), corresponding changes may be automatically made to corresponding objects maintained within the federated area to synchronize the contents therebetween. Similarly, as object(s) within the federated area are changed in any of a number of ways, corresponding changes may be automatically made to corresponding objects maintained within the external storage space of the other device, again, to synchronize the contents therebetween.

[0137] Among the objects that may be stored in a federated area may be numerous data objects that may include data sets. Each data set may be made up of any of a variety of types of data concerning any of a wide variety of subjects. By way of example, a data set may include scientific observation data concerning geological and/or meteorological events, or from sensors in laboratory experiments in areas such as particle physics. By way of another example, a data set may include indications of activities performed by a random sample of individuals of a population of people in a selected country or municipality, or of a population of a threatened species under study in the wild. By way of still another example, a data set may include data descriptive of characteristics of one or more neural networks, such as hyperparameters that specify the quantity and/or organization of nodes within the neural network, and/or such as parameters weights and biases of each of the nodes that may have been derived through a training process in which the neural network is trained to perform a function. In some embodiments, a single data set or a set of data sets may include data descriptive of multiple neural networks that are used together in an ensemble to perform a function.

[0138] Regardless of the types of data each such data set may contain, some data sets stored in a federated area may include data sets employed as inputs (or “input data objects”) to the performance of one or more job flows (e.g., flow input data sets), and/or other data sets stored in a federated area may include data sets that are generated as outputs (or “output data objects”) of past performance(s) of one or more job flows (e.g., result reports). It should be noted that some data sets that serve as inputs to the performance of one job flow may be generated as an output of a past performance of another job flow (e.g., a result report becoming an flow input data set). Still other data sets may be both generated as an output and used as input during a single performance of a job flow, such as a data set generated as an output by the performance of one task of a job flow for use by one or more other tasks of that same job flow as an input (e.g., mid-flow data sets).

[0139] Also among the objects that may be stored in a federated area may be a combination of task routines and a

job flow definition that, together, provide a combination of definitions and executable instructions that enable the performance of an analysis as a job flow that is made up of a set of tasks to be performed. More precisely, the executable instructions for the performance of an analysis may be required to be stored as a set of task routines where each task routine is made up of executable instructions to perform one of the tasks of the analysis. Along with the set of task routines, a job flow definition may also be required to be stored that specifies aspects of how the set of task routines are executed together to perform the analysis, including identifying what tasks are to be performed and the data dependencies among those tasks.

[0140] As will be explained in greater detail, within the job flow definition, the tasks of an analysis that are to be performed may be identified, but not the actual task routines that are to be executed to cause those tasks to be performed. More specifically, within the job flow definition, a set of flow task identifiers may be used that each identify a task that is to be performed, but there may be no task routine identifiers within the job flow definition that uniquely identify any particular task routine to perform any of the specified tasks. By specifying tasks, but not particular task routines, allowance is made for dynamically selecting the version of each task routine that is to be executed to perform one of the specified tasks. In this way, newer versions of task routines that improve upon earlier versions in any of a variety of ways are able to be immediately adopted and used each time the associated job flow is performed. As will also be explained in greater detail, each flow task identifier that identifies a specific task may be correlated by the federated device(s) to the task routine identifiers of each version of task routine that performs the specific task to enable such dynamic selection of task routines.

[0141] It may be that the flow task identifiers are specified within the job flow definition as part of specifying the data dependencies among the tasks. More specifically, the flow task identifiers may be used to indicate which tasks are to receive data object(s) that serve as input(s) to the job flow from external source(s), which tasks are to generate output data object(s) that serve as output(s) of the job flow, and/or which tasks are to receive mid-flow data object(s) that are generated by other task(s) of the job flow. As will be explained in greater detail, although the job flow definition may include such indications of data dependencies among the tasks, the job flow definition may not include identifiers of the actual data objects that may be used as input(s) to a performance of the job flow, and/or that may be generated as output(s) by a performance of the job flow. More specifically, data object identifiers that uniquely identify the data objects, themselves, may not be specified in the job flow definition. In this way, the job flow is made more easily usable with any of a variety of data objects that may be specified as parameters when a performance of the job flow is requested.

[0142] In addition to specifying tasks to be performed and data dependencies among the specified tasks, the job flow definition may also include specifications of input interface (s) by which each task may receive a data object as input, and/or specifications of output interface(s) by which each task may output a data object that it generates. Such specifications may include the specification of data types, data size, data format, data structure, data encoding, etc. In some embodiments, such specifications of input and/or output

interfaces may enable a degree of error checking to ensure that a data object that is to be output through an output interface of one task is able to be accepted as an input through an input interface of another task. As will be explained in greater detail, it may be required that compatibility of interfaces be maintained between versions of task routines that are to perform the same task as part of ensuring the ability to use different versions thereof to perform that task.

[0143] Such breaking up of an analysis into a job flow made up of tasks performed by the execution of task routines that are stored in federated area(s) may be relied upon to enable code reuse in which individual task routines may be shared among the job flows of multiple analyses. Such reuse of a task routine originally developed for one analysis by another analysis may be very simply effected by specifying the flow task identifier of the corresponding task in the job flow definition for the other analysis. Additionally, reuse may extend to the job flow definitions, themselves, as the availability of job flow definitions in a federated area may obviate the need to develop of a new analysis routine where there is a job flow definition already available that defines the tasks to be performed in an analysis that may be deemed suitable. Thus, among the objects that may be stored in a federated area may be numerous selectable and reusable task routines and job flow definitions.

[0144] During runtime of the analysis, the one or more data objects specified in a request to perform the analysis may be retrieved for use as inputs thereto, and the job flow definition may for the performance of the analysis as a job flow may also be retrieved. The job flow definition may then be parsed to retrieve the flow task identifiers therefrom to be used to select and retrieve a version of task routine to perform each task specified by one of the flow task identifiers. The job flow definition may also be parsed to analyze the indications of data dependencies therein to derive an order of performance of the tasks, which may include identifying any opportunities that may exist to perform at least some of the tasks at least partially in parallel.

[0145] As will also be explained in greater detail, there may be various differing ways in which dependencies among tasks may be expressed within a job flow. In one approach, there may be a requirement that, for each instance of an object being exchanged between two tasks, the job flow definition must include an explicit indication of one task generating the data object at an output interface thereof, and an explicit indication of the other task receiving that same data object at an input interface thereof. However, in some embodiments, there may be some degree of allowance for a simpler approach to specifying an exchange of a data object between two tasks in which the task that generates the object at an output interface thereof is, itself, explicitly indicated to be the object that is to be received at an input of the other task. In essence, in this other approach, the task that generates the data object is referred to as if it, itself, were the data object that is received by the other task.

[0146] In various embodiments, a job flow definition may be augmented with graphical user interface (GUI) instructions that are to be executed during a performance of the job flow that it defines to provide a GUI that provides a user an opportunity to specify one or more aspects of the performance of the job flow at runtime. By way of example, such a GUI may provide a user with an opportunity to select one or more data objects to be used as inputs to that performance,

to select which one of multiple versions of a task routine is to be used to perform a task, and/or select a federated area into which to store a result report to be output by that performance. In so doing, the GUI may include instructions to display lists of objects, characteristics of objects, DAGs of objects, etc. in response to specific inputs received from a user.

[0147] In some of such embodiments, the source device that provides such an augmented job flow definition to the one or more federated devices for storage may enable a user to author such GUI instructions through use of a sketch input user interface. More specifically, such a source device may support the entry of GUI instructions as graphical symbols sketched by a user of the source device through a touch-screen user interface device that supports sketch input and a stylus. Such a source device may maintain a library of graphical symbols that are each correlated to a particular type of object, to a particular characteristic of an object and/or to the displaying of particular information in connection to a particular type of object. Alternatively or additionally, such a library may include graphical symbols that are correlated to particular types of user input that is to be awaited and/or to particular types of actions to be taken in response to the receipt of particular types of user input. One or more of such graphical symbols may include human readable text that may be employed to specify distinct pages of a GUI and/or to specify particular objects. Such a source device may interpret the graphical symbols, any text incorporated therein, and/or the manner in which those graphical symbols are arranged relative to each other in the sketch input to derive and generate the GUI instructions with which a job flow definition is to be augmented.

[0148] Although an analysis routine may be implemented as a single job flow that defines a set of tasks to be performed in a specified order, it may be deemed desirable to implement a relatively large and/or complex analysis routine as multiple job flows that are, themselves, performed in a specified order. More precisely, it may be deemed desirable for a relatively large and/or complex analysis routine to be developed as multiple job flows to enable the development effort to be distributed among multiple developers and/or teams of developers, with the intention to combine the multiple job flows into a single “superset” job flow once such a distributed development effort is completed. The multiple job flows to be combined into such a superset job flow may have been previously performed in a particular temporal order, starting with one or more preexisting data objects being provided to the first one(s) of the multiple job flows to be performed (i.e., the input job flow(s)). The performance(s) of those first one(s) of the multiple job flows may, in turn, have generated one or more data objects that were subsequently been used directly as inputs to other(s) of the multiple job flows, and so on following the temporal order, until one or more of the multiple job flows were performed that generated one or more data objects that were directly provided to a last job flow among the multiple job flows that directly generated the particular output data object (i.e., the output job flow).

[0149] Alternatively, it may be that a superset job flow arises more organically as a result of different developers or teams of developers having minimal connection with each other independently developing each of multiple job flows

that, at a subsequent time, are determined to be capable of being combined to implement a relatively large and/or complex analysis.

[0150] Regardless of what the exact motivation and/or circumstances may be for the development of a superset job flow, the ability for a data set output by the performance of one job flow to be used as an input to a subsequent performance of another job flow serves to enable the formation of a superset job flow. In such a superset job flow, at least a portion of each job flow of the set of job flows from which the superset job flow is derived may be caused to be specified to be performed together in an order that is based on dependencies thereamong that arise from each instance in which an output data object generated by the performance of one of the job flows becomes an input data object to the performance of another of the job flows. Thus, the job flow definition of such a superset job flow may be generated by combining information from the job flow definitions of each of the job flows of the set of job flows. The job flow definition for the superset job flow may then simply be stored in a federated area to enable access to it, and thereby, enable the performance of the superset job flow.

[0151] In such a superset job flow, each job flow therein that outputs a data object that is not also used as an input to one of the other job flows therein may be designated an output job flow. Correspondingly, each job flow therein that uses a job data object as an input that is not generated by one of the other job flows therein may be designated an input job flow. Due to dependencies among the job flows within a superset job flow, it is expected that input job flows would precede output job flows in the order in which they are to be performed, though an exception is possible where a job flow therein is both an input job flow and an output job flow.

[0152] Once so derived, the superset job flow may then be used in place of the multiple job flows to either repeat the generation of the particular output data object or to generate other similar output data objects, thereby reducing the number of distinct job flows that must be explicitly requested be performed to accomplish the generation of the same output. The automation of the derivation of the superset job flow may enable personnel with little or no programming skills to nonetheless cause the superset job flow to be derived from at least a portion of each of the multiple job flows. More precisely, the job flow definition that defines the superset job flow is derived based on at least a portion of the job flow definitions that define each of the multiple job flows.

[0153] The derivation of the superset job flow may begin with the receipt, by one or more federated devices, of a request to so derive it, where the request may employ different object identifiers to explicitly identify different ones of the output job flow, the particular output data object and/or the past performance of the output job flow by which the particular output data object was originally generated. More specifically, the one or more federated devices may receive a request to generate the job flow definition for such a superset job flow in which the particular output data object is identified, and may use the data object identifier of that output data object to identify an instance log documenting the particular past performance of the output job flow by which the output data object was directly generated, and thereby identify the output job flow of the particular past performance. Alternatively, the one or more federated devices may receive a request to generate the job flow

definition for such a superset job flow in which the output job flow is identified, and may use the job flow identifier of the output job flow to identify instance log(s) documenting one or more past performances of the output job flow from which a selection of the particular past performance may be prompted to be made, which would thereby identify the particular output data object.

[0154] Regardless of the exact manner in which the particular output data object, the output job flow and/or the particular past performance of the output job flow that generated the particular output data object are identified in the request, the one or more federated devices may perform the derivation of the superset job flow in a manner that proceeds through the multiple job flows in the reverse of the order in which they were performed to generate the particular output data object. Thus, the derivation of the superset job flow may begin by analyzing aspects of the past performance of the output job flow (which again, would have occurred last) to identify which of one(s) of the other job flows among the multiple job flows were performed at a time immediately preceding the performance of the output job flow to directly provide the output job flow with data object(s) that were directly needed as inputs to the performance of the output job flow. Then, aspects of the past performance(s) of each of the preceding job flow(s) that were performed to directly provide input(s) to the output job flow are similarly analyzed to identify any of the multiple job flows that were performed at a still earlier time to provide input(s) to the job flow(s) that directly provided input(s) to the output job flow. Such a process of proceeding in reverse order through the performances of the multiple job flows, starting with the output job flow, continues until each job flow of the multiple job flows is identified so that at least a portion of each may then be incorporated into the superset job flow.

[0155] More specifically, the one or more federated devices may begin the automated derivation of the superset job flow by analyzing the output job flow to identify portion(s) thereof that were not required in the particular past performance to generate the particular output data object, and may prune those portion(s) to derive a pruned form of the output job flow to be included in the superset job flow. The one or more federated devices may then use indications of one or more input data objects that were directly used in the particular past performance as inputs to the pruned form of the output job flow to generate the particular output data object to identify one or more preceding job flows by which each of those one or more input data objects may have been generated. The one or more federated devices may then analyze each of the one or more preceding job flows to identify portion(s) of each that were not required to generate those one or more input data objects, and may prune those portion(s) to derive a pruned form of each to also be included in the superset job flow. The one or more federated devices may then use indications of one or more input data objects to the pruned form of each of those one or more preceding job flows to identify still more preceding job flows, and so on, until no further preceding job flows are able to be identified from which pruned forms may be derived for inclusion in the superset job flow. In this way, the superset job flow may be formed starting with the last task of the output job flow that was the last of the multiple job flows to be performed to generate the particular output

data object, and proceeding towards the earliest task(s) to be performed within the one(s) of the multiple job flows to be performed first.

[0156] The response to a request to derive such a superset job flow may include the provision of a visual representation of the superset job flow. Such a visual representation may include indications of aspects of the output job flow and each of the preceding job flows, and/or what portions of each may have been pruned as part of deriving the superset job flow. In some embodiments, it may be that such a visual representation of the superset job flow is part of a series of visual representations that may be generated to provide a step-by-step visual presentation of the identification and/or pruning of the output job flow and/or of each preceding job flow. Alternatively or additionally, it may be that such a visual representation of the superset job flow is provided as part of a graphical user interface (GUI) of a graphical editor that may enable the superset job flow to be manually modified, following its derivation, to undo at least some of the pruning that has been performed and/or to make still other changes. As with the automation of the derivation of the superset job flow, such a graphical presentation of the superset job flow may further aid personnel with little or no programming skills in the development of such a new job flow by affording such personnel an opportunity to understand various aspects of the superset job flow that they have just caused to be created. Where such a visual presentation is made as part of a GUI for a graphical editor, the graphical presentation of the newly derived superset job flow may provide an advantageous starting point for what may be some relatively minor additional modifications to impart particular desired characteristics to the superset job flow.

[0157] The extent to which preceding job flows may be identified for inclusion within the superset job flow (either in a pruned form or without pruning) may be limited by what job flows have been stored within the one or more federated areas maintained by the one or more federated devices. Stated differently, if a job flow was performed externally on another device to generate a data object that served as an input data object to the past generation of the particular output data object, and if that externally generated input data object is provided to the one or more federated devices for storage, but not the job flow definition of that externally performed job flow, then information needed to include that externally performed job flow in the superset job flow is simply not available to the one or more federated devices.

[0158] Alternatively or additionally, the extent to which preceding job flows may be identified for inclusion within the superset job flow may be limited by what federated areas are authorized to be accessed as part of searching for preceding job flows. More specifically, the particular personnel originating the request and/or the requesting device from which the request is received may be associated with an authorization to access a particular defined set of one or more particular federated areas. Where an indication is found of there being another preceding job flow for which the job flow definition is not accessible due to lack of authorization to access the federated area within which it is stored, the visual representation of the superset job flow may be generated to include an indication that one or more additional preceding job flows do exist, but are unable to be included in the superset job flow due to lack of authorization to access their job flow definition(s). Such an indication may

additionally include contact information by which a request may be made to obtain the necessary authorization.

[0159] Such limitations on authorization to access a job flow definition of a preceding job flow may be at least partially based on the location, within a hierarchy of federated areas, of each federated area to which authorization is granted. Alternatively or additionally, where the requesting device is associated with an alternate development environment with which objects area shared through the use of synchronized transfer areas, such limitations on authorization to access a job flow definition of a preceding job flow may be at least partially based on the location, within a hierarchy of federated areas, of each federated area in which one of such a synchronized transfer area has been defined. Also where the requesting device is associated with an alternate development environment in which a secondary programming language other than the primary programming language usually associated with federated areas is used, the job flow definition of the superset job flow, and/or the objects required to derive and/or provide a visual representation of the superset job flow, may be translated between such languages.

[0160] In some embodiments, a job flow definition may be stored within federated area(s) as a file or other type of data structure in which the job flow definition is represented as a DAG (directed acyclic graph). Alternatively or additionally, a file or other type of data structure may be used that organizes aspects of the job flow definition in a manner that enables a DAG to be directly derived therefrom. Such a file or data structure may directly indicate an order of performance of tasks, or may specify dependencies between inputs and outputs of each task to enable an order of performance to be derived. By way of example, an array may be used in which there is an entry for each task routine that includes specifications of its inputs, its outputs and/or dependencies on data objects that may be provided as one or more outputs of one or more other task routines. Thus, a DAG may be usable to visually portray the relative order in which specified tasks are to be performed, while still being interpretable by federated devices and/or other devices that may be employed to perform the portrayed job flow. Such a form of a job flow definition may be deemed desirable to enable an efficient presentation of the job flow on a display of a reviewing device as a DAG. Thus, review of aspects of a performance of an analysis may be made easier by such a graphical representation of the analysis as a job flow.

[0161] Regardless of whether the DAG is saved for use as a job flow definition, or simply to retain the DAG for future reference, the DAG may be stored as a script generated in a process description language such as business process model and notation (BPMN) promulgated by the Object Management Group of Needham, Mass., USA.

[0162] The tasks that may be performed by any of the numerous tasks routines may include any of a variety of data analysis tasks, including and not limited to searches for one or more particular data items, and/or statistical analyses such as aggregation, identifying and quantifying trends, subsampling, calculating values that characterize at least a subset of the data items within a data object, deriving models, testing hypothesis with such derived models, making predictions, generating simulated samples, etc. The tasks that may be performed may also include any of a variety of data transformation tasks, including and not limited to, sorting operations, row and/or column-based mathematical operations,

filtering of rows and/or columns based on the values of data items within a specified row or column, and/or reordering of at least a specified subset of data items within a data object into a specified ascending, descending or other order. Alternatively or additionally, the tasks that may be performed by any of the numerous task routines may include any of a variety of data normalization tasks, including and not limited to, normalizing time values, date values, monetary values, character spacing, use of delimiter characters and/or codes, and/or other aspects of formatting employed in representing data items within one or more data objects. The tasks performed may also include, and are not limited to, normalizing use of big or little Endian encoding of binary values, use or lack of use of sign bits, the quantity of bits to be employed in representations of integers and/or floating point values (e.g., bytes, words, doublewords or quadwords), etc. Also alternatively or additionally, the tasks that may be performed may include tasks to train one or more neural networks for use, tasks to test one or more trained neural networks, tasks to coordinate a transition to the use of one or more trained neural networks to perform an analysis from the use of a non-neuromorphic approach to performing the analysis, and/or tasks to store, retrieve and/or deploy a data set that specifies parameters and/or hyper parameters of one or more neural networks. By way of example, such tasks may include tasks to train, test, and/or coordinate a transition to using, an ensemble of neural networks such as a chain of neural networks.

[0163] By way of example, tasks that may be performed may include the training, testing, and/or use of a chain of neural networks to generate time series predictions. Each neural network of such a neural network chain may be trained, and then used, to provide a portion of the time series prediction that covers a different subrange of time that make up the full range of time covered by the time series prediction. The neural networks may be interconnected such that each neural network in the neural network chain may receive, as a subset of its inputs, the outputs of each of the preceding neural networks by which each of those preceding neural networks provide their portion of the time series prediction. The neural networks may be trained, one at a time, starting with the first neural network in the chain. To reduce overall training time, a form of transferred learning may be employed in which each neural network, as a starting point for its training, is provided with the weights and biases representing what was learned by the preceding neural network.

[0164] The set of tasks that may be specified by the job flow definitions may be any of a wide variety of combinations of analysis, normalization and/or transformation tasks. The result reports generated through performances of the tasks as directed by each of the job flow definitions may include any of a wide variety of quantities and/or sizes of data. In some embodiments, one or more of the result reports generated may contain one or more data sets that may be provided as inputs to the performances of still other analyses, and/or may be provided to a reviewing device to be presented on a display thereof in any of a wide variety of types of visualization. In other embodiments, each of one or more of the result reports generated may primarily include an indication of a prediction and/or conclusion reached through the performance of an analysis that generated the result report as an output.

[0165] Additionally among the objects that may be stored in a federated area may be numerous instance logs that may each provide a record of various details of a single past performance of a job flow. More specifically, each instance log may provide indications of when a performance of a job flow occurred, along with identifiers of various objects stored within federated area(s) that were used and/or generated in that performance. Among those identifiers may be an identifier of the job flow definition that defines the job flow of an analysis that was performed, identifiers for all of the task routines executed in that performance, identifiers for any data objects employed as an input (e.g., input data sets), and identifiers for any data objects generated as an output (e.g., a result report that may include one or more output data sets).

[0166] The one or more federated devices may assign such identifiers to data objects, task routines and/or job flow definitions as each is stored and/or generated within a federated area to enable such use of identifiers in the instance logs. In some embodiments, the identifier for each such object may be generated by taking a hash of at least a portion of that object to generate a hash value to be used as the identifier with at least a very high likelihood that the identifier generated for each such object is unique. Such use of a hash algorithm may have the advantage of enabling the generation of identifiers for objects that are highly likely to be unique with no other input than the objects, themselves, and this may aid in ensuring that such an identifier generated for an object by one federated device will be identical to the identifier that would be generated for the same object by another device.

[0167] Where task routines are concerned, it should be noted that the unique identifier generated and assigned to each task routine is in addition to the flow task identifier that identifies what task is performed by each task routine, and which are employed by the job flow definitions to specify the tasks to be performed in a job flow. As will be explained in greater detail, for each task identified in a job flow definition by a flow task identifier, there may be multiple task routines to choose from to perform that task, and each of those task routines may be assigned a different identifier by the one or more federated devices to enable each of those task routines to be uniquely identified in an instance log. Where instance logs are concerned, the identifier assigned to each instance log may, instead of being a hash taken of that instance log, be a concatenation or other form of combination of the identifiers of the objects employed in the past performance that is documented by that instance log. In this way, and as will be explained in greater detail, the identifier assigned to each instance log may, itself, become useful as a tool to locating a specific instance log that documents a specific past performance.

[0168] The assignment of a unique identifier to each object (or at least an identifier that is highly likely to be unique to each object) enables each object to be subsequently retrieved from storage to satisfy a request received by a federated device to access one or more specific objects in which the request specifies the one or more specific objects by their identifiers. Alternatively, requests may be received to provide access to multiple objects in which the multiple objects are specified more indirectly. By way of example, a request may be received to provide access to a complete set of the objects that would be needed by the requesting device to perform a job flow with specified data set(s) serving as

inputs, where it is the job flow definition and the data set(s) that are directly identified in the request. Responding to such a request may entail the retrieval of the specified job flow definition and the specified data set(s) by the one or more federated devices, followed by the retrieval of the flow task identifiers for the tasks to be performed from the job flow definition, followed by the use of the flow task identifiers to retrieve the most current version of task routine to perform each task, and then followed by the transmission of the specified job flow definition, the specified data set(s) and the retrieved task routines to the requesting device. By way of another example, a request may be received to provide access to the objects that are identified by an instance log as having been employed in a past performance of a job flow, where it is the instance log that is directly identified by its identifier in the request. Responding to such a request may entail the retrieval of the specified instance log by one or more federated devices, followed by the retrieval of the identifiers of other objects from that instance log, and then followed by the retrieval and transmission of each of those other objects to the device from which the request was received. As will be explained in greater detail, still other forms of indirect reference to objects stored within federated area(s) may be used in various requests.

[0169] In various embodiments, the use of federated area (s) may go beyond just the storage and/or retrieval of objects, and may include the use of those stored objects by the one or more federated devices to perform job flows. In such embodiments, the one or more federated devices may receive requests (e.g., via the portal) from other devices to perform various analyses that have been defined as job flows, and to provide an indication of the results to those other devices. More specifically, in response to such a request, the one or more federated devices may execute a combination of task routines to perform tasks of a job flow described in a job flow definition within a federated area to thereby perform an analysis with one or more data objects, all of which are stored in one or more federated areas. In so doing, the one or more federated devices may generate an instance log for storage within a federated area that documents the performances of the analysis, including identifiers of data objects used and/or generated, identifiers of task routines executed, and the identifier of the job flow definition that specifies the task routines to be executed to perform the analysis as a job flow.

[0170] In some of such embodiments, the one or more federated devices may be nodes of a grid of federated devices across which the tasks of a requested performance of an analysis may be distributed. The provision of a grid of the federated devices may make available considerable shared processing and/or storage resources to allow such a grid to itself perform complex analyses of large quantities of data, while still allowing a detailed review of aspects of the performance of that analysis in situations where questions may arise concerning data quality, correctness of assumptions made and/or coding errors. During the performance of a job flow, the one or more federated devices may analyze the job flow definition for the job flow to identify opportunities to perform multiple tasks in parallel based on dependencies among the tasks in which data generated as an output by one task is needed as an input to another. Such opportunities for parallel performances may be utilized as opportunities to more thoroughly spread the performances of

the multiple tasks among more processor threads and/or cores, among more processors and/or among more federated devices.

[0171] However, it should be noted that other embodiments are possible in which each of the multiple storage devices may incorporate sufficient processing resources to enable at least a subset of job flows to be performed by the multiple storage devices in addition to and/or in lieu of the one or more federated devices doing so. In some of such embodiments, whether the processing resources of the one or more federated devices are employed to perform a particular job flow or the processing resources of multiple storage devices are employed to do so may be determined based on a variety of aspects associated with the manner in which one or more of the objects needed to perform the job flow are stored. At least in the case of data objects used as inputs, such aspects may include, and are not limited to, which federated area each such data object is stored within, which federated device(s) and/or storage device(s) each such data object is stored within, the size of such data objects, whether such data objects are stored in an undivided manner or a distributed manner, and/or whether such data objects that are stored in a distributed manner are in a distributable form.

[0172] The one or more federated devices may store a set of indications of such aspects of storage for each object stored within a federated area. In some embodiments, the one or more federated devices may generate a separate object location identifier for each object in addition to or in lieu of the object identifier generated for each object. In response to the receipt of a request to perform any of a variety of operations, including the retrieval of objects to transmit to another device or the performance of a job flow, the one or more federated devices may retrieve the indications of such aspects of storage from the object location identifier for each object that is to be accessed. The one or more federated devices may then use the retrieved indications in retrieving those objects and/or in determining whether to use the processing resources of the device(s) in which one or more of the objects are stored and/or the processing resources of other device(s) in performing a job flow.

[0173] By way of example, where a data set that is required as an input to a job flow is sufficiently large (e.g., exceeds a predetermined threshold size) that it has been divided into multiple blocks and stored in a distributed manner among multiple storage devices, it may be deemed desirable to employ the processing resources of the multiple storage devices among which that data set is distributed to perform the job flow so as to avoid incurring the overhead of transmitting such a large data set to the one or more federated devices so as to use the processing resources of the one or more federated devices to perform the job flow. Stated differently, it may be deemed desirable to essentially use the data set in situ within the storage devices in which it is already stored. This may be in spite of the one or more federated devices having superior processing resources such that the performance of one or more of the tasks of the job flow may be accomplished more quickly and/or efficiently using those processing resources, but where the overhead in transmitted the data set to the one or more federated devices would overwhelm the benefits of using those processing resources. In this way, the transmission of any portion of the data set among the storage and/or federated devices may be

entirely avoided by the job flow being performed within the multiple storage devices among which the blocks of the data set are locally stored, and at least partially in parallel among those multiple storage devices.

[0174] Also among the aspects of the storage of at least data objects for which indications may be stored may be such aspects as their origins. More precisely, for each data object, indications may be stored as to whether each data object was generated as an output of a performance of a job flow within the distributed processing system, was generated as an output of a performance of a job flow within an other processing device and/or system before being provided to the distributed processing system, and/or was provided to the distributed processing system without any indication of its origins. In some embodiments, such indications of data object origins may be useful when the functionality of one or more job flows is being analyzed as part of enforcing accountability for sources of errors that may be discovered in past performances of job flows. By way of example, it may be deemed useful to know whether a data object used as an input to a job flow was generated in a past performance of another job flow, or was possibly generated in an entirely different way by an outside source, in a situation in which the difference in characteristics of a data object generated in one of these ways versus the other may be significant in understanding an occurrence of a failure in a performance of a job flow. Alternatively or additionally, in some embodiments, such indications of origins may be useful during the automated generation of a new job flow that is to be capable of generating a specified output from a specified input. More specifically, indications that one or more data objects needed as input are not able to be traced to having been generated as the output(s) of earlier performance(s) of one or more job flows may be deemed useful in identifying error condition(s) that may arise during such automated generation of a new job flow.

[0175] However, and as will be familiar to those skilled in the art, as originally received by the one or more federated devices, the data set may be in a form in which its data items are organized therein in complex manner that does not entail the use of a single data structure throughout (e.g., not a single two-dimensional array throughout). Alternatively or additionally, the data set may incorporate metadata within a particular portion thereof that specifies the manner in which the data items are organized therein (e.g., as a header at the head of a data file that specifies the type of data structure and/or indexing scheme used), and the manner of organization of the data items may be sufficiently complex as to be prohibitively difficult to identify without reference to that metadata. If such a data set is then simply divided up into blocks and distributed among the multiple storage devices or multiple federated devices, it may be that different ones of the blocks are caused to include portions of different data structures from within the data set such that the manner in which the data items are organized within the data blocks differs among the data blocks such that the manner in which data is accessed within each data block may differ among the data blocks. Alternatively or additionally, where the data set incorporates metadata, it may be that just one of the blocks includes the metadata, and that one block may then be distributed to just one of the multiple storage devices or multiple federated devices, thereby depriving the others of the information needed to access and use the data items within the blocks that are distributed to them. To make the

data items within the other blocks accessible to the storage devices or federated devices within which they are stored, the metadata would have to be transmitted to the other ones of the multiple storage devices or multiple federated devices by the one storage device or federated device, respectively, that received the metadata within the block that was distributed to it.

[0176] To avoid such situations, prior to the storage of such a data set within a federated area, the one or more federated devices that receive the data set may analyze the form of the data set upon its receipt to determine whether or not the data items therein are already organized in a manner that is homogeneous throughout the data set such that it is already in a distributable form in which it is amenable to being divided into blocks in which data items would be organized in an identical manner. In some embodiments, the type of homogeneous organization of data items within the set may be additionally required to match one of what may be a set of preselected types of homogeneous organization that may each employ a particular bit-wise and/or byte-wise formatting (e.g., a tabular format with a particular byte alignment), and/or a particular use of particular delimiters (e.g., as text made up of comma-separated variables or CSV). If the data set does not include a distinct metadata data structure, if the data items within the data set are organized in a homogeneous manner, and/or if that manner of organization is of a type that is among such a preselected set of types (in embodiments in which such a requirement exists), then the one or more federated devices may proceed to cooperate thereamong and/or with multiple storage devices to divide and store the data thereamong as multiple blocks in a distributed manner.

[0177] However, if the data set does include a distinct metadata data structure, or if the data items within the data set are not organized therein in a homogeneous manner, or if that manner of organization is of a type that is not among such a preselected set of types (again, in embodiments in which such a requirement exists), then the one or more federated devices that received the data set may convert the data set from the form in which it was received, and into a distributable form where there is no distinct metadata data structure, where the data items are organized therein in a homogeneous manner throughout, and where that homogeneous manner of organization is one of such preselected types. In so doing, where the original form of the data set includes a distinct metadata data structure, the one or more federated devices may use that metadata as a guide in accessing the data items therein, while generating a corresponding distributable form of the data set in which the same data items are organized in a homogeneous manner that, again, will enable the data items to be more readily accessible after the distributable form of the data set has been divided into multiple blocks. Following such conversion, the one or more federated devices may provide the distributable form of the data set to a set of multiple storage devices for being divided into blocks that are then distributed among the multiple storage devices as part of effecting distributed storage of the data set.

[0178] Also following such conversion, the one or more federated devices may store an indication of various aspects of the storage of the data set for future use in accessing it. More specifically, the one or more federated devices may generate an object location identifier that includes indications of such aspects, including and not limited to, which

federated area it is stored within, which federated device(s) and/or storage device(s) it is stored within, its size, the fact that it is stored in a distributed manner, and/or the fact that it is stored in a distributable form.

[0179] Regardless of whether the data set was originally received already in a distributable form or was converted into a distributable form, with the distributable form of the data set now stored in a distributed manner, the homogeneous manner of storage of the data items within each of the blocks distributed to one of the multiple storage devices or federated devices enables an at least partially parallel performance of a job flow using each of the blocks as an input thereto in a manner that does not entail exchanges of information among the multiple storage devices. Stated differently, the data items within each block is able to be accessed and used locally within the device in which it is stored as an independent input to one of the parallel independent performances of a job flow within that device.

[0180] However, while such a large data set may be put through such conversion and then stored in such a distributed manner among the multiple storage devices such that there is a portion of the data set that is locally accessible to each of multiple storage devices or multiple federated devices, the other objects needed to perform a particular job flow may not be stored in a way in which each of those multiple devices has such local access to them. More precisely, the job flow definition and the task routines also needed to perform the job flow may each be stored as an undivided object within just a single one of those devices and/or within just a single one of still other devices. It should be noted that such objects as the job flow definition and each of the task routines may be expected to be of significantly smaller size than the data set (e.g., smaller than the predetermined threshold size) such that division into blocks for storage is deemed unnecessary. As a result, it may be that none or just one of those devices has local access to all of the objects needed to perform the particular job flow.

[0181] To address this issue, the one or more federated devices that may receive a request to perform the particular job flow may retrieve each of the other objects needed to perform the particular job flow from wherever they may be stored, and may then distribute copies of those other objects to each one of the multiple devices in which a block of the data set is stored. In so doing, the one or more federated devices may assemble those other objects into a container, along with additional executable instructions that enable the processor(s) of each of those devices in which one or more blocks of the data set are stored to perform the job flow using the block(s) of the data set that are stored therein, including the execution of the task routines.

[0182] The performance of the job flow with the data set as an input may be expected to result in the generation of another data object as an output, i.e., a result report. However, since the performance of the job flow using the processing resources of those multiple devices is as multiple at least partially parallel performances, the result report is necessarily generated as multiple separate blocks that each correspond to one of the blocks of the data set. In some embodiments, it may be a normal procedure to store the result report in a federated area to preserve it for future analyses as part of the earlier described policy of maintaining accountability for the results of performing job flows. However, in other embodiments, there may be provided an ability for the request to perform the particular job flow to

include the ability to specify which data objects are to be so preserved, and which are not. Thus, in such embodiments, where the result report has not been specified as a data object to be preserved, the one or more federated devices that received the request to perform the particular job flow may delete the blocks of the result report upon completion of the performance of the particular job flow and/or upon determining that the result report is not used as an input to any other task within the job flow.

[0183] However, where the result report is meant to be preserved in a federated area (either by default as part of normal procedures or as a result of being specified as a data object to be preserved), the one or more federated devices may retrieve and assemble the blocks of the result report into a single undivided form of the result report, assign it a result report identifier, and then cooperate with one or more storage devices or federated devices to store it within a federated area. Where the result report, as assembled, is of a size that falls below the predetermined threshold size, the result report may be deemed too small to necessitate being stored in a distributed manner as the data set was, and therefore, may be stored as a undivided data object within a single storage device or federated device. However, if the assembled result report is of a size greater than the predetermined threshold size, then the result report may then be divided back into blocks and stored among multiple storage devices or multiple federated devices in a distributed manner, just as the data set was. Additionally, the one or more federated devices may store indications of various aspects of the storage of the results report, including and not limited to, which federated area it is stored within, which federated device(s) and/or storage device(s) it is stored within, its size, whether it is stored in an undivided manner or in a distributed manner, and/or whether it is stored in a distributable form (if it is stored in a distributed manner).

[0184] In some embodiments, the one or more federated devices may support the execution of a set of task routines written in differing programming languages as part of performing a job flow. As will be explained in greater detail, this may arise where it is deemed desirable to support collaborations among developers who are familiar with differing programming languages, but who are each contributing different objects, including task routines, the development of a job flow. To enable this, the one or more federated devices may employ a multitude of runtime interpreters and/or compilers for a pre-selected set of multiple programming languages to execute such a set of task routines during the performance of a job flow.

[0185] As will also be explained in greater detail, during the performance of a job flow, there may instances of a task routine generating a data set as an output that is to then be used as an input to one or more other task routines (e.g., a mid-flow data set). That data may be persisted by being stored in a federated area as a new data object that is assigned a unique identifier just as a data object received from a source device would be. As previously discussed, this may be done as part of enabling accountability concerning how an analysis is performed by preserving data sets that are generated as an output by one task routine for use as an input to another. However, where two or more task routines that exchange a data set thereamong are written in different programming languages, the data set so exchanged may be subjected to a conversion process to in some way change its form (e.g., serialization or de-serialization) to accommodate

differences in data types and/or formats that are supported by the different programming languages (e.g., to resolve differences in the manner in which arrays are organized and/or accessed). Where such a conversion is performed, it may be that just one of the forms of the data set may be persisted to a federated area while the other form may be temporarily stored in a shared memory space that may be instantiated just for the duration of the performance of the job flow and that may be uninstantiated at the end of that performance.

[0186] In some embodiments, a request for a performance of a job flow may specify that the input/output behavior of the task routines used during the performance be verified. More specifically, it may be requested that the input/output behavior of the task routines that are executed during the performance of a job flow be monitored, and that the observed input/output behavior of each of those task routines with regard to accessing data objects and/or engaging in any other exchange of inputs and/or outputs be compared to the input and/or output interfaces that may be implemented by their executable instructions, that may be specified in any comments therein, and/or that may be specified in the job flow definition of the job flow that is performed. Each task routine that exhibits input/output behavior that remains compliant with such specifications during its execution may be in some way marked and/or recorded as having verified input/output behavior. Each task routine that exhibits input/output behavior that goes beyond such specifications may be in some way marked and/or recorded as having aberrant input/output behavior.

[0187] To perform such monitoring of the input/output behavior of task routines, each task routine that is executed during the performance of a particular job flow may be so executed within a container environment instantiated within available storage space by a processor of one of the federated devices. More specifically, such a container environment may be defined to limit accesses that may be made to other storage spaces outside the container environment and/or to input and/or output devices of the federated device. In effect, such a container environment may be given a set of access rules by which input/output behaviors that comply with input/output behaviors that are expected of particular task routine are allowed to proceed, while other input/output behaviors that go beyond the expected input/output behaviors may be blocked while the storage locations that were meant to be accessed by those aberrant input/output behaviors are recorded to enable accountability for such misbehavior by a task routine, and/or to serve as information that may be required by a programmer to correct a portion of the executable instructions within such a task routine to correct its input/output behavior.

[0188] By way of example, and still more specifically, such comments within a task routine and/or such specifications within a job flow definition may specify various aspects of its inputs and/or outputs, such data type, indexing scheme, etc. of data object(s), but may refrain from specifying any particular data object as part of an approach to allowing particular data object(s) to be specified by a job flow definition, or in any of a variety of other ways, during the performance of the job flow in which the task routine may be executed and/or that is defined by the job flow definition. Instead, a placeholder designator (e.g., a variable) may be specified that is to be given a value indicative of a specific data object during the performance of a job flow. Alternatively, where one or more particular data objects are

specified, such specification of one or more particular data objects may be done as a default to address a situation in which one or more particular data objects are not specified by a job flow definition and/or in another way during performance of a job flow in which the task routine may be executed. Regardless of whether particular data objects are specified, following the retrieval and interpretation of such input/output specifications, a container environment may be instantiated that is configured to enable the task routine to be executed therein and that allows the task routine to engage in input/output behavior that conforms to those input/output specifications, but which does not allow the task routine to engage in aberrant input/output behavior that goes beyond what it is expected based on those input/output specifications. Depending on the input/output behavior that is observed as the task routine is so executed, the task routine may be marked as being verified as engaging in correct input/output behavior or may be marked as being observed engaging in aberrant input/output behavior.

[0189] In some embodiments, the marking of the results of such monitoring of input/output behavior of each task routine may be incorporated into task routine database(s) that may be used to organize the storage of task routines within one or more federated areas as part of enabling more efficient selection and retrieval of task routines for provision to a requesting device and/or for execution. In some of such embodiments, such marking of task routines may also play a role in which task routines are selected to be provided to a requesting device and/or to be executed as part of performing a job flow. As an alternative to such marking of such input/output behavior of a task routine being maintained by a task routine database, a separate and distinct data structure may be maintained within the federated area in which the task routine is stored as a repository of indications of such input/output behavior by the task routine and/or by multiple task routines (e.g., a data file of such indications). Alternatively or additionally, and regardless of the exact manner in which such indications of such input/output behavior of a task routine may be stored, in some embodiments, such stored indications of either correct or aberrant input/output behavior of a task routine may be reflected in instance logs from performances of job flows in which the task routine was executed and/or in a visual representation of the task routine in a DAG.

[0190] Some requests to perform a job flow may include a request to perform a specified job flow of an analysis with one or more specified data objects. Other requests may be to repeat a past performance of a job flow that begat a specified result report, or that entailed the use of a specific combination of a job flow and one or more data sets as inputs. Still other requests may specify the performance of a set of tasks using a set of data objects as inputs, but may not specify a job flow. Through the generation of identifiers for each of the various objects associated with each performance of a job flow, through the use of those identifiers to refer to such objects in instance logs, and through the use of those identifiers by the one or more federated devices in accessing such objects, requests for performances of analyses are able to more efficiently identify particular performances, their associated objects and/or related objects.

[0191] Regardless of the exact type of request received, each request may have formatting, syntax and/or other characteristics selected to cause the request to conform to one or more industry specifications for communications

between devices. More specifically, the request may be generated by the requesting device to have characteristics conforming to one or more of the versions of the Message-Passing Interface (MPI) specification promulgated by the MPI Forum, which is a cooperative venture by numerous governmental, corporate and academic entities from around the world. Further, the manner in which the federated devices and/or storage devices communicate to effect the requested performance of the set of specified tasks may conform to one or more versions of the MPI specification, and/or the manner in which response(s) to the request are transmitted back to the requesting device may do so.

[0192] In embodiments in which a request is received to perform a specified job flow of an analysis with one or more specified data objects as inputs, the one or more federated devices may use the identifiers of those objects that are provided in the request to analyze the instance logs stored in one or more federated areas to determine whether there was a past performance of the same job flow with the same one or more data objects as inputs. If there was such a past performance, then the result report generated as the output of that past performance may already be stored in a federated area. As long as none of the task routines executed in the earlier performance have been updated since the earlier performance, then a repeat performance of the same job flow with the same one or more data objects serving as inputs may not be necessary. Thus, if any instance logs are found for such an earlier performance, the one or more federated devices may analyze the instance log associated with the most recent earlier performance (if there has been more than one past performance) to obtain the identifiers uniquely assigned to each of the task routines that were executed in that earlier performance. The one or more federated devices may then analyze each of the uniquely identified task routines to determine whether each of them continues to be the most current version stored in the federated area for use in performing its corresponding task. If so, then a repeated performance of the job flow with the one or more data objects identified in the request is not necessary, and the one or more federated devices may retrieve the result report generated by the past performance from a federated area and transmit that result report to the device from which the request was received.

[0193] However, if no instance logs are found for any past performance of the specified job flow with the specified one or more data objects that entailed the execution of the most current version of each of the task routines, then the one or more federated devices may perform the specified job flow with the specified data objects using the most current version of task routine for each task specified with a flow task identifier in the job flow definition. Indeed, and as will be explained in greater detail, it may be that the most current version of each task routine may be selected and used in performing a task by default, unless a particular earlier version is actually specified to be used. The one or more federated devices may then assign a unique identifier to and store the new result report generated during such a performance in a federated area, as well as transmit the new result report to the device from which the request was received. The one or more federated devices may also generate and store in a federated area a corresponding new instance log that specifies details of the performance, including the identifier of the job flow definition, the identifiers of all of the most current versions of task routines that were

executed, the identifiers of the one or more data objects used as inputs and/or generated as outputs, and the identifier of the new result report that was generated.

[0194] In embodiments in which a request is received to repeat a past performance of a job flow of an analysis that began a result report identified in the request by its uniquely assigned identifier, the one or more federated devices may analyze the instance logs stored in one or more federated areas to retrieve the instance log associated with the past performance that resulted in the generation of the identified result report. The one or more federated devices may then analyze the retrieved instance log to obtain the identifiers for the job flow definition that defines the job flow, the identifiers for each of the task routines executed in the past performance, and the identifiers of any data objects used as inputs in the past performance. Upon retrieving the identified job flow definition, each of the identified task routines, and any identified data objects, the one or more federated devices may then execute the retrieved task routines, using the retrieved data objects, and in the manner defined by the retrieved job flow definition to repeat the past performance of the job flow with those objects to generate a new result report. Since the request was to repeat an earlier performance of the job flow with the very same objects, the new result report should be identical to the earlier result report generated in the past performance such that the new result report should be a regeneration of the earlier result report. The one or more federated devices may then assign an identifier to and store the new result report in a federated area, as well as transmit the new result report to the device from which the request was received. The one or more federated devices may also generate and store, in a federated area, a corresponding new instance log that specifies details of the new performance of the job flow, including the identifier of the job flow definition, the identifiers of all of the task routines that were executed, the identifiers of the one or more data objects used as inputs and/or generated as outputs, and the identifier of the new result report.

[0195] In embodiments in which one or more federated devices may receive a request to perform a set of tasks specified in the request using one or more data objects also specified in the request as input(s) thereto, and without specifying a job flow definition that would define an order in which the set of tasks is to be performed, the one or more federated devices may analyze the specification of data objects as input(s) and/or output(s) of each task, and/or may analyze the definition of input and/or output interface(s) of each task, to identify dependencies thereamong, and to thereby identify opportunities for at least partially parallel performances thereamong. Where the request includes or is accompanied by one or more of the specified data objects, the one or more federated devices may store each such data object in a federated area prior to commencing performance of the one(s) of the specified tasks that require such data as input.

[0196] In various embodiments, a request may be received to perform a specified set of tasks using one or more data objects as inputs where the request makes no reference, either directly or indirectly, to any job flow definition that may already be stored in a federated area. Indeed, it may be that there is no pre-existing job flow definition for performing the specified set of tasks. The request may additionally specify which data object(s) that are generated as outputs during the performance of the set of tasks are to be stored

within a federated area and/or are to be transmitted back to the device from which the request is received. The specification of each task in the request may include the specification of the one or more data objects that are to be used as its inputs, and/or may include the specification of the one or more data objects that are to be generated as outputs. Alternatively or additionally, the specification of each task in the request may define the input and/or output interfaces thereof, or there may be reliance on the definition of the input and/or output interfaces provided by the executable instructions and/or comments of the one or more task routines that perform each of the specified tasks when executed. In effect, it may be that the request, itself, includes at least a subset of the information that would normally be specified in a job flow definition.

[0197] In some of such requests, one or more objects required for the performance of the specified set of tasks may be provided along with the request. By way of example, one or more of the data objects to be used as an input may be directly incorporated into the request and/or may otherwise accompany the request. In response, the one or more federated devices may initially store such data object(s) in a federated area before commencing the requested performance of the set of tasks.

[0198] The one or more federated devices may analyze the specification in the request of each task, along with any specification in the request of data objects that are the input(s) and/or output(s) of each specified task, and/or along with any definition in the request of input and/or output interface(s) for each specified task, to identify dependencies among the specified tasks. From at least these identified dependencies, a job flow definition for the requested performance of the set of tasks may be derived. In so doing, the one or more federated devices may also identify opportunities for parallelism in which different ones of the specified tasks are able to be performed at least partially in parallel as a result of a lack of dependencies thereamong.

[0199] Alternatively or additionally, where a data object specified as an input is stored in a distributed manner across multiple federated devices or multiple storage devices, the one or more federated devices that received the request may employ such distributed storage as an opportunity for at least partially parallel performances of multiple instances of a task that requires that data object as an input by selecting the multiple federated devices or multiple storage devices in which that data object is stored to be used in performing that task. In this way, such a distributed object may be used in situ where it is already stored, thereby obviating the need to exchange portions of it among devices. To enable such partially parallel performances of that task, each of the selected federated devices or storage devices may be provided with a container that includes a copy of a task routine that is to be executed to cause the performance of the task within each of the selected devices, any other executable routines that may be needed to support the execution of that task routine, and/or any other data objects also required as an input to each of the at least partially parallel performances of that task.

[0200] Each such at least partially parallel performance of that task may generate a separate block of a data object as an output. As a result, such a data object is generated in a distributed form. The one or more federated devices may retrieve and perform a reduction operation on those blocks of the generated data object if the request includes an

indication that the generated data object is to be stored in a federated area and/or is to be transmitted back to the requesting device from which the request was received. Otherwise, each of such blocks of the generated data object may be caused to simply remain stored within the federated device or the storage device within which it was generated, and may serve as an input to one of multiple at least partially parallel performances of another of the specified tasks.

[0201] In some embodiments, the one or more federated devices that received the request may initially attempt to determine whether the set of specified tasks has already been previously performed with the specified data object(s) as input. An attempt may be made to match the identifiers of the tasks specified in the request to an existing job flow definition in which the same set of tasks are performed. The identifier of that matching job flow definition may then be used along with the identifiers of each of the data objects specified in the request to attempt to identify an instance log that documents a past performance of the job flow defined by the matching job flow definition with the same data objects specified as inputs thereto. In response to having identified such a matching instance log, the identifier(s) provided therein for each of the data objects generated as output may be used to retrieve each of those output data objects, and then those output data objects may be transmitted to the requesting device in lieu of performing the set of tasks specified in the request.

[0202] The request may have formatting, syntax and/or other characteristics selected to cause the request to conform to one or more industry specifications for communications between devices. More specifically, the request may be generated by the requesting device to have characteristics conforming to one or more of the versions of the Message-Passing Interface (MPI) specification promulgated by the MPI Forum, which is a cooperative venture by numerous governmental, corporate and academic entities from around the world. Still more specifically, the request may be generated to conform to the specification for OpenMPI, a variant of MPI promulgated by Software in the Public Interest (SPI) of New York, N.Y. in the USA.

[0203] In such embodiments, the manner in which each task, its inputs and/or its outputs are specified in the request may conform to a format for an application programming interface (API) associated with one or more of the versions of the MPI specification. Alternatively or additionally, the request may embed one or more of the specified data objects required as input the performance of the set of specified tasks as streaming data in accordance with one or more of the versions of the MPI specification. Further, the manner in which the federated devices and/or storage devices communicate to effect the requested performance of the set of specified tasks may conform to one or more versions of the MPI specification, and/or the manner in which response(s) to the request are transmitted back to the requesting device may do so.

[0204] In support enabling the objects stored within one or more federated areas to be used in performances of job flows, and/or in support of enabling accountability in analyzing aspects of a past performance of a job flow, a set of rules may be enforced by the one or more federated devices that limit what actions may be taken in connection with each object. Such enforced limitations in access to each object may be in addition to the aforementioned restrictions on accesses to federated area(s) that may be imposed on enti-

ties, persons and/or particular devices. Such rules may restrict what objects are permitted to be stored and/or when, and/or may restrict what objects are able to be altered and/or removed as part of preventing instances of there being "orphan" objects that are not accompanied in storage by other objects that may be needed to support a performance or a repetition of a performance of a job flow. Alternatively or additionally, such rules may restrict what objects are permitted to be stored and/or when as part of preventing instances of incompatibility between objects that are to be used together in a performance of a job flow.

[0205] By way of example, whether a job flow definition will be permitted to be stored within a federated area may be made contingent on whether, for each task that is specified in the job flow definition, there is at least one task routine that is already stored in the federated area and/or is about to be stored in the federated area along with the job flow definition. Such a rule that imposes such a condition on the storage of a job flow definition may be deemed desirable to prevent a situation in which there is a job flow definition stored in a federated area that defines a job flow that cannot be performed as a result of there being a task specified therein that cannot be performed due to the lack of storage in a federated area of any task routine that can be executed to perform that task. Similarly, and by way of another example, whether an instance log will be permitted to be stored within a federated area may be made contingent on whether each object identified in the instance log as being associated with a past performance of the job flow documented by the instance log is already stored in the federated area and/or is about to be stored in the federated area along with the instance log. Such a rule that imposes such a condition on the storage of an instance log may be deemed desirable to prevent a situation in which there is an instance log stored in a federated area that documents a past performance of a job flow that cannot be repeated due to the lack of storage in a federated area of an object specified in the instance log as being associated with that past performance.

[0206] By way of another example, whether a job flow definition will be permitted to be stored within a federated area may alternatively or additionally be made contingent on whether, the input and/or output interfaces specified for each task in the job flow definition are a sufficient match to the input and/or output definitions implemented by the already stored task routines that perform each of those tasks. Such a rule that imposes such a condition on the storage of a job flow definition may be deemed desirable to prevent incompatibilities between the specifications of interfaces in a job flow definition and the implementations of interfaces in the corresponding task routines. Similarly, and by way of still another example, whether a new version of a task routine that performs a particular task when executed will be permitted to be stored within a federated area may be made contingent on whether, the input and/or output definitions implemented within the new task routine are a sufficient match to the input and/or output definitions implemented by the one or more already stored task routines that also perform the same task. Such a rule that imposes such a condition on the storage of a new task routine may be deemed desirable to prevent incompatibilities between versions of task routines that perform the same task.

[0207] By way of still another example, whether a data object (e.g., flow input data set, a mid-flow data set, or result report) or a task routine is permitted to be deleted from a

federated area may be made contingent on whether its removal would prevent a job flow that is defined in a job flow definition from being performed and/or whether its removal would prevent a past performance of a job flow that is documented by an instance log from being repeated. Such a rule that imposes such a condition may be deemed desirable to prevent a situation in which there is a job flow definition stored in a federated area that defines a job flow that cannot be performed due to the lack of storage in a federated area of any task routine that can be executed to perform one of the tasks specified in the job flow definition. Also, such a rule that imposes such a condition may be deemed desirable to prevent a situation in which there is an instance log stored in a federated area that documents a past performance of a job flow that cannot be repeated due to the lack of storage in a federated area of a data object or task routine specified in the instance log as being associated with that past performance. Similarly, and by way of yet another example, whether a job flow definition is permitted to be deleted from a federated area may be made contingent on whether its removal would prevent a past performance of the corresponding job flow that is documented by an instance log from being repeated. Such a rule that imposes such a condition may be deemed desirable to prevent a situation in which there is an instance log stored in a federated area that documents a past performance of a job flow that cannot be repeated due to the lack of storage in a federated area of the job flow definition for that job flow.

[0208] With such restrictions against the removal of objects from a federated area, an alternative that may be allowed by the set of rules may be the storing of newer versions of objects. By way of example, where an earlier version of a task routine or a job flow definition is determined to have flaws and/or to be in need of replacement for some other reason, the set of rules may allow a newer (and presumably improved) version of such a task routine or job flow definition to be stored so that it can be used instead of the earlier version. As previously discussed, while each version of each task routine may be assigned a unique identifier generated from the taking of a hash of thereof such that each version of each task routine is individually identifiable and selectable, each task routine is also assigned a flow task identifier that specifies the task that it performs when executed. As previously discussed, task routines may subsequently be searched for and selected based on their flow task identifiers, and use of the most current version of task routine to perform each task specified in a job flow by a flow task identifier may be the default rule. As a result, the storage of a new version of a task routine that performs a task identified by a particular flow task identifier may be relied upon to cause the use of any earlier versions of task routine that also perform that same task identified by that same flow task identifier to cease, except in situations where the use of a particular earlier version of task routine to perform a particular task is actually specified.

[0209] Through such pooling of older and newer versions of objects, through the provision of unique identifiers for each object, and through the enforcement of such a regime of rules restricting accesses that may be made to one or more federated areas, objects such as data sets, task routines and job flow definitions are made readily available for reuse under conditions in which their ongoing integrity against inadvertent and/or deliberate alteration is assured. The provision of a flow task identifier for each task may enable

updated versions of task routines to be independently created and stored within one or more federated areas in a manner that associates those updated versions with earlier versions without concern of accidental overwriting of earlier versions.

[0210] As a result of such pooling of data sets and task routines, new analyses may be more speedily created through reuse thereof by generating new job flows that identify already stored data sets and/or task routines. Additionally, where a task routine is subsequently updated, advantage may be automatically taken of that updated version in subsequent performances of each job flow that previously used the earlier version of that task routine. And yet, the earlier version of that task routine remains available to enable a comparative analysis of the results generated by the different versions if discrepancies therebetween are subsequently discovered. Also, as a result of such pooling of data sets, task routines and job flows, along with instance logs and result reports, repeated performances of a particular job flow with a particular data set can be avoided. Through use of identifiers uniquely associated with each object and recorded within each instance log, situations in which a requested performance of a particular job flow with a particular data set that has been previously performed can be more efficiently identified, and the result report generated by that previous performance can be more efficiently retrieved and made available in lieu of consuming time and processing resources to repeat that previous performance. And yet, if a question should arise as to the validity of the results of that previous performance, the data set(s), task routines and job flow definition on which that previous performance was based remain readily accessible for additional analysis to resolve that question.

[0211] Also, where there is no previous performance of a particular job flow with a particular data set such that there is no previously generated result report and/or instance log therefor, the processing resources of the grid of federated devices may be utilized to perform the particular job flow with the particular data set. The ready availability of the particular data set to the grid of federated devices enables such a performance without the consumption of time and network bandwidth resources that would be required to transmit the particular data set and other objects to the requesting device to enable a performance by the requesting device. Instead, the transmissions to the requesting device may be limited to the result report generated by the performance. Also, advantage may be taken of the grid of federated devices to cause the performance of one or more of the tasks of the job flow as multiple instances thereof in a distributed manner (e.g., at least partially in parallel) among multiple federated devices and/or among multiple threads of execution support by processor(s) within each such federated device.

[0212] As a result of the requirement that the data set(s), task routines and the job flow associated with each instance log be preserved, accountability for the validity of results of past performances of job flows with particular data sets is maintained. The sources of incorrect results, whether from invalid data, or from errors made in the creation of a task routine or a job flow, may be traced and identified. By way of example, an earlier performance of a particular job flow with a particular data set using earlier versions of task routines can be compared to a later performance of the same job flow with the same data set, but using newer versions of

the same task routines, as part of an analysis to identify a possible error in a task routine. As a result, mistakes can be corrected and/or instances of malfeasance can be identified and addressed.

[0213] The one or more federated devices may maintain one or more sets of federated areas that may be related to each other through a set of relationships that serve to define a hierarchy of federated areas in which the different federated areas may be differentiated by the degree of restriction of access thereto that may be enforced by the one or more federated devices. In some embodiments, a linear hierarchy may be defined in which there is a base federated area with the least restricted degree of access, a private federated area with the most restricted degree of access, and/or one or more intervening federated areas with intermediate degrees of access restriction interposed between the base and private federated areas. Such a hierarchy of federated areas may be created to address any of a variety of situations in support of any of a variety of activities, including those in which different objects stored thereamong require different degrees of access restriction. By way of example, while a new data set or a new task routine is being developed, it may be deemed desirable to maintain it within the private federated area or intervening federated area to which access is granted to a relatively small number of users (e.g., persons and/or other entities that may each be associated with one or more source devices and/or reviewing devices) that are directly involved in the development effort. It may be deemed undesirable to have such a new data set or task routine made accessible to others beyond the users involved in such development before such development is completed, such that various forms of testing and/or quality assurance have been performed. Upon completion of such a new data set or task routine, it may then be deemed desirable to transfer it, or a copy thereof, to the base federated area or other intervening federated area to which access is granted to a larger number of users. Such a larger number of users may be the intended users of such a new data set or task routine.

[0214] It may be that multiple ones of such linear hierarchical sets of federated areas may be combined to form a tree of federated areas with a single base federated area with the least restricted degree of access at the root of the tree, and multiple private federated areas as the leaves of the tree that each have more restricted degrees of access. Such a tree may additionally include one or more intervening federated areas with various intermediate degrees of access restriction to define at least some of the branching of hierarchies of federated areas within the tree. Such a tree of federated areas may be created to address any of a variety of situations in support of any of a variety of larger and/or more complex activities, including those in which different users that each require access to different objects at different times are engaged in some form of collaboration. By way of example, multiple users may be involved in the development of a new task routine, and each such user may have a different role to play in such a development effort. While the new task routine is still being architected and/or generated, it may be deemed desirable to maintain it within a first private federated area or intervening federated area to which access is granted to a relatively small number of users that are directly involved in that effort. Upon completion of such an architecting and/or generation process, the new task routine, or a copy thereof, may be transferred to a second private federated area or intervening federated area to which access is

granted to a different relatively small number of users that may be involved in performing tests and/or other quality analysis procedures on the new task routine to evaluate its fitness for release for use. Upon completion of such testing and/or quality analysis, the new task routine, or a copy thereof, may be transferred to a third private federated area or intervening federated area to which access is granted to yet another relatively small number of users that may be involved in pre-release experimental use of the new task routine to further verify its functionality in actual use case scenarios. Upon completion of such experimental use, the new task routine, or a copy thereof, may be transferred to a base federated area or other intervening federated area to which access is granted to a larger number of users that may be the intended users of the new task routine.

[0215] In embodiments in which multiple federated areas form a tree of federated areas, each user may be automatically granted their own private federated area as part of being granted access to at least a portion of the tree. Such an automated provision of a private federated area may improve the ease of use, for each such user, of at least the base federated area by providing a private storage area in which a private set of job flow definitions, task routines, data sets and/or other objects may be maintained to assist that user in the development and/or analysis of other objects that may be stored in at least the base federated area. By way of example, a developer of task routines may maintain a private set of job flow definitions, task routines and/or data sets in their private federated area for use as tools in developing, characterizing and/or testing the task routines that they develop. The one or more federated devices may be caused, by such a developer, to use such job flow definitions, task routines and/or data sets to perform compilations, characterizing and/or testing of such new task routines within the private federated area as part of the development process therefor. Some of such private job flow definitions, task routines and/or data sets may include and/or may be important pieces of intellectual property that such a developer desires to keep to themselves for their own exclusive use (e.g., treated as trade secrets and/or other forms of confidential information).

[0216] A base federated area within a linear hierarchy or hierarchical tree of federated areas may be the one federated area therein with the least restrictive degree of access such that a grant of access to the base federated area constitutes the lowest available level of access that can be granted to any user. Stated differently, the base federated area may serve as the most “open” or most “public” space within a linear hierarchy or hierarchical tree of federated spaces. Thus, the base federated area may serve as the storage space at which may be stored job flow definitions, versions of task routines, data sets, result reports and/or instance logs that are meant to be available to all users that have been granted any degree of access to the set of federated areas of which the base federated area is a part. The one or more federated devices may be caused, by a user that has been granted access to at least the base federated area, to perform a job flow within the base federated area using a job flow definition, task routines and/or data sets stored within the base federated area.

[0217] In a linear hierarchical set of federated areas that includes a base federated area and just a single private federated area, one or more intervening federated areas may be interposed therebetween to support the provision of

different levels of access to other users that don't have access to the private federated area, but are meant to be given access to more than what is stored in the base federated area. Such a provision of differing levels of access would entail providing different users with access to either just the base federated area, or to one or more intervening federated areas. Of course, this presumes that each user having any degree of access to the set of federated areas is not automatically provided with their own private federated area, as the resulting set of federated areas would then define a tree that includes multiple private federated areas, and not a linear hierarchy that includes just a single private federated area.

[0218] In a hierarchical tree of federated areas that includes a base federated area at the root and multiple private federated areas at the leaves of the tree, one or more intervening federated areas may be interposed between one or more of the private federated areas and the base federated areas in a manner that defines at least part of one or more branches of the tree. Through such branching, different private federated areas and/or different sets of private federated areas may be linked to the base federated area through different intervening federated areas and/or different sets of intervening federated areas. In this way, users associated with some private federated areas within one branch may be provided with access to one or more intervening federated areas within that branch that allow sharing of objects thereamong, while also excluding other users associated with other private federated areas that may be within one or more other branches. Stated differently, branching may be used to create separate sets of private federated areas where each such set of private federated areas is associated with a group of users that have agreed to more closely share objects thereamong, while all users within all of such groups are able to share objects through the base federated area, if they so choose.

[0219] In embodiments in which there are multiple federated areas that form either a single linear hierarchy or a hierarchical tree, each of the federated areas may be assigned one or more identifiers. It may be that each federated area is assigned a human-readable identifier, such as names that are descriptive of ownership (e.g., "Frank's"), names that are descriptive of degree of access (e.g., "public" vs. "private"), names of file system directories and/or sub-directories at which each of the federated areas may be located, and/or names of network identifiers by which each federated area may be accessible on a network. However, it may be that each federated area is also assigned a randomly generated identifier with a large enough bit width that it is highly likely that each such identifier is unique across all federated areas anywhere in the world (e.g., a "global" identifier or "GUID"). Such a unique identifier for each federated area may provide a mechanism to resolve identification conflicts where perhaps two or more federated areas may have been given identical human-readable identifiers.

[0220] In one example of assignment and use of identifiers, a set of federated areas that form either a single linear hierarchy or hierarchical tree may be assigned identifiers that make the linear hierarchy or hierarchical tree navigable through the use of typical web browsing software. More specifically, one or more federated devices may generate the portal to enable access, by a remote device, to the set of federated areas from across a network using web access protocols, file transfer protocols and/or other protocols in which each of multiple federated areas is provided with a

human-readable identifier in the form of a uniform resource locator (URL). In so doing, the URLs assigned thereto may be structured to reflect the hierarchy that has been defined among the federated areas therein. Thus, for a tree of federated areas, the base federated area at the root of the tree may be assigned the shortest and simplest URL, and such a URL given to the base federated area may be indicative of a name given to that entire tree of federated areas. In contrast, the URL of each federated area at a leaf of the tree may include a combination (e.g., a concatenation) of at least a portion of the URL given to the base federated area, and at least a portion of the URL given to any intervening federated area in the path between the federated area at the leaf and the base federated area.

[0221] In embodiments of either a linear hierarchy of federated areas or a hierarchical tree of federated areas, one or more relationships that affect the manner in which objects may be accessed and/or used may be put in place between each private federated area and the base federated area, as well as through any intervening federated areas therebetween. Among such relationships may be an inheritance relationship in which, from the perspective of a private federated area, objects stored within the base federated area, or within any intervening federated area therebetween, may be treated as if they are also stored directly within the private federated area for purposes of being available for use in performing a job flow within the private federated area. As will be explained in greater detail, the provision of such an inheritance relationship may aid in enabling and/or encouraging the reuse of objects by multiple users by eliminating the need to distribute multiple copies of an object among multiple private federated areas in which that object may be needed for performances of job flows within each of those private federated areas. Instead, a single copy of such an object may be stored within the base federated area and will be treated as being just as readily available for use in performances of job flows within each of such private federated areas.

[0222] Also among such relationships may be a priority relationship in which, from the perspective of a private federated area, the use of a version of an object stored within the private federated area may be given priority over the use of another version of the same object stored within the base federated area, or within any intervening federated area therebetween. More specifically, where a job flow is to be performed within a private federated area, and there is one version of a task routine to perform a task of the job flow stored within the private federated area and another version of the task routine to perform the same task stored within the base federated area, use of the version of the task routine stored within the private federated area may be given priority over use of the other version stored within the base federated area. Further, such priority may be given to using the version stored within the private federated area regardless of whether the other version stored in the base federated area is a newer version. Stated differently, as part of performing the job flow within the private federated area, the one or more federated devices may first search within the private federated area for any needed task routines to perform each of the tasks specified in the job flow, and upon finding a task routine to perform a task within the private federated area, no search may be performed of any other federated area to find a task routine to perform that same task. It may be deemed desirable to implement such a

priority relationship as a mechanism to allow a user associated with the private federated area to choose to override the automatic use of a version of a task routine within the base federated area (or an intervening federated area therebetween) due to an inheritance relationship by storing the version of the task routine that they prefer to use within the private federated area.

[0223] Also among such relationships may be a dependency relationship in which, from the perspective of a private federated area, some objects stored within the private federated area may have dependencies on objects stored within the base federated area, or within an intervening federated area therebetween. More specifically, as earlier discussed, the one or more federated devices may impose a rule that the task routines upon which a job flow depends may not be deleted such that the one or more federated devices may deny a request received from a remote device to delete a task routine that performs a task identified by a flow task identifier that is referred to by at least one job flow definition stored. Thus, where the private federated area stores a job flow definition that includes a flow task identifier specifying a particular task to be done, and the base federated area stores a task routine that performs that particular task, the job flow of the job flow definition may have a dependency on that task routine continuing to be available for use in performing the task through an inheritance relationship between the private federated area and the base federated area. In such a situation, the one or more federated devices may deny a request that may be received from a remote device to delete that task routine from the base federated area, at least as long as the job flow definition continues to be stored within the private federated area. However, if that job flow definition is deleted from the private federated area, and if there is no other job flow definition that refers to the same task flow identifier, then the one or more federated devices may permit the deletion of that task routine from the base federated area.

[0224] In embodiments in which there is a hierarchical tree of federated areas that includes at least two branches, a relationship may be put in place between two private and/or intervening federated areas that are each within a different one of two branches by which one or more objects may be automatically transferred therebetween by the one or more federated devices in response to one or more conditions being met. As previously discussed, the formation of branches within a tree may be indicative of the separation of groups of users where there may be sharing of objects among users within each such group, such as through the use of one or more intervening federated areas within a branch of the tree, but not sharing of objects between such groups. However, there may be occasions in which there is a need to enable a relatively limited degree of sharing of objects between federated areas within different branches. Such an occasion may be an instance of multiple groups of users choosing to collaborate on the development of one or more particular objects such that those particular one or more objects are to be shared among the multiple groups where, otherwise, objects would not normally be shared therebetween. On such an occasion, the one or more federated devices may be requested to instantiate a transfer area through which those particular one or more objects may be automatically transferred therebetween upon one or more specified conditions being met. In some embodiments, the transfer area may be formed as an overlap between two

federated areas of two different branches of a hierarchical tree. In other embodiments, the transfer area may be formed within the base federated area to which users associated with federated areas within different branches may all have access.

[0225] In some embodiments, the determination of whether the condition(s) for a transfer have been met and/or the performance of the transfer of one or more particular objects may be performed using one or more transfer routines to perform transfer-related tasks called for within a transfer flow definition. In such embodiments, a transfer routine may be stored within each of the two federated areas between which the transfer is to occur. Within the federated area that the particular one or more objects are to be transferred from, the one or more federated devices may be caused by the transfer routine stored therein to repeatedly check whether the specified condition(s) have been met, and if so, to then transfer copies of the particular one or more objects into the transfer area. Within the federated area that the particular one or more objects are to be transferred to, the one or more federated devices may be caused by the transfer routine stored therein to repeatedly check whether copies of the particular one or more objects have been transferred into the transfer area, and if so, to then retrieve the copies of the particular one or more objects from the transfer area.

[0226] A condition that triggers such automated transfers may be any of a variety of conditions that may eventually be met through one or more performances of a job flow within the federated area from which one or more objects are to be so transferred. More specifically, the condition may be the successful generation of particular results data that may include a data set that meets one or more requirements that are specified as the condition. Alternatively, the condition may be the successful generation and/or testing of a new task routine such that there is confirmation in a result report or in the generation of one or more particular data sets that the new task routine has been successfully verified as meeting one or more requirements that are specified as the condition. As will be explained in greater detail, the one or more performances of a job flow that may produce an output that causes the condition to be met may occur within one or more processes that may be separate from the process in which a transfer routine is executed to repeatedly check whether the condition has been met. Also, each of such processes may be performed on a different thread of execution of a processor of a federated device, or each of such processes may be performed on a different thread of execution of a different processor from among multiple processors of either a single federated device or multiple federated devices.

[0227] By way of example, multiple users may be involved in the development of a new neural network or a new ensemble of neural networks (e.g., a chain of neural networks), and each such user may have a different role to play in such a development effort. While the new neural network or neural network ensemble is being developed through a training process, it may be deemed desirable to maintain the data set(s) of weights and biases that is being generated through numerous iterations of training within a first intervening federated area to which access is granted to a relatively small number of users that are directly involved in that training effort. Upon completion of such training, a copy of the resulting one or more data sets of weights and biases may be transferred to a second intervening federated area to which access is granted to a different relatively small

number of users that may be involved in testing the neural network or neural network ensemble defined by the data set(s) to evaluate fitness for release for at least experimental use. The transfer of the copy of one or more data set(s) from the first intervening federated area to the second intervening federated area may be triggered by the training having reached a stage at which a predetermined condition is met that defines the completion of training, such as a quantity of iterations of training having been performed. Upon completion of such testing of the neural network or neural network ensemble, a copy of the one or more data sets of weights and biases may be transferred from the second intervening federated area to a third intervening federated area to which access is granted to yet another relatively small number of users that may be involved in pre-release experimental use of the neural network or neural network ensemble to further verify functionality in actual use case scenarios. Like the transfer to the second intervening federated area, the transfer of a copy of the one or more data sets from the second intervening federated area to the third intervening federated area may be triggered by the testing having reached a stage at which a predetermined condition was met that defines the completion of testing, such as a threshold of a characteristic of performance of the neural network or neural network ensemble having been determined to have been met during testing. Upon completion of such experimental use, a copy of the one or more data sets of weights and biases may be transferred from the third federated area to a base federated area to which access is granted to a larger number of users that may be the intended users of the new neural network.

[0228] Such a neural network or neural network ensemble may be generated as part of an effort to transition from performing a particular analytical function using non-neuromorphic processing (i.e., processing in which no neural network is used) to performing the same analytical function using neuromorphic processing (i.e., processing in which one or more neural networks are used). Such a transition may represent a tradeoff in accuracy for speed, as the performance of the analytical function using neuromorphic processing may not achieve the perfect accuracy (or at least the degree of accuracy) that is possible via the performance of the analytical function using non-neuromorphic processing, but the performance of the analytical function using neuromorphic processing may be faster by one or more orders of magnitude, depending on whether the neural network or neural network ensemble is implemented with software-based simulations of artificial neurons executed by one or more CPUs or GPUs, or hardware-based implementations of artificial neurons provided by one or more neuromorphic devices.

[0229] Where the testing of such a neural network or neural network ensemble progresses successfully such that it begins to be put to actual use, there may be a gradual transition from the testing to the usage that may be automatically implemented in a staged manner. Initially, non-neuromorphic and neuromorphic implementations of the analytical function may be performed at least partially in parallel with the same input data values being provided to both, and with the corresponding output data values of each being compared to test the degree of accuracy of the neural network or neural network ensemble in performing the analytical function. In such initial, at least partially parallel, performances, priority may be given to providing processing resources to the non-neuromorphic implementation, since

the non-neuromorphic implementation is still the one that is in use. As the neural network or neural network ensemble demonstrates a degree of accuracy that at least meets a predetermined threshold, the testing may change such that the neuromorphic implementation is used, and priority is given to providing processing resources to it, while the non-neuromorphic implementation is used at least partially in parallel solely to provide output data values for further comparisons to corresponding ones provided by the neuromorphic implementation. Presuming that the neural network or neural network ensemble continues to demonstrate a degree of accuracy that meets or exceeds the predetermined threshold, further use of the non-neuromorphic implementation of the analytical function may cease, entirely.

[0230] In various embodiments, a somewhat similar temporary relationship may be instantiated between one or more selected federated areas and a storage space that is entirely external to the one or more federated devices and/or to the one or more federated areas, such as an external storage space maintained by a source device or a reviewing device. The federated area(s) selected for such a relationship may, again, include private federated area(s) and/or other federated area(s) used to store one or more objects that may be under development and/or associated with an analysis routine that may be under development. The purpose of such a relationship may be to cause the automatic synchronization of changes made to objects stored within each of the selected federated area(s) and the external storage space, as previously discussed. In some of such embodiments, automatic synchronization may be effected simply by transferring a copy of an object modified within a transfer area within a federated to a corresponding transfer area within the external storage space and vice versa such that both transfer areas are caused to have identical objects.

[0231] As with the aforescribed automatic transfers between transfer areas defined within federated areas, any of a variety of conditions may be specified as the trigger for causing such automated transfers, such as the aforementioned examples of the successful completion of testing of an object (e.g., a task routine) and/or of a neural network (or an ensemble of neural networks) as a trigger. As an alternate example, the trigger may be an instance in which an object is in some way marked or otherwise indicated as having been completed to a degree that a developer working in one of these development environments desires to make it available to the other developers working in the other of these development environments. Such marking may be associated with a process in which an object and/or changes thereto are “committed” to a pool of other objects stored within a transfer area that have also been deemed and marked as similarly complete. Thus, upon an object having been so marked in one transfer area, the one or more federated devices may cause a copy thereof to be transferred to other transfer area with which the one transfer area is synchronized and to be similarly marked such that the fact of that object (or changes made thereto) having been “committed” is made evident at both transfer areas.

[0232] It should be noted that, unlike the one or more federated areas maintained by the one or more federated devices with the aforementioned set of rules that enforce conditions on when objects may be stored within federated area(s) and/or removed therefrom, there may be no such set of rules that are employed to provide similar restrictions for such an external storage space. Thus, synchronization

between one or more selected federated areas and such an external storage space may necessitate providing the ability to at least temporarily suspend the enforcement of such rules for the one or more selected federated areas, at least where new objects and/or changes to objects are effected by the occurrence of transfers from the external storage space and to one of the one or more selected federated areas. It may be that the formation of such a relationship between each of the one or more selected federated areas and an external storage space is limited to private federated area(s) so as to avoid having a federated area in which there is such a suspension of rules that also becomes a federated area from which other federated areas may inherit objects. Alternatively or additionally, it may be that a portion of each of the one or more selected federated areas is designated as a transfer area that becomes the portion thereof in which the contents therein are kept synchronized with a corresponding transfer area within the external storage space.

[0233] In such example embodiments as are described above in which a selected federated area and the external storage space are both employed as shared storage spaces to enable the collaborative development of objects among multiple developers, such transfers to synchronize the conditions of objects therebetween may be performed bi-directionally such that changes to objects made within either location are reflected in the corresponding objects within the other location. As will be explained in greater detail, in embodiments in which such a collaboration is intended to result in the generation of a full set of objects needed to perform a job flow within the one or more federated areas, it may be that there are limits imposed on the bi-directionality of the exchanges such that, for example, job flow definitions may be exchanged bi-directionally, but not task routines. This may be the case where the developers who access the external storage space, but not the one or more federated areas, may be generating task routines and/or job flow definitions in a different programming language from the developers who access the one or more federated areas. Thus, in such a collaboration, task routines that may be accepted from the external storage space through such a synchronization relationship, but no task routines developed within the one or more federated areas may be transmitted back to the external storage space. In contrast, the job flow definition that defines the job flow under development may be transferred in either direction between to enable both groups of developers to be guided by the definition of the job flow therein and/or to enable either of these two groups of developers to modify it as the job flow evolves throughout its development.

[0234] There may be other embodiments in which an external storage space is used to disseminate new objects among multiple persons and/or entities that do not have access to the selected one or more federated areas, and the transfers to synchronize the conditions of objects therebetween may be entirely unidirectional from the designated federated area and to the external storage space. More specifically, it may be that fully developed and tested objects deemed ready for widespread dissemination for use by others are caused to be stored within the designated federated area (or within a portion thereof that is designated as a transfer area), and the fact that such an object has been stored therein may be used as the trigger to cause the automatic transfer of a copy of that object to the external

storage space, while in contrast, there may be no automated transfers of objects back to the federated area from the external storage space.

[0235] Regardless of the exact manner in which objects are received by the one or more federated devices for storage in a federated area, it may be that at least some of those received objects may be written in a variety of different programming languages. More specifically, while some objects may be received that are written in a primary programming language that is normally expected to be interpreted by the one or more federated devices during a performance of a job flow (e.g., the SAS programming language), other objects may be received that may be written in one of a pre-selected set of secondary programming languages the one or more federated devices may also be capable of interpreting during a performance of a job flow (e.g., C, R, Python™).

[0236] As will be explained in greater detail, it may be deemed desirable to provide support for objects written in such secondary language(s) to enable programmers who are unfamiliar with the primary language to nonetheless avail themselves of the various benefits of federated areas. Additionally, supporting such secondary languages may enable programmers who are unfamiliar with the primary language and/or the features of federated areas, the highly structured nature of federated areas and/or the writing of programs for a many-task computing environment to still be able to collaborate with other programmers who are familiar therewith.

[0237] As part of supporting the use of one or more secondary programming languages, some limited degree of translation of programming languages may be performed on portions of objects received by the one or more federated devices. More specifically, the one or more federated devices may automatically translate portion(s) of a job flow definition that defines input and/or output interfaces for each task specified as part of its job flow, and/or may translate portion(s) of a task routine that implement input and/or output interfaces. Such translations may be from both the primary programming language and any of the pre-selected secondary programming languages, and into a single type of intermediate representation, such as an intermediate data structure or an intermediate programming language. An example intermediate programming language that may be so used may be JavaScript Object Notation (JSON) promulgated by ECMA International of Geneva, Switzerland. This may enable comparisons to be made among specifications and/or implementations of input and/or output interfaces to be performed, regardless of which of the programming languages were used to write the specifications and/or implementations of those input and/or output interfaces. In this way, multiple programming languages are able to be accommodated while still using such comparisons to enforce the earlier described rules that may be used to limit what job flow definitions and/or task routines may be permitted to be stored within the one or more federated areas.

[0238] In some embodiments, the performance of translations from the primary programming language and/or secondary programming language(s) may be limited to such translations of specifications and/or implementations of input and/or output interfaces into such an intermediate representation for such comparisons. It may be deemed undesirable and/or unnecessary to translate other portions of

task routines and/or job flow definitions to perform such comparisons and/or for any other purpose.

[0239] However, in other embodiments, it may be deemed desirable to perform translations to the extent needed to derive a task routine written in the primary programming language from a task routine written in a secondary programming language. This may be deemed desirable to enable developers who are generating objects required for a job flow in the primary programming language to have access to a version of the job flow definition that is also written in the primary programming to serve as a guide for their work and/or to enable them to make modifications thereto. In embodiments in which it is just the portion(s) of a job flow that define input and/or output interfaces that are written in a particular programming language, the translation thereof into the intermediate representation (e.g., an intermediate programming language) may be used as the basis for translations between primary and secondary programming languages. More specifically, where a job flow definition is received in which portion(s) that define input and/or output interfaces are written in a secondary programming language, the intermediate representation into which those portion(s) are translated to enable the aforescribed comparisons may also be used as the basis to generate corresponding portion(s) that define the input and/or output interfaces in the primary language as part of a translated form of the job flow definition. In such embodiments, it may be translated form of the job flow definition that is then stored, instead of the originally received job flow definition.

[0240] Additionally, in such embodiments in which a translated form of a job flow definition with input and/or output interface definitions in the primary language may be generated from an originally received job flow definition that includes input and/or output interface definitions in a secondary language, it may be that such translations are performed bi-directionally as part of further supporting a collaboration among a combination of developers in which both the primary and secondary languages are used. More specifically, where a job flow definition in which input and/or output interface definitions are written in the primary language, an intermediate representation into which those portion(s) are translated to enable the aforescribed comparisons may also be used as the basis to generate corresponding input and/or output interface definitions in a secondary programming language. Such a reverse translation may be performed regardless of whether the job flow definition with input and/or output definitions was originally written in the primary programming language, or was translated into the primary programming language from an originally received job flow definition written in a secondary programming language. This may be deemed desirable to enable developers who are generating objects required for a job flow in a secondary programming language to have access to a version of the job flow definition that is also written in the secondary programming to serve as a guide for their work and/or to enable them to make modifications thereto.

[0241] By providing such translations of a job flow definition back and forth between the primary programming language and a secondary programming language, either the developers who write in the primary programming language or the developers who write in the secondary programming language are able to read and/or edit the job flow definition in their chosen programming language. In this way, the

developers using the secondary programming language are put on a more equal footing as collaborators with the developers using the primary programming language as developers of either group are able to participate in shaping the definition of the job flow to which both groups are contributing objects.

[0242] As previously discussed, in some embodiments, a job flow definition may additionally include executable GUI instructions to implement a GUI interface that is to be provided during a performance of the job flow that is defined therein. In such embodiments, it may be deemed desirable to provide more extensive translation capabilities to enable the translation of GUI instructions between programming languages as part of providing a translated form of a job flow definition with input and/or output definitions, and also GUI instructions, written in the primary programming language from a received job flow definition with input and/or output definitions, and also GUI instructions, written in a secondary programming language, and vice versa.

[0243] In various embodiments, a set of objects needed to perform an analysis may effectively be provided to the one or more federated devices in the form of a complex data structure such as a spreadsheet data structure. Such a data structure may contain the equivalent of one or more data sets organized as two-dimensional arrays (e.g., tables) therein, may contain one or more calculations of the analysis organized as multiple equations that may each be stored in a separate row, and/or may specify one or more graphs that are to be presented based on a performance of the analysis. The one or more federated devices may interpret such a data structure to derive therefrom the set of objects needed to perform the analysis defined within the data structure as a job flow in which the analysis is divided into tasks that are each performed as a result of executing a corresponding task routine.

[0244] More precisely, the multiple equations within the data structure may be analyzed, along with the organization of the data into one or more two-dimensional arrays within the data structure, to derive definitions of input and output interfaces for each of the equations and to identify each distinct data object. The multiple equations may also be analyzed, in view of the derived input and/or output interface definitions, to identify the dependencies thereamong. Various checks may be made for instances of mismatched interfaces, missing data that is required as input and/or unused data to determine whether the contents of the data structure set forth analysis a complete analysis that is able to be performed. Presuming that the analysis is determined to be performable, a job flow definition may be derived based on the input and/or output interfaces and the identified dependencies in which each of the equations may be treated as a task of the job flow that is defined by the job flow definition. Each equation may be parsed to generate a corresponding task routine to perform the task of that equation, as specified in the job flow definition. Each identified data object may be generated from a two-dimensional array or a portion of a two-dimensional array within the data structure. This set of generated data objects may then be stored within the federated area into which it was requested that the data structure be stored. In some embodiments, the data structure, itself, may also be stored within the federated area as a measure to provide accountability for the quality of the conversion of the data structure into the set of objects.

[0245] In various embodiments, the one or more federated devices may receive a request to provide one or more related objects together in a packaged form that incorporates one or more features that enable the establishment of one or more new federated areas that contain the related objects within the requesting device or within another device to which the packaged form may be relayed. In some embodiments, the packaged form may be that of a “zip” file in which the one or more related objects are compressed together into a single file that may also include executable code that enables the file to decompress itself, and in so doing, may also instantiate the one or more new federated areas. Such a packaged form may additionally include various executable routines and/or data structures (e.g., indications of hash values, such as checksum values, etc.) that enable the integrity of the one or more related objects to be confirmed, and/or that enable job flows based on the one or more related objects to be performed. In generating the packaged form, the one or more federated devices may employ various criteria specified in the request for which objects are to be provided in the packaged form to confirm that the objects so provided are a complete enough set of objects as to enable any job flow that may be defined by those objects to be properly performed.

[0246] In various embodiments, one or more of comments descriptive of input and/or output interfaces within one or more task routines, portions of instructions within one or more task routines that implement input and/or output interfaces, and specifications of input and/or output interfaces provided in one or more job flow definitions may be used to generate a DAG of one or more task routines and/or of a job flow. More precisely, such information may be used to build any of a variety of data structure(s) that correlate inputs and/or outputs to tasks and/or the task routines that are to perform those tasks, and from which a DAG for one or more task routines and/or a job flow may be generated and/or visually presented. In some embodiments, such a data structure may include script generated in a markup language and/or a block of programming code for each task or task routine (e.g., a macro employing syntax from any of a variety of programming languages). Regardless of the form of the data structure(s) that are generated, such a data structure may also specify the task routine identifier assigned to each task routine and/or the flow task identifier identifying the task performed by each task routine.

[0247] Which one or more task routines are to be included in such a DAG may be specified in any of a variety of ways. By way of example, a request may be received for a DAG that includes one or more tasks or task routines that are explicitly identified by their respective flow task identifiers and/or task routine identifiers. By way of another example, a request may be received for a DAG that includes all of the task routines currently stored within a federated area that may be specified by a URL. By way of still another example, a request may be received for a DAG that includes task routines for all of the tasks identified within a specified job flow definition. And, by way of yet another example, a request may be received for a DAG that includes all of the task routines specified by their identifiers in an instance log of a previous performance of a job flow. Regardless of the exact manner in which one or more tasks and/or task routines may be specified in a request for inclusion within a DAG, each task routine that is directly identified or that is specified indirectly through the flow task identifier of the

task it performs may be searched for within one or more federated areas as earlier described.

[0248] In situations in which a DAG is requested that is to include multiple tasks and/or task routines, the DAG may be generated to indicate any dependencies thereamong. In some embodiments, a visualization of the DAG may be generated to provide a visual indication of such a dependency, such as a line, arrow, color coding, graphical symbols and/or other form of visual connector indicative of the dependency may be generated within the visualization to visually link an output of the one task routine to an input of the other. In embodiments in which the parsing of task routines and/or of job flows includes comparisons between pieces of information that may result in the detection of discrepancies in such details as dependencies among tasks and/or among task routines, such discrepancies may be visually indicated in a DAG in any of a variety of ways. By way of example, a DAG may be generated to indicate such discrepancies with color coding, graphical symbols and/or other form of visual indicator positioned at or adjacent to the graphical depiction of the affected input or output in the DAG. Such a visual indicator may thereby serve as a visual prompt to personnel viewing the DAG to access the affected task routine(s) and/or affected job flow definition to examine and/or correct the discrepancy. Alternatively or additionally, at least a pair of alternate DAGs may be generated, and personnel may be provided with a user interface (UI) that enables “toggling” therebetween and/or a side-by-side comparison, where one DAG is based on the details of inputs and/or outputs provided by comments while another DAG is based on the manner in which those details are actually implemented in executable code.

[0249] In some embodiments, with a DAG generated and visually presented for viewing by personnel involved in the development of new task routines and/or new job flow definitions, such personnel may be provided with a UI that enables editing of the DAG. More specifically, a UI may be provided that enables depicted dependencies between inputs and outputs of task routines to be removed or otherwise changed, and/or that enables new dependencies to be added. Through the provision of such a UI, personnel involved in the development of new task routines and/or new job flow definitions may be able to define a new job flow by modifying a DAG generated from one or more task routines. Indeed, the one or more task routines may be selected for inclusion in a DAG for the purpose of having them available in the DAG for inclusion in the new job flow. Regardless of whether or not a DAG generated from one or more task routines is edited as has just been described, a UI may be provided to enable personnel to choose to save the DAG as a new job flow definition. Regardless of whether the DAG is saved for use as a job flow definition, or simply to retain the DAG for future reference, the DAG may be stored as a script generated in a process description language such as business process model and notation (BPMN) promulgated by the Object Management Group of Needham, Mass., USA.

[0250] As an alternative to receiving a request to generate a DAG based on at least one or more task routines, a request may be received by one or more federated devices from another device to provide the other device with objects needed to enable the other device to so generate a DAG. In some embodiments, such a request may be treated in a manner similar to earlier described requests to retrieve

objects needed to enable another device to perform a job flow with most recent versions of task routines or to repeat a past performance of a job flow, as documented by an instance log. However, in some embodiments, the data structure(s) generated from parsing task routines and/or a job flow definition may be transmitted to the other device in lieu of transmitting the task routines, themselves. This may be deemed desirable as a mechanism to reduce the quantity of information transmitted to the other device for its use in generating a DAG.

[0251] Regardless of whether a requested DAG is to include a depiction of a single task routine or of multiple task routines, it may be that, prior to the receipt of the request for the DAG, one or more of the task routines to be depicted therein may have been test executed to observe their input/output behavior within a container environment as previously described. As also previously discussed, an indication of the input/output behavior observed under such container environment conditions for each task routine so tested may be stored in any of a variety of ways to enable its subsequent retrieval. It may be that an indication of the input/output behavior that was observed may be positioned next to the depiction of a corresponding task routine within the requested DAG.

[0252] In embodiments that use a resource allocation routine to distribute resources to support MTC through the instantiation of containers and/or pods across multiple devices and/or VMs, the generation of complex DAGs and/or other forms of visualization may be at least partially performed by actually using MTC. More specifically, where at least some tasks are of a task type that requires access to particular specialized resources provided by just a subset of federated devices, it may be that generating views of objects that are in some way associated with such task types requires the performance of at least some tasks within such a subset of devices in order to have access to those specialized resources. Such specialized resources may include, and are not limited to, specialized processing components (e.g., GPUs or neuromorphic devices) incorporated into that subset, decryption and/or decompression components incorporated into that subset, decryption and/or decompression routines licensed for use only within that subset, and/or data objects licensed to be accessible only through that subset.

[0253] As part of enabling the use of task routines executed within such federated devices to generate a desired view of a specified object, it may be that a job flow definition that describes a job flow for generating that view is automatically generated in response to receiving the request for that view. A request for the generation of such a job flow definition may be stored on a job queue in a manner very much like a request for a performance of a job flow that is described in an already existing job flow definition. Such a job flow generation request may be relayed from the job queue and onto a task queue to enable being claimed by a task pod and/or container that is instantiated within one of the federated devices of such a subset of federated devices such that the particular resource(s) that are needed are available for use in fulfilling the request to generate the new job flow for generating the requested view.

[0254] Within such task pod and/or container may be an instance of an interpreting routine that would otherwise normally be used in executing task routines, but is, instead, used to analyze various aspects of executable code, inline comments, data values and/or other content within the

specified object. The job flow definition for generating the requested view may then be generated within the task pod and/or container based on such analyses of the content of the specified object, thereby defining a job flow for the generation of the requested view. The newly generated job flow definition may then be conveyed in completion messages back through the task and job queues to be made available for use, and then, a job performance request to perform the flow defined by that job flow definition may be stored on the job queue to thereby cause the requested view of the specified object to actually be generated.

[0255] Upon completion of the generation of the requested view of the specified object, the newly generated view may then be transmitted back to the device from which the original request to generate the view was received. In some embodiments, it may be that the newly generated job flow definition is stored within a federated area as part of providing accountability for its generation. Alternatively, the newly generated job flow definition for generating the requested view may be discarded following provision of that requested view to the device from which the request was received.

[0256] With general reference to notations and nomenclature used herein, portions of the detailed description that follows may be presented in terms of program procedures executed by a processor of a machine or of multiple networked machines. These procedural descriptions and representations are used by those skilled in the art to most effectively convey the substance of their work to others skilled in the art. A procedure is here, and generally, conceived to be a self-consistent sequence of operations leading to a desired result. These operations are those requiring physical manipulations of physical quantities. Usually, though not necessarily, these quantities take the form of electrical, magnetic or optical communications capable of being stored, transferred, combined, compared, and otherwise manipulated. It proves convenient at times, principally for reasons of common usage, to refer to what is communicated as bits, values, elements, symbols, characters, terms, numbers, or the like. It should be noted, however, that all of these and similar terms are to be associated with the appropriate physical quantities and are merely convenient labels applied to those quantities.

[0257] Further, these manipulations are often referred to in terms, such as adding or comparing, which are commonly associated with mental operations performed by a human operator. However, no such capability of a human operator is necessary, or desirable in most cases, in any of the operations described herein that form part of one or more embodiments. Rather, these operations are machine operations. Useful machines for performing operations of various embodiments include machines selectively activated or configured by a routine stored within that is written in accordance with the teachings herein, and/or include apparatus specially constructed for the required purpose. Various embodiments also relate to apparatus or systems for performing these operations. These apparatus may be specially constructed for the required purpose or may include a general purpose computer. The required structure for a variety of these machines will appear from the description given.

[0258] Reference is now made to the drawings, wherein like reference numerals are used to refer to like elements throughout. In the following description, for purposes of

explanation, numerous specific details are set forth in order to provide a thorough understanding thereof. It may be evident, however, that the novel embodiments can be practiced without these specific details. In other instances, well known structures and devices are shown in block diagram form in order to facilitate a description thereof. The intention is to cover all modifications, equivalents, and alternatives within the scope of the claims.

[0259] Systems depicted in some of the figures may be provided in various configurations. In some embodiments, the systems may be configured as a distributed system where one or more components of the system are distributed across one or more networks in a cloud computing system and/or a fog computing system.

[0260] FIG. 1 is a block diagram that provides an illustration of the hardware components of a data transmission network 100, according to embodiments of the present technology. Data transmission network 100 is a specialized computer system that may be used for processing large amounts of data where a large number of computer processing cycles are required.

[0261] Data transmission network 100 may also include computing environment 114. Computing environment 114 may be a specialized computer or other machine that processes the data received within the data transmission network 100. Data transmission network 100 also includes one or more network devices 102. Network devices 102 may include client devices that attempt to communicate with computing environment 114. For example, network devices 102 may send data to the computing environment 114 to be processed, may send signals to the computing environment 114 to control different aspects of the computing environment or the data it is processing, among other reasons. Network devices 102 may interact with the computing environment 114 through a number of ways, such as, for example, over one or more networks 108. As shown in FIG. 1, computing environment 114 may include one or more other systems. For example, computing environment 114 may include a database system 118 and/or a communications grid 120.

[0262] In other embodiments, network devices may provide a large amount of data, either all at once or streaming over a period of time (e.g., using event stream processing (ESP), described further with respect to FIGS. 8-10), to the computing environment 114 via networks 108. For example, network devices 102 may include network computers, sensors, databases, or other devices that may transmit or otherwise provide data to computing environment 114. For example, network devices may include local area network devices, such as routers, hubs, switches, or other computer networking devices. These devices may provide a variety of stored or generated data, such as network data or data specific to the network devices themselves. Network devices may also include sensors that monitor their environment or other devices to collect data regarding that environment or those devices, and such network devices may provide data they collect over time. Network devices may also include devices within the internet of things, such as devices within a home automation network. Some of these devices may be referred to as edge devices, and may involve edge computing circuitry. Data may be transmitted by network devices directly to computing environment 114 or to network-attached data stores, such as network-attached data stores

110 for storage so that the data may be retrieved later by the computing environment 114 or other portions of data transmission network 100.

[0263] Data transmission network 100 may also include one or more network-attached data stores 110. Network-attached data stores 110 are used to store data to be processed by the computing environment 114 as well as any intermediate or final data generated by the computing system in non-volatile memory. However in certain embodiments, the configuration of the computing environment 114 allows its operations to be performed such that intermediate and final data results can be stored solely in volatile memory (e.g., RAM), without a requirement that intermediate or final data results be stored to non-volatile types of memory (e.g., disk). This can be useful in certain situations, such as when the computing environment 114 receives ad hoc queries from a user and when responses, which are generated by processing large amounts of data, need to be generated on-the-fly. In this non-limiting situation, the computing environment 114 may be configured to retain the processed information within memory so that responses can be generated for the user at different levels of detail as well as allow a user to interactively query against this information.

[0264] Network-attached data stores may store a variety of different types of data organized in a variety of different ways and from a variety of different sources. For example, network-attached data storage may include storage other than primary storage located within computing environment 114 that is directly accessible by processors located therein. Network-attached data storage may include secondary, tertiary or auxiliary storage, such as large hard drives, servers, virtual memory, among other types. Storage devices may include portable or non-portable storage devices, optical storage devices, and various other mediums capable of storing, containing data. A machine-readable storage medium or computer-readable storage medium may include a non-transitory medium in which data can be stored and that does not include carrier waves and/or transitory electronic signals. Examples of a non-transitory medium may include, for example, a magnetic disk or tape, optical storage media such as compact disk or digital versatile disk, flash memory, memory or memory devices. A computer-program product may include code and/or machine-executable instructions that may represent a procedure, a function, a subprogram, a program, a routine, a subroutine, a module, a software package, a class, or any combination of instructions, data structures, or program statements. A code segment may be coupled to another code segment or a hardware circuit by passing and/or receiving information, data, arguments, parameters, or memory contents. Information, arguments, parameters, data, etc. may be passed, forwarded, or transmitted via any suitable means including memory sharing, message passing, token passing, network transmission, among others. Furthermore, the data stores may hold a variety of different types of data. For example, network-attached data stores 110 may hold unstructured (e.g., raw) data, such as manufacturing data (e.g., a database containing records identifying products being manufactured with parameter data for each product, such as colors and models) or product sales databases (e.g., a database containing individual data records identifying details of individual product sales).

[0265] The unstructured data may be presented to the computing environment 114 in different forms such as a flat

file or a conglomerate of data records, and may have data values and accompanying time stamps. The computing environment **114** may be used to analyze the unstructured data in a variety of ways to determine the best way to structure (e.g., hierarchically) that data, such that the structured data is tailored to a type of further analysis that a user wishes to perform on the data. For example, after being processed, the unstructured time stamped data may be aggregated by time (e.g., into daily time period units) to generate time series data and/or structured hierarchically according to one or more dimensions (e.g., parameters, attributes, and/or variables). For example, data may be stored in a hierarchical data structure, such as a ROLAP OR MOLAP database, or may be stored in another tabular form, such as in a flat-hierarchy form.

[0266] Data transmission network **100** may also include one or more server farms **106**. Computing environment **114** may route select communications or data to the one or more sever farms **106** or one or more servers within the server farms. Server farms **106** can be configured to provide information in a predetermined manner. For example, server farms **106** may access data to transmit in response to a communication. Server farms **106** may be separately housed from each other device within data transmission network **100**, such as computing environment **114**, and/or may be part of a device or system.

[0267] Server farms **106** may host a variety of different types of data processing as part of data transmission network **100**. Server farms **106** may receive a variety of different data from network devices, from computing environment **114**, from cloud network **116**, or from other sources. The data may have been obtained or collected from one or more sensors, as inputs from a control database, or may have been received as inputs from an external system or device. Server farms **106** may assist in processing the data by turning raw data into processed data based on one or more rules implemented by the server farms. For example, sensor data may be analyzed to determine changes in an environment over time or in real-time.

[0268] Data transmission network **100** may also include one or more cloud networks **116**. Cloud network **116** may include a cloud infrastructure system that provides cloud services. In certain embodiments, services provided by the cloud network **116** may include a host of services that are made available to users of the cloud infrastructure system on demand. Cloud network **116** is shown in FIG. 1 as being connected to computing environment **114** (and therefore having computing environment **114** as its client or user), but cloud network **116** may be connected to or utilized by any of the devices in FIG. 1. Services provided by the cloud network can dynamically scale to meet the needs of its users. The cloud network **116** may include one or more computers, servers, and/or systems. In some embodiments, the computers, servers, and/or systems that make up the cloud network **116** are different from the user's own on-premises computers, servers, and/or systems. For example, the cloud network **116** may host an application, and a user may, via a communication network such as the Internet, on demand, order and use the application.

[0269] While each device, server and system in FIG. 1 is shown as a single device, it will be appreciated that multiple devices may instead be used. For example, a set of network devices can be used to transmit various communications

from a single user, or remote server **140** may include a server stack. As another example, data may be processed as part of computing environment **114**.

[0270] Each communication within data transmission network **100** (e.g., between client devices, between servers **106** and computing environment **114** or between a server and a device) may occur over one or more networks **108**. Networks **108** may include one or more of a variety of different types of networks, including a wireless network, a wired network, or a combination of a wired and wireless network. Examples of suitable networks include the Internet, a personal area network, a local area network (LAN), a wide area network (WAN), or a wireless local area network (WLAN). A wireless network may include a wireless interface or combination of wireless interfaces. As an example, a network in the one or more networks **108** may include a short-range communication channel, such as a BLUETOOTH® communication channel or a BLUETOOTH® Low Energy communication channel. A wired network may include a wired interface. The wired and/or wireless networks may be implemented using routers, access points, bridges, gateways, or the like, to connect devices in the network **114**, as will be further described with respect to FIG. 2. The one or more networks **108** can be incorporated entirely within or can include an intranet, an extranet, or a combination thereof. In one embodiment, communications between two or more systems and/or devices can be achieved by a secure communications protocol, such as secure sockets layer (SSL) or transport layer security (TLS). In addition, data and/or transactional details may be encrypted.

[0271] Some aspects may utilize the Internet of Things (IoT), where things (e.g., machines, devices, phones, sensors) can be connected to networks and the data from these things can be collected and processed within the things and/or external to the things. For example, the IoT can include sensors in many different devices, and high value analytics can be applied to identify hidden relationships and drive increased efficiencies. This can apply to both big data analytics and real-time (e.g., ESP) analytics. This will be described further below with respect to FIG. 2.

[0272] As noted, computing environment **114** may include a communications grid **120** and a transmission network database system **118**. Communications grid **120** may be a grid-based computing system for processing large amounts of data. The transmission network database system **118** may be for managing, storing, and retrieving large amounts of data that are distributed to and stored in the one or more network-attached data stores **110** or other data stores that reside at different locations within the transmission network database system **118**. The compute nodes in the grid-based computing system **120** and the transmission network database system **118** may share the same processor hardware, such as processors that are located within computing environment **114**.

[0273] FIG. 2 illustrates an example network including an example set of devices communicating with each other over an exchange system and via a network, according to embodiments of the present technology. As noted, each communication within data transmission network **100** may occur over one or more networks. System **200** includes a network device **204** configured to communicate with a variety of types of client devices, for example client devices **230**, over a variety of types of communication channels.

[0274] As shown in FIG. 2, network device 204 can transmit a communication over a network (e.g., a cellular network via a base station 210). The communication can be routed to another network device, such as network devices 205-209, via base station 210. The communication can also be routed to computing environment 214 via base station 210. For example, network device 204 may collect data either from its surrounding environment or from other network devices (such as network devices 205-209) and transmit that data to computing environment 214.

[0275] Although network devices 204-209 are shown in FIG. 2 as a mobile phone, laptop computer, tablet computer, temperature sensor, motion sensor, and audio sensor respectively, the network devices may be or include sensors that are sensitive to detecting aspects of their environment. For example, the network devices may include sensors such as water sensors, power sensors, electrical current sensors, chemical sensors, optical sensors, pressure sensors, geographic or position sensors (e.g., GPS), velocity sensors, acceleration sensors, flow rate sensors, among others. Examples of characteristics that may be sensed include force, torque, load, strain, position, temperature, air pressure, fluid flow, chemical properties, resistance, electromagnetic fields, radiation, irradiance, proximity, acoustics, moisture, distance, speed, vibrations, acceleration, electrical potential, electrical current, among others. The sensors may be mounted to various components used as part of a variety of different types of systems (e.g., an oil drilling operation). The network devices may detect and record data related to the environment that it monitors, and transmit that data to computing environment 214.

[0276] As noted, one type of system that may include various sensors that collect data to be processed and/or transmitted to a computing environment according to certain embodiments includes an oil drilling system. For example, the one or more drilling operation sensors may include surface sensors that measure a hook load, a fluid rate, a temperature and a density in and out of the wellbore, a standpipe pressure, a surface torque, a rotation speed of a drill pipe, a rate of penetration, a mechanical specific energy, etc. and downhole sensors that measure a rotation speed of a bit, fluid densities, downhole torque, downhole vibration (axial, tangential, lateral), a weight applied at a drill bit, an annular pressure, a differential pressure, an azimuth, an inclination, a dog leg severity, a measured depth, a vertical depth, a downhole temperature, etc. Besides the raw data collected directly by the sensors, other data may include parameters either developed by the sensors or assigned to the system by a client or other controlling device. For example, one or more drilling operation control parameters may control settings such as a mud motor speed to flow ratio, a bit diameter, a predicted formation top, seismic data, weather data, etc. Other data may be generated using physical models such as an earth model, a weather model, a seismic model, a bottom hole assembly model, a well plan model, an annular friction model, etc. In addition to sensor and control settings, predicted outputs, of for example, the rate of penetration, mechanical specific energy, hook load, flow in fluid rate, flow out fluid rate, pump pressure, surface torque, rotation speed of the drill pipe, annular pressure, annular friction pressure, annular temperature, equivalent circulating density, etc. may also be stored in the data warehouse.

[0277] In another example, another type of system that may include various sensors that collect data to be processed and/or transmitted to a computing environment according to certain embodiments includes a home automation or similar automated network in a different environment, such as an office space, school, public space, sports venue, or a variety of other locations. Network devices in such an automated network may include network devices that allow a user to access, control, and/or configure various home appliances located within the user's home (e.g., a television, radio, light, fan, humidifier, sensor, microwave, iron, and/or the like), or outside of the user's home (e.g., exterior motion sensors, exterior lighting, garage door openers, sprinkler systems, or the like). For example, network device 102 may include a home automation switch that may be coupled with a home appliance. In another embodiment, a network device can allow a user to access, control, and/or configure devices, such as office-related devices (e.g., copy machine, printer, or fax machine), audio and/or video related devices (e.g., a receiver, a speaker, a projector, a DVD player, or a television), media-playback devices (e.g., a compact disc player, a CD player, or the like), computing devices (e.g., a home computer, a laptop computer, a tablet, a personal digital assistant (PDA), a computing device, or a wearable device), lighting devices (e.g., a lamp or recessed lighting), devices associated with a security system, devices associated with an alarm system, devices that can be operated in an automobile (e.g., radio devices, navigation devices), and/or the like. Data may be collected from such various sensors in raw form, or data may be processed by the sensors to create parameters or other data either developed by the sensors based on the raw data or assigned to the system by a client or other controlling device.

[0278] In another example, another type of system that may include various sensors that collect data to be processed and/or transmitted to a computing environment according to certain embodiments includes a power or energy grid. A variety of different network devices may be included in an energy grid, such as various devices within one or more power plants, energy farms (e.g., wind farm, solar farm, among others) energy storage facilities, factories, homes and businesses of consumers, among others. One or more of such devices may include one or more sensors that detect energy gain or loss, electrical input or output or loss, and a variety of other efficiencies. These sensors may collect data to inform users of how the energy grid, and individual devices within the grid, may be functioning and how they may be made more efficient.

[0279] Network device sensors may also perform processing on data it collects before transmitting the data to the computing environment 114, or before deciding whether to transmit data to the computing environment 114. For example, network devices may determine whether data collected meets certain rules, for example by comparing data or values calculated from the data and comparing that data to one or more thresholds. The network device may use this data and/or comparisons to determine if the data should be transmitted to the computing environment 214 for further use or processing.

[0280] Computing environment 214 may include machines 220 and 240. Although computing environment 214 is shown in FIG. 2 as having two machines, 220 and 240, computing environment 214 may have only one machine or may have more than two machines. The

machines that make up computing environment **214** may include specialized computers, servers, or other machines that are configured to individually and/or collectively process large amounts of data. The computing environment **214** may also include storage devices that include one or more databases of structured data, such as data organized in one or more hierarchies, or unstructured data. The databases may communicate with the processing devices within computing environment **214** to distribute data to them. Since network devices may transmit data to computing environment **214**, that data may be received by the computing environment **214** and subsequently stored within those storage devices. Data used by computing environment **214** may also be stored in data stores **235**, which may also be a part of or connected to computing environment **214**.

[0281] Computing environment **214** can communicate with various devices via one or more routers **225** or other inter-network or intra-network connection components. For example, computing environment **214** may communicate with devices **230** via one or more routers **225**. Computing environment **214** may collect, analyze and/or store data from or pertaining to communications, client device operations, client rules, and/or user-associated actions stored at one or more data stores **235**. Such data may influence communication routing to the devices within computing environment **214**, how data is stored or processed within computing environment **214**, among other actions.

[0282] Notably, various other devices can further be used to influence communication routing and/or processing between devices within computing environment **214** and with devices outside of computing environment **214**. For example, as shown in FIG. 2, computing environment **214** may include a web server **240**. Thus, computing environment **214** can retrieve data of interest, such as client information (e.g., product information, client rules, etc.), technical product details, news, current or predicted weather, and so on.

[0283] In addition to computing environment **214** collecting data (e.g., as received from network devices, such as sensors, and client devices or other sources) to be processed as part of a big data analytics project, it may also receive data in real time as part of a streaming analytics environment. As noted, data may be collected using a variety of sources as communicated via different kinds of networks or locally. Such data may be received on a real-time streaming basis. For example, network devices may receive data periodically from network device sensors as the sensors continuously sense, monitor and track changes in their environments. Devices within computing environment **214** may also perform pre-analysis on data it receives to determine if the data received should be processed as part of an ongoing project. The data received and collected by computing environment **214**, no matter what the source or method or timing of receipt, may be processed over a period of time for a client to determine results data based on the client's needs and rules.

[0284] FIG. 3 illustrates a representation of a conceptual model of a communications protocol system, according to embodiments of the present technology. More specifically, FIG. 3 identifies operation of a computing environment in an Open Systems Interaction model that corresponds to various connection components. The model **300** shows, for example, how a computing environment, such as computing environment **314** (or computing environment **214** in FIG. 2) may

communicate with other devices in its network, and control how communications between the computing environment and other devices are executed and under what conditions. **[0285]** The model can include layers **301-307**. The layers are arranged in a stack. Each layer in the stack serves the layer one level higher than it (except for the application layer, which is the highest layer), and is served by the layer one level below it (except for the physical layer, which is the lowest layer). The physical layer is the lowest layer because it receives and transmits raw bites of data, and is the farthest layer from the user in a communications system. On the other hand, the application layer is the highest layer because it interacts directly with a software application.

[0286] As noted, the model includes a physical layer **301**. Physical layer **301** represents physical communication, and can define parameters of that physical communication. For example, such physical communication may come in the form of electrical, optical, or electromagnetic signals. Physical layer **301** also defines protocols that may control communications within a data transmission network.

[0287] Link layer **302** defines links and mechanisms used to transmit (i.e., move) data across a network. The link layer **302** manages node-to-node communications, such as within a grid computing environment. Link layer **302** can detect and correct errors (e.g., transmission errors in the physical layer **301**). Link layer **302** can also include a media access control (MAC) layer and logical link control (LLC) layer.

[0288] Network layer **303** defines the protocol for routing within a network. In other words, the network layer coordinates transferring data across nodes in a same network (e.g., such as a grid computing environment). Network layer **303** can also define the processes used to structure local addressing within the network.

[0289] Transport layer **304** can manage the transmission of data and the quality of the transmission and/or receipt of that data. Transport layer **304** can provide a protocol for transferring data, such as, for example, a Transmission Control Protocol (TCP). Transport layer **304** can assemble and disassemble data frames for transmission. The transport layer can also detect transmission errors occurring in the layers below it.

[0290] Session layer **305** can establish, maintain, and manage communication connections between devices on a network. In other words, the session layer controls the dialogues or nature of communications between network devices on the network. The session layer may also establish checkpointing, adjournment, termination, and restart procedures.

[0291] Presentation layer **306** can provide translation for communications between the application and network layers. In other words, this layer may encrypt, decrypt and/or format data based on data types and/or encodings known to be accepted by an application or network layer.

[0292] Application layer **307** interacts directly with software applications and end users, and manages communications between them. Application layer **307** can identify destinations, local resource states or availability and/or communication content or formatting using the applications.

[0293] Intra-network connection components **321** and **322** are shown to operate in lower levels, such as physical layer **301** and link layer **302**, respectively. For example, a hub can operate in the physical layer, a switch can operate in the link layer, and a router can operate in the network layer. Inter-network connection components **323** and **328** are shown to

operate on higher levels, such as layers 303-307. For example, routers can operate in the network layer and network devices can operate in the transport, session, presentation, and application layers.

[0294] As noted, a computing environment 314 can interact with and/or operate on, in various embodiments, one, more, all or any of the various layers. For example, computing environment 314 can interact with a hub (e.g., via the link layer) so as to adjust which devices the hub communicates with. The physical layer may be served by the link layer, so it may implement such data from the link layer. For example, the computing environment 314 may control which devices it will receive data from. For example, if the computing environment 314 knows that a certain network device has turned off, broken, or otherwise become unavailable or unreliable, the computing environment 314 may instruct the hub to prevent any data from being transmitted to the computing environment 314 from that network device. Such a process may be beneficial to avoid receiving data that is inaccurate or that has been influenced by an uncontrolled environment. As another example, computing environment 314 can communicate with a bridge, switch, router or gateway and influence which device within the system (e.g., system 200) the component selects as a destination. In some embodiments, computing environment 314 can interact with various layers by exchanging communications with equipment operating on a particular layer by routing or modifying existing communications. In another embodiment, such as in a grid computing environment, a node may determine how data within the environment should be routed (e.g., which node should receive certain data) based on certain parameters or information provided by other layers within the model.

[0295] As noted, the computing environment 314 may be a part of a communications grid environment, the communications of which may be implemented as shown in the protocol of FIG. 3. For example, referring back to FIG. 2, one or more of machines 220 and 240 may be part of a communications grid computing environment. A gridded computing environment may be employed in a distributed system with non-interactive workloads where data resides in memory on the machines, or compute nodes. In such an environment, analytic code, instead of a database management system, controls the processing performed by the nodes. Data is co-located by pre-distributing it to the grid nodes, and the analytic code on each node loads the local data into memory. Each node may be assigned a particular task such as a portion of a processing project, or to organize or control other nodes within the grid.

[0296] FIG. 4 illustrates a communications grid computing system 400 including a variety of control and worker nodes, according to embodiments of the present technology. Communications grid computing system 400 includes three control nodes and one or more worker nodes. Communications grid computing system 400 includes control nodes 402, 404, and 406. The control nodes are communicatively connected via communication paths 451, 453, and 455. Therefore, the control nodes may transmit information (e.g., related to the communications grid or notifications), to and receive information from each other. Although communications grid computing system 400 is shown in FIG. 4 as including three control nodes, the communications grid may include more or less than three control nodes.

[0297] Communications grid computing system (or just “communications grid”) 400 also includes one or more worker nodes. Shown in FIG. 4 are six worker nodes 410-420. Although FIG. 4 shows six worker nodes, a communications grid according to embodiments of the present technology may include more or less than six worker nodes. The number of worker nodes included in a communications grid may be dependent upon how large the project or data set is being processed by the communications grid, the capacity of each worker node, the time designated for the communications grid to complete the project, among others. Each worker node within the communications grid 400 may be connected (wired or wirelessly, and directly or indirectly) to control nodes 402-406. Therefore, each worker node may receive information from the control nodes (e.g., an instruction to perform work on a project) and may transmit information to the control nodes (e.g., a result from work performed on a project). Furthermore, worker nodes may communicate with each other (either directly or indirectly). For example, worker nodes may transmit data between each other related to a job being performed or an individual task within a job being performed by that worker node. However, in certain embodiments, worker nodes may not, for example, be connected (communicatively or otherwise) to certain other worker nodes. In an embodiment, worker nodes may only be able to communicate with the control node that controls it, and may not be able to communicate with other worker nodes in the communications grid, whether they are other worker nodes controlled by the control node that controls the worker node, or worker nodes that are controlled by other control nodes in the communications grid.

[0298] A control node may connect with an external device with which the control node may communicate (e.g., a grid user, such as a server or computer, may connect to a controller of the grid). For example, a server or computer may connect to control nodes and may transmit a project or job to the node. The project may include a data set. The data set may be of any size. Once the control node receives such a project including a large data set, the control node may distribute the data set or projects related to the data set to be performed by worker nodes. Alternatively, for a project including a large data set, the data set may be received or stored by a machine other than a control node (e.g., a HADOOP® standard-compliant data node employing the HADOOP® distributed file system, or HDFS).

[0299] Control nodes may maintain knowledge of the status of the nodes in the grid (i.e., grid status information), accept work requests from clients, subdivide the work across worker nodes, coordinate the worker nodes, among other responsibilities. Worker nodes may accept work requests from a control node and provide the control node with results of the work performed by the worker node. A grid may be started from a single node (e.g., a machine, computer, server, etc.). This first node may be assigned or may start as the primary control node that will control any additional nodes that enter the grid.

[0300] When a project is submitted for execution (e.g., by a client or a controller of the grid) it may be assigned to a set of nodes. After the nodes are assigned to a project, a data structure (i.e., a communicator) may be created. The communicator may be used by the project for information to be shared between the project code running on each node. A communication handle may be created on each node. A handle, for example, is a reference to the communicator that

is valid within a single process on a single node, and the handle may be used when requesting communications between nodes.

[0301] A control node, such as control node **402**, may be designated as the primary control node. A server, computer or other external device may connect to the primary control node. Once the control node receives a project, the primary control node may distribute portions of the project to its worker nodes for execution. For example, when a project is initiated on communications grid **400**, primary control node **402** controls the work to be performed for the project in order to complete the project as requested or instructed. The primary control node may distribute work to the worker nodes based on various factors, such as which subsets or portions of projects may be completed most efficiently and in the correct amount of time. For example, a worker node may perform analysis on a portion of data that is already local (e.g., stored on) the worker node. The primary control node also coordinates and processes the results of the work performed by each worker node after each worker node executes and completes its job. For example, the primary control node may receive a result from one or more worker nodes, and the control node may organize (e.g., collect and assemble) the results received and compile them to produce a complete result for the project received from the end user.

[0302] Any remaining control nodes, such as control nodes **404** and **406**, may be assigned as backup control nodes for the project. In an embodiment, backup control nodes may not control any portion of the project. Instead, backup control nodes may serve as a backup for the primary control node and take over as primary control node if the primary control node were to fail. If a communications grid were to include only a single control node, and the control node were to fail (e.g., the control node is shut off or breaks) then the communications grid as a whole may fail and any project or job being run on the communications grid may fail and may not complete. While the project may be run again, such a failure may cause a delay (severe delay in some cases, such as overnight delay) in completion of the project. Therefore, a grid with multiple control nodes, including a backup control node, may be beneficial.

[0303] To add another node or machine to the grid, the primary control node may open a pair of listening sockets, for example. A socket may be used to accept work requests from clients, and the second socket may be used to accept connections from other grid nodes. The primary control node may be provided with a list of other nodes (e.g., other machines, computers, servers) that will participate in the grid, and the role that each node will fill in the grid. Upon startup of the primary control node (e.g., the first node on the grid), the primary control node may use a network protocol to start the server process on every other node in the grid. Command line parameters, for example, may inform each node of one or more pieces of information, such as: the role that the node will have in the grid, the host name of the primary control node, the port number on which the primary control node is accepting connections from peer nodes, among others. The information may also be provided in a configuration file, transmitted over a secure shell tunnel, recovered from a configuration server, among others. While the other machines in the grid may not initially know about the configuration of the grid, that information may also be

sent to each other node by the primary control node. Updates of the grid information may also be subsequently sent to those nodes.

[0304] For any control node other than the primary control node added to the grid, the control node may open three sockets. The first socket may accept work requests from clients, the second socket may accept connections from other grid members, and the third socket may connect (e.g., permanently) to the primary control node. When a control node (e.g., primary control node) receives a connection from another control node, it first checks to see if the peer node is in the list of configured nodes in the grid. If it is not on the list, the control node may clear the connection. If it is on the list, it may then attempt to authenticate the connection. If authentication is successful, the authenticating node may transmit information to its peer, such as the port number on which a node is listening for connections, the host name of the node, information about how to authenticate the node, among other information. When a node, such as the new control node, receives information about another active node, it will check to see if it already has a connection to that other node. If it does not have a connection to that node, it may then establish a connection to that control node.

[0305] Any worker node added to the grid may establish a connection to the primary control node and any other control nodes on the grid. After establishing the connection, it may authenticate itself to the grid (e.g., any control nodes, including both primary and backup, or a server or user controlling the grid). After successful authentication, the worker node may accept configuration information from the control node.

[0306] When a node joins a communications grid (e.g., when the node is powered on or connected to an existing node on the grid or both), the node is assigned (e.g., by an operating system of the grid) a universally unique identifier (UUID). This unique identifier may help other nodes and external entities (devices, users, etc.) to identify the node and distinguish it from other nodes. When a node is connected to the grid, the node may share its unique identifier with the other nodes in the grid. Since each node may share its unique identifier, each node may know the unique identifier of every other node on the grid. Unique identifiers may also designate a hierarchy of each of the nodes (e.g., backup control nodes) within the grid. For example, the unique identifiers of each of the backup control nodes may be stored in a list of backup control nodes to indicate an order in which the backup control nodes will take over for a failed primary control node to become a new primary control node. However, a hierarchy of nodes may also be determined using methods other than using the unique identifiers of the nodes. For example, the hierarchy may be predetermined, or may be assigned based on other predetermined factors.

[0307] The grid may add new machines at any time (e.g., initiated from any control node). Upon adding a new node to the grid, the control node may first add the new node to its table of grid nodes. The control node may also then notify every other control node about the new node. The nodes receiving the notification may acknowledge that they have updated their configuration information.

[0308] Primary control node **402** may, for example, transmit one or more communications to backup control nodes **404** and **406** (and, for example, to other control or worker nodes within the communications grid). Such communications may be sent periodically, at fixed time intervals, between

known fixed stages of the project's execution, among other protocols. The communications transmitted by primary control node 402 may be of varied types and may include a variety of types of information. For example, primary control node 402 may transmit snapshots (e.g., status information) of the communications grid so that backup control node 404 always has a recent snapshot of the communications grid. The snapshot or grid status may include, for example, the structure of the grid (including, for example, the worker nodes in the grid, unique identifiers of the nodes, or their relationships with the primary control node) and the status of a project (including, for example, the status of each worker node's portion of the project). The snapshot may also include analysis or results received from worker nodes in the communications grid. The backup control nodes may receive and store the backup data received from the primary control node. The backup control nodes may transmit a request for such a snapshot (or other information) from the primary control node, or the primary control node may send such information periodically to the backup control nodes.

[0309] As noted, the backup data may allow the backup control node to take over as primary control node if the primary control node fails without requiring the grid to start the project over from scratch. If the primary control node fails, the backup control node that will take over as primary control node may retrieve the most recent version of the snapshot received from the primary control node and use the snapshot to continue the project from the stage of the project indicated by the backup data. This may prevent failure of the project as a whole.

[0310] A backup control node may use various methods to determine that the primary control node has failed. In one example of such a method, the primary control node may transmit (e.g., periodically) a communication to the backup control node that indicates that the primary control node is working and has not failed, such as a heartbeat communication. The backup control node may determine that the primary control node has failed if the backup control node has not received a heartbeat communication for a certain predetermined period of time. Alternatively, a backup control node may also receive a communication from the primary control node itself (before it failed) or from a worker node that the primary control node has failed, for example because the primary control node has failed to communicate with the worker node.

[0311] Different methods may be performed to determine which backup control node of a set of backup control nodes (e.g., backup control nodes 404 and 406) will take over for failed primary control node 402 and become the new primary control node. For example, the new primary control node may be chosen based on a ranking or "hierarchy" of backup control nodes based on their unique identifiers. In an alternative embodiment, a backup control node may be assigned to be the new primary control node by another device in the communications grid or from an external device (e.g., a system infrastructure or an end user, such as a server or computer, controlling the communications grid). In another alternative embodiment, the backup control node that takes over as the new primary control node may be designated based on bandwidth or other statistics about the communications grid.

[0312] A worker node within the communications grid may also fail. If a worker node fails, work being performed by the failed worker node may be redistributed amongst the

operational worker nodes. In an alternative embodiment, the primary control node may transmit a communication to each of the operable worker nodes still on the communications grid that each of the worker nodes should purposefully fail also. After each of the worker nodes fail, they may each retrieve their most recent saved checkpoint of their status and re-start the project from that checkpoint to minimize lost progress on the project being executed.

[0313] FIG. 5 illustrates a flow chart showing an example process 500 for adjusting a communications grid or a work project in a communications grid after a failure of a node, according to embodiments of the present technology. The process may include, for example, receiving grid status information including a project status of a portion of a project being executed by a node in the communications grid, as described in operation 502. For example, a control node (e.g., a backup control node connected to a primary control node and a worker node on a communications grid) may receive grid status information, where the grid status information includes a project status of the primary control node or a project status of the worker node. The project status of the primary control node and the project status of the worker node may include a status of one or more portions of a project being executed by the primary and worker nodes in the communications grid. The process may also include storing the grid status information, as described in operation 504. For example, a control node (e.g., a backup control node) may store the received grid status information locally within the control node. Alternatively, the grid status information may be sent to another device for storage where the control node may have access to the information.

[0314] The process may also include receiving a failure communication corresponding to a node in the communications grid in operation 506. For example, a node may receive a failure communication including an indication that the primary control node has failed, prompting a backup control node to take over for the primary control node. In an alternative embodiment, a node may receive a failure that a worker node has failed, prompting a control node to reassign the work being performed by the worker node. The process may also include reassigning a node or a portion of the project being executed by the failed node, as described in operation 508. For example, a control node may designate the backup control node as a new primary control node based on the failure communication upon receiving the failure communication. If the failed node is a worker node, a control node may identify a project status of the failed worker node using the snapshot of the communications grid, where the project status of the failed worker node includes a status of a portion of the project being executed by the failed worker node at the failure time.

[0315] The process may also include receiving updated grid status information based on the reassignment, as described in operation 510, and transmitting a set of instructions based on the updated grid status information to one or more nodes in the communications grid, as described in operation 512. The updated grid status information may include an updated project status of the primary control node or an updated project status of the worker node. The updated information may be transmitted to the other nodes in the grid to update their stale stored information.

[0316] FIG. 6 illustrates a portion of a communications grid computing system 600 including a control node and a worker node, according to embodiments of the present

technology. Communications grid 600 computing system includes one control node (control node 602) and one worker node (worker node 610) for purposes of illustration, but may include more worker and/or control nodes. The control node 602 is communicatively connected to worker node 610 via communication path 650. Therefore, control node 602 may transmit information (e.g., related to the communications grid or notifications), to and receive information from worker node 610 via path 650.

[0317] Similar to in FIG. 4, communications grid computing system (or just “communications grid”) 600 includes data processing nodes (control node 602 and worker node 610). Nodes 602 and 610 include multi-core data processors. Each node 602 and 610 includes a grid-enabled software component (GESC) 620 that executes on the data processor associated with that node and interfaces with buffer memory 622 also associated with that node. Each node 602 and 610 includes a database management software (DBMS) 628 that executes on a database server (not shown) at control node 602 and on a database server (not shown) at worker node 610.

[0318] Each node also includes a data store 624. Data stores 624, similar to network-attached data stores 110 in FIG. 1 and data stores 235 in FIG. 2, are used to store data to be processed by the nodes in the computing environment. Data stores 624 may also store any intermediate or final data generated by the computing system after being processed, for example in non-volatile memory. However in certain embodiments, the configuration of the grid computing environment allows its operations to be performed such that intermediate and final data results can be stored solely in volatile memory (e.g., RAM), without a requirement that intermediate or final data results be stored to non-volatile types of memory. Storing such data in volatile memory may be useful in certain situations, such as when the grid receives queries (e.g., ad hoc) from a client and when responses, which are generated by processing large amounts of data, need to be generated quickly or on-the-fly. In such a situation, the grid may be configured to retain the data within memory so that responses can be generated at different levels of detail and so that a client may interactively query against this information.

[0319] Each node also includes a user-defined function (UDF) 626. The UDF provides a mechanism for the DBMS 628 to transfer data to or receive data from the database stored in the data stores 624 that are managed by the DBMS. For example, UDF 626 can be invoked by the DBMS to provide data to the GESC for processing. The UDF 626 may establish a socket connection (not shown) with the GESC to transfer the data. Alternatively, the UDF 626 can transfer data to the GESC by writing data to shared memory accessible by both the UDF and the GESC.

[0320] The GESC 620 at the nodes 602 and 620 may be connected via a network, such as network 108 shown in FIG. 1. Therefore, nodes 602 and 620 can communicate with each other via the network using a predetermined communication protocol such as, for example, the Message Passing Interface (MPI). Each GESC 620 can engage in point-to-point communication with the GESC at another node or in collective communication with multiple GESCs via the network. The GESC 620 at each node may contain identical (or nearly identical) software instructions. Each node may be capable of operating as either a control node or a worker node. The GESC at the control node 602 can communicate, over a

communication path 652, with a client device 630. More specifically, control node 602 may communicate with client application 632 hosted by the client device 630 to receive queries and to respond to those queries after processing large amounts of data.

[0321] DBMS 628 may control the creation, maintenance, and use of database or data structure (not shown) within a nodes 602 or 610. The database may organize data stored in data stores 624. The DBMS 628 at control node 602 may accept requests for data and transfer the appropriate data for the request. With such a process, collections of data may be distributed across multiple physical locations. In this example, each node 602 and 610 stores a portion of the total data managed by the management system in its associated data store 624.

[0322] Furthermore, the DBMS may be responsible for protecting against data loss using replication techniques. Replication includes providing a backup copy of data stored on one node on one or more other nodes. Therefore, if one node fails, the data from the failed node can be recovered from a replicated copy residing at another node. However, as described herein with respect to FIG. 4, data or status information for each node in the communications grid may also be shared with each node on the grid.

[0323] FIG. 7 illustrates a flow chart showing an example method 700 for executing a project within a grid computing system, according to embodiments of the present technology. As described with respect to FIG. 6, the GESC at the control node may transmit data with a client device (e.g., client device 630) to receive queries for executing a project and to respond to those queries after large amounts of data have been processed. The query may be transmitted to the control node, where the query may include a request for executing a project, as described in operation 702. The query can contain instructions on the type of data analysis to be performed in the project and whether the project should be executed using the grid-based computing environment, as shown in operation 704.

[0324] To initiate the project, the control node may determine if the query requests use of the grid-based computing environment to execute the project. If the determination is no, then the control node initiates execution of the project in a solo environment (e.g., at the control node), as described in operation 710. If the determination is yes, the control node may initiate execution of the project in the grid-based computing environment, as described in operation 706. In such a situation, the request may include a requested configuration of the grid. For example, the request may include a number of control nodes and a number of worker nodes to be used in the grid when executing the project. After the project has been completed, the control node may transmit results of the analysis yielded by the grid, as described in operation 708. Whether the project is executed in a solo or grid-based environment, the control node provides the results of the project, as described in operation 712.

[0325] As noted with respect to FIG. 2, the computing environments described herein may collect data (e.g., as received from network devices, such as sensors, such as network devices 204-209 in FIG. 2, and client devices or other sources) to be processed as part of a data analytics project, and data may be received in real time as part of a streaming analytics environment (e.g., ESP). Data may be collected using a variety of sources as communicated via different kinds of networks or locally, such as on a real-time

streaming basis. For example, network devices may receive data periodically from network device sensors as the sensors continuously sense, monitor and track changes in their environments. More specifically, an increasing number of distributed applications develop or produce continuously flowing data from distributed sources by applying queries to the data before distributing the data to geographically distributed recipients. An event stream processing engine (ESPE) may continuously apply the queries to the data as it is received and determines which entities should receive the data. Client or other devices may also subscribe to the ESPE or other devices processing ESP data so that they can receive data after processing, based on for example the entities determined by the processing engine. For example, client devices **230** in FIG. 2 may subscribe to the ESPE in computing environment **214**. In another example, event subscription devices **1024a-c**, described further with respect to FIG. 10, may also subscribe to the ESPE. The ESPE may determine or define how input data or event streams from network devices or other publishers (e.g., network devices **204-209** in FIG. 2) are transformed into meaningful output data to be consumed by subscribers, such as for example client devices **230** in FIG. 2.

[0326] FIG. 8 illustrates a block diagram including components of an Event Stream Processing Engine (ESPE), according to embodiments of the present technology. ESPE **800** may include one or more projects **802**. A project may be described as a second-level container in an engine model managed by ESPE **800** where a thread pool size for the project may be defined by a user. Each project of the one or more projects **802** may include one or more continuous queries **804** that contain data flows, which are data transformations of incoming event streams. The one or more continuous queries **804** may include one or more source windows **806** and one or more derived windows **808**.

[0327] The ESPE may receive streaming data over a period of time related to certain events, such as events or other data sensed by one or more network devices. The ESPE may perform operations associated with processing data created by the one or more devices. For example, the ESPE may receive data from the one or more network devices **204-209** shown in FIG. 2. As noted, the network devices may include sensors that sense different aspects of their environments, and may collect data over time based on those sensed observations. For example, the ESPE may be implemented within one or more of machines **220** and **240** shown in FIG. 2. The ESPE may be implemented within such a machine by an ESP application. An ESP application may embed an ESPE with its own dedicated thread pool or pools into its application space where the main application thread can do application-specific work and the ESPE processes event streams at least by creating an instance of a model into processing objects.

[0328] The engine container is the top-level container in a model that manages the resources of the one or more projects **802**. In an illustrative embodiment, for example, there may be only one ESPE **800** for each instance of the ESP application, and ESPE **800** may have a unique engine name. Additionally, the one or more projects **802** may each have unique project names, and each query may have a unique continuous query name and begin with a uniquely named source window of the one or more source windows **806**. ESPE **800** may or may not be persistent.

[0329] Continuous query modeling involves defining directed graphs of windows for event stream manipulation and transformation. A window in the context of event stream manipulation and transformation is a processing node in an event stream processing model. A window in a continuous query can perform aggregations, computations, pattern-matching, and other operations on data flowing through the window. A continuous query may be described as a directed graph of source, relational, pattern matching, and procedural windows. The one or more source windows **806** and the one or more derived windows **808** represent continuously executing queries that generate updates to a query result set as new event blocks stream through ESPE **800**. A directed graph, for example, is a set of nodes connected by edges, where the edges have a direction associated with them.

[0330] An event object may be described as a packet of data accessible as a collection of fields, with at least one of the fields defined as a key or unique identifier (ID). The event object may be created using a variety of formats including binary, alphanumeric, XML, etc. Each event object may include one or more fields designated as a primary identifier (ID) for the event so ESPE **800** can support operation codes (opcodes) for events including insert, update, upsert, and delete. Upsert opcodes update the event if the key field already exists; otherwise, the event is inserted. For illustration, an event object may be a packed binary representation of a set of field values and include both metadata and field data associated with an event. The metadata may include an opcode indicating if the event represents an insert, update, delete, or upsert, a set of flags indicating if the event is a normal, partial-update, or a retention generated event from retention policy management, and a set of microsecond timestamps that can be used for latency measurements.

[0331] An event block object may be described as a grouping or package of event objects. An event stream may be described as a flow of event block objects. A continuous query of the one or more continuous queries **804** transforms a source event stream made up of streaming event block objects published into ESPE **800** into one or more output event streams using the one or more source windows **806** and the one or more derived windows **808**. A continuous query can also be thought of as data flow modeling.

[0332] The one or more source windows **806** are at the top of the directed graph and have no windows feeding into them. Event streams are published into the one or more source windows **806**, and from there, the event streams may be directed to the next set of connected windows as defined by the directed graph. The one or more derived windows **808** are all instantiated windows that are not source windows and that have other windows streaming events into them. The one or more derived windows **808** may perform computations or transformations on the incoming event streams. The one or more derived windows **808** transform event streams based on the window type (that is operators such as join, filter, compute, aggregate, copy, pattern match, procedural, union, etc.) and window settings. As event streams are published into ESPE **800**, they are continuously queried, and the resulting sets of derived windows in these queries are continuously updated.

[0333] FIG. 9 illustrates a flow chart showing an example process including operations performed by an event stream processing engine, according to some embodiments of the present technology. As noted, the ESPE **800** (or an associ-

ated ESP application) defines how input event streams are transformed into meaningful output event streams. More specifically, the ESP application may define how input event streams from publishers (e.g., network devices providing sensed data) are transformed into meaningful output event streams consumed by subscribers (e.g., a data analytics project being executed by a machine or set of machines).

[0334] Within the application, a user may interact with one or more user interface windows presented to the user in a display under control of the ESPE independently or through a browser application in an order selectable by the user. For example, a user may execute an ESP application, which causes presentation of a first user interface window, which may include a plurality of menus and selectors such as drop down menus, buttons, text boxes, hyperlinks, etc. associated with the ESP application as understood by a person of skill in the art. As further understood by a person of skill in the art, various operations may be performed in parallel, for example, using a plurality of threads.

[0335] At operation 900, an ESP application may define and start an ESPE, thereby instantiating an ESPE at a device, such as machine 220 and/or 240. In an operation 902, the engine container is created. For illustration, ESPE 800 may be instantiated using a function call that specifies the engine container as a manager for the model.

[0336] In an operation 904, the one or more continuous queries 804 are instantiated by ESPE 800 as a model. The one or more continuous queries 804 may be instantiated with a dedicated thread pool or pools that generate updates as new events stream through ESPE 800. For illustration, the one or more continuous queries 804 may be created to model business processing logic within ESPE 800, to predict events within ESPE 800, to model a physical system within ESPE 800, to predict the physical system state within ESPE 800, etc. For example, as noted, ESPE 800 may be used to support sensor data monitoring and management (e.g., sensing may include force, torque, load, strain, position, temperature, air pressure, fluid flow, chemical properties, resistance, electromagnetic fields, radiation, irradiance, proximity, acoustics, moisture, distance, speed, vibrations, acceleration, electrical potential, or electrical current, etc.).

[0337] ESPE 800 may analyze and process events in motion or “event streams.” Instead of storing data and running queries against the stored data, ESPE 800 may store queries and stream data through them to allow continuous analysis of data as it is received. The one or more source windows 806 and the one or more derived windows 808 may be created based on the relational, pattern matching, and procedural algorithms that transform the input event streams into the output event streams to model, simulate, score, test, predict, etc. based on the continuous query model defined and application to the streamed data.

[0338] In an operation 906, a publish/subscribe (pub/sub) capability is initialized for ESPE 800. In an illustrative embodiment, a pub/sub capability is initialized for each project of the one or more projects 802. To initialize and enable pub/sub capability for ESPE 800, a port number may be provided. Pub/sub clients can use a host name of an ESP device running the ESPE and the port number to establish pub/sub connections to ESPE 800.

[0339] FIG. 10 illustrates an ESP system 1000 interfacing between publishing device 1022 and event subscribing devices 1024a-c, according to embodiments of the present technology. ESP system 1000 may include ESP device or

subsystem 851, event publishing device 1022, an event subscribing device A 1024a, an event subscribing device B 1024b, and an event subscribing device C 1024c. Input event streams are output to ESP device 851 by publishing device 1022. In alternative embodiments, the input event streams may be created by a plurality of publishing devices. The plurality of publishing devices further may publish event streams to other ESP devices. The one or more continuous queries instantiated by ESPE 800 may analyze and process the input event streams to form output event streams output to event subscribing device A 1024a, event subscribing device B 1024b, and event subscribing device C 1024c. ESP system 1000 may include a greater or a fewer number of event subscribing devices of event subscribing devices.

[0340] Publish-subscribe is a message-oriented interaction paradigm based on indirect addressing. Processed data recipients specify their interest in receiving information from ESPE 800 by subscribing to specific classes of events, while information sources publish events to ESPE 800 without directly addressing the receiving parties. ESPE 800 coordinates the interactions and processes the data. In some cases, the data source receives confirmation that the published information has been received by a data recipient.

[0341] A publish/subscribe API may be described as a library that enables an event publisher, such as publishing device 1022, to publish event streams into ESPE 800 or an event subscriber, such as event subscribing device A 1024a, event subscribing device B 1024b, and event subscribing device C 1024c, to subscribe to event streams from ESPE 800. For illustration, one or more publish/subscribe APIs may be defined. Using the publish/subscribe API, an event publishing application may publish event streams into a running event stream processor project source window of ESPE 800, and the event subscription application may subscribe to an event stream processor project source window of ESPE 800.

[0342] The publish/subscribe API provides cross-platform connectivity and endianness compatibility between ESP application and other networked applications, such as event publishing applications instantiated at publishing device 1022, and event subscription applications instantiated at one or more of event subscribing device A 1024a, event subscribing device B 1024b, and event subscribing device C 1024c.

[0343] Referring back to FIG. 9, operation 906 initializes the publish/subscribe capability of ESPE 800. In an operation 908, the one or more projects 802 are started. The one or more started projects may run in the background on an ESP device. In an operation 910, an event block object is received from one or more computing device of the event publishing device 1022.

[0344] ESP subsystem 800 may include a publishing client 1002, ESPE 800, a subscribing client A 1004, a subscribing client B 1006, and a subscribing client C 1008. Publishing client 1002 may be started by an event publishing application executing at publishing device 1022 using the publish/subscribe API. Subscribing client A 1004 may be started by an event subscription application A, executing at event subscribing device A 1024a using the publish/subscribe API. Subscribing client B 1006 may be started by an event subscription application B executing at event subscribing device B 1024b using the publish/subscribe API. Subscribing client C 1008 may be started by an event subscription

application C executing at event subscribing device C **1024c** using the publish/subscribe API.

[0345] An event block object containing one or more event objects is injected into a source window of the one or more source windows **806** from an instance of an event publishing application on event publishing device **1022**. The event block object may generated, for example, by the event publishing application and may be received by publishing client **1002**. A unique ID may be maintained as the event block object is passed between the one or more source windows **806** and/or the one or more derived windows **808** of ESPE **800**, and to subscribing client A **1004**, subscribing client B **1006**, and subscribing client C **1008** and to event subscription device A **1024a**, event subscription device B **1024b**, and event subscription device C **1024c**. Publishing client **1002** may further generate and include a unique embedded transaction ID in the event block object as the event block object is processed by a continuous query, as well as the unique ID that publishing device **1022** assigned to the event block object.

[0346] In an operation **912**, the event block object is processed through the one or more continuous queries **804**. In an operation **914**, the processed event block object is output to one or more computing devices of the event subscribing devices **1024a-c**. For example, subscribing client A **1004**, subscribing client B **1006**, and subscribing client C **1008** may send the received event block object to event subscription device A **1024a**, event subscription device B **1024b**, and event subscription device C **1024c**, respectively.

[0347] ESPE **800** maintains the event block containership aspect of the received event blocks from when the event block is published into a source window and works its way through the directed graph defined by the one or more continuous queries **804** with the various event translations before being output to subscribers. Subscribers can correlate a group of subscribed events back to a group of published events by comparing the unique ID of the event block object that a publisher, such as publishing device **1022**, attached to the event block object with the event block ID received by the subscriber.

[0348] In an operation **916**, a determination is made concerning whether or not processing is stopped. If processing is not stopped, processing continues in operation **910** to continue receiving the one or more event streams containing event block objects from the, for example, one or more network devices. If processing is stopped, processing continues in an operation **918**. In operation **918**, the started projects are stopped. In operation **920**, the ESPE is shut-down.

[0349] As noted, in some embodiments, big data is processed for an analytics project after the data is received and stored. In other embodiments, distributed applications process continuously flowing data in real-time from distributed sources by applying queries to the data before distributing the data to geographically distributed recipients. As noted, an event stream processing engine (ESPE) may continuously apply the queries to the data as it is received and determines which entities receive the processed data. This allows for large amounts of data being received and/or collected in a variety of environments to be processed and distributed in real time. For example, as shown with respect to FIG. 2, data may be collected from network devices that may include devices within the internet of things, such as devices within a home automation network. However, such data may be

collected from a variety of different resources in a variety of different environments. In any such situation, embodiments of the present technology allow for real-time processing of such data.

[0350] Aspects of the current disclosure provide technical solutions to technical problems, such as computing problems that arise when an ESP device fails which results in a complete service interruption and potentially significant data loss. The data loss can be catastrophic when the streamed data is supporting mission critical operations such as those in support of an ongoing manufacturing or drilling operation. An embodiment of an ESP system achieves a rapid and seamless failover of ESPE running at the plurality of ESP devices without service interruption or data loss, thus significantly improving the reliability of an operational system that relies on the live or real-time processing of the data streams. The event publishing systems, the event subscribing systems, and each ESPE not executing at a failed ESP device are not aware of or effected by the failed ESP device. The ESP system may include thousands of event publishing systems and event subscribing systems. The ESP system keeps the failover logic and awareness within the boundaries of out-messaging network connector and out-messaging network device.

[0351] In one example embodiment, a system is provided to support a failover when event stream processing (ESP) event blocks. The system includes, but is not limited to, an out-messaging network device and a computing device. The computing device includes, but is not limited to, a processor and a computer-readable medium operably coupled to the processor. The processor is configured to execute an ESP engine (ESPE). The computer-readable medium has instructions stored thereon that, when executed by the processor, cause the computing device to support the failover. An event block object is received from the ESPE that includes a unique identifier. A first status of the computing device as active or standby is determined. When the first status is active, a second status of the computing device as newly active or not newly active is determined. Newly active is determined when the computing device is switched from a standby status to an active status. When the second status is newly active, a last published event block object identifier that uniquely identifies a last published event block object is determined. A next event block object is selected from a non-transitory computer-readable medium accessible by the computing device. The next event block object has an event block object identifier that is greater than the determined last published event block object identifier. The selected next event block object is published to an out-messaging network device. When the second status of the computing device is not newly active, the received event block object is published to the out-messaging network device. When the first status of the computing device is standby, the received event block object is stored in the non-transitory computer-readable medium.

[0352] FIG. 11 is a flow chart of an example of a process for generating and using a machine-learning model according to some aspects. Machine learning is a branch of artificial intelligence that relates to mathematical models that can learn from, categorize, and make predictions about data. Such mathematical models, which can be referred to as machine-learning models, can classify input data among two or more classes; cluster input data among two or more groups; predict a result based on input data; identify patterns

or trends in input data; identify a distribution of input data in a space; or any combination of these. Examples of machine-learning models can include (i) neural networks; (ii) decision trees, such as classification trees and regression trees; (iii) classifiers, such as Naïve bias classifiers, logistic regression classifiers, ridge regression classifiers, random forest classifiers, least absolute shrinkage and selector (LASSO) classifiers, and support vector machines; (iv) clusterers, such as k-means clusterers, mean-shift clusterers, and spectral clusterers; (v) factorizers, such as factorization machines, principal component analyzers and kernel principal component analyzers; and (vi) ensembles or other combinations of machine-learning models. In some examples, neural networks can include deep neural networks, feed-forward neural networks, recurrent neural networks, convolutional neural networks, radial basis function (RBF) neural networks, echo state neural networks, long short-term memory neural networks, bi-directional recurrent neural networks, gated neural networks, hierarchical recurrent neural networks, stochastic neural networks, modular neural networks, spiking neural networks, dynamic neural networks, cascading neural networks, neuro-fuzzy neural networks, or any combination of these.

[0353] Different machine-learning models may be used interchangeably to perform a task. Examples of tasks that can be performed at least partially using machine-learning models include various types of scoring; bioinformatics; cheminformatics; software engineering; fraud detection; customer segmentation; generating online recommendations; adaptive websites; determining customer lifetime value; search engines; placing advertisements in real time or near real time; classifying DNA sequences; affective computing; performing natural language processing and understanding; object recognition and computer vision; robotic locomotion; playing games; optimization and metaheuristics; detecting network intrusions; medical diagnosis and monitoring; or predicting when an asset, such as a machine, will need maintenance.

[0354] Any number and combination of tools can be used to create machine-learning models. Examples of tools for creating and managing machine-learning models can include SAS® Enterprise Miner, SAS® Rapid Predictive Modeler, and SAS® Model Manager, SAS Cloud Analytic Services (CAS)®, SAS Viya® of all which are by SAS Institute Inc. of Cary, N.C.

[0355] Machine-learning models can be constructed through an at least partially automated (e.g., with little or no human involvement) process called training. During training, input data can be iteratively supplied to a machine-learning model to enable the machine-learning model to identify patterns related to the input data or to identify relationships between the input data and output data. With training, the machine-learning model can be transformed from an untrained state to a trained state. Input data can be split into one or more training sets and one or more validation sets, and the training process may be repeated multiple times. The splitting may follow a k-fold cross-validation rule, a leave-one-out-rule, a leave-p-out rule, or a holdout rule. An overview of training and using a machine-learning model is described below with respect to the flow chart of FIG. 11.

[0356] In block 1104, training data is received. In some examples, the training data is received from a remote database or a local database, constructed from various

subsets of data, or input by a user. The training data can be used in its raw form for training a machine-learning model or pre-processed into another form, which can then be used for training the machine-learning model. For example, the raw form of the training data can be smoothed, truncated, aggregated, clustered, or otherwise manipulated into another form, which can then be used for training the machine-learning model.

[0357] In block 1106, a machine-learning model is trained using the training data. The machine-learning model can be trained in a supervised, unsupervised, or semi-supervised manner. In supervised training, each input in the training data is correlated to a desired output. This desired output may be a scalar, a vector, or a different type of data structure such as text or an image. This may enable the machine-learning model to learn a mapping between the inputs and desired outputs. In unsupervised training, the training data includes inputs, but not desired outputs, so that the machine-learning model has to find structure in the inputs on its own. In semi-supervised training, only some of the inputs in the training data are correlated to desired outputs.

[0358] In block 1108, the machine-learning model is evaluated. For example, an evaluation dataset can be obtained, for example, via user input or from a database. The evaluation dataset can include inputs correlated to desired outputs. The inputs can be provided to the machine-learning model and the outputs from the machine-learning model can be compared to the desired outputs. If the outputs from the machine-learning model closely correspond with the desired outputs, the machine-learning model may have a high degree of accuracy. For example, if 90% or more of the outputs from the machine-learning model are the same as the desired outputs in the evaluation dataset, the machine-learning model may have a high degree of accuracy. Otherwise, the machine-learning model may have a low degree of accuracy. The 90% number is an example only. A realistic and desirable accuracy percentage is dependent on the problem and the data.

[0359] In some examples, if the machine-learning model has an inadequate degree of accuracy for a particular task, the process can return to block 1106, where the machine-learning model can be further trained using additional training data or otherwise modified to improve accuracy. If the machine-learning model has an adequate degree of accuracy for the particular task, the process can continue to block 1110.

[0360] In block 1110, new data is received. In some examples, the new data is received from a remote database or a local database, constructed from various subsets of data, or input by a user. The new data may be unknown to the machine-learning model. For example, the machine-learning model may not have previously processed or analyzed the new data.

[0361] In block 1112, the trained machine-learning model is used to analyze the new data and provide a result. For example, the new data can be provided as input to the trained machine-learning model. The trained machine-learning model can analyze the new data and provide a result that includes a classification of the new data into a particular class, a clustering of the new data into a particular group, a prediction based on the new data, or any combination of these.

[0362] In block 1114, the result is post-processed. For example, the result can be added to, multiplied with, or

otherwise combined with other data as part of a job. As another example, the result can be transformed from a first format, such as a time series format, into another format, such as a count series format. Any number and combination of operations can be performed on the result during post-processing.

[0363] A more specific example of a machine-learning model is the neural network 1200 shown in FIG. 12. The neural network 1200 is represented as multiple layers of interconnected neurons, such as neuron 1208, that can exchange data between one another. The layers include an input layer 1202 for receiving input data, a hidden layer 1204, and an output layer 1206 for providing a result. The hidden layer 1204 is referred to as hidden because it may not be directly observable or have its input directly accessible during the normal functioning of the neural network 1200. Although the neural network 1200 is shown as having a specific number of layers and neurons for exemplary purposes, the neural network 1200 can have any number and combination of layers, and each layer can have any number and combination of neurons.

[0364] The neurons and connections between the neurons can have numeric weights, which can be tuned during training. For example, training data can be provided to the input layer 1202 of the neural network 1200, and the neural network 1200 can use the training data to tune one or more numeric weights of the neural network 1200. In some examples, the neural network 1200 can be trained using backpropagation. Backpropagation can include determining a gradient of a particular numeric weight based on a difference between an actual output of the neural network 1200 and a desired output of the neural network 1200. Based on the gradient, one or more numeric weights of the neural network 1200 can be updated to reduce the difference, thereby increasing the accuracy of the neural network 1200. This process can be repeated multiple times to train the neural network 1200. For example, this process can be repeated hundreds or thousands of times to train the neural network 1200.

[0365] In some examples, the neural network 1200 is a feed-forward neural network. In a feed-forward neural network, every neuron only propagates an output value to a subsequent layer of the neural network 1200. For example, data may only move one direction (forward) from one neuron to the next neuron in a feed-forward neural network.

[0366] In other examples, the neural network 1200 is a recurrent neural network. A recurrent neural network can include one or more feedback loops, allowing data to propagate in both forward and backward through the neural network 1200. This can allow for information to persist within the recurrent neural network. For example, a recurrent neural network can determine an output based at least partially on information that the recurrent neural network has seen before, giving the recurrent neural network the ability to use previous input to inform the output.

[0367] In some examples, the neural network 1200 operates by receiving a vector of numbers from one layer; transforming the vector of numbers into a new vector of numbers using a matrix of numeric weights, a nonlinearity, or both; and providing the new vector of numbers to a subsequent layer of the neural network 1200. Each subsequent layer of the neural network 1200 can repeat this process until the neural network 1200 outputs a final result at the output layer 1206. For example, the neural network

1200 can receive a vector of numbers as an input at the input layer 1202. The neural network 1200 can multiply the vector of numbers by a matrix of numeric weights to determine a weighted vector. The matrix of numeric weights can be tuned during the training of the neural network 1200. The neural network 1200 can transform the weighted vector using a nonlinearity, such as a sigmoid tangent or the hyperbolic tangent. In some examples, the nonlinearity can include a rectified linear unit, which can be expressed using the equation $y = \max(x, 0)$ where y is the output and x is an input value from the weighted vector. The transformed output can be supplied to a subsequent layer, such as the hidden layer 1204, of the neural network 1200. The subsequent layer of the neural network 1200 can receive the transformed output, multiply the transformed output by a matrix of numeric weights and a nonlinearity, and provide the result to yet another layer of the neural network 1200. This process continues until the neural network 1200 outputs a final result at the output layer 1206.

[0368] Other examples of the present disclosure may include any number and combination of machine-learning models having any number and combination of characteristics. The machine-learning model(s) can be trained in a supervised, semi-supervised, or unsupervised manner, or any combination of these. The machine-learning model(s) can be implemented using a single computing device or multiple computing devices, such as the communications grid computing system 400 discussed above.

[0369] Implementing some examples of the present disclosure at least in part by using machine-learning models can reduce the total number of processing iterations, time, memory, electrical power, or any combination of these consumed by a computing device when analyzing data. For example, a neural network may more readily identify patterns in data than other approaches. This may enable the neural network to analyze the data using fewer processing cycles and less memory than other approaches, while obtaining a similar or greater level of accuracy.

[0370] Some machine-learning approaches may be more efficiently and speedily executed and processed with machine-learning specific processors (e.g., not a generic CPU). Such processors may also provide an energy savings when compared to generic CPUs. For example, some of these processors can include a graphical processing unit (GPU), an application-specific integrated circuit (ASIC), a field-programmable gate array (FPGA), an artificial intelligence (AI) accelerator, a neural computing core, a neural computing engine, a neural processing unit, a purpose-built chip architecture for deep learning, and/or some other machine-learning specific processor that implements a machine learning approach or one or more neural networks using semiconductor (e.g., silicon (Si), gallium arsenide (GaAs)) devices. These processors may also be employed in heterogeneous computing architectures with a number of and a variety of different types of cores, engines, nodes, and/or layers to achieve various energy efficiencies, processing speed improvements, data communication speed improvements, and/or data efficiency targets and improvements throughout various parts of the system when compared to a homogeneous computing architecture that employs CPUs for general purpose computing.

[0371] FIG. 13A is a block diagram of an example embodiment of a distributed processing system 2000 incorporating one or more source devices 2100, one or more

reviewing devices **2800**, one or more federated devices **2500** that may form a federated device grid **2005**, and/or one or more storage devices **2600** that may form a storage device grid **2006**. FIG. **13B** illustrates exchanges, through a network **2999**, of communications among the devices **2100**, **2500**, **2600** and/or **2800** associated with the controlled storage of and/or access to various objects within one or more federated areas **2566**, and/or the performance of job flows of analyses associated therewith. FIG. **13C** illustrates embodiments in which such exchanges are performed in response to requests from the devices **2100** and/or **2800**. FIG. **13D** illustrates embodiments in which such exchanges are performed as part of a pre-arranged synchronization of storage spaces among the devices **2100**, **2500**, **2600** and/or **2800**. FIG. **13E** illustrates an embodiment in which virtual machines (VMs) **2505** are instantiated within at least the federated devices **2500**. FIGS. **13F-H** illustrate various embodiments of the manner in which such objects may be caused to be stored as a result of such exchanges.

[**0372**] Referring to both FIGS. **13A** and **13B**, communications among the devices **2100**, **2500**, **2600** and/or **2800** may include the exchange of objects for the performance of job flows, such as job flow definitions **2220**, directed acyclic graphs (DAGs) **2270**, data sets **2330** and/or **2370**, task routines **2440**, macros **2470** and/or result reports **2770**. The purposes for such exchanges may be simply to store such objects within one or more federated areas **2566** and/or to retrieve such objects therefrom, and/or to trigger performances of job flows using such objects. However, one or more of the devices **2100**, **2500**, **2600** and/or **2800** may also exchange, via the network **2999**, other data entirely unrelated to any object stored within any federated area **2566**. In various embodiments, the network **2999** may be a single network that may extend within a single building or other relatively limited area, a combination of connected networks that may extend a considerable distance, and/or may include the Internet. Thus, the network **2999** may be based on any of a variety (or combination) of communications technologies by which communications may be effected, including without limitation, wired technologies employing electrically and/or optically conductive cabling, and wireless technologies employing infrared, radio frequency (RF) or other forms of wireless transmission.

[**0373**] In various embodiments, each of the one or more source devices **2100** may incorporate one or more of an input device **2110**, a display **2180**, a processor **2150**, a storage **2160** and a network interface **2190** to couple each of the one or more source devices **2100** to the network **2999**. The storage **2160** may store a control routine **2140**, one or more job flow definitions **2220**, one or more DAGs **2270**, one or more data sets **2330**, one or more task routines **2440** and/or one or more macros **2470**. The control routine **2140** may incorporate a sequence of instructions operative on the processor **2150** of each of the one or more source devices **2100** to implement logic to perform various functions. In embodiments in which multiple ones of the source devices **2100** are operated together as a grid of the source devices **2100**, the sequence of instructions of the control routine **2140** may be operative on the processor **2150** of each of those source devices **2100** to perform various functions at least partially in parallel with the processors **2150** of others of the source devices **2100**.

[**0374**] In some embodiments, one or more of the source devices **2100** may be operated by persons and/or entities

(e.g., scholastic entities, governmental entities, business entities, etc.) to generate and/or maintain analysis routines, that when executed by one or more processors, causes an analysis of data to be performed. In such embodiments, execution of the control routine **2140** may cause the processor **2150** to operate the input device **2110** and/or the display **2180** to provide a user interface (UI) by which an operator of the source device **2100** may use the source device **2100** to develop such analysis routines and/or to test their functionality by causing the processor **2150** to execute such routines. As will be explained in greater detail, a rule imposed in connection with such use of a federated area **2566** may be that routines to be stored and/or executed therein are required to be divided up into a combination of a set of objects, including a set of task routines **2440** and a job flow definition **2220**. Each of the task routines **2440** performs a distinct task, and the job flow definition **2220** defines the analysis to be performed as a job flow as a combination of tasks to be performed in a particular order through the execution of the set of task routines **2440** in that particular order to thereby perform the job flow. Thus, the source device **2100** may be used in generating such objects which may then be stored within one or more federated areas **2566**.

[**0375**] The tasks that each of the task routines **2440** may cause a processor to perform may include any of a variety of data analysis tasks, data transformation tasks and/or data normalization tasks. The data analysis tasks may include, and are not limited to, searches and/or statistical analyses that entail derivation of approximations, numerical characterizations, models, evaluations of hypotheses, and/or predictions (e.g., a prediction by Bayesian analysis of actions of a crowd trying to escape a burning building, or of the behavior of bridge components in response to a wind forces). The data transformation tasks may include, and are not limited to, sorting, row and/or column-based mathematical operations, row and/or column-based filtering using one or more data items of a row or column, and/or reordering data items within a data object. The data normalization tasks may include, and are not limited to, normalizing times of day, dates, monetary values (e.g., normalizing to a single unit of currency), character spacing, use of delimiter characters (e.g., normalizing use of periods and commas in numeric values), use of formatting codes, use of big or little Endian encoding, use or lack of use of sign bits, quantities of bits used to represent integers and/or floating point values (e.g., bytes, words, doublewords or quadwords), etc.

[**0376**] In some embodiments, the UI provided by one or more of the source devices **2100** may take the form of a touch-sensitive device paired with a stylus that serves to enable sketch input by an operator of a source device **2100**. As will be familiar to those skilled in the art, this may entail the combining of the display **2180** and the input device **2110** into a single UI device that is able to provide visual feedback to the operator of the successful sketch entry of visual tokens and of text. Through such sketch input, the operator may specify aspects of a GUI that is to be provided during a performance of a job flow to provide an easier and more intuitive user interface by which a user may provide input needed for the performance of that job flow. Following recognition and interpretation of the visual tokens and/or text within the sketch input, a set of executable GUI instructions to implement the GUI may be stored as part of a job flow definition **2220** for such a job flow.

[0377] In some embodiments, one or more of the source devices 2100 may, alternatively or additionally, serve to assemble one or more flow input data sets 2330. In such embodiments, execution of the control routine 2140 by the processor 2150 may cause the processor 2150 to operate the network interface 2190, the input device 2110 and/or one or more other components (not shown) to receive data items and to assemble those received data items into one or more of the data sets 2330. By way of example, one or more of the source devices 2100 may incorporate and/or be in communication with one or more sensors to receive data items associated with the monitoring of natural phenomena (e.g., geological or meteorological events) and/or with the performance of a scientific or other variety of experiment (e.g., a thermal camera or sensors disposed about a particle accelerator). By way of another example, the processor 2150 of one or more of the source devices 2100 may be caused by its execution of the control routine 2140 to operate the network interface 2190 to await transmissions via the network 2999 from one or more other devices providing at least a portion of at least one data set 2330.

[0378] Regardless of the exact manner in which flow input data sets 2330 are generated, each flow input data set 2330 may include any of a wide variety of types of data associated with any of a wide variety of subjects. By way of example, each flow input data set 2330 may include scientific observation data concerning geological and/or meteorological events, or from sensors employed in laboratory experiments in areas such as particle physics. By way of another example, the each flow input data set 2330 may include indications of activities performed by a random sample of individuals of a population of people in a selected country or municipality, or of a population of a threatened species under study in the wild.

[0379] In various embodiments, each of the one or more reviewing devices 2800 may incorporate one or more of an input device 2810, a display 2880, a processor 2850, a storage 2860 and a network interface 2890 to couple each of the one or more reviewing devices 2800 to the network 2999. The storage 2860 may store a control routine 2840, one or more DAGs 2270, one or more data sets 2370, one or more macros 2470, one or more instance logs 2720, and/or one or more result reports 2770. The control routine 2840 may incorporate a sequence of instructions operative on the processor 2850 of each of the one or more reviewing devices 2800 to implement logic to perform various functions. In embodiments in which multiple ones of the reviewing devices 2800 are operated together as a grid of the reviewing devices 2800, the sequence of instructions of the control routine 2840 may be operative on the processor 2850 of each of those reviewing devices 2800 to perform various functions at least partially in parallel with the processors 2850 of others of the reviewing devices 2800.

[0380] In some embodiments, one or more of the reviewing devices 2800 may be operated by persons and/or entities (e.g., scholastic entities, governmental entities, business entities, etc.) to utilize and/or perform reviews of analysis routines that have been stored in one or more federated areas 2566 as a set of objects, such as a set of task routines 2440 and a job flow definition 2220. In such embodiments, execution of the control routine 2840 may cause the processor 2850 to operate the input device 2810 and/or the display 2880 to provide a user interface by which an operator of the reviewing device 2800 may use the review-

ing device 2800 to view result reports 2770 and/or instance logs 2720 generated by new and/or past performances of job flows. Alternatively, an operator of the reviewing device 2800 may use the reviewing device 2800 to audit aspects of new and/or past performances of job flows, including selections of flow input data sets 2330 used, selections of task routines 2440 used, and/or mid-flow data sets 2370 that were generated and exchanged between task routines 2440, as well as viewing result reports 2770 and/or instance logs 2720. By way of example, the operator of one of the reviewing devices 2800 may be associated with a scholastic, governmental or business entity that seeks to review a performance of a job flow of an analysis that was created by another entity. Such a review may be a peer review between two or more entities involved in scientific or other research, and may be focused on confirming assumptions on which algorithms were based and/or the correctness of the performance of those algorithms. Alternatively, such a review may be part of an inspection by a government agency into the quality of the analyses performed by and relied upon by a business in making decisions and/or assessing its own financial soundness, and may seek to confirm whether correct legally required calculations were used.

[0381] In various embodiments, each of the one or more federated devices 2500 may incorporate one or more of a processor 2550, a storage 2560, one or more neuromorphic devices 2570, and a network interface 2590 to couple each of the one or more federated devices 2500 to the network 2999. The storage 2560 may store control routines 2510 and/or 2540. In some embodiments, part of the storage 2560 may be allocated for at least a portion of one or more federated areas 2566. In other embodiments, each of the one or more federated devices 2500 may incorporate and/or be coupled to one or more storage devices 2600 within which storage space may be allocated for at least a portion of one or more federated areas 2566 in addition to or in lieu of storage space within the storage(s) 2560 being so allocated.

[0382] More precisely, some embodiments of the distributed processing system 2000 may not include the one or more storage devices 2600, at all, and the one or more federated areas 2566 may be defined entirely within the storage(s) 2560 of the one or more federated devices 2500. Other embodiments of the distributed processing system 2000 may include the one or more storage devices 2600 as storage peripherals (e.g., one or more hard drives) and/or network-attached storage (NAS) device(s) that may be coupled to the one or more federated devices 2500, and the one or more federated devices 2500 may operate the one or more storage devices 2600 as additional storage in which the one or more federated areas 2566 may be defined. In still other embodiments, each of the one or more storage devices 2600 may be an independent computing device incorporating its own processor 2650 and storage 2660 coupled to the processor 2650 (depicted in FIGS. 13F-G), and may be capable of serving the function of maintaining the one or more federated areas 2566 (under the control of the one or more federated devices 2500), and/or serving the function of employing its own processing resources to perform job flows in addition to or in lieu of the processing resources of the one or more federated devices 2500 being employed to do so.

[0383] Regardless of where storage space is allocated for one or more federated areas 2566, each of the one or more federated areas 2566 may hold one or more objects such as

one or more job flow definitions **2220**, one or more DAGs **2270**, one or more flow input data sets **2330**, one or more task routines **2440**, one or more macros **2470**, one or more instance logs **2720**, and/or one or more result reports **2770**. In embodiments in which a job flow is performed by the one or more federated devices **2500** (or by the one or more storage devices **2600**) within a federated area **2566**, such a federated area **2566** may at least temporarily hold one or more mid-flow data sets **2370** during times when one or more of the mid-flow data sets **2370** are generated by and exchanged between task routines **2440** during the performance of the job flow. In embodiments in which a DAG **2270** is generated by the one or more federated devices **2500** within a federated area **2566** to provide a visualization of aspects of a job flow, a particular performance of a job flow and/or one or more task routines **2440**, such a federated area **2566** may at least temporarily hold one or more macros **2470** during times when one or more of the macros **2470** are generated as part of generating the DAG **2270**.

[0384] In some embodiments that include the one or more storage devices **2600** in addition to the one or more federated devices **2500**, the maintenance of the one or more federated areas **2566** within such separate and distinct storage devices **2600** may be part of an approach of specialization between the federated devices **2500** and the storage devices **2600**. More specifically, there may be numerous ones of the federated devices **2500** forming the grid **2005** in which each of the federated devices **2500** may incorporate processing and/or other resources selected to better enable the execution of task routines **2440** as part of performing job flows defined by the job flow definitions **2220**, the generation of DAGs **2270**, and/or other processing functions associated with developing, performing and/or analyzing aspects of job flows. Correspondingly, there may be numerous ones of the storage devices **2600** forming the grid **2006** in which the storage devices **2600** may be organized and interconnected in a manner providing a distributed storage system that may provide increased speed of access to objects within each of the one or more federated areas **2566** through parallelism, and/or may provide fault tolerance of storage. Such distributed storage may also be deemed desirable to better accommodate the storage of particularly large ones of the data sets **2330** and/or **2370**, as well as any particularly large data sets that may be incorporated into one or more of the result reports **2770**.

[0385] However, as an alternative to such a division of functions between the devices **2500** and **2600**, or as an augmentation thereto, and even if the one or more federated devices **2500** incorporate considerably more and/or better suited processing resources, it may be deemed desirable for the one or more storage devices **2600** to perform at least a subset of the job flows. As previously explained, it may be that a data object (e.g., a data set **2330** or **2370**, or a result report **2770**) is received by the one or more federated devices **2500** that is of sufficient size that exchanging it among the devices **2500** and **2600** for use as an input to performing a job flow is deemed to be undesirable due to the amount of overhead that would be incurred in doing so (e.g., consumption of time and various resources). In such instances, it may be deemed desirable to utilize the processing resources of the one or more storage devices **2600** to perform such a job flow so that such a large data object may be used as an input thereto without exchanging portions of it (or all of it) among devices. Indeed, the overhead of

moving such a data object to the one or more federated devices **2500** may be significant enough as to outweigh whatever advantages in processing speed and/or efficiency that the processing resources of the one or more federated devices **2500** would provide over using the processing resources of the one or more storage devices **2600**.

[0386] The control routines **2510** and **2540** may each incorporate a sequence of instructions operative on the processor **2550** of each of the one or more federated devices **2500** to implement logic to perform various functions. In embodiments in which multiple ones of the federated devices **2500** are operated together as the grid **2005** of the federated devices **2500**, the sequence of instructions of the control routine **2540** may be operative on the processor **2550** of each of the federated devices **2500** to perform various functions at least partially in parallel with the processors **2550** of others of the federated devices **2500**. As will be described in greater detail, among such functions may be the at least partially parallel performance of job flows defined by one or more of the job flow definitions **2220**, which may include the at least partially parallel execution of one or more of the task routines **2440** to perform tasks specified by the one or more job flow definitions **2220**. As will also be described in greater detail, also among such functions may be the operation of the one or more neuromorphic devices **2570** to instantiate, develop and/or utilize one or more neural networks, or one or more neural network ensembles, to enable neuromorphic processing to be employed in the performance of one or more tasks and/or job flows. Where such functions are performed, one or more data sets **2330** and/or **2370** that include hyperparameters and/or trained parameters of one or more neural networks may be generated, analyzed, modified and/or transferred as a result of the performances of those functions.

[0387] Regarding the control routine **2540**, and as will be discussed repeatedly throughout the present application, the control routine **2540** may be made up of multiple different components **2541** through **2549**. In some embodiments, the control routine **2540** may be generated as a single software routine in which each of these components may be callable subparts (e.g., subroutines, etc.). However, in other embodiments, it may be deemed desirable to allow different portions of the control routine **2540** to be executed by different cores of different processors that may exist within different devices, and/or it may be deemed desirable to allow multiple instances of some portions of the control routine **2540** to be run independently of each other and at least partially in parallel. To accommodate this, it may be that one or more of the components **2541** through **2549** is a separately executable, and perhaps fully self contained, software routine.

[0388] Regarding the control routine **2510**, and as will be discussed in greater detail, the control routine **2510** may be made up of multiple different components executable by one or more processor(s) **2550** to coordinate at least partially parallel performances of various support functions that enable such at least partially parallel performances of tasks and/or job flows. Such support functions may include the monitoring of the status of devices **2500** and/or **2600**, and/or of the resources provided by each. Alternatively or additionally, such support functions may include the instantiation of virtual machines (VMs) **2505** within federated device (s) **2500**.

[0389] Turning to FIG. 13C, as depicted, the control routine **2540** may include a federated area component **2546**

to cause the processor(s) **2550** of the one or more federated devices **2500** to maintain the one or more federated areas **2566** within the storage **2560** of each of the one or more federated devices **2500** and/or within the one or more storage devices **2600**. Many of the operations that the processor(s) **2550** of the one or more federated devices **2500** may be caused to perform by execution of the control routine **2540**, including the instantiation, maintenance and/or un-instantiation of the one or more federated areas **2566**, may be in response to requests received via the network **2999** from the one or more source devices **2100** and/or from the one or more reviewing devices **2800**. Also, many of such received requests may entail the exchange of one or more objects.

[**0390**] As also depicted, the control routine **2540** may also include a portal component **2549** to cause the processor(s) **2550** of the one or more federated devices **2500** to limit access to the one or more federated areas **2566** to particular authorized persons and/or particular authorized devices that may be associated with one or more particular corporate, governmental, scholastic and/or other types of entities. Correspondingly, the processor(s) **2150** of the one or more source devices **2100** may be caused by execution of the control routine **2140** to provide a UI that enables an operator thereof to send such requests to the one or more federated devices **2500**, and/or the processor(s) **2850** of the one or more reviewing devices **2800** may be caused by execution of the control routine **2840** to provide a UI that enables an operator thereof to do so. The processor(s) **2550** of the one or more federated devices **2500** may be caused by the portal component **2549** to cooperate, via the network **2999**, with the requesting device **2100** or **2800** to cause the UI provided thereby to present the operator thereof with a request for a password or other security credential to verify that the operator and/or the requesting device **2100** or **2800** is authorized to make the particular request that has been made.

[**0391**] Alternatively or additionally, some interactions with a requesting device **2100** or **2800**, including requests that may be transmitted via the network **2999** to the one or more federated devices **2566**, may be automated. In embodiments in which such automated requests are made, the requesting device **2100** or **2800** may automatically provide security credentials to the one or more federated devices **2500** to verify that the requesting device **2100** or **2800** is authorized to make the particular request that has been made.

[**0392**] In some embodiments, the requests received by the one or more federated devices **2500** received via the network **2999** and/or the responses transmitted by the one or more federated devices **2500** thereto via the network **2999** may employ formatting, syntax, timing, synchronization with other activities, etc. that conform to one or more industry standards for network communications, programming, processor coordination, etc. By way of example, such aspects of such requests may conform to one or more of the various versions of the specification for the message-passing interface (MPI) promulgated by the MPI Forum, which is a cooperative venture by numerous governmental, corporate and academic entities from around the world. As will be explained in greater detail, one or more objects may be exchanged in such requests and/or in such responses thereto as portions of streamed data that is included therewith.

[**0393**] As further depicted, the control routine **2540** may also include an interpretation component **2547** to cause the processor(s) **2550** of the one or more federated devices **2500** to, in response to any of a variety of error conditions that may arise in performing a requested operation and/or in response to instances in which a request is to be denied, generate a graphical indication of the error and/or the cause for denial. Such a graphical indication may take the form of a DAG **2270** that provides a visual indication of an error or other condition within an object and/or between two or more objects, and may entail interpreting portions of executable instructions, definitions of job flows, specifications of input and/or output interfaces, comments written by programmers, etc., within such objects as job flow definitions **2220**, task routines **2440** and/or instance logs **2720**. Upon being generated, the processor(s) **2550** may be caused by the portal component **2549** to relay such graphical indications (e.g., DAGs **2270**) to the requesting device to be visually presented to an operator thereof and/or stored therein for a future visual presentation to an operator thereof.

[**0394**] Among such requests may be a request to store one or more objects within a federated area **2566**, to access one or more objects stored within a federated area **2566** and/or to delete one or more objects stored within a federated area **2566**. As depicted, the control routine **2540** may include an admission component **2542** to cause the processor(s) **2550** of the one or more federated devices **2500** to apply a set of rules that place constraints on the storage of objects within federated areas and/or the removal of objects therefrom to ensure that job flows are able to be fully performed and/or that past performances of job flows are able to be repeated as part of being scrutinized. In so applying such rules, the processor(s) **2550**, in response to the request, may fully or partially carry out the requested operations, which may result in the exchange of one or more objects via the network **2999** between the requesting device **2100** or **2800** and the one or more federated devices **2500**, depending on the application of such a set of rules. Alternatively, in response, the processor(s) **2550** may transmit an indication of a refusal, via the network **2999** and to the requesting device, to carry out the requested operations, depending on the application of such a set of rules. Such an indication may include a DAG **2270** that visually presents an indication of the reason for the refusal.

[**0395**] Among such requests may be a request for the one or more federated devices **2500** to convert a spreadsheet data structure into a set of objects required for the performance of an analysis as a job flow, and to store those generated objects within a federated area **2566**. Such a spreadsheet data structure may contain one or more two-dimensional arrays of data and multiple formulae for the performance of the analysis. In response, the processor(s) **2550** of the one or more federated devices **2500** may analyze the included data and the formulae to derive a set of task routines and a job flow definition that is able to perform the analysis specified in the data structure in a manner that may be better optimized for a performance of the analysis as a job flow using distributed processing resources of the one or more federated devices **2500**. Additionally, the processor(s) **2550** may generate a DAG **2270** to provide a visual representation of the resulting job flow.

[**0396**] Among such requests may be a request for the processor(s) **2550** of the one or more federated devices **2500** to perform a job flow. It may be that such a request conveys

a job flow identifier and/or an instance log identifier that enables the identification of the job flow requested to be performed, thereby allowing an already generated job flow definition that defines various aspects of the job flow to be retrieved from storage, along with other objects, to enable the requested performance of the job flow. However, it may also be (e.g., where the request conforms to one or more of the MPI specifications) that the request does not provide either a job flow identifier or an instance log identifier, and instead, directly provides portions of the content of a job flow definition, such as flow task identifiers, specifications of interfaces and/or data object identifiers, thereby enabling a job flow definition that defines various aspects of the job flow to be dynamically generated as part of enabling the job flow to be performed.

[0397] Regardless of the exact manner in which a request to perform a job flow is received, the processor(s) 2550 may, in response, retrieve the various objects needed for the performance, including the most up to date versions of the task routines 2440 needed to perform each of the tasks specified in the job flow definition 2220 for the job flow. The processor(s) 2550 may additionally check whether the job flow has already been performed with the same set of most up to date task routines 2440, and if so, may then transmit the result report(s) 2770 of that past performance to the requesting device 2100 or 2800 in lieu of performing what would be a repetition of that past performance. In this way, processing resources may be conserved for use in performing other operations, including other job flows.

[0398] Alternatively, where the request is to repeat a particular past performance of a job flow, the processor(s) 2550 of the one or more federated devices may, in response, use the information included in the request that identifies the job flow to retrieve the various objects associated with the past performance (e.g., the job flow definition 2220, the flow input data set(s) 2330, the task routines 2440) from one or more federated areas 2566, and may then use the retrieved objects to repeat the past performance. In some embodiments, the processor(s) 2550 may also retrieve the results report(s) 2770 generated by the past performance for comparison with the corresponding result report(s) 2770 generated by the repeat performance, and may transmit an indication of the results thereof to the requesting device 2100 or 2800. Such an indication of the results may include a DAG 2270 that may provide a visual indication of any inconsistency identified by the comparison.

[0399] Among such requests may be a request for the one or more federated devices 2500 to generate a DAG 2270 of one or more objects, such as a DAG 2270 of one or more task routines 2440, the task(s) performed by one or more task routines 2440, a job flow specified in a job flow definition 2220, or a past performance of a job flow documented by an instance log 2720. A DAG 2270 may provide visual representations of one or more tasks and/or task routines 2440, including visual representations of inputs and/or outputs of each. In response, the processor(s) 2550 of the one or more federated devices 2500 may generate the requested DAG 2270 and transmit it to the requesting device 2100 or 2800. As an alternative to a request to generate a DAG 2270 using the processing resources of the one or more federated devices 2500, a request may be received for the one or more federated devices 2500 to provide the requesting device 2100 or 2800 a set of objects needed to enable the requesting device 2100 or 2800 to generate a DAG 2270. In

response, the processor(s) 2550 of the one or more federated devices 2500 may generate a set of macros 2470, one for each task or task routine 2440 that is to be included in the DAG 2270 for purposes of being transmitted to the requesting device 2100 or 2800 to enable generation of the DAG 2270 by the requesting device 2100 or 2800.

[0400] Among such requests may be a request to generate a package containing copies of one or more of the federated areas 2566 maintained by the one or more federated devices 2500 to enable the copies of the one or more federated areas 2566 to be instantiated within one or more other devices. The request may specify that each copy of a federated area 2566 that is within the package is to include copies of all of the objects present within the counterpart federated area 2566 from which the copy is generated. Alternatively, the request may specify that each copy of a federated area that is within the package is to include copies of objects present within the counterpart federated area 2566 from which the copy is generated that are needed to perform a specified job flow and/or that are needed to repeat a specified past performance of a job flow. In some embodiments, the processor(s) 2550 of the one or more federated devices 2500 may, in response, apply a set of rules to the generation of the package to ensure that the copies of federated area(s) included therein and/or the copies of sets of objects included within each copy of a federated area 2566 is complete enough to avoid one or more job flows being rendered incapable of being performed as a result of copies of one or more needed objects not having been included in the package. Following generation of the package, the processor(s) 2550 may transmit the package to the requesting device 2100 or 2800.

[0401] Turning to FIG. 13D, as an alternative to the use of separate requests to bring about individual transfers of one or more objects to and from the one or more federated devices 2500, a single request may be made and granted by the processor(s) 2550 of the one or more federated devices 2500 to instantiate a synchronization relationship between a transfer area 2666 instantiated within a specified federated area 2566 maintained by the one or more federated devices 2500, and another transfer area 2166 or 2866 instantiated within the storage 2160 or 2860 of a source device 2100 or a reviewing device 2800, respectively. The transfer area 2666 may occupy the entirety of the federated area 2566 within which it is instantiated, or a designated portion thereof. Correspondingly, the transfer area 2166 or 2866 may occupy a designated portion of the storage 2160 or 2860, respectively. With such a synchronization relationship in place, the contents of the transfer area 2666 may be recurrently synchronized with the contents of the transfer area 2166 or 2866. More specifically, changes made to objects within the transfer area 2666 (e.g., the addition, removal and/or alteration of objects) may trigger the transfer of one or more objects therefrom to the transfer area 2166 or 2866 to cause the contents of these two transfer areas to remain synchronized with each other. Correspondingly, changes made to objects within the transfer area 2166 or 2866 may trigger a similar transfer of one or more objects therefrom to the transfer area 2666 to also cause the contents of these two transfer areas to remain synchronized with each other.

[0402] In some embodiments, processor(s) 2550 of the one or more federated devices 2500 may cooperate with the other device 2100 or 2800 in the triggering of such transfers

by recurrently exchanging indications of the current state of the objects stored in their respective ones of the transfer areas **2666**, and **2166** or **2866**. By way of example, a polling approach may be used in which the one or more federated devices **2500** may be provided with the security credentials required to “log in” to the other device **2100** or **2800** to gain access to the transfers space **2166** or **2866** in a manner similar to that of a user of the other device **2100** or **2800**, and may then compare what objects are present within the transfer space **2166** or **2866**, respectively, to what objects were present during the last time such a check was performed to identify added objects, altered objects and/or removed objects therein. Correspondingly, as an alternative, the other device **2100** or **2800** may be provided with similar credentials to enable the processor(s) **2150** or **2850** thereof to “log in” to the one or more federated devices **2500** to make similar comparisons concerning the objects that are present within the transfer space **2666**. Where a change to an object in one of these transfer areas has been determined to have occurred, the one of these devices that has “logged in” to the other may then make a request of the other to provide the copies of one or more objects that are needed to bring its own one of these transfer areas back into synchronization with the other such that both of these transfer areas again contain the same objects in the same condition.

[0403] In other embodiments, as an alternative to or in addition to such a polling approach, an approach of “volunteering” indications may be used in which the processor (s) **2550** of the one or more federated devices **2500** may, either at a recurring interval of time or in response to the occurrence of changes to one or more objects within the transfer area **2666**, transmit an indication of the current state of objects currently present within the transfer area **2666** to the other device **2100** or **2800**. Where there has been such a change within the transfer area **2666**, such a transmitted indication thereof may be accompanied with the transmission of one or more copies of the objects that are present within the transfer area **2666** to the other device **2100** or **2800** to enable the processor(s) **2150** or **2850** of the other device **2100** or **2800** to bring the transfer area **2166** or **2866**, respectively, back into synchronization with the transfer area **2666** such that both of these transfer areas again contain the same objects in the same condition. Correspondingly, the processor(s) **2150** or **2850** may be use such a “volunteering” approach in similarly transmitting an indication of the current state of the objects currently present within the transfer area **2166** or **2866** to the one or more federated devices **2500**, either at a recurring interval of time or in response to the occurrence of changes to one or more objects within the transfer area **2166** or **2866**, respectively. Similarly, where there has been such a change within the transfer area **2166** or **2866**, such a transmitted indication thereof may be accompanied with the transmission of one or more copies of the objects that are present within the transfer area **2166** or **2866** to the one or more federated devices **2500** to enable the processor(s) **2550** of the one or more federated devices **2500** to bring the transfer area **2666** back into synchronization with the transfer area **2166** or **2866**, respectively, such that both of these transfer areas again contain the same objects in the same condition.

[0404] In some embodiments, the processor(s) **2550** of the one or more federated devices **2500** may be caused by the admission component **2542** to apply the same set of rules restricting the storage of objects within the one or more

federated areas **2566** and/or the removal of objects therefrom as were described above in handling responses to received requests. However, in other embodiments and as will be explained in greater detail, accommodating such a synchronization relationship may entail changes to, or relaxation of, the enforcement of that set of rules. In such other embodiments, instead of applying the set of rules in a manner that disallows the transfer of objects in response to an error condition or other violation of the rules, a DAG **2270** may be generated that provides a visual indication of the rule violation and/or the error condition. Upon being generated, the processor(s) **2550** may be caused by the portal component **2549** to automatically transfer such a DAG **2270** between the two transfer areas as part of the synchronization relationship and to make such a DAG **2270** available in both transfer areas.

[0405] In some embodiments, such a synchronization relationship may be instantiated where the device **2100** or **2800** is at least partially used as a repository for objects, such as a source code repository for an analysis routine that is under development. As will also be explained in greater detail, it may be that developers who are familiar with the use of federated areas **2566** and/or who have been granted access to the one or more federated areas **2566** maintained by the one or more federated devices **2500** may be working in collaboration with other developers who are not so familiar with the use of federated areas **2566** and/or who have not been granted such access. Through such a synchronization relationship, objects developed by such other developers may be contributed to the objects stored within the one or more federated areas **2566** by placing them within the transfer area **2166** or **2866**. Correspondingly, such other developers may be given access to objects stored within the one or more federated areas **2566** by placing those objects (or copies thereof) within the transfer area **2666**.

[0406] As will further be explained in greater detail, such other developers may also not be familiar with a primary programming language that may normally be expected to be used in generating job flow definitions **2220**, DAGs **2270**, task routines **2440** and/or macros **2470**, and as a result, may generate such objects in one or more secondary programming languages. Thus, as part of performing such automated transfers and applying the set of rules, the processor(s) **2550** of the one or more federated devices **2500** may also perform automated translations of at least portions of objects that define or implement input and/or output interfaces. Such translations may be between the primary and secondary programming languages. Alternatively or additionally, such translations may be from the primary and secondary programming languages, and into an intermediate representation, such as an intermediate programming language or a data structure, to enable the earlier described comparisons among definitions and/or implementations of input and/or output interfaces to be made.

[0407] As an alternative to the aforescribed relatively simple synchronization relationship between a single transfer area **2666** within a single federated area **2566** and a single transfer area **2166** or **2866** within a single storage **2160** or **2860**, respectively, in other embodiments, a set of synchronization relationships may be formed that includes multiple transfer areas **2666** across multiple federated areas **2566** and/or that includes multiple transfer areas **2166** or **2866** within a storage **2160** or **2860**, respectively. Such embodiments may be deemed desirable where there is a

collaborative development effort to develop a relatively complex analysis routine between developers familiar with federated areas and/or familiar with the primary programming language normally expected to be used in generating job flow definitions **2220**, DAGs **2270**, task routines **2440** and/or macros **2470**, and developers who may not be familiar with either or both. More specifically, and as will be explained in greater detail, the objects used in the development of such a relatively complex analysis routine may be stored across multiple federated areas **2566** that form a hierarchy thereamong, thereby prompting a need to define a separate transfer area **2666** within each. It may be that a corresponding hierarchy may be created within a storage **2160** or **2860** as a set of directories and/or subdirectories, each with a corresponding transfer area **2166** or **2866**, respectively. Thus, each of the multiple transfer areas **2666** within one of such federated areas **2566** may have a corresponding one of the multiple transfer areas **2166** or **2866** at a corresponding hierarchical position with which it is synchronized.

[0408] Alternatively or additionally, as an alternative to the performance of exchanges of objects occurring in a synchronization relationship being triggered by instances of changes in objects, in other embodiments, exchanges between synchronized transfer areas may also be triggered by an instance of the use of an object to generate a new object. By way of example, and as will be explained in greater detail, where an object, such as a job flow definition **2220** or a DAG **2270**, is used as a component in forming a new object, such as a new job flow definition **2220** or a new DAG **2270**, such a new object may become another of the objects that are kept synchronized in a synchronization relationship between transfer areas. Thus, and more specifically, such a new object, and subsequent changes made thereto, may be copied between a transfer area **2566** and another transfer area **2166** or **2866**. Alternatively, where different programming languages are used, a translated form of such a new object, and of subsequent changes made thereto, may be generated in the other language within the other of the two transfer areas.

[0409] Turning to FIG. 13E, as depicted, the control routine **2510** may include a device allocation component **2519** that is executable by one or more processors **2550** of one or more federated devices **2500** to cause the monitoring and/or allocation of the resources of various devices **2500** and/or **2600** of the distributed processing system **2000**. As also depicted the control routine **2510** may include a VM allocation component **2511** that is executable by one or more processors **2550** of one or more federated devices **2500** to selectively instantiate, monitor and/or control VMs **2505** within one or more federated devices **2500**. In some embodiments, VMs may also be so instantiated, monitored and/or controlled within one or more storage devices **2600**.

[0410] In some embodiments, execution of the device allocation component **2519** by processor(s) **2550** may cause ongoing monitoring of the federated device(s) **2500** of the distributed processing system **2000**. Such monitoring may entail the exchange of indications of status among devices **2500** and/or **2600** via the network **2999**. Such monitoring may include the ongoing and repeated receipt of indications of availability or unavailability (and/or other status details) of each federated device **2500** and/or of each storage device **2600** to detect instances of a device **2500** or **2600** becoming unavailable due to any of a variety of types of failure and/or

due to other events (e.g., being shut down for maintenance and/or repair). Alternatively or additionally, such monitoring may include the ongoing and repeated receipt of indications of levels of availability of various processing, storage and/or other resources provided by each of the devices **2500** and/or **2600** to detect changes in such levels that may serve as triggers for reallocating the manner in which such resources are used to support the execution of various routines and/or of various instances of routines (e.g., instances of the control routine **2540** and/or instances of various components of the control routine **2540**), and/or reallocating the manner in which such resources are used to support the maintenance of federated areas **2566**.

[0411] In some of such embodiments, such reallocations of resources may occur as part of effecting an organized failover between federated devices **2500** and/or between storage devices **2600**. By way of example, received indications of failure of components and/or other features of a federated device **2500**, and/or received indications of a federated device **2500** becoming unavailable as part of being serviced, may trigger the transfer of the performance of operations in support of performing tasks and/or of performing whole job flows from that federated device **2500** to one or more other federated devices **2500**. Also by way of example, received indications of failure of components and/or other features of a storage device **2600**, and/or received indications of a storage device **2600** becoming unavailable as part of being serviced, may trigger the transfer of federated areas **2566** from that storage device **2600** to one or more other storage devices **2600**. In support of effecting such organized failovers, execution of the device allocation component **2519** may cause the maintenance of a federated device **2500** and/or of a storage device **2600** in a “standby” mode to be readily available for use as a “hot spare” with minimal delay.

[0412] In some embodiments, as part of such ongoing and recurring receipt of status information from devices **2500** and/or **2600**, indications of such received status may be stored and repeatedly updated within a device data **2531**. Also stored within the device data **2531** may be indications of predefined minimum requirements for a device **2500** or **2600** to be deemed available, and/or indications of predefined minimum levels of availability of various resources provided by devices **2500** and/or **2600** that are deemed to be minimum requirements to enable the execution of various routines and/or the performance of various functions. It may be that, as a level of availability of a particular resource provided by a device **2500** or **2600** falls below such a predefined minimum level of availability, the execution of one or more particular routines and/or the performance of one or more particular functions may be reallocated to a different device **2500** or **2600**. By way of example, where the level of unused storage space provided by a storage device **2600** is detected as having fallen below a predefined amount of storage space, one or more federated areas **2566** that are maintained therein may be reallocated to available storage space within another storage device **2600**.

[0413] Alternatively or additionally, in some embodiments, execution of the VM allocation component **2511** by processor(s) **2550** may cause ongoing selective instantiation, monitoring and/or control of VMs **2505** within one or more federated devices **2500**. As will be familiar to those skilled in the art, the instantiation of VMs within a computing device may be performed as a mechanism to allocated

controlled amounts of resources of that computing device for use in the execution of various different routines to perform various different functions. By way of example, it may be deemed to be desirable to constrain the levels of resources that are made available to support the performance of particular tasks. Alternatively or additionally, it may be that multiple ones of the VMs 2505 are instantiated within a federated device 2500 as part of providing security between different users (or between different groups of users) by allocating a separate VM 2505 to each user (or group of users). Also alternatively or additionally, there may be different types of VMs 2505 that are each provided with a different set of resources and/or are provided with resources at differing levels in a manner that causes each type of VM 2505 to be at least somewhat specialized for supporting the execution of a different routine or different combination of routines. By way of example, there may be different types of VM 2505 that are each configured to support the execution of different ones of the components of the control routine 2540 therein.

[0414] In some embodiments, the selective instantiation of VMs 2505 across multiple federated devices 2500 may be employed as the mechanism by which the earlier described reallocation of federated devices 2500 and/or of the resources of federated devices 2500 in response to failures, instances of unavailability for servicing, and/or instances of a falling level of availability of a resource below a pre-defined minimum level. Stated differently, the transfer of performances of various operations may be effected by the transfer of VM(s) 2505 between federated devices 2500, and/or the transfer of sufficient state information between VMs 2505 within different federated devices 2500. In some embodiments, execution of the VM allocation component 2511 may cause the ongoing and recurring receipt (e.g., via the network 2999) of indications of status of VMs 2505 from federated devices 2500 in which they are instantiated. As with the statuses of devices 2500 and/or 2600, the statuses of VMs 2505 may be maintained and repeated updated within the device data 2531.

[0415] As an alternative to reallocation of resources through selective instantiation of VMs 2505 (such that performances of various operations may be transferred from a VM 2505 instantiated within one federated device 2500 to another VM 2505 instantiated within another federated device 2500), it may be that the level(s) of various resources allocated to different VMs 2505 within a federated device 2500 may be dynamically altered. In this way, limitations in the levels of resources consumed by each VM 2505 may be enforced onto each VM 2505 to accommodate fluctuations in levels of available resources that are caused by other factors.

[0416] Regardless of the exact manner in which the resources of each device 2500 and/or 2600 may be allocated by components of the control routine 2510, regardless of the exact manner in which VMs 2505 may be allocated, regardless of the exact manner in which resources may be allocated to each VM 2505, and as will be explained in greater detail, indications maintained within the device data 2531 concerning availability of resources, devices 2500 and/or 2600, and/or VMs 2505 may be used as input to still other mechanisms for the allocation of resources to support the parallel performances of tasks and job flows as part of providing MTC. More specifically, and as will be discussed in greater detail, mechanisms for the dynamic instantiation

of container execution environments may employ such information in determining quantities and/or types of containers to be selectively instantiated and/or in determining which device 2500 in which such containers are to be selectively instantiated. Alternatively or additionally, and as will also be explained in greater detail, information associated with such selective instantiation of such containers may be received by components of the control routine 2510 to provide guidance in the selective instantiation of VMs 2505.

[0417] Turning to FIGS. 13F-H, in various embodiments, each of the one or more storage devices 2600 within the depicted set of storage devices 2600a-x and/or 2600z may incorporate a processor 2650 and/or a storage 2660 coupled to the processor. In at least a subset of the storage devices 2600a-x and/or 2600z, the storage 2660 may store a nodal storage routine 2643. Alternatively or additionally, in at least a subset of the storage devices 2600a-x and/or 2600z, the storage 2660 may store a master storage routine 2644. Each of the nodal storage routine 2643 and the master storage routine 2644 may incorporate a sequence of instructions operative on the processor 2650 of each of the storage devices 2600a-x and/or 2600z to implement logic to perform various functions. Each of the storage devices 2600a-x and/or 2600z may be directly coupled to and/or otherwise interact with a single federated device 2560. Alternatively, each of the storage devices 2600a-x and/or 2600z may interact with multiple ones of the federated devices 2560 as a result of being shared thereamong. Although not specifically depicted, such sharing of the storage devices 2600a-x and/or 2600z may be through the network 2999.

[0418] Turning more specifically to FIG. 13F, in some embodiments, at least a subset of the storage devices 2600a-x may be operated by the one or more federated devices 2500 as individual storage devices 2600 where each is caused to store objects (e.g., the depicted objects 2220, 2270, 2330, 2370, 2440, 2470, 2720 and/or 2770) in an undivided manner such that none of such objects are stored in a distributed form that spans multiple ones of the storage devices 2600a-x. As will be explained in greater detail, such storage of objects in an undivided manner may be limited to objects that are of a smaller size than a predetermined threshold size. In such embodiments, and as will also be explained in greater detail, it may be that each federated area 2566 is defined to exist entirely within a single one of the storage devices 2600a-x. Within each such one of the storage devices 2600a-x, the processor 2650 may be caused by its execution of the nodal storage routine 2643 to implement a local file system 2663 within at least a portion of the storage 2660 thereof, and may be caused to cooperate with the one or more federated devices 2560 to define one or more federated areas 2566 within such a portion of the storage 2660 that is occupied by the local file system 2663.

[0419] Turning more specifically to FIG. 13G, in some embodiments, at least a subset of the storage devices 2600a-x and/or 2600z may be operated together by the one or more federated devices 2500 to store at least data objects (e.g., the depicted data objects 2330, 2330d, 2370, 2370d, 2770 and/or 2770d) in a distributed manner such that each of such data objects is divided into data object blocks 2336, 2336d, 2370, 2376d, 2776 and/or 2776d, respectively, which are distributed across multiple ones of such storage devices for storage for storage in a manner that spans multiple ones of the storage devices 2600a-x. As previously discussed, such distributed storage of objects may be limited to those

that are larger in size than the predetermined threshold size. In such embodiments, and as will be explained in greater detail, it may be that each federated area **2566** is defined to span multiple ones of the storage devices **2600a-x**.

[0420] Within the storage device **2600z**, the processor **2650** may be caused by its execution of the master storage routine **2644** to coordinate with such ones of the storage devices **2600a-x** to implement a distributed file system **2664** that spans and encompasses at least a portion of the storage **2660** of each. Within each such one of the storage devices **2600a-x**, the processor **2650** may be caused by its execution of the nodal storage routine **2643** to cooperate with the storage device **2600z** to implement a portion of the distributed file system **2664** within at least a portion of its storage **2660**. The processors **2650** of the storage device **2600z** and of each of such ones of the storage devices **2600a-x** may cooperate with the one or more federated devices **2500** to define one or more federated areas **2566** to span such portions of the storages **2660** within which the distributed file system **2664** is so implemented.

[0421] In some of such embodiments, the distributed file system **2664** that is so implemented may be HDFS, and it may be that the processor **2650** of the storage device **2600z** is caused by the master storage routine **2644** to operate the storage device **2600z** to serve as the “name server” for such an implementation of HDFS. It should be noted that, there may be more than one of the storage device **2600z**, and such additional storage device(s) **2006z** may be maintained as additional name servers to enable the name server functions to be implemented more quickly and/or efficiently through the use of parallelism, and/or to serve as backup name server(s) to provide redundancy against failure in the performance of the name server functions.

[0422] As previously discussed, it may be that a relatively large data object **2330**, **2370** or **2770** received by the one or more federated devices **2500** for storage is of a form that is not able to be divided to directly generate data object blocks in which the data items are organized in a homogeneous manner. Details of the non-homogeneous manner in which items of data may be organized within such a large data object **2330**, **2370** or **2770** may be described in metadata **2338** that may be incorporated into the relatively large data object **2300**, **2370** or **2770**. As also previously discussed, the one or more federated devices **2500** may address this issue by converting such a data object **2330**, **2370** or **2770** from its originally received form and into a distributable form (e.g., as a corresponding one of the data object **2330d**, **2370d** or **2440d**) in which the organization of the data items is changed into a homogeneous manner of organization that enables its division into data object blocks **2336d**, **2376d** or **2446d**, respectively, in which the data items are also organized in a homogeneous manner that makes the data items more readily accessible (e.g., without the need to refer to a distinct metadata structure, such as the depicted metadata **2338**).

[0423] In embodiments in which at least a subset of the storage devices **2600a-x** and/or **2600z** implement HDFS, it may be those storage devices within that subset that perform the division of a data object into blocks for storage. As will be familiar to those skilled in the art, implementing HDFS typically includes selecting a distribution block size that is used to determine whether an object that is to be stored will be divided into blocks, or not. Objects that are larger than the distribution block size will be divided into blocks that are

each no larger than the distribution block size, while objects that are smaller than the threshold size are not so divided. Typical distribution block sizes that have been used in previous implementations of HDFS are 64 MB and 128 MB. The one or more federated devices **2500** may employ the same distribution block size as is used to implement HDFS among the storage devices **2600a-x** and/or **2600z** as the predetermined threshold size used as at least one factor in determining whether or not to convert the form of a data block that is to be stored from the form in which it was originally received and a distributable form.

[0424] In some embodiments, the distribution block size may be associated with storage capacity limitations of one or more of the storage devices **2600**. By way of example, the predetermined threshold size may be selected to trigger the dividing of large data objects that might actually be larger than the storage capacity of any one of the storage devices **2600**. In such embodiments, there may be an upper limit placed on the size of any data object based on the total capacity of a set of storage devices **2600** that are used together to store large data objects in a distributed manner, and such an upper limit may be selected to strike a balance between enabling storage of large data objects, while preventing the storage capacity from being consumed by the storage of a relatively small quantity of data objects. Alternatively, the predetermined threshold size may be selected to cause division of large data objects that are sufficiently large that there is an appreciable improvement possible in speed of access thereto by splitting them up into data object blocks that are distributed across multiple ones of the storage devices **2600**. In each of such other embodiments, there may be an upper limit placed on the size of any data object that may be based on the total storage capacity available in any one of the storage devices **2600**.

[0425] It should be noted that, although the distributed storage of large data objects that are either already in distributable form or that have been converted into distributable form is discussed herein, various circumstances may arise in which other large data objects that are not in distributable form may, nonetheless, also be stored in a distributed manner among multiple ones of the storage devices **2600a-x**. By way of example, it may be that the at least partially parallel performances of a job flow on the earlier stored data object blocks **2336d**, **2376d** or **2776d** of the distributable form of the data object **2330d**, **2370d** or **2770d**, respectively, may result in the generation of corresponding data object blocks of another data set as an output of that job flow. Thus, as a result of such at least partially parallel performances of the job flow, a portion of the storage space provided within each of those storage devices **2600a-x** for a portion of a federated area **2566** may be caused to store a new data object block **2336**, **2376** or **2776** belonging to another data set **2330**, **2370** or **2770**, respectively, that was not generated by dividing a distributable form of a data set **2330d**, **2370d** or **2770d** that is provided by the one or more federated devices such that data items within each may not be organized in a homogeneous manner. Thus, as depicted, a federated area **2566** that spans multiple ones of the storage devices **2600a-x** within the portions of storage space spanned by the distributed file system **2664** may store data object blocks **2336**, **2376** and/or **2776** of data objects **2330**, **2370** or **2770** that are not of distributable form alongside data object blocks **2336d**, **2376d** and/or **2776d** of

data object blocks **2330d**, **2370d** and/or **2770d**, respectively, that are of distributable form.

[0426] As will be explained in greater detail, the selection of which of multiple ones of the storage devices **2600** are used in performing a job flow may be at least partially determined by which of those multiple storage devices **2600** store a data object block of a data object that is to be used as an input in that performance. As will also be explained in greater detail, such generated and stored data object blocks **2336**, **2376** and/or **2776** that are not of distributable form may be selectively combined (e.g., in a reduction operation) to generate a corresponding one of the data object **2330**, **2370** or **2770** of undivided form. By way of example, where a result report **2770** that was originally generated as such data object blocks **2776** during a performance of a job flow is to be transmitted to a device that requested the performance (e.g., a source device **2100** or a reviewing device **2800**), those data object blocks **2776** may be so combined to generate an undivided form of the result report **2770** as part of enabling its transmittal to the requesting device.

[0427] Turning more specifically to FIG. **13H**, although not specifically discussed or depicted in either of FIG. **13F** or **13G**, embodiments of the distributed processing system **2000** are possible in which data objects **2330**, **2370** and/or **2440** may be stored as a mixture of storage as undivided data objects and storage in a distributed manner. Again, the manner in which each data object **2330**, **2370** and **2440** is stored may depend upon its size relative to a predetermined threshold size. More specifically, where a data object **2330**, **2370** or **2440** is of a size that is smaller than the predetermined threshold size, that data object may be stored within a single one of the storage devices **2600** as a single undivided object. However, where a data object **2330**, **2370** or **2440** is or a size that exceeds the predetermined threshold size, that data object may be converted from the form in which it was received and into a distributable form, and may then be stored in a distributed manner among multiple storage devices **2600** as multiple blocks **2336d**, **2376d** and/or **2770d**, respectively.

[0428] As also more specifically depicted in FIG. **13H**, it may be that such storage of data objects **2330**, **2370** and/or **2440** (either as undivided data objects and/or in a distributed manner as data object blocks) is across one or more federated devices **2500**, either in addition to or in lieu of such storage across one or more storage devices **2600**. In such embodiments, it may be the processor(s) **2550** of one or more other federated device(s) **2500** designated as **2500a-x** that execute instructions of the nodal storage routine **2643** to perform operations associated with storing data objects and/or data object blocks, and/or it may be the processor(s) **2550** of one or more federated devices **2500** designated as **2500z** that execute instructions of the master storage routine **2644** to perform operations to coordinate the storage of data objects in at least a distributed manner.

[0429] FIG. **14A** illustrates a block diagram of another example embodiment of a distributed processing system **2000** also incorporating one or more source devices **2100**, one or more reviewing devices **2800**, one or more federated devices **2500** that may form the federated device grid **2005**, and/or one or more storage devices **2600** that may form the storage device grid **2006**. FIG. **14B** illustrates exchanges, through a network **2999**, of communications among the devices **2100**, **2500**, **2600** and/or **2800** associated with the controlled storage of and/or access to various objects within

one or more federated areas **2566**. The example distributed processing system **2000** of FIGS. **14A-B** is substantially similar to the example processing system **2000** of FIGS. **13A-B**, but features an alternate embodiment of the one or more federated devices **2500** providing an embodiment of the one or more federated areas **2566** within which job flows are not performed. Thus, while task routines **2440** may be executed by the one or more federated devices **2500** within each of the one or more federated areas **2566** in addition to storing objects within each of the one or more federated areas **2566** of FIGS. **13A-B**, in FIGS. **14A-B**, each of the one or more federated areas **2566** serves as a location in which objects may be stored, but within which no task routines **2440** are executed.

[0430] Instead, in the example distributed processing system **2000** of FIGS. **14A-B**, the performance of job flows, including the execution of task routines **2440** of job flows, may be performed by the one or more source devices **2100** and/or by the one or more reviewing devices **2800**. Thus, as best depicted in FIG. **14B**, the one or more source devices **2100** may be operated to interact with the one or more federated devices **2500** to more simply store a variety of objects associated with the performance of a job flow within the one or more source devices **2100**. More specifically, one of the source devices **2100** may be operated to store, in a federated area **2566**, a result report **2770** and/or an instance log **2720** associated with a performance of a job flow defined by a job flow definition **2220**, in addition to also being operated to store the job flow definition **2220**, along with the associated task routines **2440** and any associated data sets **2330** in a federated area **2566**. Additionally, such a one of the source devices **2100** may also store any DAGs **2270** and/or macros **2470** that may be associated with those task routines **2440**. As a result, each of the one or more federated areas **2566** is employed to store a record of performances of job flows that occur externally thereof.

[0431] Correspondingly, as part of a review of a performance of a job flow, the one or more reviewing devices **2800** may be operated to retrieve the job flow definition **2220** of the job flow, along with the associated task routines **2440** and any associated data sets **2330** from a federated area **2566**, in addition to retrieving the corresponding result report **2770** generated by the performance and/or the instance log **2720** detailing aspects of the performance. With such a more complete set of the objects associated with the performance retrieved from one or more federated areas **2566**, the one or more reviewing devices **2800** may then be operated to independently repeat the performance earlier carried out by the one or more source devices **2100**. Following such an independent performance, a new result report **2870** generated by the independent performance may then be compared to the retrieved result report **2770** as part of reviewing the outputs of the earlier performance. Where macros **2470** and/or DAGs **2270** associated with the associated task routines **2440** are available, the one or more reviewing devices **2800** may also be operated to retrieve them for use in analyzing any discrepancies revealed by such an independent performance.

[0432] Referring back to all of FIGS. **13A-B** and **14A-B**, the role of generating objects and the role of reviewing the use of those objects in a past performance have been presented and discussed as involving separate and distinct devices, specifically, the source devices **2100** and the reviewing devices **2800**, respectively. However, it should be

noted that other embodiments are possible in which the same one or more devices may be employed in both roles such that at least a subset of the one or more source devices **2100** and the one or more reviewing devices **2800** may be one and the same.

[0433] FIGS. **15A**, **15B**, **15C**, **15D**, **15E**, **15F**, **15G**, **15H**, **15I**, **15J** and **15K**, together, illustrate aspects of the provision of, and interactions among, multiple related federated areas **2566** by the one or more federated devices **2500**. FIG. **15A** depicts aspects of a linear hierarchy of federated areas **2566**, FIG. **15B** depicts aspects of a hierarchical tree of federated areas **2566**, and FIG. **15C** depicts aspects of navigating among federated areas **2566** within the hierarchical tree of FIG. **15B**. FIGS. **15A-C**, together, also illustrate aspects of one or more relationships that may be put in place among federated areas **2566** that may control access to objects stored therein. FIG. **15D** illustrates aspects of selectively allowing users of one or more federated areas **2566** to exercise control over various aspects thereof. FIG. **15E** illustrates aspects of supporting the addition of new federated areas **2566** and/or new users of federated areas **2566**, using an example of building a set of related federated areas **2566** based on the example hierarchical tree of federated areas introduced in FIGS. **15B-C**. FIGS. **15F-H**, together, illustrate aspects of allocating portion(s) of one or more federated areas for one or more specialized functions. FIGS. **15I-K**, together, illustrate various ways in which federated areas **2566** and/or their contents may be defined within storage space(s) provided by one or more storage devices **2600** and/or one or more federated devices **2500**.

[0434] Turning to FIG. **15A**, presented as an example, a set of federated areas **2566q**, **2566u** and **2566x** may be maintained within the storage(s) **2560** of the one or more federated devices **2500** and/or within the one or more storage devices **2600**. As also depicted, a linear hierarchy of degrees of restriction of access may be put in place among the federated areas **2566q**, **2566u** and **2566x**. More specifically, the federated area **2566q** may be a private federated area subject to the greatest degree of restriction in access among the depicted federated areas **2566q**, **2566u** and **2566x**. In contrast, the base federated area **2566x** may be a more “public” federated area to the extent that it may be subject to the least restricted degree of access among the depicted federated areas **2566q**, **2566u** and **2566x**. Further, the intervening federated area **2566u** may be subject to an intermediate degree of restriction in access ranging from almost as restrictive as the greater degree of restriction applied to the private federated area **2566q** to almost as unrestrictive as the lesser degree of restriction applied to the base federated area **2566x**. Stated differently, the number of users granted access may be the largest for the base federated area **2566x**, may progressively decrease to an intermediate number of users for the intervening federated area **2566u**, and may progressively decrease further to a smallest number of users for the private federated area **2566q**.

[0435] There may be any of a variety of scenarios that serve as the basis for selecting the degrees of restriction of access to each of the federated areas **2566q**, **2566u** and **2566x**. By way of example, all three of these federated areas may be under the control of a user of the source device **2100q** where such a user may desire to provide the base federated area **2566x** as a storage location to which a relatively large number of other users may be granted access to make use of objects stored therein by the user of the

source device **2100q** and/or at which other users may store objects as a mechanism to provide objects to the user of the source device **2100q**. Such a user of the source device **2100q** may also desire to provide the intervening federated area **2566u** as a storage location to which a smaller number of selected other users may be granted access, where the user of the source device **2100q** desires to exercise tighter control over the distribution of objects stored therein. Finally, such a user of the source device **2100q** may desire to grant just themselves and/or an even more limited number of selected other users access to the private federated area **2566q** where, perhaps, data objects containing private data, or job flow definitions **2220** and/or task routines **2440** that are not yet deemed ready to distribute more widely may be stored.

[0436] As a result of this hierarchical range of restrictions in access, a user of the depicted source device **2100x** may be granted access to the base federated area **2566x**, but not to either of the other federated areas **2566u** or **2566q**. A user of the depicted source device **2100u** may be granted access to the intervening federated area **2566u**, and as depicted, such a user of the source device **2100u** may also be granted access to the base federated area **2566x**, for which restrictions in access are less than that of the intervening federated area **2566u**. However, such a user of the source device **2100u** may not be granted access to the private federated area **2566q**. In contrast, a user of the source device **2100q** may be granted access to the private federated area **2566q**, and as depicted, may also be granted access to the intervening federated area **2566u** and the base federated area **2566x**, both of which are subject to lesser access restrictions than the private federated area **2566q**.

[0437] As a result of the hierarchy of access restrictions just described, users granted access to the intervening federated area **2566u** are granted access to objects **2220**, **2270**, **2330**, **2370**, **2440**, **2470**, **2720** and/or **2770** that may be stored within either of the intervening federated area **2566u** or the base federated area **2566x**. To enable such users to request the performance of job flows using objects stored in either of these federated areas **2566x** and **2566u**, an inheritance relationship may be put in place between the intervening federated area **2566u** and the base federated area **2566x** in which objects stored within the base federated area **2566x** may be as readily available to be utilized in the performance of a job flow at the request of a user of the intervening federated area **2566u** as objects that are stored within the intervening federated area **2566u**.

[0438] Similarly, also as a result of the hierarchy of access restrictions just described, the one or more users granted access to the private federated area **2566q** are granted access to objects **2220**, **2270**, **2330**, **2370**, **2440**, **2470**, **2720** and/or **2770** that may be stored within any of the private federated area **2566q**, the intervening federated area **2566u** or the base federated area **2566x**. Correspondingly, to enable such users to request the performance of job flows using objects stored in any of these federated areas **2566x** and **2566u**, an inheritance relationship may be put in place among the private federated area **2566q**, the intervening federated area **2566u** and the base federated area **2566x** in which objects stored within the base federated area **2566x** or the intervening federated area **2566u** may be as readily available to be utilized in the performance of a job flow at the request of a user of the private federated area **2566q** as objects that are stored within the private federated area **2566q**.

[0439] Such inheritance relationships among the federated areas 2566q, 2566u and 2566x may be deemed desirable to encourage efficiency in the storage of objects throughout by eliminating the need to store multiple copies of the same objects throughout multiple federated areas 2566 to make them accessible throughout a hierarchy thereof. More precisely, a task routine 2440 stored within the base federated area 2566x need not be copied into the private federated area 2566q to become available for use during the performance of a job flow requested by a user of the private federated area 2566q and defined by a job flow definition 2220 that may be stored within the private federated area 2566q.

[0440] In some embodiments, such inheritance relationships may be accompanied by corresponding priority relationships to provide at least a default resolution to instances in which multiple versions of an object are stored in different ones of the federated areas 2566q, 2566u and 2566x such that one version thereof must be selected from among multiple federated areas for use in the performance of a job flow. By way of example, and as will be explained in greater detail, there may be multiple versions of a task routine 2440 that may be stored within a single federated area 2566 or across multiple federated areas 2566. This situation may arise as a result of improvements being made to such a task routine 2440, and/or for any of a variety of other reasons. Where a priority relationship is in place between at least the base federated area 2566x and the intervening federated area 2566u, in addition to an inheritance relationship therebetween, and where there is a different version of a task routine 2440 within each of the federated areas 2566u and 2566x that may be used in the performance of a job flow requested by a user of the intervening federated area 2566u (e.g., through the source device 2100u), priority may be automatically given by the processor(s) 2550 of the one or more federated devices 2500 to using a version stored within the intervening federated area 2566u over using any version that may be stored within the base federated area 2566x. Stated differently, the processor(s) 2550 of the one or more federated devices 2500 may be caused to search within the intervening federated area 2566u, first, for a version of such a task routine 2440, and may use a version found therein if a version is found therein. The processor(s) 2550 of the one or more federated devices 2500 may then entirely forego searching within the base federated area 2566x for a version of such a task routine 2440, unless no version of the task routine 2440 is found within the intervening federated area 2566u.

[0441] Similarly, where a priority relationship is in place among all three of the federated areas 2566x, 2566u and 2566q, in addition to an inheritance relationship thereamong, and where there is a different version of a task routine 2440 within each of the federated areas 2566q, 2566u and 2566x that may be used in the performance of task of a job flow requested by a user of the private federated area 2566q (e.g., through the source device 2100q), priority may be automatically given to using the version stored within the private federated area 2566q over using any version that may be stored within either the intervening federated area 2566u or the base federated area 2566x. However, if no version of such a task routine 2440 is found within the private federated area 2566q, then the processor(s) 2550 of the one or more federated devices 2500 may be caused to search next within the intervening federated area 2566u for a version of such a task routine 2440, and may use a version

found therein if a version is found therein. However, if no version of such a task routine 2440 is found within either the private federated area 2566q or the intervening federated area 2566u, then the processor(s) 2550 of the one or more federated devices 2500 may be caused to search within the base federated area 2566x for a version of such a task routine 2440, and may use a version found therein if a version is found therein.

[0442] In some embodiments, inheritance relationships may be accompanied by corresponding dependency relationships that may be put in place to ensure that all objects required to perform a job flow continue to be available. As will be explained in greater detail, for such purposes as enabling accountability and/or investigating errors in analyses, it may be deemed desirable to impose restrictions against actions that may be taken to delete (or otherwise make inaccessible) objects stored within a federated area 2566 that are needed to perform a job flow that is defined by a job flow definition 2220 within that same federated area 2566. Correspondingly, where an inheritance relationship is put in place among multiple federated areas 2566, it may be deemed desirable to put a corresponding dependency relationship in place in which similar restrictions are imposed against deleting (or otherwise making inaccessible) an object in one federated area 2566 that may be needed for the performance of a job flow defined by a job flow definition 2220 stored within another federated area 2566 that is related by way of an inheritance relationship put in place between the two federated areas 2566. More specifically, where a job flow definition 2220 is stored within the intervening federated area 2566u that defines a job flow that requires a task routine 2440 stored within the base federated area 2566x (which is made accessible from within the intervening federated area 2566u as a result of an inheritance relationship with the base federated area 2566x), the processor(s) 2550 of the one or more federated devices 2500 may not permit the task routine 2440 stored within the base federated area 2566x to be deleted. However, in some embodiments, such a restriction against deleting the task routine 2440 stored within the base federated area 2566x may cease to be imposed if the job flow definition 2220 that defines the job flow that requires that task routine 2440 is deleted, and there are no other job flow definitions 2220 stored elsewhere that also have such a dependency on that task routine 2440.

[0443] Similarly, where a job flow definition 2220 is stored within the private federated area 2566q that defines a job flow that requires a task routine 2440 stored within either the intervening federated area 2566u or the base federated area 2566x (with which there may be an inheritance relationship), the processor(s) of the one or more federated devices 2500 may not permit that task routine 2440 to be deleted. However, such a restriction against deleting that task routine 2440 may cease to be imposed if the job flow definition 2220 that defines the job flow that requires that task routine 2440 is deleted, and there are no other job flow definitions 2220 stored elsewhere that also have such a dependency on that task routine 2440.

[0444] In concert with the imposition of inheritance and/or priority relationships among a set of federated areas 2566, the exact subset of federated areas 2566 to which a user is granted access may be used as a basis to automatically select a “perspective” from which job flows may be performed by the one or more federated devices 2500 at the request of that

user. Stated differently, where a user requests the performance of a job flow, the retrieval of objects required for that performance may be based, at least by default, on what objects are available at the federated area **2566** among the one or more federated areas **2566** to which the user is granted access that has highest degree of access restriction. The determination of what objects are so available may take into account any inheritance and/or priority relationships that may be in place that include such a federated area **2566**. Thus, where a user granted access to the private federated area **2566q** requests the performance of a job flow, the processor(s) **2550** of the federated devices **2500** may be caused to select the private federated area **2566q** as the perspective on which determinations concerning which objects are available for use in that performance will be based, since the federated area **2566q** is the federated area **2566** with the most restricted access that the user has been granted access to within the depicted linear hierarchy of federated areas **2566**. With the private federated area **2566q** so selected as the perspective, any inheritance and/or priority relationships that may be in place between the private federated area **2566q** and either of the intervening federated area **2566u** or the base federated area **2566x** may be taken into account in determining whether any objects stored within either are to be deemed available for use in that performance (which may be a necessity if there are any objects that are needed for that performance that are not stored within the private federated area **2566q**).

[0445] Alternatively or additionally, in some embodiments, such an automatic selection of perspective may be used to select the storage space in which a performance takes place and/or in which objects associated with that performance may be stored. Stated differently, as part of maintaining the security that is intended to be provided through the imposition of a hierarchy of degrees of access restriction across multiple federated areas **2566**, a performance of a job flow requested by a user may, at least by default, be performed within the federated area that has the highest degree of access restriction among the one or more federated areas to which that user has been granted access. Thus, where a user granted access to the private federated area **2566q** requests a performance of a job flow by the one or more federated devices **2500**, such a requested performance of that job flow may automatically be so performed by the processor(s) **2550** of the one or more federated devices **2500** within the storage space of the private federated area **2566q**. In this way, aspects of such a performance are kept out of reach from other users that have not been granted access to the private federated area **2566q**, including any objects that may be generated as a result of such a performance (e.g., mid-flow data sets **2370**, result reports **2770**, instance logs **2720**, etc.). Such a default selection of a federated area **2566** having more restricted access in which to perform a job flow may be based on a presumption that each user will prefer to have the job flow performances that they request being performed within the most secure federated area **2566** to which they have been granted access.

[0446] It should be noted that, although a relatively simple example linear hierarchy of just three federated areas is depicted in FIG. 15A for sake of simplicity of depiction and discussion, other embodiments of a linear hierarchy are possible in which there may be multiple intervening federated areas **2566** of progressively changing degree of restriction in access between the base federated area **2566x** and the

private federated area **2566q**. Therefore, this depicted example quantity of just three federated areas should not be taken as limiting.

[0447] It should also be noted that, although just a single source device **2100** is depicted as having been granted access to each of the depicted federated areas **2566**, this has also been done for sake of simplicity of depiction and discussion, and other embodiments are possible in which access to one or more of the depicted federated areas **2566** may be granted to users of more than one device. More specifically, the manner in which restrictions in access to a federated area **2566** may be implemented may be in any of a variety of ways, including and not limited to, restricting access to one or more particular users (e.g., through use of passwords or other security credentials that are associated with particular persons and/or with particular organizations of people), and/or restricting access to one or more particular devices (e.g., through certificates or security credentials that are stored within one or more particular devices that may be designated for use in gaining access).

[0448] Turning to FIG. 15B, a larger set of federated areas **2566m**, **2566q**, **2566r**, **2566u** and **2566x** may be maintained within the storage(s) **2560** of the one or more federated devices **2500** and/or within the one or more storage devices **2600**. As depicted, a tree-like hierarchy of degrees of restriction of access, similar to the hierarchy depicted in FIG. 15A, may be put in place among the federated areas **2566** within each of multiple branches and/or sub-branches of the depicted hierarchical tree. More specifically, each of the federated areas **2566m**, **2566q** and **2566r** may be a private federated area subject to the highest degrees of restriction in access among the depicted federated areas **2566m**, **2566q**, **2566r**, **2566u** and **2566x**. Again, in contrast, the base federated area **2566x** may be a more public federated area to the extent that it may be subject to the least restricted degree of access among the depicted federated areas **2566m**, **2566q**, **2566r**, **2566u** and **2566x**. Further, the intervening federated area **2566u** interposed between the base federated area **2566x** and each of the private federated areas **2566q** and **2566r** may be subject to an intermediate degree of restriction in access ranging from almost as restrictive as the degree of restriction applied to either of the private federated areas **2566q** or **2566r** to almost as unrestrictive as the degree of restriction applied to the base federated area **2566x**. Thus, as in the case of the linear hierarchy depicted in FIG. 15A, the number of users granted access may be the largest for the base federated area **2566x**, may progressively decrease to an intermediate number for the intervening federated area **2566u**, and may progressively decrease further to smaller numbers for each of the private federated areas **2566m**, **2566q** and **2566r**. Indeed, the hierarchical tree of federated areas **2566** of FIG. 15B shares many of the characteristics concerning restrictions of access of the linear hierarchy of federated areas **2566** of FIG. 15A, such that the linear hierarchy of FIG. 15A may be aptly described as a hierarchical tree without branches.

[0449] As a result of the depicted hierarchical range of restrictions in access, a user of the depicted source device **2100x** may be granted access to the base federated area **2566x**, but not to any of the other federated areas **2566m**, **2566q**, **2566r** or **2566u**. A user of the depicted source device **2100u** may be granted access to the intervening federated area **2566u**, and may also be granted access to the base federated area **2566x**, for which restrictions in access are less

than that of the intervening federated area **2566u**. However, such a user of the source device **2100u** may not be granted access to any of the private federated areas **2566m**, **2566q** or **2566r**. In contrast, a user of the source device **2100q** may be granted access to the private federated area **2566q**, and may also be granted access to the intervening federated area **2566u** and the base federated area **2566x**, both of which are subject to lesser restrictions in access than the private federated area **2566q**. A user of the source device **2100r** may similarly be granted access to the private federated area **2566r**, and may similarly also be granted access to the intervening federated area **2566u** and the base federated area **2566x**. Additionally, a user of the source device **2100m** may be granted access to the private federated area **2566m**, and may also be granted access to the base federated area **2566x**. However, none of the users of the source devices **2100m**, **2100q** and **2100r** may be granted access to the others of the private federated areas **2566m**, **2566q** and **2566r**.

[0450] As in the case of the linear hierarchy of FIG. 15A, within the depicted branch **2561xm**, one or more of inheritance, priority and/or dependency relationships may be put in place to enable objects stored within the base federated area **2566x** to be accessible from the private federated area **2566m** to the same degree as objects stored within the private federated area **2566m**. Similarly, within the depicted branch **2561xqr**, and within each of the depicted sub-branches **2561uq** and **2561ur**, one or more of inheritance, priority and/or dependency relationships may be put in place to enable objects stored within either of the intervening federated area **2566u** and the base federated area **2566x** to be accessible from the private federated areas **2566q** and **2566r** to the same degree as objects stored within the private federated areas **2566q** and **2566r**, respectively.

[0451] Turning to FIG. 15C, the same hierarchical tree of federated areas **2566m**, **2566q**, **2566r**, **2566u** and **2566x** of FIG. 15B is again depicted to illustrate an example of the use of human-readable forms of identification to enable a person to distinguish among multiple federated areas **2566**, and to navigate about the hierarchical tree toward a desired one of the depicted federated areas **2566m**, **2566q**, **2566r**, **2566u** or **2566x**. More specifically, each of the federated areas **2566m**, **2566q**, **2566r**, **2566u** and **2566x** may be assigned a human-readable textual name such as the depicted textual names “mary”, “queen”, “roger”, “uncle” and “x-ray”, respectively. In some embodiments, each of these human-readable names may be stored and maintained as a human-readable federated area identifier **2568**, where the human-readable text of each such human-readable FA identifier **2568** may have any of a variety of meanings to the persons who assign and use them, including and not limited to, indications of who each of these federated areas **2566** belongs to, what the purpose of each of these federated areas **2566** is deemed to be, how each of these federated areas **2566** relates to the others functionally and/or in terms of location within the depicted tree, etc.

[0452] In this depicted example, these depicted human-readable FA identifiers **2568** have been created to also serve as part of a system of navigation in which a web browser of a remote device (e.g., one of the devices **2100** or **2800**) may be used with standard web access techniques through the network **2999** to navigate about the depicted tree. More specifically, each of these human-readable FA identifiers **2568** may form at least part of a corresponding URL that may be structured to provide an indication of where its

corresponding one of these federated areas **2566** is located within the hierarchical tree. By way of example, the URL of the base federated area **2566x**, which is located at the root of the tree, may include the name “x-ray” of the base federated area **2566x**, but not include any of the names assigned to any other of these federated areas. In contrast, each of the URLs of each of the private federated areas located at the leaves of the hierarchical tree may be formed, at least partially, as a concatenation of the names of the federated areas that are along the path from each such private federated area at a leaf location of the tree to the base federated area **2566x** at the root of the tree. By way of example, the private federated area **2566r** may be assigned a URL that includes the names of the private federated area **2566r**, the intervening federated area **2566u** and the base federated area **2566x**, thereby providing an indication of the entire path from the leaf position of the private federated area **2566r** within the tree to the root position of the base federated area **2566x**.

[0453] In some embodiments, either in lieu of the assignment of human-readable FA identifiers **2568**, or in addition to the assignment of human-readable FA identifiers **2568**, each federated area **2566** may alternatively or additionally be assigned a global federated area identifier **2569** (GUID) that is intended to be unique across all federated areas **2566** that may be instantiated around the world. In some of such embodiments, such uniqueness may be made at least highly likely by generating each such global FA identifier **2569** as a random number or other form of randomly generated set of bits with a relatively large bit width such that the possibility of two federated areas **2566** ever being assigned the same global FA identifier **2569** is deemed sufficiently small that each global FA identifier **2569** is deemed, for all practical purposes, to be unique across the entire world. Such practically unique global FA identifiers **2569** may be so generated and assigned to each federated area **2566** in addition to the human-readable FA identifiers **2568** to provide a mechanism by which each federated area **2566** will always remain uniquely distinguishable from all others, regardless of any situation that may arise where two or more federated areas **2566** are somehow given identical human-readable FA identifiers **2568**.

[0454] It should be noted that, unlike the human-readable FA identifiers **2568** that may be manually entered and assigned by an operator of another device (e.g., one of the devices **2100** or **2800**) that may be in communication with the one or more federated devices **2500** via the network **2999**, the global FA identifiers **2569** may be automatically generated by the one or more federated devices **2500** as part of the instantiation of any new federated area **2566**. Such automatic generation of the global FA identifiers **2569** as part of instantiating any new federated area **2566** may be deemed desirable to ensure that such practically unique identification functionality is provided for each federated area **2566** from the very moment that it exists. This may also be deemed desirable to provide some degree of continuity in the unique identification of each federated area **2566** throughout the time it exists, since in some embodiments, the human-readable FA identifiers **2568** may be permitted to be changed throughout the time it exists.

[0455] Turning to FIG. 15D, the control routine **2540** executed by processor(s) **2550** of the one or more federated devices **2500** may include a federated area component **2546** to control the instantiation of, maintenance of, relationships among, and/or un-instantiation of federated areas **2566**

within the storage **2560** of one or more federated devices **2500** and/or within one or more of the storage devices **2600**. The control routine **2540** may also include a portal component **2549** to restrict access to the one or more federated areas **2566** to only authorized users (e.g., authorized persons, entities and/or devices), and may restrict the types of accesses made to only the federated area(s) **2566** for which each user and/or each device is authorized. However, in alternate embodiments, control of access to the one or more federated areas **2566** may be provided by one or more other devices that may be interposed between the one or more federated devices **2500** and the network **2999**, or that may be interposed between the one or more federated devices **2500** and the one or more storage devices **2600** (if present), or that may still otherwise cooperate with the one or more federated devices **2500** to do so.

[0456] In executing the portal component **2549**, the processor(s) **2550** of the one or more federated devices **2500** may be caused to operate one or more of the network interfaces **2590** to provide a portal accessible by other devices via the network **2999** (e.g., the source devices **2100** and/or the reviewing devices **2800**), and through which access may be granted to the one or more federated areas **2566**. In some embodiments in which the one or more federated devices **2500** additionally serve to control access to the one or more federated areas **2566**, the portal may be implemented employing the hypertext transfer protocol over secure sockets layer (HTTPS) to provide a website securely accessible from other devices via the network **2999**. Such a website may include a webpage generated by the processor **2550** that requires the provision of a password and/or other security credentials to gain access to the one or more federated areas **2566**. Such a website may be configured for interaction with other devices via an implementation of representational state transfer (REST or RESTful) application programming interface (API). However, other embodiments are possible in which the processor **2550** may provide a portal accessible via the network **2999** that is implemented in any of a variety of other ways using any of a variety of handshake mechanisms and/or protocols to selectively provide secure access to the one or more federated areas **2566**.

[0457] Regardless of the exact manner in which a portal may be implemented and/or what protocol(s) may be used, in determining whether to grant or deny access to the one or more federated areas **2566** to another device from which a request for access has been received, the processor(s) **2550** of the one or more federated devices **2500** may be caused to refer to indications stored within portal data **2539** of users authorized to be granted access. Such indications may include indications of security credentials expected to be provided by such persons, entities and/or machines. In some embodiments, such indications within the portal data **2539** may be organized into a database of accounts that are each associated with an entity with which particular persons and/or devices may be associated. The processor(s) **2550** may be caused to employ the portal data **2539** to evaluate security credentials received in association with a request for access to the at least one of the one or more federated areas **2566**, and may operate a network interface **2590** of one of the one or more federated devices **2500** to transmit an indication of grant or denial of access to the at least one requested federated area **2566** depending on whether the processor(s) **2550** determine that access is to be granted.

[0458] Beyond selective granting of access to the one or more federated areas **2566** (in embodiments in which the one or more federated devices **2500** control access thereto), the processor(s) **2550** may be further caused by execution of the portal component **2549** to restrict the types of access granted, depending on the identity of the user to which access has been granted. By way of example, the portal data **2539** may indicate that different users are each to be allowed to have different degrees of control over different aspects of one or more federated areas **2566**. A user may be granted a relatively high degree of control such that they are able to create and/or remove one or more federated areas **2566**, are able to specify which federated areas **2566** may be included in a set of federated areas, and/or are able to specify aspects of relationships among one or more federated areas **2566** within a set of federated areas. Alternatively or additionally, a user may be granted a somewhat more limited degree of control such that they are able to alter the access restrictions applied to one or more federated areas **2566** such that they may be able to control which users have access each of such one or more federated areas **2566**.

[0459] The processor(s) **2550** may be caused by execution of the portal component **2549** to store indications of such changes concerning which users have access to which federated areas **2566** and/or the restrictions applied to such access as part of the portal data **2539**, where such indications may take the form of sets of correlations of authorized users to federated areas **2566** and/or correlations of federated areas **2566** to authorized users. In such indications of such correlations, either or both of the human-readable FA identifiers **2568** or the global FA identifiers **2569** may be used. Where requests to add, remove and/or alter one or more federated areas **2566** are determined, through execution of the portal component **2549** to be authorized, the processor(s) **2550** may be caused by execution of the federated area component **2546** to carry out such requests.

[0460] FIG. 15E depicts an example of a series of actions that the processor(s) **2550** are caused to take in response to the receipt of a series of requests to add federated areas **2566** that eventually results in the creation of the tree of federated areas **2566** depicted in FIGS. 15B-C. As depicted, the processor(s) **2550** of the one or more federated devices **2500** may initially be caused to instantiate and maintain both the private federated area **2566m** and the base federated area **2566x** as part of a set of related federated areas that form a linear hierarchy of degrees of access restriction therebetween. In some embodiments, the depicted pair of federated areas **2566m** and **2566x** may have been caused to be generated by a user of the source device **2100m** having sufficient access permissions (as determined via the portal component **2549**) as to be able to create the private federated area **2566m** for private storage of one or more objects that are meant to be accessible by a relatively small number of users, and to create the related public federated area **2566x** for storage of objects meant to be made more widely available through the granting of access to the base federated area **2566x** to a larger number of users. Such access permissions may also include the granted ability to specify what relationships may be put in place between the federated areas **2566m** and **2566x**, including and not limited to, any inheritance, priority and/or dependency relationships therebetween. Such characteristics about each of the federated areas **2566m** and **2566x** may be caused to be stored by the federated area component **2546** as part of the federated area

parameters **2536**. As depicted, the federated area parameters **2536** may include a database of information concerning each federated area **2566** that is caused to be instantiated and/or maintained by the federated area component **2546**. As with the database of accounts just earlier described as being implemented in some embodiments within the portal data **2539**, such a database of information concerning federated areas **2566** within the federated area parameters **2536** may also make use of either or both of the human-readable FA identifiers **2568** or the global FA identifiers **2569** to identify each federated area **2566**.

[**0461**] As an alternative to both of the federated areas **2566m** and **2566x** having been created and caused to be related to each other through express requests by a user, in other embodiments, the processor(s) **2550** of the one or more federated devices **2500** may be caused by the federated area component **2546**, and based on rules retrieved from federated area parameters **2536**, to automatically create and configure the private federated area **2566m** in response to a request to add a user associated with the source device **2100m** to the users permitted to access the base federated area **2566x**. More specifically, a user of the depicted source device **2100x** that may have access permissions to control various aspects of the base federated area **2566x** may operate the source device **2100x** to transmit a request to the one or more federated devices **2500**, via the portal provided thereby on the network **2999**, to grant a user associated with the source device **2100m** access to use the base federated area **2566x**. In response, and in addition to so granting the user of the source device **2100m** access to the base federated area **2566x**, the processor(s) **2550** of the one or more federated devices **2500** may automatically generate the private federated area **2566m** for private use by the user of the source device **2100m**. Such automatic operations may be triggered by an indication stored in the federated area database within the federated area parameters **2536** that each user that is newly granted access to the base federated area **2566x** is to be so provided with their own private federated area **2566**. This may be deemed desirable as an approach to making the base federated area **2566x** easier to use for each such user by providing individual private federate areas **2566** within which objects may be privately stored and/or developed in preparation for subsequent release into the base federated area **2566x**. Such users may be able to store private sets of various tools that each may use in such development efforts.

[**0462**] Following the creation of both the federated areas **2566x** and **2566m**, the processor(s) **2550** of the one or more federated devices **2500** may be caused to instantiate and maintain the private federated area **2566q** to be part of the set of federated areas **2566m** and **2566x**. In so doing, the private federated area **2566q** is added to the set in a manner that converts what was a linear hierarchy into a hierarchical tree with a pair of branches. As with the instantiation of the private federated area **2566m**, the instantiation of the private federated area **2566q** may also be performed by the processor(s) **2550** of the one or more federated devices **2500** as an automated response to the addition of a user of the depicted source device **2100q** as authorized to access the base federated area **2566x**. Alternatively, a user with access permissions to control aspects of the base federated area **2566x** may operate the source device **2100x** to transmit a request to the portal generated by the one or more federated devices **2500** to create the private federated area **2566q**, with inheritance, priority and/or dependency relationships with the base fed-

erated area **2566x**, and with access that may be limited (at least initially) to the user of the source device **2100q**.

[**0463**] Following the addition of the federated area **2566q**, the processor(s) **2550** of the one or more federated devices **2500** may be caused to first, instantiate the intervening federated area **2566u** inserted between the private federated area **2566q** and the base federated area **2566x**, and then instantiate the private federated area **2566r** that branches from the newly created intervening federated area **2566u**. In so doing, the second branch that was created with the addition of the private federated area **2566q** is expanded into a larger branch that includes both of the private federated areas **2566q** and **2566r** in separate sub-branches.

[**0464**] In various embodiments, the insertion of the intervening federated area **2566u** may be initiated in a request transmitted to the portal from either the user of the source device **2100q** or the user of the source device **2100x**, depending on which user has sufficient access permissions to be permitted to make such a change in the relationship between the private federated area **2566q** and the base federated area **2566x**, including the instantiation and insertion of the intervening federated area **2566u** therebetween. In some embodiments, it may be necessary for such a request made by one of such users to be approved by the other before the processor(s) **2550** of the one or more federated devices **2500** may proceed to act upon it.

[**0465**] Such a series of additions to a hierarchical tree may be prompted by any of a variety of circumstances, including and not limited to, a desire to create an isolated group of private federated areas that are all within a single isolated branch that includes an intervening federated area by which users associated with each of the private federated areas within such a group may be able to share objects without those objects being more widely shared outside the group as by being stored within the base federated area **2566x**. Such a group of users may include a group of collaborating developers of task routines **2440**, data sets **2330** and/or job flow definitions **2220**.

[**0466**] As each of the federated areas **2566m**, **2566q**, **2566r**, **2566u** and **2566x** are created, each may be given a human-readable FA identifier **2568** that may be supplied in the requests that are received to create each of them and/or that may be supplied and/or generated in any of a variety of other ways, including through any of a variety of user interfaces. Also, as previously discussed, regardless of the manner or circumstances in which each of the depicted federated areas **2566m**, **2566q**, **2566r**, **2566u** or **2566x** is instantiated, in at least some embodiments, the processor(s) **2550** may be caused to generate a global FA identifier **2569** for each of these federated areas automatically as part of each of their instantiations. Again, this may be deemed desirable in order to have each of these federated areas be immediately distinguishable by such a practically unique identifier from the moment that each begins its existence. In this way, such global FA identifiers **2569** may be immediately available to be used to identify each of these federated areas within both the federated area parameters **2536** and the portal data **2539**.

[**0467**] FIG. 15F depicts various examples of designating at least a portion of a federated area **2566** as a storage location that serves a specialized purpose. As depicted, the processor(s) **2550** of the one or more federated devices **2500** may be caused to instantiate different ones of these depicted examples of a portion of a federated area **2566** by the

execution of the executable instructions of different components of the control routine **2540**, and/or by the execution of a resource allocation routine **2411**. As also depicted, such designated portions of a federated area **2566** may also be caused to co-exist with another portion of the federated area **2566** that may not be so designated, and which may be used simply for the storage of objects **2220**, **2270**, **2330**, **2370**, **2440**, **2470**, **2720** and/or **2770**, and/or used for the storage of data object blocks **2336**, **2336d**, **2376**, **2376d**, **2776** and/or **2776d** that each form a portion of a data object **2330**, **2330d**, **2370**, **2370d**, **2770** and/or **2770d**, respectively.

[0468] As has already been discussed, the processor(s) **2550** of the one or more federated devices **2500** may be caused by execution of the federated area component **2546** to instantiate a transfer area **2666** within a federated area **2566** as part of providing a mechanism by which the processor(s) **2550** may be caused by execution of one or more of the admission component **2542**, the selection component **2543** and/or the database component **2545** to exchange objects between the one or more federated devices **2500** and other devices. Again, such transfers may be triggered as part of synchronizing the contents of the transfer area **2666** with the contents of a corresponding transfer area within another device (e.g., the transfer area **2166** or **2866** instantiated within another device **2100** or **2800**, respectively, depicted in FIG. 13D). Again, by way of example, where such transfer areas **2666** may be instantiated to implement synchronization of objects where another device that does not implement federated areas **2566** is, nonetheless, used as a source code repository (e.g., a device functioning as a GitHub™ source code server) in a situation where cooperation in source code development is underway between developers.

[0469] As will be discussed in greater detail, the processor (s) **2550** of the federated device(s) **2500** may be caused to instantiate shared memory space(s) **2665** to improve various aspects of storing, retrieving and/or exchanging data objects that are in a form associated with a secondary programming language that is not the primary programming language that is deemed to be the default programming language in which task routines **2440** are to be written. As will be familiar to those skilled in the art, different programming languages may support differing data types, and/or differing approaches to accessing, organizing and/or indexing data items within arrays and/or other complex data types. Further, even where two programming languages at least nominally support a common data type, there may well be differences in structural details therebetween.

[0470] By way of example, although two programming languages may both support the use of some form of two-dimensional (2D) array, it may be that they support different varieties of data types for the individual data values within a 2D array, different indexing schemes (e.g., 16-bit indexes vs. 32-bit indexes, or 0-based indexing vs. 1-based indexing), different byte encodings (e.g., little Endian vs. big Endian), different organizations of elements (e.g., row-column vs. column-row, highest-numbered row first vs. lowest-numbered row first, or structured vs. unstructured), different separators (e.g., commas vs. empty spaces to separate data items or rows of data items), different organizations of row and/or column headings, different text encodings (e.g., ASCII vs. EBCDIC vs. double-byte character set encoding), etc. As a result, relatively minor differences in the definitions of such structures as 2D arrays between two

programming languages may prevent a 2D array generated with executable instructions in one programming language from being read, as is, by executable instructions in another programming language. This may cause data objects **2330**, **2370** and/or **2770** that are output by one task routine **2440** with executable instructions **2447** written in one programming language to be unusable as input to another task routine **2440** with executable instructions **2447** written in another programming language without some degree of conversion being performed to cause such data objects to be changed from one form associated with the one programming language to another form associated with the other programming language.

[0471] Also, it may be that the designation of a particular programming language as the primary programming language may necessarily result in the corresponding adoption of various characteristics of the manner in which that primary programming language represents, stores and/or accesses data that may be unique to that primary programming language. As a result, various characteristics of the data objects **2330**, **2370** and/or **2770** that may be persistently stored within federated area(s) **2566** may be dictated by which programming language is designated to be the primary programming language. This may make the form in which data objects **2330**, **2370** and/or **2770** may be stored within the federated area(s) **2566** incompatible with task routines **2440** that are not written in the primary programming language, unless some degree of conversion is performed to change such data objects between the form associated with the primary programming language and a different form associated with a secondary programming language.

[0472] Unfortunately, and as will also be familiar to those skilled in the art, the performance of such conversions can consume considerable processing and/or storage resources, especially with larger data objects, such as larger array data structures. By way of example, one type of conversion that may need to be performed between two such forms of a data object may be serialization or de-serialization. More specifically, it may be that the primary programming language in which the executable instructions **2447** of some of the task routines **2440** are written is one that supports data objects that are persisted to federated area(s) **2566** as structured data arrays (e.g., the SAS programming language), while in contrast, the executable instructions **2447** of others of the task routines **2440** are written in a secondary language that supports data objects that take an unstructured form such as a list of comma-separated values (CSVs) that is not stored within federated areas **2566** (e.g., a NumPy array for use with Python™)

[0473] Therefore, and as will also be discussed in greater detail, to support the exchange of data object(s) between two task routines **2440** written in different programming languages, processor(s) **2550** of the federated device(s) **2500** may be caused by execution of the performance component **2544** to instantiate a shared memory space **2665** to better enable the performance of conversions on those data object (s). More specifically, where task routines **2440** written in different languages must exchange data object(s), a shared memory space **2665** may be temporarily instantiated to provide a temporary storage location in which serialization, de-serialization and/or other types of conversion may be performed with data object(s) to enable such an exchange therebetween.

[0474] Alternatively or additionally, and as will also be discussed in greater detail, to support a more efficient exchange of data objects between two task routines 2440 written in the same secondary programming language, processor(s) 2550 of the one or more federated devices 2500 may be caused by execution of the performance component 2544 to instantiate a shared memory space 2665. More specifically, where two task routines 2440 are both written in a secondary programming language associated with data object forms that are not accepted for persistent storage in federated area(s) 2566, a shared memory space 2665 may be temporarily instantiated to provide a mechanism for a more direct exchange of such data objects exchanged therebetween. This avoids a situation in which an object output by one of the task routines 2440 in a form associated with the secondary programming language is first converted into a form associated with the primary programming language for persistent storage within a federated area 2566, only to then be converted back into its original form associated with the secondary programming language to enable its use as an input to the other of the task routines 2440. In addition to enabling such a more direct exchange of the data object, in some embodiments, the data object may still be converted to a form associated with the primary programming language for persistent storage within a federated area 2566, but that conversion may be performed at least partially in parallel with the more direct exchange of the data object in its original form through the shared memory space 2665.

[0475] As will be discussed in greater detail, the processor (s) 2550 of the federated device(s) 2500 may be caused by execution of the federated area component 2546 to instantiate a container 2565 within a federated area 2566 within each of multiple storage devices 2600 as a mechanism to provide, to each of those multiple storage devices 2600, objects and/or components of the control routine 2540 (e.g., the depicted instance of the performance component 2544) that are needed to enable the processor(s) 2650 of those multiple storage devices 2600 to perform a job flow. As has been discussed, it may be that a data object is sufficiently large that it is stored in a distributed manner in a federated area 2566 that spans the storage spaces provided by multiple ones of the storage devices 2600. Indeed, the size of such a data object may cause the transmission of it into the federated device(s) 2500 from such multiple storage devices 2600 to be at least undesirable, if not prohibitively difficult. It may, therefore, be deemed more desirable to use the processing resources of those multiple storage devices 2600 to execute the task routine(s) 2440 that require such a large data object as an input, while allowing that data object to remain effectively where it already is within those multiple storage devices 2600. Thus, multiple copies of such a container 2565 may be distributed among those multiple storage devices 2600 as a mechanism to temporarily provide the much smaller task routine(s) 2440 that are to be so executed, along with other object(s) and/or other routines that may be needed (e.g., the depicted instance of the performance component 2544).

[0476] Alternatively or additionally, and as will also be discussed in greater detail, the processor(s) 2550 of the one or more federated devices 2500 may be caused by execution of the performance component 2544 to temporarily instantiate a container 2565 within a federated area 2566 to enable the processor(s) 2550 to monitor and/or verify the input and/or output operations that are caused to be performed as

a result of the execution of a particular task routine 2440. Such temporary instantiation of a container 2565 may be used in a development or diagnostic situation in which debugging, testing and/or verification of the functionality of a newly written task routine 2440 is underway.

[0477] Also alternatively or additionally, and as will also be discussed in greater detail, in some embodiments, it may be that such containers 2565 are routinely instantiated to separately support the execution of each task routine 2440 during the performance of every job flow as part of a system of managing the allocation of processing and/or storage resources of the federated device(s) 2500. More specifically, as a result of execution of a resource allocation routine 2411, it may be that a set of pods 2661 are instantiated with portions of the processing and storage resources of one or more of the federated devices 2500 allocated to each. Among such a set of pods 2661 may be a subset of pods 2661 within which at least one container 2565 may be instantiated to provide an execution environment in which a single instance of a task routine 2440 is executed to perform a single task of a job flow. Within other(s) of the pods 2661, at least one container 2565 may be instantiated to provide execution environment(s) in which instances of other routines may be executed to support the execution of the task routines 2440 as part of supporting the performance of the job flow (e.g., the performance component 2544 or the portal component 2549, as depicted).

[0478] As depicted, in some embodiments in which such a set of pods 2661 is so instantiated, it may be that shared memory spaces 2565 are instantiated within one or more of the pods 2661 in which task routines 2440 may be so executed. As explained just above such shared memory spaces 2565 may be used to support the conversions of data objects between forms associated with different programming languages, and/or such shared memory spaces may be used to enable a more efficient exchange of data objects between task routines 2440 written in the same secondary programming language.

[0479] In keeping with the earlier discussion of “perspective” in reference to FIG. 15A, it should be noted that, although pod(s) 2661, container(s) 2565 and/or shared memory space(s) 2665 are depicted and discussed as being instantiated within federated area(s) 2566, other embodiments are possible in which one or more of these may be instantiated outside of any federated area 2566. As will be described in greater detail, this may arise as a result of it being deemed desirable to have the flexibility to dynamically instantiate pod(s) 2661, container(s) 2565 and/or shared memory space(s) 2665 within storage space that is available within any one of multiple federated device(s) 2500 and/or storage device(s) 2600 at which speedier access can be provided to particular processor(s), to particular data objects (e.g., particularly large data objects that may be deemed undesirable to exchange between devices), and/or to other particular resources that may be available within a limited subset of federated device(s) 2500 and/or storage device(s) 2600. As will also be explained in greater detail, the choice of device and/or the choice of a particular storage space within which to instantiate one or more of pod(s) 2661, container(s) 2565 and/or shared memory space(s) 2665 may be associated with designations of “types” of tasks to be performed where the “type” of a task is, to at least some degree, correlated to requirements for access to particular processing, storage and/or other resources. Indeed,

and as will also be discussed, such designations of “type” of task may be further correlated to “types” of container **2565** in which particular “types” of task may be executed.

[0480] FIG. 15G depicts an example of designating at least a portion of each of multiple federated areas **2566** as a transfer area **2666**. In some embodiments, and as previously discussed in reference to FIG. 13D, such multiple transfer areas **2666** may be defined to enable the automated exchange, through synchronization, of the objects between those multiple transfer areas **2666** and counterpart transfer areas **2166** or **2866** defined within a storage **2160** or **2860** of another device **2100** or **2800**, respectively, as an approach to sharing a set of objects that are distributed across a hierarchy of federated areas **2566**. Again, such embodiments may be deemed desirable as a mechanism to enable a collaboration on the development of a relatively complex analysis routine between developers who are familiar with federated areas **2566** and the programming language(s) that may be associated therewith and other developers who are not familiar with federated areas **2566** and/or with those programming language(s).

[0481] However, either alternatively or additionally, in other embodiments, the definition of multiple transfer areas **2666**, one each in a different federated area **2566**, may be used to enable the automated transfer of specific objects from one federated area **2566** to another in response to specific conditions having been met. Such embodiments may be deemed desirable as an approach to automating the development of at least a portion of an analysis routine by causing the automated transfer of portions thereof from a federated area **2566** associated with one phase of development thereof to another as various thresholds of development, testing, accuracy, etc. are met.

[0482] FIG. 15H depicts an example embodiment of a synchronization relationship having been put in place between a set of transfer areas **2666** defined within a corresponding set of federated areas **2566**, and a set of transfer areas **2166** or **2866** defined within a storage **2160** or **2860**, respectively. More specifically, FIG. 15H depicts a multitude of synchronization relationships involving a triplet of transfer areas **2666q**, **2666u** and **2666x** defined within the triplet of federated areas **2566q**, **2566u** and **2566x**, respectively, of the example linear hierarchy of federated **2666** introduced in FIG. 15A, and involving a corresponding triplet of transfer areas **2166q/2866q**, **2166u/2866u** and **2166x/2866x** defined within a storage **2160** or **2860** of a device **2100** or **2800**, respectively.

[0483] As will be familiar to those skilled in the art, in the development of a relatively complex analysis routine, it may be deemed desirable to organize the numerous portions of executable instructions and/or other supporting portions thereof into a set hierarchy of directories and/or subdirectories that reflect distinct portions of the analysis routine that may be the responsibility of different groups of developers (e.g., a user interface group, a file management group, a core analysis group, etc.). In some embodiments, it may be that the hierarchical arrangement of directories and/or subdirectories is reflective of differing levels of security access to different portions of the executable instructions (e.g., where particular intellectual property rights may be involved for one or more particular portions), and/or it may be that the hierarchical arrangement of directories and/or subdirectories may be reflective of an order of compilation and/or linking of at least a subset of the executable instructions. Thus, and

as previously discussed, in a collaborative development of a relatively complex analysis routine between developers of two different development environments (one entailing the use of federated areas **2566** and associated primary programming language, and one not entailing the use of one or both of those), it may be desirable to enable sharing of objects that are stored across multiple ones of such directories and/or subdirectories, and across corresponding multiple ones of federated areas **2566** that may be organized into a hierarchy that corresponds (to at least some degree) to such a hierarchy of directories and/or subdirectories. To enable this, and as depicted, each of the transfer areas **2166** or **2866** may be defined to encompass storage space associated with a directory or sub-directory, and may be synchronized with a corresponding transfer area **2666** that is defined within a federated area **2566** that is meant to correspond to that same directory or sub-directory. Also, the position of each such directory or subdirectory within its hierarchy of directories and/or subdirectories may be made to correspond to the position of its corresponding federated area **2566** within its hierarchy of federated areas **2566**.

[0484] As also depicted in FIG. 15H, and as was earlier discussed in reference to FIG. 15C, it may be deemed desirable to provide each federated area **2566** in such a hierarchy of federated areas **2566** with a human-readable federated area identifier **2568** that is in some way reflective of the position of each federated area **2566** in the hierarchy, and therefore, may provide some indication of how to navigate among those federated areas **2566** within the hierarchy. As a result, and as additionally depicted in FIG. 15H, it may be that such human-readable federated area identifiers **2568** are also be reflective of the naming convention used in the hierarchy of directories and/or sub-directories, as well as how to navigate among those directories and/or subdirectories. Such a correspondence in hierarchies and naming conventions between two such environments may be deemed desirable to enable the different developers of two such environments to more easily refer to particular objects for which there may be corresponding copies and/or corresponding versions at similar locations within the corresponding hierarchies.

[0485] Turning to FIG. 15I, and as previously discussed in connection with FIG. 13E, the processor(s) **2550** of the one or more federated devices **2500** may be caused to instantiate one or more federated areas **2566** that may each be entirely constrained to exist within the storage space provided by a local file system **2663** implemented entirely within the storage **2660** of a single one of the storage devices **2600a-x**. More precisely, each such federated area **2566** may, therefore, not span across the storage spaces provided by multiple ones of the storage devices **2600a-x** in any way. As depicted, each such federated area **2566** may be limited to storing undivided objects **2220**, **2270**, **2330**, **2370**, **2440**, **2470**, **2720** and/or **2770**. As also depicted, each such federated area **2566** may include one or more storage locations designated as serving a specialized purpose, such as a container **2565**, a shared memory space **2665** or a transfer area **2666**. As also depicted, such storage of undivided objects may be within or outside of such designated storage locations, or both.

[0486] Turning to FIG. 15J, and as previously discussed in connection with FIG. 13F, the processor(s) **2550** of the one or more federated devices **2500** may be caused to instantiate one or more federated areas **2566** that may exist within a storage space provided by the distributed file system **2664**

implemented to span portions of the storage 2660 of multiple ones of the storage devices 2600a-x. More precisely, each such federated area 2566 may, therefore, span across the storage spaces provided by multiple ones of the storage devices 2600a-x. As depicted, each such federated area 2566 may be used to store undivided objects 2220, 2270, 2330, 2370, 2440, 2470, 2720 and/or 2770. However, as also depicted, each such federated area 2566 may alternatively or additionally be used to store data object blocks 2336, 2336d, 2376, 2376d, 2776 and/or 2776d of large data sets 2330, 2330d, 2370, 2370d, 2770 and 2770d, respectively, such that they are caused to span multiple ones of the storage devices 2600a-x. As also depicted, each such federated area 2566 may include one or more storage locations designated as serving a specialized purpose, such as a container 2565, a shared memory space 2665 or a transfer area 2666. As also depicted, such storage of undivided objects and/or data object blocks may be within or outside of such designated storage locations, or both.

[0487] Turning more specifically to FIG. 15K, although not specifically discussed or depicted in either of FIG. 15I or 15J, embodiments of the distributed processing system 2000 are possible in which a mixture of different federated areas 2566 may be instantiated in which one or more may exist entirely within storage space provided by a single storage device 2600, while one or more others may span across storage space provided by multiple storage devices 2600. As also more specifically depicted in FIG. 15K, it may be that such federated areas 2566 may be instantiated in which one or more may exist entirely within storage space provided by a single federated device 2500, and/or in which one or more may span across storage space provided by multiple federated devices 2500 (either in lieu of or in addition to storage within one or more storage devices 2600). Again, regardless of whether a particular federated area 2566 exists within storage space provided by a single federated device 2500 or storage device 2600, or multiple federated devices 2500 or multiple storage devices 2600, each such federated area 2566 may include one or more storage locations designated as serving a specialized purpose, such as a container 2565, a shared memory space 2665 or a transfer area 2666. As also depicted, the storage of undivided objects may be within or outside of such designated storage locations, or both.

[0488] FIGS. 16A, 16B, 16C, 16D, 16E, 16F, 16G, 16H, 16I, and 16J, 16K and 16L, together, illustrate the manner in which a set of objects may be used to define and perform an example job flow 2200fgh, as well as to document the resulting example performance 2700afg2h of the example job flow 2200fgh. FIG. 16E additionally illustrates how a container 2565 and information incorporated into one of the task routines 2440f and/or into the job flow definition 2220fgh may be used to verify the functionality of that task routine. FIG. 16F additionally illustrates how a mid-flow data set 2370fg may be converted between two forms 2370pfg and 2370sfg amidst being exchanged between two task routines to accommodate the use of different programming languages therebetween. FIG. 16G additionally illustrates how a mid-flow data set 2370fg may be directly exchanged in its 2370sfg form between two task routines written in a secondary programming language, while a conversion thereof into its 2370pfg form may also be performed, at least partially in parallel, to enable storage of the mid-flow data set 2370fg in a form that is normally accepted for storage in a federated area 2566. FIG. 16H

additionally illustrates the manner in which the job flow definition 2200pfggh may be marked as associated with another job flow definition 2200sfgh from which the job flow definition 2200pfggh may have been derived by translation from one programming language to another. FIG. 16J additionally illustrates the manner in which a job flow 2200fgh that employs non-neuromorphic processing to perform a function may be marked as associated with another job flow 2200jk that employs neuromorphic processing to perform the same function and that was derived from the job flow 2200fgh. FIGS. 16K and 16L, together, additionally illustrate the manner in which the job flow definition 2220fgh may be generated as and/or from a DAG 2270fgh. For sake of ease of discussion and understanding, the same example job flow 2200fgh and example performance 2700afg2h of the example job flow 2200fgh are depicted (or are at least associated with what is depicted) throughout all of FIGS. 16A-L. Also, it should be noted that the example job flow 2200fgh and example performance 2700afg2h thereof are deliberately relatively simple examples presented herein for purposes of illustration, and should not be taken as limiting what is described and claimed herein to such relatively simple embodiments.

[0489] Turning to FIGS. 16A and 16B, as depicted, the example job flow 2200fgh specifies three tasks that are to be performed in a relatively simple three-step linear order through a single execution of a single task routine 2440 for each task, with none of those three tasks entailing the use of neuromorphic processing. Also, the example job flow 2200fgh requires a single data set as an input data object to the first task in the linear order, may generate and exchange one or two mid-flow data sets among the tasks, and generates a single result report as an output data object of the last task in the linear order. As also depicted, in the example performance 2700afg2h of the example job flow 2200fgh, task routines 2440f, 2440g2 and 2440h are the three task routines selected to be executed to perform the three tasks. Also, a flow input data set 2330a is selected to serve as the input data object, and a result report 2770afg2h is the output data object to be generated as an output of the performance 2700afg2h. Again, it should be noted that other embodiments of a job flow are possible in which there may be many more tasks to be performed, many more data objects that serve as inputs and/or many more data objects generated as outputs. It should also be noted that other embodiments of a job flow are possible in which there is a much more complex order of the performance of tasks that may include parallel and/or conditional branches that may converge and/or diverge.

[0490] It is important to note that, within a job flow definition 2220, it is the tasks that make up the associated job flow 2200 that are specified, while the particular task routines 2440 that are executed to perform each of those tasks are not specified. Thus, in the flow definition 2225 flow task identifiers 2241 are used to uniquely identify each task that is to be performed as part of performing the associated job flow 2200, while task routine identifiers 2441 that would uniquely identify each task routine 2440 are not used. As has been discussed, this allows the selection of particular task routines 2440 that will be executed to perform each task to be forestalled until the time that each task is to be performed, thereby enabling the most recent version of task routine 2440 be selected and used to perform each task. This may occur as the default manner of selecting versions of task

routines **2440** to perform each task, as will be explained in greater detail. As an exception to such a default manner of selecting versions of task routines **2440**, a request may be received to repeat an earlier performance of a job flow **2200** in a manner intended to recreate the same conditions of that earlier performance, including the use of the same versions of task routines **2440** as were used in that earlier performance.

[0491] Also within the flow definition **2225** may be indications of data dependencies among the tasks that are identified therein using flow task identifiers **2241**. In a manner similar to the specification of tasks, rather than particular task routines, such data dependencies may be indicated within the flow definition **2225** in a manner that does not involve the use of identifiers of specific data objects (e.g., specific flow input data sets **2330**, specific mid-flow data sets **2370** and/or specific result reports **2770**) so as to allow the associated job flow **2200** to be performed using any data objects that may be desired. Thus, in this way, at least input data sets **2330** used as inputs to a performance of a job flow **2200** are able to be specified in each request that is made to perform that job flow **2200**.

[0492] It should also be noted that, in some embodiments, and as depicted, each of the flow task identifiers **2241** may incorporate (or be otherwise accompanied by) task type identifiers **2242** that each uniquely specify a type of the corresponding task. Stated differently, in some embodiments, the tasks that may be specified to be performed as part of performing a job flow **2200** may be divided into a selection of types that may be based on any of a variety of aspects that may differ among those tasks. By way of example, in some embodiments, it may be that a subset of the tasks that may be specified to be performed as part of performing a job flow require the provision of a particular service and/or a specialized hardware component that may be available within just a subset of the federated devices **2500** and/or within just a subset of the storage devices **2600**. Such a particular service may include and/or require features unique to a particular file system that may be used in a subset of the storage devices **2600**, and/or such a specialized hardware component may be a GPU that may be present in a subset of the federated devices **2500**. Alternatively or additionally, in some embodiments, it may be that a subset of the tasks that may be specified to be performed require access to particular licensed and/or encrypted data objects where such access requires the performance of that subset of tasks within a particular type of container environment **2565** and/or within a particular federated device **2500** or storage device **2600** that has access to such licensed and/or encrypted data objects.

[0493] Therefore, the job flow definition **2220/gh** for the example job flow **2200/gh** may include a flow definition **2225** that specifies the three tasks to be performed, the order in which they are to be performed as a result of dependencies thereamong, which of the three tasks is to accept a data object (e.g., a flow input data set **2330**) as an input and/or generate a data object (e.g., a result report **2770**) as an output, and/or a task type for one or more of the three tasks. Again, in specifying the three tasks to be performed, the flow definition **2225** may use the depicted flow task identifiers **2241/f**, **2241/g** and **2241/h** that uniquely identify each of the three tasks (which again, may each include, or be otherwise accompanied by, a task type identifier **2242**). As depicted, there may be just a single task routine **2440/f** available among

one or more federated areas **2566** to which access is granted that is able to perform the task specified with the flow task identifier **2241/f**, and therefore, the single task routine **2440/f** may be the one task routine that is assigned the flow task identifier **2241/f** to provide an indication that it is able to perform that task. Also, there may be up to three task routines **2440/g1**, **2440/g2** and **2440/g3** available among the one or more accessible federated areas **2566** that are each able to perform the task specified with the flow task identifier **2241/g**, and therefore, each may be assigned the same flow task identifier **2241/g**. Further, there may be just a single task routine **2440/h** available within the one or more accessible federated areas **2566** that is able to perform the task specified with the flow task identifier **2241/h**, resulting in the assignment of the flow task identifier **2241/h** to the single task routine **2440/h**.

[0494] As has been discussed, the job flow definition **2220/gh** specifies the tasks to be performed in a job flow, but does not specify any particular task routine **2440** to be selected for execution to perform any particular one of those tasks during any particular performance of the job flow. Where there are multiple task routines **2440** available that are each capable of performing a particular task, a single one of those multiple task routines **2440** is selected for execution to do so, and the selection that is made may, in part, depend on the nature of the request received to perform a job flow. Again, it may be that, by default, the selection of a particular task routine **2440** for execution to perform each particular task is based on which task routine **2440** is the newest version to perform each task, and/or may be based on which task routine **2440** was used in a previous performance of each task in a specified previous performance of a job flow. Again, the selection criteria that is used to select a task routine **2440** for each task may depend on whether an entirely new performance of a job flow is requested or a repetition of an earlier performance of a job flow is requested. As depicted, in the example performance **2700/afg2h** of the example job flow **2200/gh**, the task routine **2440/g2** is selected from among the task routines **2440/g1**, **2440/g2** and **2440/g3** for execution to perform the task identified with the flow task identifier **2241/g**.

[0495] Alternatively or additionally, and as previously explained in connection with FIGS. **15A-B**, in situations in which objects needed for the performance of a job flow are distributed among multiple federated areas that are related by inheritance and/or priority relationships, the selection of a particular task routine **2440** to perform a task from among multiple task routines **2440** that are each capable of performing that same task may, in part, be dependent upon which federated area **2566** each of such multiple task routines **2440** are stored within. By way of example, FIG. **16C** depicts an example situation in which objects needed to perform the job flow **2200/gh** are distributed among the federated areas **2566/m**, **2566/u** and **2566/x** in the example hierarchical tree of federated areas first introduced in FIGS. **15B-C**. More specifically, in this example, the data set **2330a** and the task routine **2440/g2** are stored within the private federated area **2566/m**; the task routine **2440/g3** is stored within the intervening federated area **2566/u**; and the data set **2330b** and the task routines **2440/f**, **2440/g1** and **2440/h** are stored within the base federated area **2566/x**.

[0496] As previously discussed in reference to the linear hierarchy depicted in FIG. **15A**, a “perspective” from which a job flow is to be executed may be based on which federated

areas **2566** are made accessible to the device and/or device user that makes the request for the performance to occur. As depicted, where the request to perform the job flow **2200/gh** is received from a user granted access to the private federated area **2566m**, as well as to the base federated area **2566x**, but not granted access to any of the federated areas **2566q**, **2566r** or **2566u**, the search for objects to use in the requested performance may be limited to those stored within the private federated area **2566m** and the base federated area **2566x**. Stated differently, the perspective that may be automatically selected for use in determining which federated areas **2566** are searched for objects may be that of the private federated area **2566m**, since the private federated area **2566m** is the one federated area to which the user in this example has been granted access to that is subject to the most restricted degree of access. Based on this perspective, the private federated area **2566m** will be searched, along with the base federated area **2566x**, and along with any intervening federated areas **2566** therebetween, if there were any federated areas **2566** therebetween.

[0497] As a result, the task routine **2440g3** stored within the intervening federated area **2566u** is entirely unavailable for use in the requested performance as a result of the user having no grant of access to the intervening federated area **2566u**, and this then becomes the reason why the task routine **2440g3** is not selected. In contrast, as a result of an inheritance relationship between the private federated area **2566m** and the base federated area **2566x**, the data set **2330b** and each of the task routines **2440f**, **2440g1** and **2440h** stored in the based federated area **2566x** may each be as readily available for being used in the requested performance of the job flow **2200/gh** as the data set **2330a** and the task routine **2440g2** stored in the private federated area **2566m**. Therefore, the task routines **2440f** and **2440h** may be selected as a result of being the only task routines available within either federated area **2566m** or **2566x** that perform their respective tasks. However, although both of the flow input data sets **2330a** and **2330b** may be equally available through that same inheritance relationship, a priority relationship also in place between the federated areas **2566m** and **2566x** may result in the data set **2330a** being selected as the data set used as input, since the flow input data set **2330a** is stored within the private federated area **2566m**, which is searched first for the objects needed for the requested performance, while the flow input data set **2330b** is stored within the base federated area **2566x**, which is searched after the search of the private federated area **2566m**. The same combination of inheritance and priority relationships in place between the federated areas **2566m** and **2566x** may also result in the task routine **2440g2** stored within the private federated area **2566m** being selected, instead of the task routine **2440g1** stored within the base federated area **2566x**.

[0498] Turning more broadly to FIGS. 16A and 16D, the selected task routines **2440f**, **2440g2** and **2440h** may each include various interfaces **2443** and/or **2444** at which data may be received as an input and/or generated as an output. As depicted for the example job flow **2200/gh**, among these various interfaces may be a data interface **2443** by which the selected task routine **2440f** may receive the selected flow input data set **2330a** provided as an input to the whole of the job flow **2200/gh**, as well as an input to the task routine **2440f**, itself. Also among these various interfaces may be a data interface **2443** by which the selected task routine **2440h**

may provide the result report **2770afg2h** as an output of the whole of the job flow **2200/gh**, as well as an output of the task routine **2440h**, itself. As also depicted, among these various interfaces may be further data interfaces **2443** and/or task interfaces **2444** by which a mid-flow data set **2370fg** may be exchanged between the pair of selected task routines **2440f** and **2440g2**, and/or by which a mid-flow data set **2370gh** may be exchanged between the pair of selected task routines **2440g2** and **2440h**.

[0499] As depicted, the job flow definition **2220/gh** for the example job flow **2200/gh** may include interface definitions **2224** that define various aspects of each such interface **2443** and/or **2444**, including and not limited to, data type, data size, data format, data structure, data encoding, etc. of whatever type of data may pass therethrough. Since many of the specified aspects of an interface **2443** and/or **2444** may necessarily be closely associated with the manner in which data items are organized and made accessible within whatever type of data that may pass therethrough, the interface definitions **2224** may additionally include organization definitions **2223** that specify such organizational and access aspects of the data objects. Thus, as depicted in FIG. 16D, where each of the data objects **2330a**, **2370fg**, **2370gh** and/or **2370/g** may include a two-dimensional array of data items **2339** organized into rows **2333** and columns **2334**, the organization definitions **2223** may specify various aspects of the data items **2339** (e.g., data type, bit width, etc.), and/or the manner in which the data items **2339** are organized (e.g., the depicted rows **2333** and/or the columns **2334**) for each of these data objects. Additionally, and as also depicted, one or more of such data objects may incorporate metadata **2338** that may also describe aspects of the data objects **2339** and/or aspects of the manner in which the data objects **2339** are organized. In some embodiments, it may be that comparisons are made between such aspects as specified in the metadata **2338** and such aspects as specified in the organization definitions **2223** to ensure compatibility between data objects and data interfaces **2443**.

[0500] In some embodiments, it may be required that an exchange of data between two tasks within a job flow giving rise to a data dependency therebetween must be expressed within the flow definition **2225** as a combination of one task outputting a data object through a data interface **2443** that serves as an output interface, and the other task receiving that same data object through a data interface **2443** that serves as an input interface. This expression of such a dependency in which the exchanged data object is explicitly referenced is reflected in FIG. 16D by the example depictions of the pairs of data interfaces **2443** by which the task routines **2440f** and **2440g2** may exchange the explicitly referenced mid-flow data set **2370fg**, and/or by which the task routines **2440g2** may exchange the explicitly referenced mid-flow data set **2370gh**. Such a requirement of such explicit references to such exchanged data objects may be deemed desirable as an approach to ensure clarity in the manner in which data dependencies are expressed within the flow definition **2225**.

[0501] However, in other embodiments, it may be permitted to express an exchange of a data object between two tasks in an implied manner in which a data dependency between two tasks is expressed as one task being received by the other task through a task interface **2444** serving as an input of the other task. In essence, the one task is referred to as if, itself, were the data object that is to be received by

the other task. Thus, the one task is essentially treated, in this alternate syntax, as if it were a data object, and not as if it were a task, even though the functional result is that both tasks will be treated, for purposes of execution, as tasks that exchange a data object between them. This expression of such a dependency in which no actual data object is explicitly referenced is reflected in FIG. 16D by the alternate example depictions of the pairs of task interfaces **2444** by which exchanges of data object are implied between the task routines **2440f** and **2440g2**, and between **2440g2** and **2440h**.

[0502] Whether the manner in which the dependencies between the task routines **2440f** and **2440g2** and between the task routines **2440g2** and **2440h** are expressed within the flow definition **2225** entails an explicit reference to the exchanged data objects, or not, there may be no functional difference in what occurs during runtime. More specifically, during performance of the depicted example job flow **2200fgh**, the mid-flow data set **2370fg** may still be generated by the task routine **2440f** and provided to the task routine **2440g2**, and the mid-flow data set **2370gh** may still be generated by the task routine **2440g2** and provided to the task routine **2440h**. There may be just a difference in syntax used in the flow definition **2225**.

[0503] As previously discussed, the job flow definition **2220fgh** specifies tasks to be performed and not the particular task routines **2440** to be selected for execution to perform those tasks, which provides the flexibility to select the particular task routines **2440** for each task dynamically at the time a performance takes place. Similarly, the job flow definition **2220fgh** may also not specify the particular data objects to be received as input to the performance of the job flow **2200fgh** and/or to be generated as output by the performance of the job flow **2200fgh**, which provides the flexibility to select those particular data objects dynamically at the time a performance of the job flow **2200fgh** takes place.

[0504] The specification of aspects of the interfaces **2443** and/or **2444** may be deemed desirable to ensure continuing interoperability among task routines **2440**, as well as between task routines **2440** and data objects, in each new performance of a job flow **2200**, even as new versions of one or more of the task routines **2440** and/or new data objects are created for use in later performances. In some embodiments, new versions of task routines **2440** that may be created at a later time may be required to implement the interfaces **2443** and/or **2444** in a manner that exactly matches the specifications of those interfaces **2443** and/or **2444** within a job flow definition **2220**.

[0505] However, in other embodiments, a limited degree of variation in the implementation of the interfaces **2443** and/or **2444** by newer versions of task routines **2440** may be permitted as long as “backward compatibility” is maintained in retrieving input data objects or generating output data objects through data interfaces **2443**, and/or in communications with other task routines through task interfaces **2444**. As will be explained in greater detail, the one or more federated devices **2500** may employ the job flow definitions **2220** stored within one or more federated areas **2566** to confirm that new versions of task routines **2440** correctly implement task interfaces **2444** and/or data interfaces **2443**. By way of example, in some embodiments, it may be deemed permissible for an interface **2443** or **2444** that receives information to be altered in a new version of a task routine **2440** to accept additional information from a newer

data object or a newer version of another task routine **2440** if that additional information is provided, but to not require the provision of that additional information, since older data objects don’t provide that additional information. Alternatively or additionally, by way of example, it may be deemed permissible for an interface **2443** or **2444** that outputs information to be altered in a new version of a task routine **2440** to output additional information as an additional data object generated as an output, or to output additional information to a newer version of another task routine **2440** in a manner that permits that additional information to be ignored by an older version of that other task routine **2440**.

[0506] Returning to FIGS. 16A and 16B, an example instance log **2720afg2h** that is generated as result a of the example performance **2700afg2h** of the example job flow **2200fgh** is depicted. It is important to note that, while the job flow definition **2220fgh** serves to provide the information needed to perform the job flow **2200fgh**, it is the instance log **2720afg2h** that serves to document the details of a single instance of the performance **2700afg2h**. It is also important to note that it is possible for the performance **2700afg2h** to be repeated using all of the same data objects, task routines, etc. such that there can be multiple instances of the performance **2700afg2h**. More specifically, and as described elsewhere herein as part of supporting accountability in the development of job flows, a repeat of the performance of a job flow may be requested as part of an approach to searching for and/or diagnosing potential malfunctions, programming errors and/or other issues that may have arisen during the original performance of that same job flow. By way of example, a performance of a job flow may be repeated to confirm the results achieved in the original performance. Both the original performance and the repeated performance are each a separate instance of the same performance of a job flow. Therefore, while the job flow definition **2220fgh** does not specify particular data objects or task routines **2440** to be used in any performance of the example job flow **2200fgh**, the example instance log **2720afg2h** does include such specific details as part of documenting a single instance that has occurred of the example performance **2700afg2h**.

[0507] Thus, the example instance log **2720afg2h** includes the job flow identifier **2221fgh** for the example job flow definition **2220fgh** to identify the definition of the job flow **2200fgh** that was performed, and the instance log **2720afg2h** also includes a job flow instance identifier **2701** that uniquely identifies a single instance that has occurred (and that is documented) of the performance **2700afg2h** of the job flow **2200fgh**. The instance log **2720afg2h** also includes a flow description **2725** that documents the step-by-step of what occurred during the instance of performance that the instance log **2720afg2h** documents. Thus, the flow description **2725** includes the task routine identifiers **2441f**, **2441g2** and **2441h** that identify the particular task routines **2440f**, **2440g2** and **2440h**, respectively, that were executed in that instance of the performance **2700afg2h**; the data object identifier **2331a** to identify the data set **2330a** that was used as an input data object in that instance of the performance **2700afg2h**; and the result report identifier **2771afg2h** to identify the result report **2770afg2h** that was generated during the example performance **2700afg2h**. Again, the instance log **2720afg2h** is intended to serve as a record of sufficient detail concerning a past instance of the performance **2700afg2h** as to enable all of the objects associated

with that past instance to be later identified, retrieved and used to repeat the performance **2700afg2h** (i.e., cause a new instance of the performance **2700afg2h** to occur). In contrast, the job flow definition **2220fgh** is intended to remain relatively open-ended for use with a variety of data objects and/or with a set of task routines **2440** that may change over time as improvements are made to the task routines **2440**.

[0508] Returning more specifically to FIG. 16B, as will be explained in greater detail, it may be that, during a performance of a job flow, each instance of performance of one of the tasks thereof may also be assigned a unique identifier, such as the depicted task instance identifiers **2704**. Further, in some embodiments, and as depicted, it may be that the task instance identifiers **2704** are also included in an instance log as part of documenting each instance of performance of each task. As will also be explained in greater detail, it may be that the job flow instance identifier **2701**, the task instance identifiers **2704**, and/or still other identifiers associated with an instance of a performance of a job flow may be used to coordinate the performance of various operations during a job flow performance. Alternatively or additionally, such identifiers may be used in providing a more granular indication of the status of an instance of a job flow performance that is currently underway.

[0509] Turning to FIG. 16E, and as previously discussed, in some embodiments, the input/output behavior of one or more of the task routines **2440** that have been selected to be executed in performing the job flow **2200fgh** may be verified by being monitored during the performance of the job flow **2200fgh**, with the observed input/output behavior being compared to the expected input/output behavior. More specifically, and as depicted as an example, the processor(s) **2550** may be caused by execution of the performance component **2544** of the control routine **2540** to instantiate a container **2565** within which a task routine **2440** (e.g., the depicted task routine **24400**) is to be executed. The processor (s) **2550** may then be further caused to execute the executable instructions **2447** of the task routine **2440f** within the execution environment of the container **2565** to enable monitoring of the input/output behavior that is caused to occur as a result, as well as to enable such input/output behavior to be compared to the input/output behavior that is expected. In so doing, the interface definitions **2224** within the job flow definition **2220fgh**, the comments **2448** of the task routine **2440f**, and/or the particular ones of the executable instructions **2447** that implement each of the depicted interfaces **2443** and **2444** of the task routine **2440f**, may be employed by the performance component **2544** as a reference for those interfaces of the task routine **2440f** from which the expected behavior may be derived.

[0510] In some embodiments, the instantiation of the container environment **2565** may be done to also create an execution environment for the task routine **2440f** in which the expected input/output behavior is not simply monitored and compared to the expected behavior, but is actually also enforced upon the task routine **2440f** such that any aberrant input/output behavior by the task routine **2440f** is not allowed to be fully performed (e.g., attempted input/output accesses to data structures and/or input/output devices that go beyond the expected input/output behavior are prevented from actually taking place). Where the observed input/output behavior conforms to the expected input/output behavior, the input/output functionality of the task routine **2440f** may be deemed to have been verified.

[0511] Regardless of whether the container **2565** enforces expected input/output behavior in addition to monitoring the input/output behavior that actually occurs, the results of the comparison between the observed input/output behavior and the expected input/output behavior (e.g., whether the input/output functionality of the task routine **2440f** is verified, or not) may be recorded in any of a variety of ways. By way of example, in embodiments in which each task routine **2440** is stored within one or more federated areas **2566** through use of a database to enable more efficient retrieval of task routines **2440**, the results of this comparison for the task routine **2440f** may be marked in an entry maintained by such a database for the task routine **2440f**. Alternatively or additionally, where a DAG **2270** is generated that includes a visual representation of the task routine **2440f**, that representation may be accompanied by a visual indicator of the results of this comparison.

[0512] As has been discussed, the performance of a job flow that includes the execution of the depicted task routine **2440f** may be carried out with a “perspective” based on which federated area(s) **2566** that access has been granted to, and in so doing, the depicted task routine **2440f** may be executed within such a federated area **2566** where access has been granted. Correspondingly, it may therefore be that the container **2565** in which the depicted task routine **2440f** is executed may be instantiated within that federated area **2566**. However, in other embodiments, such a container **2565**, while being associated with such a perspective, may not actually be instantiated within any federated area **2566**. Instead, the exact choice of storage space in which container (s) **2565** may be instantiated may be determined based on other factors, as will be described in greater detail. By way of example, and as will also be explained in greater detail, it may also be that all task routines **2440** are to be executed within separate containers **2565** that are instantiated as part of a system for the allocation of processing, storage and/or other resources of one or more of the devices **2500** and/or **2600**.

[0513] Turning to FIG. 16F, as previously discussed, in some embodiments, the combination of task routines **2440** that are executed during the performance of a job flow **2200** may include task routines **2440** with executable instructions **2447** and/or comments **2448** written in differing programming languages with the differing syntax, vocabulary, formatting and/or semantic features thereof. More specifically, and as depicted, the task routine **2440f** may have been written in a secondary programming language that, despite not being the primary programming language that is normally interpreted by the processor(s) **2550** of the federated device(s) **2500** at runtime, may still be capable of being so interpreted at runtime (either in addition to or in lieu of the primary programming language) such that the task routine **2440f** is designated as task routine **2440sf**. Therefore, within the task routine **2440sf**, the executable instructions **2447** may be written in the secondary programming language, and the comments **2448** may be written with the syntax used to distinguish comments from executable instructions in the secondary programming language.

[0514] As will be familiar to those skilled in the art, among the differences between different programming languages may be support for different data types and/or differences in array types, including differences in data types of items of data within arrays and/or differences in accessing items of data therein. Thus, although the executable instruc-

tions **2447** of the task routine **2440sf** may have been written to implement the depicted data input and output interfaces **2443** to receive the flow input data set **2330a** and to generate the mid-flow data set **2370g** as an output, there may be differences between the primary form of the flow input data set **2330pa** that is stored in the depicted federated area **2566** and the secondary form **2330sa** that is able to be accepted as an input, and between the primary form of the mid-flow data set **2370sfg** that is generated as an output and the primary form **2370pfg** that is stored in the depicted federated area **2566**.

[0515] To resolve such differences, the performance component **2544** may perform a conversions of data structures and/or data types (e.g., serialization or de-serialization) of the flow input data set **2330a** from its primary form **2330pa** to its secondary form **2330sa**, and of the mid-flow data set **2370fg** from its secondary form **2370sfg** to its primary form **2370pfg** during runtime. More precisely, the performance component **2544** may temporarily instantiate a shared memory space(s) **2665** within which such differing forms of the flow input data set **2330a** and of the mid-flow data set **2370fg** may be temporarily stored for the performance of such conversions during the performance of the job flow **2200f**. As has been discussed, it may be deemed desirable to store mid-flow data sets **2370** that are generated during the performance of a job flow as part of enabling a subsequent analysis of, and/or accountability for, the performance of individual tasks of that job flow by having the mid-flow data sets thereof **2370** preserved in federated area(s) **2566** along with other objects associated with that job flow. With a particular programming language having been designated as the primary programming language, it may be deemed preferable to store the mid-flow data set **2370fg** in just its primary form **2370pfg**, and to not consume valuable storage space in a federated area **2566** by also storing both forms. Thus, while the mid-flow data set **2370fg** may be persisted in the depicted federated area **2566** in the primary form **2370pfg**, the secondary form **2370sfg** may be discarded as part of un-instantiating the shared memory space **2665** in which the conversion from secondary form **2370sfg** to primary form **2370pfg** took place when the performance of the job flow **2200fgh** is completed.

[0516] Again, in some embodiments, the depicted container **2565** in which the task routine **2440sf** is executed may be instantiated within a federated area **2566** as part of the job flow **2200fgh** being performed with a “perspective” based on which federated area(s) **2566** that access has been granted to. However, again, in other embodiments, such a container **2565**, while being associated with such a perspective, may not actually be instantiated within any federated area **2566**. Also again, in some embodiments, it may also be that all task routines **2440** are to be executed within separate containers **2565** that are instantiated as part of a system for the allocation of processing, storage and/or other resources of one or more of the devices **2500** and/or **2600**. In such embodiments, it may be that such shared memory space(s) **2665** are either instantiated directly within one or more containers **2565**, or are instantiated to be otherwise accessible from within one or more **2565** in which task routines **2440** are executed.

[0517] Turning to FIG. 16G, as also previously discussed in connection with embodiments in which combinations of task routines **2440** may be executed that include executable instructions **2447** and/or comments **2448** written in differing

programming languages, a situation may arise in which a pair of task routines **2440** written in a secondary programming language are to be executed sequentially with data object(s) output by one to be used as input to the other. Again, among the differences between different programming languages may be support for different data types and/or differences in supported array types, including differences in the data types of data values within arrays and/or differences in accessing data values therein. As a result, in embodiments in which data objects are stored within federated areas **2566** in a form that matches such aspects of a primary programming language, one or more conversions may need to be performed where a data object output by a task routine **2440** written in a secondary programming language is to be stored within a federated area **2566**. Similarly, one or more conversions may need to be performed where a data object stored within a federated area **2566** is to be retrieved therefrom for use as an input to a task routine **2440** written in a secondary programming language.

[0518] Again, such conversions performed on data objects (e.g., serialization or de-serialization) may consume considerable processing and/or storage resources, and accordingly, may consume a considerable amount of time to perform. Thus, where a data object is to be exchanged between two task routines **2440** that are both written in the same secondary programming language, it may be deemed desirable to simply allow that data object to be exchanged directly therebetween to avoid the consumption of resources and time that would be incurred to perform both a conversion and then a reversal of that conversion on that data object. However, as has also been previously discussed, it may be deemed desirable to store mid-flow data sets **2370** that are generated during the performance of a job flow as part of enabling a subsequent analysis of the performance of individual tasks of that job flow by having the mid-flow data sets thereof **2370** preserved in federated area(s) **2566** along with other objects associated with that job flow.

[0519] As an approach to at least reduce the consumption of resources and time where a data object is to be exchanged between two task routines **2440** written in a secondary programming language, it may be that a shared memory space **2665** is instantiated as a mechanism to enable a direct exchange of that data object between those two task routines **2440**, and to enable the performance of the conversion(s) required to generate a form of the data object suitable for storage within a federated area **2565**. In this way, the performance of reversal(s) of those conversion(s), and resulting consumption of resources and time, may be entirely avoided. The more direct exchange of the mid-flow data set **2370sfg** and the generation of the corresponding mid-flow data set **2370pfg** therefrom may be performed at least partially in parallel to minimize delays in the commencement of the execution of the task routine **2440sg2**, and accordingly, the use of the mid-flow data set **2370sfg** as input thereto.

[0520] It should be noted that the use of the shared memory space **2665** to effect a more direct exchange of a data object between two task routines **2440** may also enable an increase in efficiency in such a transfer by enabling the transfer to be performed in a manner that avoids the generation of copies of the data object. More specifically, the shared memory space **2665** may be used by one of the task routines **2440** as the location at which the data object is directly generated “in situ” within the shared memory space

2665, instead of being generated elsewhere within a different storage location and then copied into the shared memory space **2665**. Then, the same shared memory space **2665** may be used by the other of the task routines **2440** as the location from which the data object is directly used as an input such that various operations may be performed directly on the data object, also “in situ” within the shared memory space **2665**, instead of being copied from the shared memory space **2665** to a different storage location where those various operations would be performed on that data object.

[0521] Stated differently, the shared memory space **2665** represents an area of storage space that is at least directly accessible to both of a pair of sequentially executed task routines **2440** where one task routine **2440** generates and leaves a data object in place for the other task routine **2440** directly manipulate in the same place. As part of enabling this, it may be that the shared memory space **2665** is instantiated within storage space that, at first, overlaps (either fully or partially) the storage space of the container **2565** within which the first task routine **2440** of the pair is executed, and then, is overlapped (either fully or partially) by the storage space of the container **2565** within which the second task routine **2440** of the pair is executed. Where the pair of task routines **2440** are sequentially executed, one after the other, within the same container **2565**, then the shared memory space **2665** may simply be instantiated within storage space that overlaps (either fully or partially) the storage space of that one container **2565**. As a result of such overlapping of storage spaces, it may be that such a mechanism of exchanging a data object is not able to be used in a situation in which more than one task routine **2440** is to receive the same data object as an input, since this would likely result in conflicts among those multiple receiving task routines **2440** as they each access the very same data object at the very same location.

[0522] The shared memory space **2665** may remain instantiated for a relatively limited period of time sufficient to enable such a direct exchange and performance of conversion(s) to take place. When the shared memory space **2665** is uninstantiated, the original form of the data object may cease to be stored, altogether, such that no storage space continues to be occupied by it.

[0523] Again, in some embodiments, the depicted containers **2565** in which the task routines **2440_{sf}** and **2440_{sg2}** are executed may be instantiated within a federated area **2566** as part of the job flow **2200_{fgh}** being performed with a “perspective” based on which federated area(s) **2566** that access has been granted to. However, again, in other embodiments, such containers **2565**, while being associated with such a perspective, may not actually be instantiated within any federated area **2566**. Also again, in some embodiments, it may also be that all task routines **2440** are to be executed within separate containers **2565** that are uninstantiated as part of a system for the allocation of processing, storage and/or other resources of one or more of the devices **2500** and/or **2600**. In such embodiments, it may be that any of a variety of coordinating mechanisms may be used to cause such a sequentially executed pair of task routines **2440** as the depicted task routines **2440_{sf}** and **2440_{sg2}** to be executed within the same container **2565**, or to at least increase the likelihood of being executed within the same container **2565**.

[0524] Turning to FIG. 16H, as previously discussed, it may be that portion(s) of one or more objects of a job flow

2200 were originally written in a secondary programming language that differs from the primary programming language that is relied upon by the processor(s) **2550** of the one or more federated devices **2500** to perform job flows **2200**. In such situations, and as will be discussed in more detail, such portions of such objects may be translated from such a secondary programming language and to the primary programming language, and this may result in the generation of a translated form of each of such objects in which the portion(s) written in the secondary programming language are replaced with corresponding portions in the primary programming language. It may be deemed desirable to be able to trace where a translated form of an object came from by including an identifier of the original form of the object from which the translated form was generated.

[0525] More specifically, it may be that portions of the job flow definition **2220_{fgh}** introduced in FIG. 16A were originally written in a secondary programming language as the job flow definition **2220_{sfgh}**. As depicted, such portions may include the depicted interface definitions **2224_s** (which may include the organization definitions **2223_s**) and/or the GUI instructions **2229_{sfgh}**. As depicted, such portions may be translated from the secondary programming language to the primary programming language that will be utilized during the performance **2700_{afg2h}** (e.g., the interface definitions **2224_s** and/or the GUI instructions **2229_{sfgh}** may be translated to generate the interface definitions **2224_p** and/or the GUI instructions **2229_{pfgh}**, respectively). In so doing, a form of the job flow definition **2220_{fgh}** written in the primary programming language as the job flow definition **2220_{pfgh}** may be generated from the secondary form **2220_{sfgh}**. As a measure to enable accountability for the accuracy of the translation(s) that are so performed, the primary form **2220_{pfgh}** may be generated to additionally include the job flow identifier **2221_{sfgh}** that identifies the secondary form **2220_{sfgh}**. Additionally, it may be that the secondary form **2220_{sfgh}** is maintained in a federated area **2566** along with the primary form **2220_{pfgh}**.

[0526] It may also be that other portions of the job flow definition **2220_{fgh}** may be written in the secondary programming language in the sense that they are written as comments that are written in a manner that adheres to the syntax of the secondary programming languages as comments. Thus, while not actually including executable instructions, such other portions may still be regarded as having been written in the secondary programming language. As depicted, such other portions may include the depicted job flow identifier **2221_{sfgh}** and/or the flow definition **2225_s**. As also depicted, such other portions may be translated from the secondary programming language to the primary programming language that will be utilized during the performance **2700_{afg2h}** (e.g., the job flow identifier **2221_{sfgh}** and/or the flow definition **2225_s** may be translated to generate the job flow identifier **2221_{pfgh}** and/or the flow definition **2225_p**, respectively). More precisely, the syntax of such portions may be translated from the syntax for comments written in the secondary programming language and into the syntax for comments written in the primary programming language.

[0527] Turning to FIG. 16I, as previously discussed, in some embodiments, the processing resources of multiple storage devices **2600** may be employed to perform a job flow (e.g., the job flow **2200_{fgh}**) as an approach to avoiding the transmission of a large data set (e.g., the flow input data set

2330a) from the multiple storage devices **2600** and to the one or more federated devices **2500** to enable the processing resources of the one or more federated devices **2500** to be so used. Again, making such use of the processing resources of the multiple storage devices **2600** may be deemed desirable to avoid incurring the overhead of transmitting such a large data set to one or more federated devices **2500**, as the incurring of such overhead may overwhelm any benefit that may be realized by using what may be superior processing resources incorporated into the federated device(s) **2500**.

[0528] However, as also previously discussed, while such a large data set may be stored in a manner that spans multiple storage devices **2600** such that each of those multiple storage devices **2600** has local access to at least one block of that data set, other objects required to perform the job flow may be sufficiently small in size (e.g., smaller than a predetermined threshold size) that they may each have been stored as an undivided object within storage space provided by a single storage device **2600**. As a result, such smaller objects may be stored in just a subset of those multiple storage devices **2600**, and/or may be stored within still storage device(s) **2600** that do not store any of the blocks of the data set. Among such smaller objects may be smaller data objects, objects that define aspects of task(s) to be performed (e.g., a job flow definition **2220**), and/or copies of routines required to cause and/or control the performance of either a single task or an entire job flow (e.g., the performance component **2544** of the control routine **2540**).

[0529] To address such issues, the one or more federated devices **2500** may retrieve each of the other (smaller) objects required to perform the job flow, and may generate a container **2565** within which the one or more federated devices may include such other smaller objects (e.g., the job flow definition **2220fgh** and one or more task routines, such as the task routine **2440f**, as depicted) within the container **2565**, along with a copy of such routines (e.g., the performance routine **2544**, as depicted). The one or more federated devices **2500** may then transmit a copy of the container **2565**, including all of such contents therein, to each of the multiple storage devices **2600** in which a block of the large data set is stored to enable the multiple storage devices **2600** to perform the job flow, at least partially in parallel, using the block(s) of the large data set locally stored within each as an input.

[0530] As has additionally been discussed, as a result of such at least partially parallel performances by each of the multiple storage devices **2600**, a block of data of another data set may be generated (e.g., the depicted data object block **2376g**) within each of the multiple storage devices **2600** for each block of the large data set that is stored therein (e.g., for each one of the depicted data object block **2336d**). As part of storing the data object to which these newly generated blocks belong (e.g., the depicted mid-flow data set **2370g**), each of these newly generated blocks may be provided to the federated device(s) **2500** to be assembled together (e.g., in a reduction operation) to form a newly generated data object. The processor(s) **2550** of the federated device(s) **2500** may then analyze the resulting assembled data object to determine whether it is to be stored as an undivided object or in a distributed manner (e.g., whether its size is large enough to warrant being stored in a distributed manner).

[0531] As depicted, such a container **2565** that is distributed to each of the multiple storage devices **2600** may be

stored within a federated area **2566** within each. Further, the at least partially parallel executions of the separate copies of the performance component **2544** and/or the task routine **2440** included within the copies of the container **2565** (e.g., the depicted task routine **2440f**) may also be performed within their respective copies of the container **2565** within the respective federated areas **2566** within which they are stored.

[0532] Turning for FIG. **16J**, a new job flow that employs neuromorphic processing (i.e., uses a neural network to implement a function) may be derived from an existing job flow that does not employ neuromorphic processing (i.e., does not use a neural network, and instead, uses the execution of a series of instructions to perform the function). This may be done as an approach to creating a new job flow that is able to be performed much more quickly (e.g., by multiple orders of magnitude) than an existing job flow by using a neural network in the new job flow to perform one or more tasks much more quickly than may be possible through the non-neuromorphic processing employed in the existing job flow. However, as those skilled in the art will readily recognize, such a neural network may need to be trained, and neuromorphic processing usually requires the acceptance of some degree of inaccuracy that is usually not present in non-neuromorphic instruction-based processing in which each step in the performance of a function is explicitly set forth with executable instructions.

[0533] Such training of a neural network of such a new job flow may entail the use of a training data set that may be assembled from data inputs and data outputs of one or more performances of an existing job flow. Such a training data set may then be used, through backpropagation and/or other neuromorphic training techniques, to train the neural network. Further, following such training, the degree of accuracy of the neural network in one or more performances of the new job flow may be tested by comparing data outputs of the existing and new job flows that are derived from identical data inputs provided to each. Presuming that the new job flow incorporating use of the neural network is deemed to be accurate enough to be put to use, there may still, at some later time, be an occasion where the functionality and/or accuracy of the new job flow and/or the neural network may be deemed to be in need of an evaluation. On such an occasion, as an aid to ensuring accountability for the development of the new job flow and/or the neural network, it may be deemed desirable to provide an indication of what earlier job flow(s) and/or data object(s) were employed in training and/or in testing the new job flow and/or the neural network.

[0534] FIG. **16J** provides a view of aspects of an example job flow **2200jk** that employs neuromorphic processing (i.e., employs one or more neural networks), an example job flow definition **2220jk** that defines the job flow **2200jk**, an example performance **2700ajk** of the job flow **2200jk**, and a corresponding example instance log **2720ajk** that documents an instance of the performance **2700ajk**. This view is similar to the view provided by FIG. **16A** of aspects of the earlier discussed example job flow **2200fgh** that does not employ neuromorphic processing (i.e., employs no neural networks), the job flow definition **2220fgh** that defines the job flow **2200fgh**, the example performance **2700afg2h** of the job flow **2200fgh**, and the example instance log **2720afg2h** that documents one instance of the performance **2700afg2h**. As depicted in FIG. **16J**, the job flow definition **2220jk** may

be defined to include a first task able to be performed by a task routine **2440j** that entails the use of neural configuration data **2371j**, and a second task able to be performed by a task routine **2440k**. The task performable by the task routine **2440j** may be that of using the neural network configuration data **2371j** to instantiate a one or more neural networks (not specifically shown), and the task performable by the task routine **2440k** may be that of using those one or more neural networks to cause the job flow **2200jk** to perform the same function as the job flow **2200fgh**.

[0535] The neural network configuration data **2371j** may define hyperparameters and/or trained parameters that define at least one neural network employed in the job flow **2200jk** after the at least one neural network has been trained. By way of example, the neural network configuration data **2371j** may define hyperparameters and/or trained parameters for each neural network in an ensemble of neural networks (e.g., a chain of neural networks). Regardless of how many neural networks are associated with the neural network configuration data **2371j**, the neural network configuration data **2371j** may be deemed and/or handled as an integral part of the depicted example task routine **2440j** for purposes of storage among one or more federated areas **2566**. In such embodiments, the executable instructions **2447** of the task routine **2440j** may include some form of link (e.g., a pointer, identifier, etc.) that refers to the neural network configuration data **2371j** as part of a mechanism to cause the retrieval and/or use of the neural network configuration data **2371j** alongside the task routine **2440j**. Alternatively, in such embodiments, the task routine **2440j** may wholly integrate the neural network configuration data **2371j** as a form of directly embedded data structure.

[0536] However, in other embodiments, the neural network configuration data **2371j** may be incorporated into and/or be otherwise treated as a mid-flow data set **2370j** that may be stored among multiple data sets **2330** and/or **2370** within one or more federated areas **2566**, including being subject to at least a subset of the same rules controlling access thereto as are applied to any other data set **2330** and/or **2370**. In such other embodiments, the same techniques normally employed in selecting and/or specifying a data set **2330** or **2370** as an input to a task routine **2440** in a performance of a job flow **2200** may be used to specify the neural network configuration data **2371j** as the mid-flow data set **2370j** serving as an input to the task routine **2440j**. In this way, the at least one neural network defined by the configuration data **2371j** may be given at least some degree of protection against deletion, may be made available for use in multiple different job flow flows (including other job flows that may perform further training of that at least one neural network that yield improved versions that may also be so stored), and/or may be documented within one or more instance logs as having been employed in one or more corresponding performances of job flows **2200**.

[0537] It should be noted that, although the neural network configuration data **2371j** is depicted and discussed herein as being designated and treated as the depicted mid-flow data set **2370j**, this is in recognition of the possibility that, within a job flow **2200**, one task routine **2440** may generate, in a training process, the neural network configuration data **2371j** as a mid-flow data set **2370j** for use by another task routine **2440** within the same job flow **2200**. By way of example, a job flow **2200** may initially use the neural network configuration data **2371j** as is, but may then cease

that initial use and initiate a training mode in which the neural network configuration data **2371j** is modified as a result of further training in response to a condition such as a failure to meet a threshold of accuracy during that initial use. However, other embodiments are possible in which the neural network configuration data **2371j** is generated within one job flow **2200** for use by one or more other job flows **2200**, and/or is generated in an entirely different process that is not implemented as a job flow **2200** made up of multiple tasks that are performed by the execution of multiple task routines **2440**. Thus, other embodiments are possible in which the neural network configuration data **2371j** may be more appropriately regarded as having been generated as a result report **2770** in the performance of a job flow **2200** and/or may be more appropriately regarded as a flow input data set **2330** to a job flow **2200**.

[0538] It should also be noted that, although a single instance of neural network configuration data **2371** has been discussed as being treated as a data object (e.g., a data set **2330** or **2370**, or a result report **2770**), other embodiments are possible in which a single data object includes multiple instances of neural network configuration data **2371**. This may be deemed desirable as a mechanism to keep together the hyperparameters and/or the trained parameters of a set of multiple neural networks that are to be used together to perform a function, such as an ensemble of neural networks. More precisely, while it may be that each neural network of a set of multiple neural networks is trained separately and/or sequentially, it may be deemed necessary to ensure success in using those multiple neural networks together by keeping the neural network configuration data **2371** for each of those neural networks together. In this way, a situation in which the neural network configuration data **2371** for a subset of those neural networks is errantly deleted may be avoided, as well as avoiding a situation in which older and newer versions of the neural network configuration data **2371** for different ones of those multiple neural networks are errantly used together.

[0539] As also depicted in FIG. 16J, the job flow definition **2220jk** of the example job flow **2200jk** may include the job flow identifier **2221fgh** as a form of link to the job flow definition **2220fgh** that defines the example job flow **2200fgh**. Such a link to the job flow definition **2220fgh** may be provided in the job flow definition **2220jk** in a situation where one or more performances (i.e., the example performance **2700afg2h**) of the job flow **2200fgh** were used in training and/or in testing the at least one neural network of the job flow **2200jk**. Alternatively or additionally, the instance log **2720ajk** that documents aspects of an instance of the example performance **2700afk** of the example job flow **2200jk** may include the instance log identifier **2721afg2h** as a link to the instance log **2720afg2h** that documents an instance of the performance **2700afg2h**. Such a link to the instance log **2720afg2h** may be provided in the instance log **2720ajk** in a situation where an instance of the performance **2700afg2h** was used in training and/or in testing the at least one neural network of the job flow **2200jk**. Through the provision of such links, the fact that the job flow **2200fgh** and/or the specific performance **2700afg2h** was used in training and/or in testing the at least one neural network of the job flow **2200jk** may be readily revealed, if at a later date, the job flow definition **2220jk** and/or the instance log **2720ajk** are retrieved and analyzed as part of a later evaluation of the job flow **2200jk**. In this way, some

degree of accountability for how the at least one neural network of the job flow **2200***jk* was trained and/or tested may be ensured should such training and/or testing need to be scrutinized.

[0540] Referring to both FIGS. **16A** and **16J**, as depicted, either or both of the example job flow definitions **2220***fgh* or **2220***jk* may additionally include GUI instructions **2229***fgh* or **2229***jk*, respectively. As previously discussed, such GUI instructions **2229** incorporated into a job flow definition **2220** may provide instructions for execution by a processor to provide a job flow GUI during a performance of the corresponding job flow **2200**. As earlier discussed, a job flow definition **2220** may include flow task identifiers **2241** that identify the tasks to be performed, but not particular task routines **2440** to perform those tasks, as a mechanism to enable the most current versions of task routines **2440** to be used to perform the tasks. As also earlier discussed, a job flow definition **2220** may also define data interfaces **2223** in a way that specifies characteristics of the inputs and/or outputs for each task to be performed, but may not specify any particular data object **2330** as an approach to allowing data objects **2330** that are to be used as inputs to a performance to be specified at the time a performance is to begin. As processor(s) **2550** of federated device(s) **2500** are caused to execute instructions of task routines **2440** as part of performing a job flow **2200**, processor(s) **2550** of federate device(s) **2500** may also be caused, by execution of instructions of an interaction component **2548** of the control routine **2540**, to execute the GUI instructions **2229** within the corresponding job flow definition **2220** to provide a job flow GUI.

[0541] By way of example, through execution of GUI instructions **2229**, a job flow GUI may be provided that guides a user through an opportunity to specify one or more of the data objects **2330** that are to be used as inputs. Also by way of example, a job flow GUI may be provided to afford a user an opportunity to specify the use of one or more particular task routines **2440** as part of an effort to analyze the accuracy and/or other aspects of a performance of a job flow **2200**. Further by way of example, the GUI instructions **2229***jk*, when executed, may provide a user an opportunity to specify the mid-flow data set **2370***j* or another data object **2330**, **2370** or **2770** as the one that should be used to provide the neural network configuration data **2371***j* to be used to instantiate the at least one neural network to be used in a performance of the job flow **2200***jk*.

[0542] Turning to FIG. **16K**, as has been discussed, DAGs **2270** may be generated to provide visual representations of various objects, including to highlight various details thereof, such as error conditions preventing the storage and/or use of those objects. Again, such objects include task routines **2440**, job flow definitions **2220** and/or instance logs **2720**. As exemplified using the job flow definition **2220***fgh* and an associated DAG **2270***fgh*, processor(s) **2550** of federated device(s) may be caused by execution of the interaction component **2548** of the control routine **2540** to generate a DAG **2270** to provide a visual representation of a job flow described by a job flow definition **2220**. Such a DAG **2270** may be generated from that job flow definition **2220** to include most, if not all, of the same pieces of information concerning that job flow as are needed within that job flow definition **2220** to enable the job flow definition **2220** to be used in a performance of the job flow.

[0543] Thus, as depicted, the DAG **2270***fgh* may be generated to include the job flow identifier **2221***fgh*, the flow definition **2225** and the interface definitions **2224**, as does the job flow definition **2220***fgh*, although the DAG **2270***fgh* may not include the GUI instructions **2229***fgh* that may be included within the job flow definition **2220***fgh*. However, as also depicted, while the DAG **2270***fgh* may have much of the same content as the job flow definition **2220***fgh*, the formatting and/or syntax of that content may differ therebetween. More specifically, the fact that the job flow definition **2220***fgh* is meant to be used in the performance of the job flow that it describes may lead to at least the interface definitions **2224** being written in a selected programming language (e.g., the SAS programming language), and may additionally lead to the job flow identifier **2221***fgh* and/or the flow definition **2225** being written to at least conform to the syntax used for comments in the same selected programming language. Also, the fact that the DAG **2270***fgh* is meant to be used to provide a visual representation of a job flow **2200** may lead to one or more of the job flow identifier **2221***fgh*, the flow definition **2225** and the interface definitions **2224** being written in a selected form of notation for the description of processes (e.g., BPMN). However, it should be noted that other embodiments are possible in which the job flow definition **2220***fgh* and the DAG **2270***fgh* are written using the same language and syntax such that the job flow definition **2220***fgh* and the DAG **2270***fgh* may be directly interchangeable (although the DAG **2270***fgh* may be generated to include a subset of the contents of the job flow definition **2220***fgh*, such that it may not include such items as the GUI instructions **2229***fgh*). Indeed, in some of such embodiments, it may be that the job flow definition **2220***fgh* and the DAG **2270***fgh* are one and the same object as stored within a federated area **2566**.

[0544] Regardless of whether the contents of job flow definitions **2220** and their corresponding DAGs **2270** are written in the same language, the fact that DAGs **2270** generated to provide visual representations of job flow definitions **2220** include many (if not all) of the same pieces of information may enable job flow definitions **2220** to be generated from such DAGs **2270** just as easily as such DAGs **2270** may be directly generated from job flow definitions **2220**. As will be explained in greater detail, advantage may be taken of this interchangeability between job flow definitions **2220** and such DAGs **2270** to enable new job flow definitions **2220** that describe entirely new job flows to be generated graphically by personnel who entirely lack programming skills. More specifically, a new job flow definition **2220** may be created by personnel though use of a graphical editor in which such personnel graphically create a DAG **2270** that may also serve as the new job flow definition **2220** or from which the new job flow definition **2220** may be automatically generated. In some of such embodiments, it may be that such a graphical editor is used to combine at least portions of multiple preexisting job flows to form a new job flow (e.g., the previously discussed “superset” job flow) as a DAG **2270** from which a corresponding job flow definition **2220** may be automatically generated.

[0545] Turning to FIG. **16L**, in some embodiments, the interface definitions **2224** within the job flow definition **2220***fgh* may be derived as part of the generation of the DAG **2270***fgh* based on comments **2448** about the interfaces **2443/2444** and/or based on portions of the executable

instructions **2447** that implement the interfaces **2443/2444** within the task routines **2440f**, **2440g2** and **2440h**. More specifically, it may be that the job flow definition **2220/gh** is at least partially generated from a parsing of comments **2448** and/or of portions of the executable instructions **2447** descriptive of the input and/or output interfaces **2443** and/or **2444** of one or more task routines **2440** that perform the functions of the job flow **2200/gh** that the job flow definition **2220/gh** is to define.

[0546] In some embodiments, and as depicted, information concerning interfaces **2443** and/or **2444** implemented within each of the task routines **2440f**, **2440g2** and **2440h** may be stored, at least temporarily, as macros **2470f**, **2470g2** and **2470h**, respectively, although it should be noted that other forms of intermediate data structure may be used in providing intermediate storage of information concerning inputs and/or outputs. In some embodiments, this may be done to enable the transmission of information needed to generate the DAG **2270/gh** in a more compact form to another device. With all of such data structures having been generated, the information within each that concerns interfaces **2443** and/or **2444** may then be used to generate the DAG **2270/gh** to include the interface definitions **2224**. And it may be that, from the interface definitions **2224**, at least a portion of the flow definition **2225** is able to be derived.

[0547] FIGS. **17A**, **17B**, **17C**, **17D**, **17E** and **17F**, together, illustrate the manner in which the one or more federated devices **2500** may selectively store and organize objects within one or more federated areas **2566**. FIGS. **17A-C**, together, illustrate aspects of the selective translation or conversion, of objects received from one or more source devices **2100**, or from one or more reviewing devices **2800**, as well as storage of those objects within the one or more federated areas **2566**. FIGS. **17D-F**, together, illustrate aspects of assigning identifiers to objects stored within the one or more federated areas **2566**.

[0548] Turning to FIG. **17A**, as previously discussed, the one or more federated devices **2500** may receive objects (e.g., job flow definitions **2220**, DAGs **2270**, flow input data sets **2330**, mid-flow data sets **2370**, task routines **2440**, macros **2470**, instance logs **2720** and/or result reports **2770**) from other devices **2100** and/or **2800** as part of an exchange of objects in response to a request to perform any of a variety of operations. Again, in executing the portal component **2549**, the processor(s) **2550** of the one or more federated devices **2500** may be caused to operate one or more of the network interfaces **2590** to provide a portal accessible by other devices via the network **2999**, and through which access may be granted by the processor(s) **2550** to the one or more federated areas **2566**. Also again, any of a variety of network and/or other protocols may be used. Such requests may include requests to store one or more objects transmitted therewith and/or for which pointer(s) may be transmitted therewith; and/or requests to perform one or more job flows and/or one or more individually specified tasks using one or more objects transmitted therewith and/or for which pointer(s) may be transmitted therewith.

[0549] Alternatively, and as also previously discussed, the one or more federated devices **2500** may receive objects as a result of an ongoing synchronization relationship instantiated between one or more transfer areas **2666** within one or more federated areas **2566** and one or more other transfer areas **2166** or **2866** within a storage **2160** or **2860**, respectively. For each such transfer area **2666**, the processor(s)

2550 of the one or more federated devices **2500** may be caused by the federated area component **2546** to refer to the federated area parameters **2536** for parameters in instantiating the transfer area **2666** within a federated area **2566**, such as minimum and/or maximum size of the transfer area **2666** and/or minimum or maximum percentage of the space within a federated area **2566** that is to be occupied by the transfer area **2666**. Other parameters that may be retrieved from the federated area parameters **2536** may be specifications of one or more types of cooperation that may be used with the other device **2100** or **2800** with which a synchronization relationship is instantiated, such as whether the earlier described polling or volunteering approaches are to be used, and/or at what minimum and/or maximum interval of time is to be allowed to elapse between each instance of exchange of status of objects within transfer areas. Other parameters that may be so retrieved may include specifications of a minimum or maximum quantity of objects to be exchanged when a transfer between transfer areas occurs.

[0550] Still another parameter concerning exchanges of objects between a transfer area **2666** within a federated area **2566** and a transfer area **2166** or **2866** within a storage **2160** or **2860**, respectively, that may be retrieved from the federated area parameters **2536** may be a specification for what minimum conditions must be met for such an automated transfer of objects to be triggered. In some embodiments, the trigger may be one or more of a minimum degree of change in an object (e.g., a minimum percent change in size of a data object or a minimum extent of change in executable instructions of a task routine **2440**), and/or a minimum number of objects that must be involved in a change in status. Alternatively or additionally, in other embodiments, the trigger for such an automated transfer may be a maximum amount of time to allow to elapse until the next exchange of object(s) since the detection of a change in status of any object.

[0551] Alternatively or additionally, and by way of example in still other embodiments, the trigger may be associated with occurrences of objects being “checked in” and/or “committed” in a formalized source code management system. More specifically, and as will be familiar to those skilled in the art, where multiple developers are collaborating to develop programming code for an analysis or other type of executable program, a source code management system may be put into place to improve coordination thereamong. Such a source code management system may enforce some degree of control over which developer and/or how many developers may be work with each one of different portions of executable instructions at the same time as a proactive measure to avoid having different developers making conflicting changes to the same portion of executable instructions. A developer may be required to “check out” a portion of executable instructions from the source control management system to be allowed to make changes thereto, and this may serve to cause other developers to be prevented from also checking out that same portion until the developer to which that portion is check out subsequently “checks in” that same portion. Alternatively or additionally, such a source code management system may track the changes made to different portions of executable instructions by different developers as a way to provide the ability to roll back changes made by any one developer to a portion of executable instructions that is found to “break” the ability to compile and/or interpret the executable instructions of the analysis or other routine. There may be a compiling of the

executable instructions of the analysis or other routine on a recurring interval of time which may be used as a mechanism to identify changed portions of executable instructions that at least do not break the compiling of the full set of executable instructions such that they are deemed acceptable to remain as part of the full set of executable instructions such that those changes are deemed to be “committed” changes to the full set of executable instructions.

[0552] It may be that a portion of the storage 2160 of a source device 2100 or a portion the storage 2860 of a reviewing device 2800 is employed as the storage at which a source code management system maintains a copy of all of the executable instructions of an analysis routine or other routine under development by multiple developers who do not use the one or more federated area(s) 2566 maintained by the one or more federated devices 2500. Such developers may not have been granted access to a federated area 2566 and/or they may not be familiar with the use of federated areas 2566. Meanwhile, there may also be other developers also involved in developing the same analysis or other routine who do have access to and/or are familiar with the one or more federated areas 2566 maintained by the one or more federated devices 2500. Such other developers may at least partly rely on the enforcement of rules for the storage of objects in federated areas 2566 as a mechanism to similarly instill a degree of order in their collaboration among themselves in developing portions of the analysis or other routine. Thus, in this example embodiment, there may be two different sets of developers collaborating on the development of the same analysis or other routine who are using two separate systems of source code management to aid in coordinating their efforts.

[0553] As part of enabling collaboration between these two different groups of developers, as well as their differing systems of source code management, the portion of the storage 2160 or 2860 of the device 2100 or 2800 within which the source code management system maintains a copy of all of the executable instructions may be additionally designated as one or more transfer areas 2166 or 2866, respectively. Correspondingly, at least a portion of one or more federated areas 2566 that have been designated as the location in which portions of the executable instructions of the analysis or other routine may also be stored may each be similarly designated as a transfer area 2666, and a synchronization relationship may be instantiated between each such transfer area 2666 and a counterpart other transfer area 2166 or 2866. With these transfer areas and their synchronization relationship(s) having been instantiated, it may be that the processor(s) 2550 of the one or more federated devices 2500 are caused to cooperate with the processor(s) 2150 of the device 2100 in which the transfer area(s) 2166 are instantiated, or the processor(s) of the device 2800 in which the transfer area(s) 2866 are instantiated, to use instances in which changes to portions of executable instructions have been “committed” or at least “checked in” as a trigger to cause the transfer of the affected object(s) (e.g., job flow definitions 2220 and/or task routines 2440 that contain the changed executable instructions) between a transfer area 2666 and a corresponding other transfer area 2166 or 2866, respectively. In this way, collaboration among these two different groups of developers may be enabled through collaboration between the systems that each relies upon to coordinate their development efforts in this example embodiment.

[0554] As also previously discussed, the processor(s) 2550 of the one or more federated devices 2500 may selectively allow or disallow each received request (including a requests to instantiate a synchronization relationship) based on determinations of whether each of those requests is authorized. Again, and more precisely, the processor(s) 2550 of the one or more federated devices 2500 may be caused by the portal component 2549 to restrict what persons, devices and/or entities are to be given access to one or more federated areas 2566. It should be noted that, in alternate embodiments, such control over whether access is granted may be exerted by another device (not shown) that may be interposed between the one or more federated devices 2500 and the network 2999 to serve as a gateway that controls access to the one or more federated devices 2500, and thereby, controls access to the one or more federated areas.

[0555] Beyond selective granting of access to the one or more federated areas 2566 (in embodiments in which the one or more federated devices 2500 control access thereto), the processor(s) 2550 may be further caused by execution of the portal component 2549 to restrict the types of access granted, depending on the identity of the user to which access has been granted. Again, the portal data 2539 may indicate that different persons and/or different devices associated with a particular scholastic, governmental or business entity are each to be allowed different degrees and/or different types of access. One such person or device may be granted access to retrieve objects from within a federated area 2566, but may not be granted access to alter or delete objects, while another particular person operating a particular device may be granted a greater degree of access that allows such actions. In embodiments in which there is a per-object control of access, the one or more federated devices 2500 (or the one or more other devices that separately control access) may cooperate with the one or more storage devices 2600 (if present) to effect such per-object access control.

[0556] Regardless of the exact manner in which objects may be received by the one or more federated devices from other devices, and as also previously discussed, the processor(s) 2550 of the one or more federated devices 2500 may be caused by the admission component 2542 to impose various restrictions on what objects may be stored within a federated area 2566, presuming that the processor(s) 2550 have been caused by the portal component 2549 to grant access in response to the received request to store objects. Some of such restrictions may be based on dependencies between objects and may advantageously automate the prevention of situations in which one object stored in a federated area 2566 is rendered nonfunctional as a result of another object having not been stored within the same federated area 2566 or within a federated area 2566 that is related through an inheritance relationship such that it is unavailable.

[0557] By way of example, and as previously explained, such objects as job flow definitions 2220 include references to tasks to be performed. In some embodiments, it may be deemed desirable to prevent a situation in which there is a job flow definition 2220 stored within a federated area 2566 that describes a job flow that cannot be performed as a result of there being no task routines 2440 stored within the same federated area 2566 and/or within a related federated area 2566 that are able to perform one or more of the tasks specified in the job flow definition 2220. Thus, where a

request is received to store a job flow definition 2220, the processor(s) 2550 may be caused by the admission component 2542 to first determine whether there is at least one task routine 2440 stored within the same federated area 2566 and/or within a related federated area 2566 to perform each task specified in the job flow definition. If there isn't, then the processor(s) 2550 may be caused by the admission component 2542 to disallow storage of that job flow definition 2220 within that federated area 2566, at least until such missing task routine(s) 2440 have been stored therein and/or within a related federated area 2566 from which they would be accessible through an inheritance relationship. In so doing, and as an approach to improving ease of use, the processor(s) 2550 may be caused to transmit an indication of the reason for the refusal to inform an operator of the source device 2100 of what can be done to remedy the situation.

[0558] Also by way of example, and as previously explained, such objects as instance logs 2720 include references to such other objects as a job flow definition, task routines executed to perform tasks, and data objects employed as inputs and/or generated as outputs. In some embodiments, it may also be deemed desirable to avoid a situation in which there is an instance log 2720 stored within a federated area 2566 that describes a performance of a job flow that cannot be repeated as a result of the job flow definition 2220, one of the task routines 2440, or one of the data objects referred to in the instance log 2720 not being stored within the same federated area 2566 and/or within a related federated area 2566 from which they would also be accessible. Such a situation may entirely prevent a review of a performance of a job flow. Thus, where a request is received to store an instance log 2720, the processor(s) 2550 of the one or more federated devices 2500 may be caused by the admission component 2542 to first determine whether all of the objects referred to in the instance log 2720 are stored within the same federated area 2566 and/or a related federated area 2566 in which they would also be accessible, thereby enabling a repeat performance using all of the objects referred to in the instance log 2720. If there isn't then the processor(s) 2550 may be caused by the admission component 2542 to disallow storage of that instance log 2720 within that federated area 2566, at least until such missing object(s) have been stored therein and/or within a related federated area 2566. Again, as an approach to improving ease of use, the processor(s) 2550 may be caused to transmit an indication of the reason for the refusal to inform an operator of the source device 2100 of what can be done to remedy the situation, including identifying the missing objects.

[0559] Additionally by way of example, and as previously explained, such objects as job flow definitions 2220 may specify various aspects of interfaces among task routines, and/or between task routines and data objects. In some embodiments, it may be deemed desirable to prevent a situation in which the specification in a job flow definition 2220 of an interface for any task routine that may be selected to perform a specific task does not match the manner in which that interface is implemented in a task routine 2440 that may be selected for execution to perform that task. Thus, where a request is received to store a combination of objects that includes both a job flow definition 2220 and one or more associated task routines 2440, the processor(s) 2550 may be caused to compare the specifications of interfaces within the job flow definition 2220 to the implementations of

those interfaces within the associated task routines 2440 to determine whether they sufficiently match. Alternatively or additionally, the processor(s) 2550 may be caused to perform such comparisons between the job flow definition 2220 that is requested to be stored and one or more task routines 2440 already stored within one or more federated areas 2566, and/or to perform such comparisons between each of the task routines 2440 that are requested to be stored and one or more job flow definitions 2220 already stored within one or more federated areas 2566. If the processor(s) 2550 determine that there is an insufficient match, then the processor(s) 2550 may be caused to disallow storage of the job flow definition 2220 and/or of the one or more associated task routines 2440. In so doing, and as an approach to improving ease of use, the processor(s) 2550 may be caused to transmit an indication of the reason for the refusal to inform an operator of the source device 2100 of what can be done to remedy the situation, including providing details of the insufficiency of the match.

[0560] As previously discussed, macros 2470 and DAGs 2270 may be generated from information concerning the inputs and/or outputs of one or more task routines 2440 such that, like a job flow definition 2200 and/or an instance log 2720, each macro 2470 and each DAG 2270 is associated with one or more task routines 2440. As a result of such associations, it may be deemed desirable to ensure that further analysis of the information within each macro 2470 and/or DAG 2270 is enabled by requiring that the one or more task routines 2440 from which each is derived be available within a federated area 2566 to be accessed. More specifically, in executing the admission component 2542, the processor(s) 2550 of the one or more federated devices 2500 may be caused to impose restrictions on the storage of macros 2470 and/or DAGs 2270 that may be similar to those just discussed for the storage of job flow definitions 2200 and/or instance logs 2720. Thus, in response to a request to store one or more macros 2470 and/or one or more DAGs 2270, the processor(s) 2550 may first be caused to determine whether the task routine(s) 2440 on which the information concerning inputs and/or outputs within each macro 2470 and/or within each DAG 2270 may be based is stored within a federated area 2566 or is provided for storage along with each 2470 and/or each DAG 2270 for storage. Storage of a macro 2470 or of a DAG 2270 may be refused if such associated task routine(s) 2440 are not already so stored and are also not provided along with the macro 2470 or DAG 2270 that is requested to be stored.

[0561] Regardless of the exact manner in which a transfer of objects between devices and through the network 2999 is caused to occur, it should be noted that, depending on whether grids or other groups of devices are on either end of the transfer, some degree of parallelism may be employed in carrying out the transfer. More specifically, at least where an object is being transferred to or transferred from multiple ones of the federated devices 2500 (e.g., a grid 2005 of the federated devices 2500) as a result of a federated area 2566 being maintained in a distributed manner by multiple federated devices 2500, the transfer of the single object may be broken up into separate and at least partially parallel transfers of different portions of the object to or from the multiple federated devices 2500. This may be deemed desirable for the transfer of larger objects, such as data objects (e.g., an flow input data set 2330 or a result report 2770) that may be quite large in size. Further, in embodiments in which grids

of devices are involved in both ends of a transfer of an object, it may be that the transfer is performed as multiple transfers of portions of the object in which each such portion is transferred between a different pair of devices. More precisely and by way of example, where a source device **2100** that transmitted a request to store an object in a federated area **2566** is operated as part of a grid of the source devices **2100**, the granting of access to store an object in the federated area **2566** may result in each of multiple source devices **2100** transmitting a different portion of the object to a different one of multiple federated devices **2500** in at least partially parallel transfers.

[0562] Turning to FIG. 17B, regardless of the exact manner in which the one or more federated devices **2500** are caused to receive objects, and as previously discussed, it may be that some received objects include portions that are written in one or more secondary programming languages, instead of in the primary programming language normally utilized by the processor(s) **2550** during a performance of a job flow. More specifically, among the received objects may be task routines **2440** in which at least executable instructions for the performance of a task may be written in a secondary programming language, and/or job flow definitions **2220** in which at least portion(s) thereof that define input and/or output interfaces may be written in a secondary programming language. As has been previously discussed, task routines **2440** that include such portions written in a secondary programming language may be stored unchanged within federated area(s), and their executable instructions may later be interpreted and/or compiled by an appropriate runtime interpreter or compiler at the time of their execution.

[0563] However, and as also previously discussed, where a job flow definition **2220s** is received that includes at least input and/or output interface definitions written in a secondary programming language, it may be deemed desirable to generate a translated form **2220p** thereof in which those definitions are written in the primary programming language, and to store that translated form **2220p** within a federated area in lieu of the originally received form **2220s**. Again, this may be done to provide developers who are familiar with the primary programming language with a form of the job flow definition **2220s** that is written in the primary programming language to improved the ease with which they are able to read and/or edit the job flow that is defined therein.

[0564] As previously discussed, in some embodiments, as part of performing various comparisons of definitions for and/or implementations of input and/or output interfaces, the processor(s) **2550** of the one or more federated devices **2500** may be caused by the admission component **2542** to translate each portion of each job flow definition **2220** that defines input and/or output interfaces, and each portion of executable instructions of each task routine that implements input and/or output interfaces, into an intermediate representation, such as an intermediate programming language or a data structure. Thus, upon receipt of the depicted job flow definition **2220s**, the portion(s) thereof that define input and/or output interfaces using a secondary programming language may already be translated into an intermediate representation for purposes of making such comparisons. In such embodiments, the processor(s) may be further caused by the interpretation component **2547** to further translate that intermediate representation into the primary programming language as part of generating the corresponding input

and/or output interface definitions for the job flow definition **2220p** that is generated as the translated form of the originally received job flow definition **2220s**.

[0565] As previously discussed, job flow definitions **2220** may be derived from DAGs **2270** and/or vice versa. As also previously discussed, embodiments are possible in which different DAGs **2270** may be generated in different languages, and such different languages may be the same differing programming languages as used in portions of job flow definitions **2220**, or such different languages may be differing forms of notation (e.g., BPMN versus other forms of notation) that may each be associated with a different programming language and/or a different development environment. Thus, like job flow definitions **2220**, it may be that DAGs **2270** exchanged between the one or more federated devices **2500** and another device **2100** or **2800** may also be at least partially translated such that, as depicted, for a DAG **2270s** stored within a transfer area **2166** or **2866** within a storage **2160** or **2860**, respectively, that employs a secondary programming language or secondary form of notation, there may be a corresponding DAG **2270p** stored within a transfer area **2666** within a federated area **2566** that employs a primary programming language or primary form of notation to provide the same view of the same job flow **2200**, of the same instance of performance of a job flow **2200**, of the same task and/or of the same task routine **2440**.

[0566] The processor(s) **2550** of the one or more federated devices **2500** may be caused by the interpretation component **2547** to retrieve various rules and/or other parameters for the performance of translations between programming language(s) from the interpretation rules **2537**. Among such rules and/or parameters may be a data structure providing a cross-reference of items of vocabulary between the primary programming language and each of one or more secondary programming languages, and/or a data structure providing a cross-reference of items of syntax therebetween (e.g., punctuation, use of spacing, ordering of commands and/or data, etc.). Alternatively or additionally, among such rules and/or parameters may be a specification of the manner in which the organization of data within data objects that is to be used in either defining input and/or output interfaces in job flow definitions or implementing input and/or output interfaces in task routines.

[0567] Turning to FIG. 17C, also regardless of the exact manner in which the one or more federated devices **2500** are caused to receive objects, and as also previously discussed, it may be that a received data object, such as the depicted example flow input data set **2330**, is of a size that is sufficiently large that it may not be possible (or at least, may be deemed prohibitively difficult) to store all of it within a single storage device **2600** as an undivided object. Again, where such a data object is of such large size, it may be divided into multiple data object blocks as part of storing it in a distributed manner across multiple storage devices **2600a-x** within a federated area **2566** that spans storage spaces provided by the multiple storage devices **2600a-x** within a distributed file system **2664** implemented by at least the multiple storage devices **2600a-x**. Again, in some embodiments, still another storage device **2600z** may be employed to coordinate the maintenance of the distributed file system **2664**, as well as to coordinate the use of the storage space encompassed by the distributed file system **2664** with the one or more federated devices **2500**.

[0568] As previously discussed, the processor(s) **2550** of the one or more federated devices **2500** may be caused by the admission component **2542** to compare the size of the flow input data set **2330** to a predetermined threshold size as part of determining whether the flow input data set is large enough to be divided into multiple blocks for storage. If not, then the processor(s) **2550** may be caused simply to cooperate with one of the storage devices **2600a-x** to store the flow input data set **2330** therein as an undivided object therein.

[0569] However, if the flow input data set **2330** is larger than the predetermined threshold size, then the processor(s) **2550** of the one or more federated devices **2500** may analyze the flow input data set **2330** to determine whether it is in a distributable form in which it does not include a distinct metadata structure (e.g., the depicted metadata **2338**), in which the data items are organized in a homogeneous manner throughout (e.g., a single two-dimensional array), and/or in which the homogeneous organization of the data items is of one of a preselected set of types of homogeneous organization. If flow input data set **2330** is determined to already be in distributable form (such that the depicted distributable form **2330d** and the originally received form **2330** are one and the same), then the processor(s) **2550** may be caused simply to cooperate with the storage devices **2600a-x** and/or **2600z** to store the flow input data set **2330**, as received, as the distributable form **2330d** in a distributed manner in which the storage devices **2600a-x** and/or **2600z** divide the flow input data set **2330** into the depicted multiple data object blocks **2336d** that are distributed thereamong for storage.

[0570] However, if the flow input data set **2330** is both larger than the predetermined threshold size and not in distributable form, then the processor(s) **2550** may be caused by execution of the admission component **2542** and/or the interpretation component **2547** to convert the flow input data set **2330** from its originally received form and into the flow input data set **2330d** of distributable form. In so doing, the processor(s) **2550** may be caused to refer to the interpretation rules **2537** for rules concerning the interpretation of any metadata that may be present within the flow input data set **2330** in its original form, and/or for rules concerning conversions from the manner in which the data items may be organized in the original form and into a homogeneous manner of organization of the data items in the distributable form (e.g., a conversion between differing data structures, such as arrays, linked lists, comma-separated values, etc.). With the flow input data set **2330** so converted into the distributable form **2330d**, the processor(s) **2550** may then be caused to cooperate with the storage devices **2600a-x** and/or **2600z** to store the flow input data set **2330d** of distributable form in a distributed manner among the storage devices **2600a-x**.

[0571] Turning to FIG. 17D, as depicted, the control routine **2540** may include an identifier component **2541** to cause the processor(s) **2550** of the one or more federated devices **2500** to assign identifiers to objects stored within the one or more federated areas **2566**. As previously discussed, each instance log **2720** may refer to objects associated with a performance of a job flow (e.g., a job flow definition **2220**, task routines **2440**, and/or data objects used as inputs and/or generated as outputs, such as the data sets **2330** and/or **2370**, and/or a result report **2770**) by identifiers assigned to each. Also, as will shortly be explained, the assigned identifiers

may be employed as part of an indexing system in one or more data structures and/or databases to more efficiently retrieve such objects. In some embodiments, the processor (s) **2550** of the one or more federated devices **2500** may be caused by the identifier component **2541** to assign identifiers to objects as they are received via the network **2999** from other devices, such as the one or more source devices **2100** and/or the one or more reviewing devices **2800**. In other embodiments, the processor(s) **2550** may be caused by the identifier component **2541** to assign identifiers to objects generated as a result of a performance of a job flow (e.g., a mid-flow data set **2370** or a result report **2770** generated as an output data object of a task routine).

[0572] In some embodiments, an object identifier may be generated by taking a hash of at least a portion of its associated object to generate a hash value that becomes the identifier. More specifically, a job flow identifier **2221** may be generated by taking a hash of at least a portion of the corresponding job flow definition **2220**; a data object identifier **2331** may be generated by taking a hash of at least a portion of the corresponding data set **2330** or **2370**; a task routine identifier **2441** may be generated by taking a hash of at least a portion of the corresponding task routine **2440**; and/or a result report identifier **2771** may be generated by taking a hash of at least a portion of the corresponding result report **2770**. Any of a variety of hash algorithms familiar to those skilled in the art may be employed. Such an approach to generating identifiers may be deemed desirable as it may provide a relatively simple mechanism to generate identifiers that are highly likely to be unique to each object, presuming that a large enough portion of each object is used as the basis for each hash taken and/or each of the identifiers is of a large enough bit width. In some embodiments, the size of the portions of each of these different objects of which a hash is taken may be identical. Alternatively or additionally, the bit widths of the resulting hash values that become the identifiers **2221**, **2331**, **2441** and **2771** may be identical.

[0573] Such an approach to generating object identifiers **2221**, **2331**, **2441** and/or **2771** may advantageously be easily implemented by devices other than the one or more federated devices **2500** to reliably generate identifiers for objects that are identical to the identifiers generated by the processor (s) **2550** of any of the one or more federated devices **2500**. Thus, if a job flow is performed by another device, the instance log **2720** generated by the other device would use identifiers to refer to the objects associated with that performance that would be identical to the identifiers that would have been generated by the processor(s) **2550** of the one or more federated devices **2500** to refer to those same objects. As a result, such an instance log **2720** could be received by the one or more federated devices **2500** and stored within a federated area **2566** without the need to derive new identifiers to replace those already included within that instance log **2720** to refer to objects associated with a performance of a job flow.

[0574] Referring to FIG. 17A in addition to FIG. 17D, in some embodiments, the identifier component **2541** may cooperate with the admission component **2542** in causing the processor(s) **2550** of the one or more federated devices **2500** to analyze received objects to determine compliance with various restrictions as part of determining whether to allow those objects to be stored within the one or more federated areas **2566**. More specifically, and by way of

example, the identifier component **2541** may generate object identifiers for each received object. The provision of object identifiers for each received object may enable the admission component **2542** to cause the processor(s) **2550** to check whether the objects specified in a received instance log **2720** are available among the other objects received along with the received instance log **2720**, as well as whether the objects specified in the received instance log **2720** are available as already stored within one or more of the federated areas **2566**. If an object referred to in the received instance log **2720** is neither among the other objects received therewith or among the objects already stored within one or more of the federated area **2566**, then the processor(s) **2550** may be caused by the admission component **2542** to disallow storage of the received instance log **2720** within the one or more federated areas **2566**. As previously discussed, disallowing the storage of an instance log **2720** for such reasons may be deemed desirable to prevent storage of an instance log **2720** that describes a performance of a job flow that cannot be repeated due to one or more of the objects associated with that performance being missing.

[0575] Turning to FIG. 17E, in some embodiments, the generation of identifiers for instance logs **2720** may differ from the generation of identifiers for other objects. More specifically, while the identifiers **2221**, **2331**, **2441** and **2771** may each be derived by taking a hash of at least a portion of its corresponding object, an instance log identifier **2721** for an instance log **2720** may be derived from at least a portion of each of the identifiers for the objects that are associated with the instance of performance that an instance log **2720** serves to document. Thus, as depicted, the processor(s) **2550** of the one or more federated devices **2500** may be caused by the identifier component **2541** to generate an instance log identifier **2721** for an instance of a performance of a job flow **2200** by concatenating at least a portion of a job flow identifier **2221** for the job flow definition **2220** for the job flow **2200**; one or more data object identifiers **2331** for the flow input data set(s) **2330** and/or mid-flow data set(s) **2370** that were used as inputs and/or were generated; one or more task routine identifiers **2441** for the task routine(s) **2440** that were executed; one or more result report identifiers **2771** for the result report(s) **2770** that were generated; and/or the job flow instance identifier **2701** that uniquely identifies the instance of the performance of the job flow **2200**. In embodiments in which the bit widths of each of the identifiers **2221**, **2331**, **2441**, **2771** and **2701** are identical, log identifiers **2721** may be formed from identically sized portions of each of such identifiers **2221**, **2331**, **2441**, **2771** and/or **2701**, regardless of the quantity of each of the identifiers **2221**, **2331**, **2441**, **2771** and/or **2701** that are used. Such use of identically sized portions of such identifiers **2221**, **2331**, **2441**, **2771** and/or **2701** may be deemed desirable to aid in limiting the overall bit widths of the resulting log identifiers **2721**.

[0576] FIG. 17F illustrates such a concatenation of identifiers in greater detail using identifiers of objects associated with the example job flow **2200/gh** and the example performance **2700/afg2h** earlier discussed in connection with FIGS. 16A-D. As depicted, after having generated a job flow identifier **2221/gh**, a data set identifier **2331a**, a task routine identifier **2441f**, a task routine identifier **2441g2**, a task routine identifier **2441h** and a result report identifier **2771/afg2h** for the example job flow definition **2220/gh**, the data set **2330a**, the task routine **2440f**, the task routine

2440g2, the task routine **2440h** and the result report **2770/afg2h**, respectively, the processor(s) **2550** may be caused by the identifier component **2541** to concatenate at least an identically sized portion of each of these identifiers together to form the single instance log identifier **2721/afg2h** for the example instance log **2720/afg2h** of FIGS. 16A-D. As also depicted, in some embodiments, the job flow instance identifier **2701** that uniquely identifies the particular instance of the performance **2700/afg2h** (and that may also be caused to be generated by the identifier component **2541**) may also be included in such a concatenation to form the instance log identifier **271/afg2h**.

[0577] Referring back to FIGS. 17D-E, an object location identifier **2222**, **2332**, **2442**, **2722** or **2772** may be also be generated along with an object identifiers **2221**, **2331**, **2441**, **2721** or **2771**, respectively, for at least each object that is stored within a federated area **2566**. While the object identifiers **2221**, **2331**, **2441**, **2721** and **2771** may serve to uniquely identify each object, the object location identifiers **2222**, **2332**, **2442**, **2722** and **2772** may serve to identify where each object is stored in the storage space(s) provided by the one or more federated devices **2500** and/or by the one or more storage devices **2600**. In some embodiments, each of the object location identifiers **2222**, **2332**, **2442**, **2722** and **2772** may provide just an indication of what federated area **2566** an associated object is stored within, and an entirely separate mechanism may be employed to provide an indication of which one(s) of the one or more federated device(s) **2500** and/or which one(s) of the one or more storage device(s) **2600** provide storage space that is occupied by at least a portion of that federated area **2566**.

[0578] However, in other embodiments, each of the object location identifiers **2222**, **2332**, **2442**, **2722** and **2772** may directly provide both an indication of what federated area **2566** an associated object is stored within, and an indication of which one(s) of the one or more federated device(s) **2500** and/or which one(s) of the one or more storage device(s) **2600** provide storage space that is occupied by at least a portion of the associated object. It should be noted that, as previously discussed, even though a federated area **2566** may occupy storage spaces provided by multiple devices **2500** and/or **2600**, an object may be stored within that federated area **2566** in a manner in which it does not occupy all of those storage spaces provided by all of those multiple devices **2500** and/or **2600**. Therefore, the indication provided in each object location identifier **2222**, **2332**, **2442**, **2722** or **2772** of which device(s) **2500** and/or **2600** store at least a portion of the associated object may be a subset of the devices **2500** and/or **2600** that provide storage space for the federated area **2566** in which the associated object is stored.

[0579] Additionally, and as will be explained in greater detail, there may be various aspects of the manner in which an object may be stored as undivided object within the storage space provided by a single device **2500** or **2600**, and/or in a distributed manner across storage spaces provided by multiple devices **2500** and/or **2600**, and one or more of these aspects may affect the manner in which that object is able to be subsequently accessed. By way of example, and as previously discussed, the federated area **2566** in which an object is stored may be defined to exist within a storage space provided by just a single device **2500** or **2600**, but within either a local file system **2663** or a distributed file system **2664**, which may affect the manner in which the single device **2500** or **2600** is communicated with

as part of accessing that object. By way of another example, and as also previously discussed, the federated area **2566** in which an object is stored may be defined to exist such that it spans across storage spaces provided by multiple devices **2500** and/or **2600** within a distributed file system **2664**, but with the object being stored within that federated area **2566** as either an undivided object that occupies storage space within just a single one of those devices **2500** and/or **2600** or in a distributed manner that occupies storage space within some or all of those storage spaces, which may determine whether one or more of those devices **2500** and/or **2600** must be communicated with as part of accessing that object.

[**0580**] In some embodiments, to enable such aspects of the storage of an object to be taken into account, indications of such aspects may be included in its associated object location identifier **2222**, **2332**, **2442**, **2722** or **2772** for use in a subsequent retrieval of the object. Therefore, and referring back to FIGS. **17C-D** as an example, the conversion of the flow input data set **2330** into its distributable form **2330d** and the subsequent storage of the distributable form **2330d** as the multiple data object blocks **2336d**, as depicted in FIG. **17C**, may be followed by the storage, within one of the data object location identifiers **2332** depicted in FIG. **17D**, of indications of the flow input data set **2330** having been stored in a distributed manner as the multiple data object blocks **2336d** across multiple devices **2500a-x** or **2600a-x**, along with indications of which ones of the multiple devices **2500a-x** or **2600a-x** the multiple data object blocks **2336d** are stored within.

[**0581**] FIGS. **18A**, **18B**, **18C**, **18D**, **18E**, **18F** and **18G**, together, illustrate aspects of organizing objects within federated areas to better enable the retrieval of objects for use. FIG. **18A** depicts aspects of organizing objects into databases within federated areas **2566**. FIG. **18B** depicts aspects of a single global index that covers all federated areas **2566** within the example hierarchical tree earlier introduced in FIGS. **15B-C**, and FIG. **18C** depicts aspects of multiple side-by-side indexes for each private federated area **2566** within the same example hierarchical tree. FIG. **18D** illustrates aspects of selective retrieval of objects from one or more federated areas **2566** in response to requests received from one or more of the reviewing devices **2800**, and FIG. **18E** illustrates aspects of the use of identifiers assigned to objects to locate objects within one or more federated areas **2566** and/or to identify object associations. FIG. **18F** illustrates aspects of the retrieval of a job flow definition **2220** or a DAG **2270** in which a translation is performed between programming languages. FIG. **18G** illustrates aspects of the retrieval of a data object that has been stored in a distributed manner.

[**0582**] Turning to FIG. **18A**, as depicted, the control routine **2540** may include a database component **2545** to cause the processor(s) **2550** of the federated device(s) **2500** to organize various ones of the objects **2220**, **2270**, **2330**, **2370**, **2440**, **2470**, **2720** and **2770** into one or more databases **2562**, **2563**, **2564** and/or **2567** (or one or more of another type of data structure) for more efficient storage and retrieval thereof within the federated area(s) **2566**. In some embodiments in which there are multiple unrelated federated areas **2566**, the processor(s) **2566** may be caused to instantiate a separate instance of each of the databases **2562**, **2563**, **2564** and/or **2567** within each of those unrelated federated areas **2566**. In other embodiments in which there are multiple federated areas **2566** that are related to each other as by

being included in either a single linear hierarchy (e.g., the example linear hierarchy introduced in FIG. **15A**) or a single hierarchical tree (e.g., the example hierarchical tree introduced in FIGS. **15B-C**), the processor(s) **2566** may be caused to instantiate a single instance of each of the databases **2562**, **2563**, **2564** and/or **2567** that may cover (or be otherwise capable of covering) all of those multiple related federated areas **2566**. However, in still other embodiments in which there are multiple federated areas **2566** that are related to each other as by being included in a single hierarchical tree, the processor(s) **2566** may be caused to instantiate multiple instances of each of the databases **2562**, **2563**, **2564** and/or **2567**, where each of those multiple instances covers a different subset of those multiple related federated areas **2566** that exists within a different one of the branches of the hierarchical tree. Still other embodiments are possible in which each instance of each of the databases **2562**, **2563**, **2564** and/or **2567** may cover one or multiple related and/or unrelated federated areas **2566**.

[**0583**] Within each instance of the job flow database **2562**, the job flow definitions **2220** may be indexed or made otherwise addressable by their corresponding job flow identifiers **2221**. In some embodiments, DAGs **2270** may be stored within each instance of the job flow database(s) **2562** alongside the job flow definitions **2220**. As has been discussed, new job flow definitions **2220** may be at least partially based on DAGs **2270**.

[**0584**] Within each instance of the data object database **2563**, the data sets **2330** and/or **2370** may be accessible via their corresponding data object identifiers **2331**, and/or each of the result reports **2770** may be accessible via their corresponding result report identifiers **2771**.

[**0585**] Within each instance of the task routine database **2564**, the task routines **2440** may be indexed or made otherwise addressable both by their corresponding task routine identifiers **2441**, and by the flow task identifiers **2241** that each may also be assigned to indicate the particular task that each is able to perform. As has been discussed, there may be tasks that multiple task routines **2440** are able to perform such that there may be sets of multiple task routines **2440** that all share the same flow task identifier **2241**. In some embodiments, a search of an instance of the task routine database **2564** using a flow task identifier **2241** to find a task routine **2440** that is able to perform the corresponding task may beget an indication from that instance of the task routine database **2564** of there being more than one of such task routines **2440**, such as a list of the task routine identifiers **2441** of such task routines **2440**. Such an indication may also include an indication of which of the multiple task routines **2440** so identified is the most recent version thereof. Such an indication may be provided by an ordering of the task routine identifiers **2441** of the multiple task routines **2440** that places the task routine identifier **2441** of the most recent version of the task routines **2440** at a particular position within the list. In this way, indications of whether one or multiple task routines **2440** exists that are able to perform a task, as well as which one of multiple task routines **2440** is the newest version, may be quickly provided from an instance of the task routine database **2564** in a manner that obviates the need to access and/or analyze any of the task routines **2440** therefrom.

[**0586**] In some embodiments, macros **2470** may be stored within each instance of the task routine database(s) **2564** alongside the task routines **2440** from which each macro

2470 may be derived. As will be explained in greater detail, it may be deemed desirable to enable each macro 2470 to be searchable based on either the task routine identifier 2441 of the specific task routine 2440 from which it was generated, or the flow task identifier 2241 of the task that the task routine 2440 performs.

[0587] Within each instance of the instance log database 2567, the instance logs 2720 may be indexed or made otherwise addressable by their corresponding instance log identifiers 2721. As has been discussed, each performance of a job flow may cause the generation of a separate corresponding instance log 2720 during that performance that provides a log of events occurring during the performance, including and not limited to, each performance of a task. In such embodiments, each instance log 2720 may be implemented as a separate data structure and/or file to provide indications of events occurring during the performance to which it corresponds. However, other embodiments are possible in which each of the instance logs 2720 is implemented as an entry of a larger log data structure and/or larger log data file, such as an instance of the instance log database 2567. In some embodiments, the manner in which the instance log identifiers 2721 of the instance logs 2720 are stored within an instance of the instance log database 2567 (or other data structure) may be structured to allow each of the instance log identifiers 2721 to be searched for at least portions of particular identifiers for other objects that were concatenated to form one or more of the instance log identifiers 2721. As will shortly be explained in greater detail, enabling such searches to be performed of the instance log identifiers 2721 may advantageously allow an instance log 2720 for a particular performance of a particular job flow to be identified in a manner that obviates the need to access and/or analyze any of the instance logs 2720 within an instance log database 2567.

[0588] As previously discussed, each of the object identifiers 2221, 2331, 2441, 2721 and/or 2771 may be accompanied by a corresponding object location identifier 2222, 2332, 2442, 2722 and/or 2772, respectively, that serves to indicate at least which federated area 2566 of the multiple related federated areas 2566 that the corresponding object may be stored within. Thus, and more precisely, each job flow identifier 2221 may be accompanied by a job flow location identifier 2222 that serves to identify which of multiple related federated areas 2566 the corresponding job flow definition 2220 or DAG 2270 is stored within. Similarly, each data object identifier 2331 may be accompanied by a data object location identifier 2332 that serves to identify which of multiple related federated areas 2566 the corresponding data set 2330 or 2370 is stored within. Similarly, each result report identifier 2771 may be accompanied by a result report location identifier 2772 that serves to identify which of multiple related federated areas 2566 the corresponding result report 2770 is stored within. Similarly, each task routine identifier 2441 may be accompanied by a task routine location identifier 2442 that serves to identify which of multiple related federated areas 2566 the corresponding task routine 2440 or macro 2470 is stored within. Similarly, each instance log identifier 2721 may be accompanied by an instance log location identifier 2722 that serves to identify which of multiple related federated areas 2566 the corresponding instance log 2720 is stored within.

[0589] FIG. 18B depicts the resulting hierarchy-wide coverage of the resulting single set of object identifiers 2221,

2331, 2441, 2771 and/or 2721, and object location identifiers 2222, 2332, 2442, 2772 and/or 2722, respectively, in embodiments in which a single instance of each of the databases 2562, 2563, 2564 and/or 2567 covers all of the multiple federated areas 2566 within a single set of related federated areas within a single hierarchical structure, such as the depicted example hierarchical tree introduced in FIGS. 15B-C. Thus, the single depicted set of object identifiers and object location identifiers may be used in retrieving any of the corresponding types of objects that may be stored within any of the federated areas 2566m, 2566g, 2566r, 2566u and 2566x of the depicted example hierarchical tree.

[0590] In contrast, FIG. 18C depicts the resulting per-branch coverage of the resulting multiple sets of object identifiers 2221m, 2331m, 2441m, 2771m and/or 2721m; 2221q, 2331q, 2441q, 2771q and/or 2721q; and/or 2221r, 2331r, 2441r, 2771r and/or 2721r; and object location identifiers 2222m, 2332m, 2442m, 2772m and/or 2722m; 2222q, 2332q, 2442q, 2772q and/or 2722q; and/or 2222r, 2332r, 2442r, 2772r and/or 2722r; respectively, in embodiments in which a separate instance of each of the databases 2562, 2563, 2564 and/or 2567 covers a different subset of the multiple federated areas 2566 within a different branch of a single set of related federated areas within a single hierarchical tree. Thus, one of the depicted sets of object identifiers and object location identifiers may be used in retrieving any of the corresponding types of objects that may be stored within either of the federated areas 2566m or 2566x; while another of the depicted sets of object identifiers and object location identifiers may be used in retrieving any of the corresponding types of objects that may be stored within any of the federated areas 2566g, 2566u or 2566x; and still another of the depicted sets of object identifiers and object location identifiers may be used in retrieving any of the corresponding types of objects that may be stored within any of the federated areas 2566r, 2566u or 2566x.

[0591] Turning to FIG. 18D, and as previously discussed, the federated device(s) 2500 may receive a request from one of the source devices 2100, or from one of the reviewing devices 2800, to retrieve one or more objects associated with a job flow from within the federated area(s) 2566 and provide it to the requesting device 2100 or 2800. Alternatively, the request may be to use one or more objects associated with a job flow, and retrieved from the federated area(s) 2566, to perform an analysis and provide the results thereof. Or, as an another alternative, the request may be to use one or more objects associated with a job flow, and retrieved from the federated area(s) 2566, to repeat a past performance of that job flow and provide the results thereof and/or the results of a comparison of past and new results thereof. In some embodiments, the processor(s) 2550 of the federated device(s) 2500 may be caused by the portal component 2549 to queue such requests as request data 2535 to enable out-of-order handling of requests, and/or other approaches to increase the efficiency with which such requests are responded to. As previously discussed, the processor(s) 2550 may also be caused by the portal component 2549 to determine whether each of the received requests originated from an authorized person, an authorized device and/or an authorized entity, and/or to determine whether the type of request is authorized for originating person, device and/or entity.

[0592] As depicted, the control routine 2540 may also include a selection component 2543 to employ one or more

identifiers provided in a request and/or one or more rules to locate, select and retrieve objects associated with a job flow from the federated area(s) 2566. In executing the selection component 2543 and the database component 2545 to provide requested objects, the processor(s) 2550 may be caused to use one or more identifiers of objects that may be provided in a granted request to directly retrieve those one or more objects from federated area(s) 2566. By way of example, a request may be received for the retrieval and transmission to the requesting device 2100 or 2800 of a particular flow input data set 2330, and the request may include the data object identifier 2331 of the particular flow input data set 2330. In response to the request, the processor (s) 2550 may be caused by the selection component 2543, in cooperation with the database component 2545, to employ the provided data object identifier 2331 and/or the corresponding data object location identifier 2332 to search for the particular flow input data set 2330 within the federated area(s) 2566, retrieve it, and transmit it to the requesting device 2800. In so doing, the processor(s) 2550 may be caused by the selection component 2543 to correlate the received data object identifier 2331 to the corresponding data object location identifier 2332, and to then retrieve the particular flow input data set 2330 from the federated area 2566 indicated by that data object location identifier 2332. Further, in so doing, the processor(s) 2550 may be caused to communicate within one or more storage devices 2600 and/or one or more other federated devices 2500 that may be indicated by the data object location identifier as storing at least a portion of the flow input data set 2330.

[0593] However, other requests may be for the retrieval of objects from federated area(s) 2566 where the identifiers of the requested objects may not be directly provided within the requests. Instead, such requests may employ other identifiers that provide an indirect reference to the requested objects.

[0594] In one example use of an indirect reference to objects, a request may be received for the retrieval and transmission to the requesting device 2100 or 2800 of a task routine 2440 that performs a particular task, and the request may include the flow task identifier 2241 of the particular task instead of a task routine identifier 2441 that directly identifies any particular task routine 2440. The processor(s) 2550 may be caused by the selection component 2543, in cooperation with the database component 2545, to employ the flow task identifier 2241 provided in the request to search within federated area(s) 2566 for such task routines 2440. As has been previously discussed, the search may entail correlating the flow task identifiers 2241 to one or more task routine identifiers 2441 of the corresponding one or more task routines 2440 that may perform the task identified by the flow task identifier 2241. In embodiments in which the task routines 2440 have been organized into a task routine database 2564 within each federated area 2566, or across multiple federated areas 2566, as discussed in reference to FIG. 18A (or other searchable data structure), the search may entail searches within such a database or other data structure. The result of such a search may be an indication from such database(s) or other data structure(s) within the federated area(s) 2566 that there is more than one task routine 2440 that is able to perform the task identified by the flow task identifier 2241 provided in the request. As previously discussed, such an indication may be in the form of a list of the task routine identifiers 2441 for the task routines

2440 that are able to perform the specified task. Additionally, and as also previously discussed, such a list may be ordered to provide an indication of which of those task routines 2440 stored within a federated area 2566 is the newest. Again, it may be deemed desirable to favor the use of the newest version of a task routine 2440 that performs a particular task where there is more than one task routine 2440 stored within federated area(s) 2566 that is able to do so. Therefore, in response to the request, the processor(s) 2550 may be caused by the selection component 2543 to select the newest task routine 2440 indicated among all of the one or more of such lists retrieved within each federated area 2566 to perform the task specified in the request by the flow task identifier 2241, and to transmit that newest version to the requesting device. Through such automatic selection and retrieval of the newest versions of task routines 2440, individuals and/or entities that may be developing new analyses may be encouraged to use the newest versions.

[0595] In another example use of an indirect reference to objects, a request may be received by the federated device(s) 2500 to repeat a previous performance of a specified job flow with one or more specified data objects as inputs (e.g., one or more of the data sets 2330), or to provide the requesting device with the objects needed to repeat the previous performance of the job flow, itself. Thus, the request may include the job flow identifier 2221 of the job flow definition 2220 for the job flow, and may include one or more data object identifiers 2331 of the one or more data sets 2330 to be employed as inputs to the previous performance of that job flow sought to be repeated, but may not include identifiers for any other object associated with that previous performance.

[0596] The processor(s) 2550 may be caused by the selection component 2543 to employ the job flow identifier 2221 and the one or more data objects identifiers 2331 provided in the request to search the one or more federated areas 2566 for all instance logs 2720 that provide an indication of a past performance of the specified job flow with the specified one or more input data objects. In embodiments in which the instance logs 2720 have been organized into an instance log database 2567 as depicted as an example in FIG. 18A (or other searchable data structure), the search may be within such a database or other data structure, and may be limited to the instance log identifiers 2721. More specifically, in embodiments in which the instance log identifiers 2721 were each generated by concatenating the identifiers of objects associated with a corresponding past performance, the instance log identifiers 2721, themselves, may be analyzed to determine whether the identifiers provided in the request for particular objects are included within any of the instance log identifiers 2721. Thus, the processor(s) 2550 may be caused to search each instance log identifier 2721 to determine whether there are any instance log identifiers 2721 that include the job flow identifier 2221 and all of the data object identifiers 2331 provided in the request. If such an instance log identifier 2721 is found, then it is an indication that the instance log 2720 that was assigned that instance log identifier 2721 is associated with a past performance of that job flow associated with the one or more data sets 2330 specified in the request.

[0597] It should be noted, however, that a situation may arise in which more than one of such instance log identifiers 2721 may be found, indicating that there has been more than one past performance of the job flow with the one or more

data sets specified in the request. In response to such a situation, the processor(s) 2550 may be caused by the selection component 2543 to transmit an indication of the multiple previous performances to the requesting device 2100 or 2800 along with a request for a selection to be made from among those previous performances. The processor(s) 2550 may then await a response from the requesting device 2100 or 2800 that provides an indication of a selection from among the multiple past performances. As an alternative to such an exchange with the requesting device 2100 or 2800, or in response to a predetermined period of time having elapsed since requesting a selection without an indication of a selection having been received by the federated device(s) 2500, the processor(s) 2550 may be caused by the selection component 2543 to, as a default, select the most recent one of the past performances.

[0598] After identifying a single past performance, or after the selection of one of multiple past performances, the processor(s) 2550 may then be caused by the selection component 2543 to retrieve the task routine identifiers 2441 specified within the corresponding instance log 2720 of the particular task routines 2440 used in the previous performance. The processor(s) 2550 may then be caused by the selection component 2543, in cooperation with the database component 2545, to employ those task routine identifiers 2441 to retrieve the particular task routines 2440 associated with the previous performance from one or more federated areas 2566. The processor(s) 2550 may also be caused by the selection component 2543 to retrieve the result report identifier 2771 specified within the instance log 2720 of the result report that was generated in the previous performance. The processor(s) 2550 may be further caused by the selection component 2543, in cooperation with the database component 2543, to retrieve any data object identifiers 2331 that may be present within the instance log 2720 that specify one or more data sets 2370 that may have been generated as a mechanism to exchange data between task routines 2440 during the performance of a job flow.

[0599] If the request was for the provision of objects to the requesting device, then the processor(s) 2550 may be caused by the database component 2543 to retrieve, from the one or more federated areas, the job flow definition 2220 and the one or more data sets 2330 specified by the job flow identifier 2221 and the one or more data object identifiers 2331, respectively, in the request, and may be further caused by the portal component 2549 to transmit those objects to the requesting device 2100 or 2800. The processor 2550 may also be caused by the portal component 2549 to transmit the instance log 2720 generated in the past performance, and the result report 2770 specified by the result report identifier 2771 retrieved from the instance log 2720. If any data sets 2370 were indicated in the instance log 2720 as having been generated in the previous performance, then the processor(s) 2550 may be further caused by the portal component 2549 to transmit such data set(s) 2370 to the requesting device 2100 or 2800 after having been caused to retrieve such data set(s) 2370 from the one or more federated areas 2566 by the database component 2545. Thus, based on a request that provided only identifiers for a job flow definition 2220 and one or more data objects used as inputs to a past performance of the job flow, a full set of objects may be automatically selected and transmitted to the requesting device to enable an independent performance of the job flow as part of a review of that previous performance.

[0600] However, if the request was for a repeat of the previous performance of the job flow by the one or more federated devices 2500, then instead of (or in addition to) transmitting the objects needed to repeat the previous performance to the requesting device 2100 or 2800, the processor(s) 2550 may be caused by execution of a performance component 2544 of the control routine 2540 to use those objects to repeat the previous performance within a federated area 2566 in which at least one of the objects is stored and/or to which the user associated with the request and/or the requesting device 2100 or 2800 has been granted access. In some embodiments, the federated area 2566 in which the previous performance took place may be selected, by default, to be the federated area 2566 in which to repeat the performance. Indeed, repeating the performance within the same federated area 2566 may be deemed a requirement to truly reproduce the conditions under which the previous performance occurred. More specifically, the processor(s) 2550 may be caused to execute the task routines 2440 specified in the instance log 2720, in the order specified in the job flow definition 2220 specified in the request, and using the one or more data sets 2330 specified in the request as input data objects. In some embodiments, where multiple ones of the federated devices 2500 are operated together as the federated device grid 2005, the processor(s) 2550 of the multiple ones of the federated devices 2500 may be caused by the performance component 2544 to cooperate to divide the execution of one or more of the tasks thereamong. Such a division of one or more of the tasks may be deemed desirable where one or more of the data objects associated with the job flow is of relatively large size. Regardless of the quantity of the federated devices 2500 involved in repeating the previous performance of the job flow, upon completion of the repeat performance, the processor(s) 2550 may be further caused by the performance component 2544 to transmit the newly regenerated result report 2770 to the requesting device. Alternatively or additionally, the processor(s) 2550 may perform a comparison between the newly regenerated result report 2770 and the result report 2770 previously generated in the previous performance to determine if there are any differences, and may transmit an indication of the results of that comparison to the requesting device. Thus, based on a request that provided only identifiers for a job flow definition 2220 and one or more data objects used as inputs to the job flow, a previous performance of a job flow may be repeated and the results thereof transmitted to the requesting device as part of a review of the previous performance.

[0601] In still another example use of an indirect reference to objects, a request may be received by the one or more federated devices 2500 to perform a specified job flow with one or more specified data objects as inputs (e.g., one or more of the data sets 2330). Thus, the request may include the job flow identifier 2221 of the job flow definition 2220 for the job flow, and may include one or more data object identifiers 2331 of the one or more data sets 2330 to be employed as input data objects, but may not include any identifiers for any other objects needed for the performance.

[0602] The processor(s) 2550 may be caused by the selection component 2543, in cooperation with the database component 2545, to employ the job flow identifier 2221 provided in the request to retrieve the job flow definition 2220 for the job flow to be performed. The processor(s) 2550 may then be caused to retrieve the flow task identifiers 2241

from the job flow definition 2220 that specify the tasks to be performed, and may employ the flow task identifiers 2241 to retrieve the newest version of task routine 2440 within one or more federated areas 2566 (e.g., within the task routine database 2564 within each of one or more federated areas 2566) for each task. The processor(s) 2550 may also be caused by the selection component 2543 to employ the job flow identifier 2221 and the one or more data objects identifiers 2331 to search the one or more federated areas 2566 for any instance logs 2720 that provide an indication of a past performance of the specified job flow with the specified one or more input data objects.

[0603] If no such instance log identifier 2721 is found, then it is an indication that there is no record within the one or more federated areas of any previous performance of the specified job flow with the one or more specified data sets 2330. Indeed, it may then be assumed that this lack of having any such record is an indication that no such previous performance has occurred. In response, the processor(s) 2550 may be caused by execution of the performance component 2544 to execute the retrieved newest version of each of the task routines 2440 to perform the tasks of the job flow in the order specified in the job flow definition 2220 specified in the request, and using the one or more data sets 2330 specified in the request as input data objects. Again, in embodiments in which multiple ones of the federated devices 2500 are operated together as the federated device grid 2005, the processor(s) 2550 may be caused by the performance component 2544 to cooperate to divide the execution of one or more of the tasks thereamong. Upon completion of the performance of the job flow, the processor(s) 2550 may be further caused by the performance component 2544 to transmit the result report 2770 generated in the performance of the job flow to the requesting device. Thus, based on a request that provided only identifiers for a job flow definition 2220 and one or more data objects used as inputs to the job flow, a performance of a job flow is caused to occur using the newest available versions of task routines 2440 to perform each task.

[0604] However, if such an instance log identifier 2721 is found, then it is an indication that there was a previous performance of the job flow specified in the request where the one or more data sets 2330 specified in the request were used as input data objects. If a situation should occur where multiple ones of such instance log identifiers 2721 are found, then it is an indication that there have been multiple previous performances of the job flow, and the processor(s) 2550 may be caused by the selection component 2543 to select the most recent one of the multiple previous performances, by default. After the finding of a single previous performance, or after the selection of the most recent one of multiple previous performances, the processor(s) 2550 may then be caused by the selection component 2543, in cooperation with the database component 2545, to retrieve the task routine identifiers 2441 specified within the corresponding instance log 2720 of the particular task routines 2440 used in the previous performance. The processor(s) 2550 may then employ those task routine identifiers 2441 to retrieve the particular task routines 2440 associated with the previous performance from one or more federated areas 2566. The processor 2550 may then compare each of the task routines 2440 specified in the instance log 2720 to the newest task routines 2440 retrieved for each task specified in the job flow definition 2220 to determine whether all of the

task routines 2440 specified in the instance log 2720 are the newest versions thereof. If so, then the result report 2770 generated in the previous performance associated with the instance log 2720 was generated using the most recent versions of each of the task routines 2440 needed to perform the tasks of the job flow. The processor(s) 2550 may then entirely forego performing the job flow, may employ the result report identifier 2771 provided in the instance log 2720 to retrieve the result report 2770 generated in the earlier performance, and may transmit that result report 2770 to the requesting device. In this way, a form of caching is provided by which the previously generated result report 2770 is able to be recognized as reusable, and the use of processing resources of the one or more federated devices 2500 to repeat a previous performance of the job flow is avoided.

[0605] It should be noted, however, that a situation may arise in which one or more of the task routines 2440 specified in the instance log 2720 are the newest versions thereof, while one or more others of the task routines 2440 specified in the instance log 2720 are not. In response to such a situation, the processor(s) 2550 may be caused by the selection routine 2543 to check whether at least the task routine 2440 specified in the instance log 2720 as performing the first task in the order of tasks specified in the job flow definition 2220 is the newest version of task routine 2440 able to perform that task. If not, then the processor(s) 2550 may be caused by the performance component 2544 to employ all of the newest versions of the task routines 2440 to perform the entire job flow, just as the processor(s) 2550 would be caused to do so if there had been no previous performance of the job flow, at all. However, if the first task in the previous performance of the job flow was performed with the newest version of task routine 2440 able to perform that first task, then the processor(s) 2550 may be caused by the selection component 2543 to iterate through each task in the order of tasks specified in job flow definition 2720 to determine which were performed with the newest version of task routine 2440. The processor(s) 2550 would start with the first task in the specified order of tasks, and stop wherever in the specified order of tasks the processor(s) 2550 determine that a task routine 2440 was used that is not the newest version thereof. In this way, the processor(s) 2550 may identify an initial portion of the order of tasks specified in the job flow definition 2220 that may not need to be performed again as they were already performed using the newest versions of their respective task routines 2440. As a result, only the remainder of the tasks that follow the initial portion in the order of tasks may need to be performed again, but using the newest versions of their respective task routines 2440 for all of those remaining tasks. In this way, a form of partial caching is provided by which an initial portion of a previous performance of a job flow is able to be reused such that not all of the job flow needs to be performed again to generate a result report 2770 to be transmitted to the requesting device.

[0606] FIG. 18E illustrates two examples of searching for objects using one or more identifiers that provide an indirect reference to those objects in greater detail. More specifically, FIG. 18E depicts two different searches for objects that each employ the example instance log identifier 2721afg2h associated with the 2720afg2h instance log of the example performance of the job flow 2200/gh of FIGS. 16A-D.

[0607] In one example search, and referring to both FIGS. 18D and 18E, a request may be received (and stored as part of the request data 2535) for the retrieval of objects associated with, and/or for a repetition of, the example performance 2700afg2h that resulted in the generation of the result report 2770afg2h. In so doing, the request may use the result report identifier 2771afg2h to refer to the result report 2770afg2h, while providing no other identifier for any other object associated with the performance 2700afg2h. In response, the processor(s) 2550 may be caused by the selection component 2543, in cooperation with the database component 2545, to search the instance log identifiers 2721 of the instance log database 2567 within one or more federated areas 2566 to locate the one of the multiple instance log identifiers 2721 that includes the result report identifier 2771afg2h. As depicted, the instance log identifier 2721afg2h is the one of the multiple instance log identifiers 2721 that contains the result report identifier 2771afg2h. With the instance log identifier 2721afg2h having been found, the processor(s) 2550 may then be caused by the selection component 2543 to retrieve, from the instance log 2720afg2h, the identifiers of the various objects requested to be transmitted to the requesting device and/or needed to repeat the example performance 2700afg2h.

[0608] In another example search, a request may be received for a repetition of a previous performance of a specific job flow with a specific data object used as input. In so doing, the request may refer to the example job flow 2200fgh of FIGS. 16A-D by using the job flow identifier 2221fgh of the job flow definition 2220fgh that defines the example job flow 2200fgh, and may refer to the data set 2330a by using the data object identifier 2331a. In response, the processor(s) 2550 may be caused by the selection component 2543, in cooperation with the database component 2545, to search the instance log identifiers 2721 of the instance log database 2567 within one or more federated areas 2566 to locate any of the multiple instance log identifiers 2721 that includes the both the job flow identifier 2221fgh and the data object identifier 2331a. As depicted, the instance log identifier 2721afg2h is the one of the multiple instance log identifiers 2721 that contains both of these identifiers 2221fgh and 2331a. With the instance log identifier 2721afg2h having been found, the processor(s) 2550 may then be caused by the selection component 2543 to retrieve, from the instance log 2720afg2h, the identifiers of the various objects needed to repeat the example performance 2700afg2h. The processor(s) 2550 may then be caused by execution of the performance component 2544 to perform the example job flow 2200fgh with the data set 2330a as the input data object.

[0609] Turning to FIG. 18F, while also referring back to FIG. 18D, as an alternative to the federated device(s) 2500 transmitting objects to another device 2100 or 2800 in response to requests, and as previously discussed, the federated device(s) 2500 may, instead, transmit objects to another device 2100 or 2800 as a result of an ongoing synchronization relationship instantiated between transfer area(s) 2666 within one or more federated areas 2566 and other transfer area(s) 2166 or 2866 within a storage 2160 or 2860 of the other device 2100 or 2800, respectively. Again, the instantiation of such synchronization relationship(s) may be in response to a request received by the one or more federated devices 2500. And again, in some embodiments, such synchronization relationship(s) may be requested and

instantiated to support a collaboration among developers who have access to and are familiar with the use of the federated area(s) 2566 of the federated device(s) 2500, and other developers who do not have access to and/or are not familiar with the use of those federated area(s) 2566.

[0610] As previously discussed, such synchronized relationship(s) in which there is a need for translations between programming languages may be instantiated in support of a collaboration among developers to develop an analysis or other routine that includes developers familiar with a primary programming language associated with the use of the federated area(s) 2566, and other developers who may, instead, be familiar with a secondary programming language. Again, such other developers may also be accustomed to relying upon an implementation of a source code management system within the other device 2100 or 2800, instead of being familiar with the use of the federated area(s) 2566.

[0611] Again, in such a situation, such synchronization relationship(s) may entail maintaining synchronization of contents between transfer area(s) 2666 instantiated within federated areas(s) 2566 maintained by the federated device (s) 2500 and transfer area(s) 2166 or 2866 maintained within the storage 2160 or 2860 of the other device 2100 or 2800, respectively. Again, the transfer area(s) 2166 or 2866 may be defined to occupy the portion of the storage 2160 or 2860 of the device 2100 or 2800 within which a source code management system maintains a copy of all of the executable instructions. Correspondingly, the transfer area(s) 2666 instantiated within federated area(s) 2566 may also be the designated location(s) in which portions of the executable instructions of the analysis or other routine are to be stored as objects. With these transfer areas and their synchronization relationship having been instantiated, it may be that the processor(s) 2550 of the federated device(s) 2500 are caused to cooperate with the processor(s) 2150 of the device 2100 in which the transfer area(s) 2166 are instantiated, or the processor(s) of the device 2800 in which the transfer area(s) 2866 are instantiated, to use instances in which changes to portions of executable instructions have been “committed” or at least “checked in” as a trigger to cause the transfer of the affected object(s) therebetween.

[0612] Continuing with FIG. 18F, regardless of the exact manner in which the federated device(s) 2500 are caused to transmit an object to another device 2100 or 2800, it may be that the other device 2100 or 2800 requires a portion of the transmitted object to be written in a secondary programming language that is not utilized by the processor(s) 2550 of the federated device(s) 2500 in the performance of job flows. In some embodiments, it may be that this requirement is to be applied to job flow definitions 2220 that are to be transmitted by the federated device(s) 2500 back to the other device 2100 or 2800, as it may be that at least some other types of object may not be transmitted back to the other device 2100 or 2800. Thus, in such embodiments, the depicted job flow definition 2220p, which includes input and/or output interface definitions written in the primary programming language, is to be translated into the depicted other form 2220s, which includes corresponding input and/or output interface definitions written in the secondary programming language.

[0613] In some of such embodiments, the processor(s) 2550 of the federated device(s) 2500 may be caused to perform a reverse form of the translation process earlier described in connection with FIG. 17B by which the job

flow definition **2220_p** stored within a federated area **2566** may have been generated from an earlier received version thereof in which the input and/or output interface definitions were written in a secondary language. More specifically, the processor(s) **2550** may be caused to translate the input and/or output interface definitions within the depicted job flow definition **2220_p** into an intermediate representation, just as might normally be done to enable a comparison to input and/or output interface implementations by one or more task routines **2440**. Subsequently, the processor(s) **2550** may be caused to translate the input and/or output definitions from the intermediate representation and into the secondary programming language within the depicted job flow definition **2220_s** that is transmitted to the other device **2100** or **2800**.

[0614] Alternatively, in other embodiments in which the transmission of objects back to the other device **2100** or **2800** is limited to job flow definitions **2220**, and in which at least the input and/or output interface definitions thereof are required to be written in the secondary programming language, the processor(s) **2550** may be caused by the interpretation component **2547** to perform a direct translation from the at least the input and/or output definitions written in the primary programming language within the depicted job flow definition **2220_p**, and into at least the input and/or output definitions written in the secondary programming language within the depicted job flow definition **2220_s** that is transmitted to the other device **2100** or **2800**. Such a direct translation may be deemed desirable where a fuller translation capability is needed as a result of the depicted job flow definition **2220_p** also including GUI instructions that need to be translated from the primary programming language into the secondary programming language to generate corresponding GUI instructions within the depicted job flow definition **2220_s**.

[0615] As previously discussed, job flow definitions **2220** may be derived from DAGs **2270** and/or vice versa. As also previously discussed, embodiments are possible in which different DAGs **2270** may be generated in different languages, and such different languages may be the same differing programming languages as used in portions of job flow definitions **2220**. Alternatively, such different languages may be differing forms of notation, and each may be associated with a different programming language and/or a different development environment. Thus, like job flow definitions **2220**, it may be that DAGs **2270** exchanged between the one or more federated devices **2500** and another device **2100** or **2800** may also be at least partially translated such that, as depicted, for a DAG **2270_p** stored within a transfer area **2666** within a federated area **2566** that employs a primary programming language or primary form of notation, there may be a corresponding DAG **2270_s** that is generated therefrom and stored within a transfer area **2166** or **2866** within a storage **2160** or **2860**, respectively, that employs a secondary programming language or secondary form of notation to provide the same view of the same job flow **2200**, of the same instance of performance of a job flow **2200**, of the same task and/or of the same task routine **2440**.

[0616] Turning to FIG. 18G, also regardless of the exact manner in which the federated device(s) **2500** are caused to transmit an object to another device **2100** or **2800**, it may be that the other device **2100** or **2800** requires being provided with a large data object that had been previously stored in a distributed manner among multiple storage devices **2600_{a-x}**

and/or **2600_z**, such as the depicted flow input data set **2330**. As a result, a whole version of the flow input data set **2330** may need to be reassembled (e.g., in a reduction operation) from the multiple blocks into which it had been previously divided for storage, such as the depicted multiple data object blocks **2336_d** distributed across the storage devices **2600_{a-x}**, or across the federated devices **2600_{a-x}**, described in connection with FIG. 17C. However, as previously discussed, in some embodiments, it may be that such distributed storage of the flow input data set **2330** had entailed a conversion into a distributable form, such as the conversion that was also earlier described in connection with FIG. 17C. Thus, in such embodiments, reassembly of the flow input data set **2330** from the multiple data object blocks **2336_d** may entail a reversal of the earlier performed conversion into distributable form.

[0617] Therefore, in response to the requirement to provide the flow input data set **2330** to another device **2100** or **2800**, and based on whether the flow input data set **2330** had been converted into a distributable form as part of storing it, the processor(s) **2550** of the one or more federated devices **2500** may be caused by execution of the selection component **2543** and/or the database component **2545** to cooperate with the storage devices **2600_{a-x}** and/or **2600_z**, or with the federated devices **2500_{a-x}** and/or **2500_z**, to retrieve the flow input data set **2330_d** of distributable form from the multiple data object blocks **2336_d** distributed thereamong. As previously discussed in reference to FIG. 17D, it may be that a data object location identifier **2332** is accessed to retrieve indications of aspects of the manner in which the flow input data set **2330** was stored, including and not limited to, indications of having been so converted, of having been stored in a distributed manner, of what federated area **2566** in which it is stored and/or of which devices **2600_{a-x}** and/or **2500_{a-x}** in which it is stored in a distributed manner. Again, such indications may affect the choice of which devices are communicated with to retrieve the flow input data set **2330**.

[0618] In some embodiments in which the flow input data set **2330** is stored across the storage devices **2600_{a-x}**, it may be the storage devices **2600_{a-x}** and/or **2600_z** that perform the work of reassembling the flow input data set **2330_d** from the data object blocks **2336_d** as the flow input data set **2330_d**. Alternatively, it may be the processor(s) **2550** of the federated device(s) **2500** that are to transmit the retrieved flow input data set **2330** to the other device **2100** or **2800** that may be caused to perform such a reassembly.

[0619] With the flow input data set **2330_d** reassembled, the processor(s) **2550** may then perform a reverse conversion of the flow input data set **2330_d** of distributable form into the originally received form of the flow input data set **2330**. In so doing, the processor(s) **2550** may re-create a distinct metadata data structure within the re-created flow input data set **2330** (if such a metadata data structure was present therein, originally), and/or may organized the data items therein into multiple distinct and/or non-homogeneous data structures within the re-created flow input data set **2330** (if such multiple data structures were present therein, originally). Regardless of the exact actions required to re-create the flow input data set **2330** in its originally received form, following such a re-creation, the processor(s) **2550** may then be caused to transmit the newly re-created original form of the flow input data set **2330** to the other device **2100** or **2800** via the network **2999**.

[0620] FIGS. 19A, 19B, 19C, 19D, 19E and 19F, together, illustrate various aspects of the generation of a DAG 2270 based on one or more task routines 2440, and of the use of such a DAG 2270 to provide a visualization 2980 of such one or more task routines 2440. FIG. 19A illustrates aspects of collecting information concerning inputs and/or outputs of at least one task routine 2440 in preparation for generating a DAG 2270. FIG. 19B illustrates aspects of generating a DAG 2270 based on collected information concerning inputs and/or outputs of at least one task routine 2440. FIGS. 19C, 19D and 19E, taken together, illustrate aspects of generating a visualization 2980 of a DAG 2270 to visually indicate a connection or a lack of connection between a pair of task routines. FIG. 19F illustrates aspects of the generation and storage of a new DAG 2270 from a visualization 2980 of an edited DAG 2270.

[0621] FIG. 19A illustrates aspects of the generation of a macro 2470 for each task routine 2440 that may be included in a DAG 2270 as an intermediate step to generating the DAG 2270. Such an intermediate step may be performed where the objects that serve as the sources of the information to be depicted in a DAG 2270 are located remotely from where a visualization 2980 of the DAG 2270 is to be displayed, such as where those objects are stored within federated area(s) 2566 maintained by one or more federated devices 2500, but the DAG 2270 is to be displayed by a source device 2100 or a reviewing device 2800. In such situations, the one or more macros 2470 that are so generated may then be transmitted to the device that is to display the visualization 2980 to enable the DAG 2270 to be generated thereat from the one or more macros 2470. However, it should be noted that, where the DAG 2270 is to be generated and/or a visualization 2980 of it is to be displayed locally (e.g., by a computing device with more direct access to the objects that serve as the sources of the information to be depicted), then the DAG 2270 may be generated more directly, and while foregoing the generation of macro(s) 2470. Also, as an alternative to the generation and transmission of macros 2470 to a remote device that is to display a DAG 2270 generated therefrom, the DAG 2270, itself, may be generated locally (e.g., at one or more of the federated devices 2500) and then an image of the DAG 2270 may be transmitted to the device that is to display a visualization 2980 of the DAG 2270.

[0622] As depicted, an example task routine 2440 from which at least a portion of a DAG 2270 may be generated may include executable instructions 2447 written in any of a variety of programming languages and comments 2448 written in a syntax for comments that may be based on the programming language in which the executable instructions 2447 are written. It should be noted that, for the sake of understandability in presentation, what is depicted is a deliberately simplified example of a task routine 2440 in which there is a single block of comments 2448 that precedes a single block of executable instructions 2447. As also depicted, and in keeping with the earlier discussed approaches to enabling the automated selection of task routines 2440 to perform specific tasks, the depicted example task routine 2440 may include the flow task identifier 2241 that identifies the particular task that is performed by the task routine 2440. As previously discussed, in some embodiments, the flow task identifier may incorporate a task type identifier 2242 that is indicative of a type for the corresponding task that is performed.

[0623] As also depicted, and in keeping with the earlier discussed approaches to organizing task routines 2440 for later retrieval and use, the depicted example task routine 2440 may be stored within a federated area 2566 in which a task routine database 2564 may also be stored that may employ an indexing scheme by which the task routine 2440 is able to be retrieved by the task routine identifier 2441 assigned to it. As has also been previously discussed, the task routine database 2564 may correlate flow task identifiers 2241 of tasks to be performed with task routine identifiers 2441 of the task routine(s) 2440 that perform each of those tasks. However, as previously noted, other mechanisms than a database may be employed to enable the retrieval of task routines 2440 for use in the performances of their respective tasks during the performance of a job flow. As has also been discussed, the federated area 2566 in which the depicted example task routine 2440 is stored may be one of a set of multiple related federated areas 2566, such as a linear hierarchy or a hierarchical tree. Thus, as depicted, the portal data 2539 (or other data structure) may store various parameters associated with each of the multiple federated areas 2566 within such a set of federated areas 2566, including aspects of relationships thereamong, and separate federated area identifiers 2568 and/or 2569 for each.

[0624] In executing the interpretation component 2547, the processor(s) 2550 of the one or more federated devices 2500 may be caused to parse the comments 2448 (whether divided into multiple blocks throughout the task routine 2440, or not) to identify, retrieve and interpret at least portions of the comments 2448 that specify aspects of inputs and/or outputs of the task routine 2440. Such aspects that may be so specified may include, and are not limited to, data types of data objects received as inputs and/or generated as outputs, and/or indexing schemes that may be employed in accessing data within data objects. Some of such comments 2448 may identify particular data objects used as inputs and/or generated as outputs, and this may be done to provide default selections of data objects. Alternatively, others of such comments 2448 may avoid doing so as part of an approach to allowing particular data object(s) to be specified by a job flow definition, or in any of a variety of other ways, during the performance of a job flow in which the task routine may be executed.

[0625] In parsing the comments 2448, the processor(s) 2550 may be caused to retrieve various rules for interpreting the contents of the task routine 2440 from a stored set of parameter rules 2537, including language interpretation rules for at least the particular programming language in which the task routine 2440 was written. The processor(s) 2550 may be caused to use such rules to distinguish the comments 2448 from at least the executable instructions 2447, and may use such rules to interpret them.

[0626] In executing the interaction component 2548, the processor(s) 2550 of the one or more federated devices 2500 may be caused to generate a macro 2470 corresponding to the task routine 2440 that includes one or more input/output (I/O) parameters 2478 that indicate the details concerning inputs and/or outputs that are retrieved from the executable instructions 2447 and/or the comments 2448 of the task routine 2440. Additionally, other pieces of information may also be included in the macro 2470, such as the flow task identifier 2241 indicating the task performed when the task routine 2440 is executed, and/or the federated area identi-

fiers 2568 and/or 2569 of the federated area 2566 in which the depicted example task routine 2440 is stored.

[0627] In some embodiments, the processor(s) 2550 of the one or more federated devices 2500 may additionally compare aspects of inputs and/or outputs indicated in the comments 2448 to how those aspects are actually implemented in the executable instructions 2447 to determine whether they match. Where discrepancies are detected, side by side sets of I/O parameters 2478 may be stored within the depicted example macro 2470, with one based on the comments 2448 and the other based on the executable instructions 2447, as a way of indicating a discrepancy therebetween. This may be deemed desirable to allow the details of such a discrepancy to be displayed as part of the DAG 2270 that is later generated from the macro 2470.

[0628] Turning to FIG. 19B, as depicted, an example DAG 2270 may be generated and then visually presented in an example visualization 2980 in which the example task routine 2440 of FIG. 19A is represented with a combination of graph objects, including a task graph object 2984 accompanied by an input data graph object 2983 and an output data graph object 2987. Where the depicted DAG 2270 is generated within federated device(s) 2500, it may be that the processor(s) 2550 thereof are caused to do so by execution of at least the interaction component 2548. It should be noted that, for the sake of understandability in presentation, what is depicted is a deliberately simplified example of a DAG 2270 in which there is a single task routine 2440 depicted that has a single input and a single output. However, it is envisioned that other embodiments of the DAG 2270 may be generated that may include representations of a great many task routines 2440 of which many would may include multiple inputs and/or multiple outputs.

[0629] As depicted in the example visualization 2980, the graph objects 2983, 2984 and 2987 that form such a representation of the task routine 2440 of FIG. 19A may each be selected to visually conform, to at least some degree, to version 2.0 of the BPMN specification for visual representations of objects. More specifically, a rounded rectangle may be selected to be the task graph object 2984, and circles connected to the task graph object 2984 by arrows may be selected to be the data graph objects 2983 and 2987. In generating the task graph object 2984, some form of identifier of the task routine 2440 may be placed within the rounded rectangle shape thereof. In some embodiments, such an identifier may be the task routine identifier 2441 assigned to the task routine 2440 and/or the flow task identifier 2241 that identifies the task performed by the task routine 2440, each of which may be included within and retrieved from the macro 2470. However, as previously discussed, at least the task routine identifier 2441 may be a hash value of numerous bytes in size generated by taking a hash of at least a portion of the task routine 2440 such that the task routine identifier 2441 may be cumbersome for personnel to read, recognize and use as a mechanism to uniquely identify the task routine 2440. Therefore, the task routine 2440 may be assigned a less cumbersome textual name that may be placed within the rounded rectangle shape of the task graph object 2984. It may be that such an assigned textual name may be based on a name given to the file in which the task routine 2440 is stored in embodiments in which objects are stored within the federated area(s) 2566 as files with textual file names. Alternatively or additionally,

it may be that such an assigned textual name may be specified in the comments 2448 of the task routine 2440.

[0630] Additionally, in embodiments in which the task routine 2440 is stored within a federated area 2566 that belongs to a set of related federated areas 2566, some form of identifier of the specific federated area 2566 in which the task routine 2440 is stored may be placed within the rounded rectangle shape of the task graph object 2984. In some embodiments, such an identifier may be the human-readable federated area identifier 2568. As previously discussed, it may be that the human-readable federated area identifier 2568 is a URL that may include a textual name given to the federated area 2566, and may additionally indicate a path among multiple federated areas 2566 by which the federated area 2566 that stores the task routine 2440 is connected to a base federated area 2566 (unless the federated area 2566 in which the task routine 2440 is stored is the base federated area). Further, in embodiments in which the human-readable federated area identifier 2568 is a URL and in which the task routine 2440 is assigned a textual name based on a file name, the human-readable federated area identifier 2568 may be combined with such a name into a single string of text within the rounded rectangle that both identifies the task routine 2440 and specifies its location among the set of related federated areas 2566 in relation to the base federated area thereof.

[0631] In generating the input data graph object 2983, some form of identifier of the input data object represented thereby may be placed within or adjacent to the input data graph object 2983. Similarly, in generating the output data graph object 2987, some form of identifier of the output data object represented thereby may be placed within or adjacent to the output data graph object 2987. As previously discussed, the comments 2448 within a task routine 2440 may provide a more or less specific indication of a data object serving as an input or an output, and this may depend on whether it is intended that a data object is to be specified when the task routine 2440 is executed as part of a performance of a job flow, or the identity of the data object is already known such that it is able to be specifically identified in the comments 2448.

[0632] Focusing, for sake of ease of discussion, on the input data graph object 2983, if the identity of the specific data object for this input (e.g., the depicted example data set 2330) is already known at the time the task routine 2440 is written, then some form of identifier of that specific data object may be specified in the comments 2448 and/or in the executable instructions 2447. In some embodiments, such an identifier may be the data object identifier 2331 assigned to the depicted example data set 2330. However, as previously discussed, as with the task routine identifier 2441 of the task routine 2440, the data object identifier 2331 may also be a hash value of numerous bytes in size such that the data object identifier 2331 may also be cumbersome for personnel to read, recognize and use. Therefore, as with the task routine 2440, the depicted data set 2330 may be assigned a less cumbersome textual name that may be incorporated into its data set metadata 2338, and this textual name may be placed within or adjacent to the circular input data graph object 2983. As with such a textual name that may be assigned to the task routine 2440, such a textual name assigned to the data set 2330 may be based on a name given to the file in which the data set 2330 is stored in embodi-

ments in which objects are stored within the federated area(s) 2566 as files with textual file names.

[0633] As previously discussed, in some embodiments, it may be that the metadata 2338 includes an indication of a type of task with which the data set 2330 may be compatible. As depicted, such an indication may be the inclusion of a task type identifier 2242 for the corresponding compatible type of task. As an alternative to, or in addition to, incorporating such an indication into the metadata 2338, it may be that such a task type identifier 2242, or other indication of compatible task type, is incorporated into a textual name given to the data set 2330 (e.g., a file name of the data set 2330). Regardless of the exact manner in which a task type is specified within the depicted task routine 2440, and regardless of the exact manner in which a compatible task type is indicated for the depicted data set 2330, it may be that, as part of generating the depicted example DAG 2270, processor(s) 2550 may be caused to use those indications of task type to determine whether the depicted data set 2330 is compatible with the task type of the depicted task routine 2440 with which the depicted data set 2330 is to be used. If an incompatibility is determined to exist, then the resulting DAG 2270 may be generated to include a visual indication of an incompatibility error.

[0634] However, and still focusing on the input data graph object 2983, if the identity of the specific data object for this input is not already known at the time the task routine 2440 is written, then the name of a variable or some other form of placeholder may be specified in the comments 2448 and/or in the executable instructions 2447. In such embodiments, it may be the name or other identifier of that variable or other type of placeholder that may be placed within or adjacent to the circular input data graph object 2983. It should be noted that such approaches to providing a visual indication of the identity of the input data object associated with the depicted input data graph object 2983 may also be applied to providing a visual indication of the identity of the output data object (not shown) associated with the depicted output data graph object 2987.

[0635] FIGS. 19C and 19D, taken together, depict an embodiment of an approach to conveying either the presence of a dependency or the lack of a dependency between two task routines in visualizations 2980 of contrasting examples of DAGs 2270. Each of the example visualizations 2980 of FIGS. 19C and 19D includes representations of two task routines 2440a and 2440b, where the task routine 2440a is represented by a combination of a task graph object 2984a and corresponding data graph objects 2983 and 2987, and where the task routine 2440b is represented by a combination of a task graph object 2984b and other corresponding data graph objects 2983 and 2987. However, in the visualization 2980 of FIG. 19C, a vertical arrangement of the representations of the task routines 2440a and 2440b is used to provide a visual indication of no dependency therebetween, such that there is no data object output by one of the task routines 2440a and 2440b that is needed as an input to the other. In contrast, in the visualizations 2980 of FIGS. 19D and 19E, a horizontal arrangement of the representations of the task routines 2440a and 2440b provides the suggestion of a left-to-right path of dependency from the task routine 2440a to the task routine 2440b. Reinforcing this indication of such a dependency is an additional arrow pointing from the representation of the task routine 2440a to the representation of the task routine 2440b. It should be

noted that, although such a use of an arrow is depicted as providing an indication of such a dependency (regardless of whether horizontal arrangement is also used), any of a variety of other forms of indication of such a dependency may be used in other embodiments. By way of example, color coding, graphical symbols and/or other form of visual connector indicative of the dependency may be used to.

[0636] In situations in which a visualization 2980 is to be generated of a DAG 2270 that includes multiple task routines 2440, the details of the inputs and outputs of each of the task routines may be analyzed to identify any instances that may be present of a particular data object having been specified as both an output of one task routine 2440 and an input of another task routine 2440. Such a situation, if found, may be deemed to indicate a dependency in which the one task routine 2440 provides the particular data object that is needed as an input to the other 2440, such as what is depicted in FIG. 19D between the output of task routine 2440a and the input of task routine 2440b. Again, as a result of such a dependency, execution of the task routine 2440a may be required to occur ahead of the execution of the task routine 2440b so as to ensure that the output of the task routine 2440a is able to be provided to the task routine 2440b for use during its execution.

[0637] Turning to FIG. 19E, in some embodiments and as previously discussed, where a visualization is to be generated from a job flow definition 2200, it may be that the dependencies between task routines 2440 may be set forth within the flow definition 2225 using two variations of syntax. More specifically, and as discussed in reference to FIG. 16D, it may be that a syntax is used in which all of the data objects that are received as inputs and that are generated as outputs for a task are all explicitly indicated, thereby providing more information about data objects that may be depicted in a DAG 2270 with input data graph objects 2983 and/or output data graph objects 2987. However, as was also discussed, it may also be that, an alternate syntax is used in which at least some dependencies are set forth in a manner in which one task is referred to as an input into another task such that the one task is actually referred to as if it were a data object. As a result, in such an alternate syntax, the fact that a data object is exchanged between the two tasks is implied, rather than explicit, with the result that there may be fewer details available concerning such an implied data object than may be available about other data objects. Thus, where the exchange of a data object is so implied, the resulting visualization 2980 may depict only an arrow (or other similar graphical element suggestive of a linkage) extending from one task graph object 2984a and to another task graph object 2984b, and without any form of input data graph object 2983 or output data graph object 2987 that explicitly depicts the data object that is exchanged.

[0638] FIG. 19F depicts aspects of the generation and storage, within a federated area 2566, of a new DAG 2270 from a visualization 2980 of an earlier DAG 2270 that may have been edited. More specifically, in some embodiments a UI may be provided to allow editing of aspects of one or more task routines 2440 of an existing DAG 2270 by graphically editing corresponding aspects of graph objects 2983, 2984 and/or 2987 of one or more corresponding representations of task routines 2440. Thus, where a visualization 2980 is initially generated of a DAG 2270, provision may be made for such editing to allow details of a new DAG 2270 to be developed. Further, upon completion of

such editing, the new DAG 2270 thusly developed may then be stored within a federated area 2566, and may subsequently be used as at least a basis for a new job flow definition 2220 that defines a new job flow.

[0639] Such editing may entail changing the visual indication(s) of one or more I/O parameters 2478 that may be visually indicated within or adjacent to an input data graph object 2983 or an output data graph object 2987 to thereby change the one or more I/O parameters 2478 that correspond to those visual indication(s). More specifically, where a name or other identifier of a data object 2330 or 2370 that is generated as an output of a task routine 2440 is visually presented adjacent to the corresponding output data graph object 2987, an edit made in which that name or other identifier is changed in the visualization 2980 may trigger a corresponding change in what data object 2330 or 2370 is generated as an output. Correspondingly, where a name or other identifier of a data object 2330 or 2370 that is used as an input to a task routine 2440 is visually presented adjacent to the corresponding input data graph object 2983, an edit made in which that name or other identifier is changed in the visualization 2980 may trigger a corresponding change in what data object 2330 or 2370 is used as an input. As a result of such editing capabilities being provided, dependencies between task routines may be created, changed and/or entirely removed. In at least this way, the order of performance of tasks, and/or which tasks are able to be performed in parallel, may be changed as part of creating a new DAG 2270 that may be employed as at least part of a new job flow definition 2220.

[0640] As previously discussed, a DAG 2270 may be stored in a federated area as a script generated in a process description language such as BPMN. In some embodiments, at least a subset of the job flow definitions 2220 maintained within one or more federated areas 2566 by the one or more federated devices 2500 may also be stored, at least partially, as scripts in such a process description language as BPMN. Thus, there may be few, if any, differences in the contents of DAGs 2270 vs. job flow definitions 2220 such that a DAG 2270 may be usable as a job flow definition 2220 with little or no modification. It is for this reason that DAGs 2270 may be stored alongside job flow definitions 2220 in the earlier described job flow database 2562.

[0641] FIGS. 20A, 20B, 20C, 20D, 20E, 20F, 20G, 20H, 20I and 20J, together, illustrate various aspects of providing coordination through message queues to better enable the use of a resource allocation routine 2411 to dynamically allocate processing, storage and/or other resources of the federated device(s) 2500 and/or of the storage device(s) 2600 through the dynamic allocation of containers 2565 for the execution of routines within pods 2661. As is about to be explained, containers 2565 may be dynamically allocated within various types of pods 2661 that support the execution of various different routines, including and not limited to, portal pods 2661_p, performance pods 2661_e, a scaling pod 2661_x, task pods 2661_t and kill pods 2661_k. FIGS. 20A-C illustrate aspects of an overall architecture for providing such coordination, including configuration of pod types, distribution of task pods 2661_t, and instantiation of message queues 2669. FIG. 20F illustrates aspects of the coordinated allocation of containers 2565 within portal pods 2661_p to support the execution of one or more instances of the portal component 2549. FIG. 20G illustrates aspects of the coordinated allocation of containers 2565 within performance

pods 2661_e to support the execution of one or more instances of the performance component 2544. FIG. 20H illustrates aspects of the coordinated allocation of containers 2565 within task pods 2661_t to support the execution of task routines 2440. FIG. 20I illustrates aspects of the coordinated allocation of at least one container 2565 within a kill pod 2661_k to support the execution of a kill routine 2515. FIG. 20H illustrates aspects of coordinating needed quantities of different types of pods 2661 with the resource allocation routine 2411.

[0642] Turning to FIG. 20A, in some embodiments, as part of implementing MTC in which complex analysis routines may be implemented as multiple task routines 2440 that are executed in a distributed manner under the control of a job flow definition 2220, a resource allocation routine 2411 may be relied upon to dynamically instantiate, maintain and/or unstantiate containers 2565 within which the task routines 2440 and other routines that coordinate such distributed execution may each be separately executed. As previously discussed, the resource allocation routine 2411 may be an implementation of Kubernetes or similar software that allocates such containers 2565 within multiple pods 2661 of various types. As will be familiar to those skilled in the art, the overall quantity of the pods 2661 (and accordingly, the overall quantity of containers 2565) that are currently allocated may fluctuate under the control of the resource allocation routine 2411 in response to changes in the level of availability of processing, storage, communications and/or other resources within each of the device(s) 2500 and/or 2600, and/or within each of the VMs 2505. More specifically, and as previously discussed, the overall quantity of currently allocated pods 2661 may be dynamically increased through the instantiation of one or more pods 2661, and may be dynamically decreased through the un instantiation of one or more pods 2661, and such instances of instantiation and un instantiation may occur without any coordination with the timing of when the execution of any routine within any container 2565 is commenced or is completed.

[0643] The uncoordinated instantiation of one or more new pods 2661 (and accordingly, one or more new containers 2565 within which routines may be executed) may present no issue to the successful execution of task routines 2440 associated with a job flow, and no issue to the successful execution of other routines that serve to coordinate such executions of task routines 2440. Stated differently, the instantiation of a new container 2565, regardless of when it occurs, may have little or no affect on the executions of routines already underway in other containers 2565 that already exist. However, the uncoordinated un instantiation of a pod 2661 necessarily causes the uncoordinated un instantiation of a container 2565 within which the execution of a routine may be underway, thereby causing such execution of that routine to cease with aspects of the execution of that routine in an unknown state, such that resumption of the execution of that routine from the point at which execution ceased may not be possible.

[0644] To mitigate the effects of such events on the distributed execution of task routines 2440 of a job flow, a message broker routine 2419 may maintain a set of message queues 2669 through which particular types of messages are exchanged among particular subsets of the various types of pods 2661. The particular messages that are exchanged and the protocols that are used in doing so may provide a mechanism to maintain information concerning the current

state of execution of various ones of the routines within the containers **2565**. In this way, an uncoordinated uninstantiation of a pod **2661** that, in turn, causes the uncoordinated cessation of execution of a routine within a container **2565** of that pod **2661**, may be responded to by causing the commencement of execution of a new instance of that same routine within another container **2565** of another pod **2661**, when available. Stated differently, such commencement of execution of a new instance of that same routine within another container **2565** may be occasioned upon: 1) the completion of execution of another routine within an existing container **2565** within an existing pod **2565**, such that the existing container **2565** becomes available for use; or 2) the instantiation of an entirely new container **2565** within a newly instantiated pod **2661**, such that a new container **2565** becomes available for use.

[0645] Turning to FIGS. 20B-D, in being executed by processor(s) **2550** of the federated device(s) **2500**, the resource allocation routine **2411** may be caused to dynamically allocate a set of multiple pods **2661** of multiple types in accordance with configuration information stored within pod configuration data **2631**. More specifically, the pod configuration data **2631** may specify each type of pod **2661** that is to be instantiated; a quantity or range of quantities of each type of pod **2661** that is to be maintained (e.g., a maximum and/or a minimum quantity per type); levels of one or more types of resource required to support each type of pod **2661**; types of containers **2565** to be instantiated within each type of pod **2661**; a quantity or range of quantities of each type of container that is to be maintained within each type of pod **2661**; particular routines that are to be executed within each type of container **2565** within each type of pod **2661**; various aspects of communications (e.g., messaging) that are to be permitted with the environment external to each type of pod **2661**; and/or various aspects of exchanges of objects that are to be permitted with the environment external to each type of pod **2661** (e.g., with federated areas **2566**).

[0646] In some embodiments, the pod configuration data **2631** may specify at least some parameters as a set of environment variables that may be made available to each of the pods **2661** of each type. Such environment variables may be provided to each pod **2661** as each pod **2661** is instantiated, and/or may be made accessible to each pod **2661** as values that are able to be queried for from within each pod **2661**. Additionally, regardless of the exact manner in which such environment variables are provided to each pod **2661**, it may be that, within each pod **2661**, one or more of such environment variables are made available to the routines executed within the containers **2565** thereof as values that are able to be queried from within each container **2565**.

[0647] By way of example, it may be that at least a portion of the configuration information within the pod configuration data **2631** is written in the syntax of a human-readable programming language such as JSON. Such configuration information may be provided, still in such a format, to the resource allocation routine **2411**. In executing the resource allocation routine **2411**, processor(s) **2550** of the federated device(s) **2500** may be caused to provide at least a portion of such configuration information to each pod **2661** as each pod **2661** is instantiated (at least a portion that includes configuration information relevant to the particular type of pod **2661** that is instantiated), again still in such a format. This may enable a routine executed within one of the

containers **2565** within each such pod to use a callable query procedure to access values from within such a portion of configuration information, and be provided with a table of entries correlating labels of particular environment variables to their values (or other similar data structure).

[0648] Each the earlier mentioned types of pod **2661p**, **2661e**, **2661x**, **2661t** and **2661k** may have both features that are common to all types of pod **2661**, and features that may be unique to each type of pod **2661**, as specified in the pod configuration data **2631**. As an example of commonality among all types of pod **2661**, it may be that the pod configuration data **2631** specifies that all of these types of pod **2661** (e.g., **2661p**, **2661e**, **2661x**, **2661t** and **2661k**) are to be instantiated to include a particular type of container **2565**. More specifically, and as will shortly be discussed, it may be that one of the containers **2565** to be included within all of these types of pod **2661** is specified as being dedicated to the execution of a messaging routine **2414** (e.g., a messaging container **2565m**) to facilitate communications with one or more others of these types of pod **2661** through one or more of the message queues **2669**. However, and as will shortly be explained in greater detail, the messaging routine **2414** within each of the different types of pod **2661** may be configured to exchange different types of message and through different ones of the message queues **2669**, and this may be dependent on the type of pod **2661**.

[0649] As an example of a difference among types of pod **2661**, it may be that the pod configuration data **2631** specifies that 1) another container **2565** (e.g., a portal container **2565p**) within each of the portal pods **2661p** is to be used for the execution of an instance of the portal component **2549**; 2) another container **2565** (e.g., the performance container **2565e**) within each of the performance pods **2661e** is to be used for the execution of an instance of the performance component **2544**; 3) another container **2565** (e.g., the scaling container **2565x**) within the scaling pod **2661x** is to be used for the execution of an instance of a scaling routine **2412**; 4) another container **2565** (e.g., the task container **2565t**) within each of the task pods **2661t** is to be used for the execution of an instance of a task routine **2440**; and/or 5) another container **2565** (e.g., the kill container **2565k**) within each of the kill pods **2661k** is to be used for the execution of an instance of the kill routine **2415**.

[0650] As another example of a difference among types of pod **2661**, and as will shortly be discussed, it may be that each of the task pods **2661t** is to include still another container **2565** (e.g., the resolver container **2565r**) that is to be used for the execution of an instance of a resolver routine **2413**. Thus, the task pods **2661t** may include a greater quantity of containers **2565** than any of the other types of pod **2661** (at least among the types of pod **2661** that have been discussed and/or depicted so far).

[0651] As depicted, it may be that the quantity of the scaling pods **2661x** and of the kill pods **2661k** that are allocated by the resource allocation routine **2411** may be less than the quantities of the others. Indeed, as will shortly be explained in greater detail, it is envisioned that relatively few of each of the scaling pod **2661x** and of the kill pod **2661k** should be needed compared to the other types of pod **2661**.

[0652] As also depicted, it may be that the quantity of the task pods **2661t** that are allocated by the resource allocation routine **2411** may be higher than the quantities of the others. Also, it may be that, in a distributed processing system

including multiple interconnected devices such as multiple federated devices **2500**, the task pods **2661** may be the most widely distributed among those multiple devices. Indeed, it is envisioned that there the task pods **2661** are sufficiently numerous that substantial quantities of task pods **2661** may be instantiated within each such device to enable numerous job flows to be performed in parallel in which many of those job flows have an order of performance of tasks that afford many opportunities for multiple tasks to be performed in parallel.

[**0653**] Turning more specifically to the subject of the instantiation, maintenance and/or un instantiation of the various types of pod **2661** and/or various types of container **2565**, as previously discussed, the resource allocation routine **2411** may dynamically increase and/or decrease the quantities of these various types of pod **2661** and/or container **2565** in response to the changing availability of at least the federated devices **2500** and/or in response to changing levels of availability of various resources provided by at least the federated devices **2500**. In some embodiments, the resource allocation routine **2411** may be provided within indications of such changes in available devices and/or in available resources provided by devices in the device data **2531**. More specifically, the device data **2531** may include, and not be limited to, indications of what devices **2500** and/or **2600** are part of the distributed processing system **2000**, which devices **2500** and/or **2600** are currently available, specific resources provided by each device **2500** and/or **2600**, and/or current levels of availability of each such resource. As previously discussed, such information within the device data **2531** may be repeatedly updated by the device allocation routine **2519**, which may monitor each of the devices **2500** and/or **2600** to recurringly receive indications of changes in such information, therefrom.

[**0654**] Based on such information within the device data **2531** concerning available devices **2500** and/or **2600** and/or available resources, processor(s) **2550** that execute the resource allocation routine **2411** may determine how many of each type of pod **2661** and/or container **2565** is to be instantiated, and within which particular devices **2500** and/or **2600**. Additionally, indications of how many of each type of pod **2661** and/or container **2565**, and which device **2500** and/or **2600** each is instantiated within, may be maintained and repeatedly updated within the pod configuration data **2631**.

[**0655**] However, as has also been discussed, in some embodiments, it may be that VMs **2505** are selectively instantiated within at least a subset of at least the federated devices **2500**, and under the control of a separate and distinct VM allocation routine **2511**, as another mechanism by which resources of at least the federated devices **2500** are selectively allocated. In such embodiments, the resource allocation routine **2411** may treat the VMs **2505** in the same way as federated devices **2500**, as execution of the resource allocation routine **2411** causes the dynamic instantiation, maintenance and/or un instantiation of pods **2661** and/or containers **2565** within VMs **2505** based on the same considerations as within federated devices **2500** (e.g., based on changing availability of VMs **2505** and/or based on changing levels of availability of resources within VMs **2505**). In essence, the resources of at least the federated devices **2500**

would be distributed through a two-layered approach that includes the VMs **2505**, and that includes the pods **2661** and/or containers **2565**.

[**0656**] In some of such embodiments, the allocation of resources through the instantiation of VMs **2505** may be done to define the maximum levels of various resources from one or more of the federated devices **2500** that may be consumed in the performance of task routines **2440** and/or the performance of entire job flows **2200** as part of implementing MTC. Such resources of one or more of the federated devices **2500** that are not made available for implementing MTC may, thereby, be made available for entirely different purposes that may have nothing to do MTC.

[**0657**] Alternatively or additionally, the allocation of resources through the instantiation of VMs **2505** may be done as part of separating the provision of the resources provided by one or more of the federated devices **2500** to different users and/or groups of users in a manner that may provide improved security. More specifically, each user or group of users may be allocated separate VMs **2505** within which each user or group of users may cause separate sets of pods **2661** and/or containers **2565** to be instantiated as part of each user or group of users separately implementing MTC. In some of such embodiments, this may be part of enabling the provision of controlled amounts of the resources of numerous federated devices **2500** of the distributed processing system **2000** to each of multiple users and/or groups of users in a service arrangement in which there may be a fee per unit of resources used by each user or group of users per unit of time. Additionally, it may be that each user or group of user is able to request to be provided access to a varying quantity of VMs **2505** that allows for a dynamic “on demand” scaling up and scaling down of the resources that are provided to meet what may be fluctuating needs.

[**0658**] As will be familiar to those skilled in the art, in some embodiments, it may be that a scholastic, business or governmental entity owns or otherwise possesses and/or controls the distributed processing system **2000**, and may offer its processing resources to other entities under any of a wide variety of paid or unpaid agreements. Thus, it may be such an entity that operates the VM allocation routine **2511** to allocate a separate set of VMs **2505** to each of multiple users and/or groups of users. Each separate set of VMs **2505** may be of a dynamically varying quantity that is to be increased and decreased in accordance with resource needs, or may be of a more static, pre-selected quantity that may change relatively infrequently. Each user or group of users may then operate, within the one or more VMs **2505** that are allocated to them, a separate installation of the resource allocation routine **2411** to dynamically allocate a varying quantity and/or varying variety of pods **2661** and/or containers **2565** as an approach to dividing the resources provided in the one or more VMs **2505** as part of their implementation of MTC.

[**0659**] Thus, it may be the instantiation, maintenance and/or un instantiation of VMs **2505** through the execution of the VM allocation routine **2511** that is more directly responsive to the availability of individual devices **2500** and/or **2600** (and/or the levels of resources provided by each), instead of the instantiation, maintenance and/or un instantiation of pods **2661** and/or containers **2565**. Instead, it may be that the instantiation, maintenance and/or un instantiation of

Pods **2661** and/or containers **2565** is more directly responsive to the availability of individual VMs **2505** (and/or the levels of resources provided by each).

[0660] More specifically, execution of the VM allocation routine **2511** may cause processor(s) **2550** to determine how many VMs **2505** are to be instantiated, and within which particular devices **2500** and/or **2600**, based on availability of individual devices **2500** and/or **2600**, and/or based on levels of availability of resources provided by each. Additionally, indications of how many of VMs **2505** are instantiated, and which device **2500** and/or **2600** each is instantiated within, may be maintained and repeatedly updated within the device data **2531**. As will shortly be explained, there may be more than one type of VM **2505** differentiated by what resources are provided within each, and this may result in separate indications within the device data **2531** of various aspects of VMs **2505** for each type of VM **2505**. Then, based on such information within the device data **2531** concerning available VMs **2505** and/or available resources within each VM **2505**, processor(s) **2550** that execute the resource allocation routine **2411** may determine how many of each type of pod **2661** and/or container **2565** is to be instantiated, and within which particular VMs **2505**. Additionally, indications of how many of each type of pod **2661** and/or container **2565**, and which VM **2505** each is instantiated within, may be maintained and repeatedly updated within the pod configuration data **2631**.

[0661] As will be readily recognizable by those skilled in the art, increasing or decreasing the quantity of devices **2500** and/or **2600** of the distributed processing system **2000** may require a relatively lengthy amount of time, as doing so is likely to entail the physical installation, repair, servicing and/or uninstallation of physical computing device hardware. In contrast, increasing or decreasing the quantity of VMs **2505** provided using resources of multiple devices **2500** and/or **2600** may require considerably less time, especially if such increases or decreases are effected by transferring VMs **2505** from use by one user or group of users to use by another user or group of users. Still further, and as will also be readily recognizable by those skilled in the art, increasing or decreasing quantities of pods **2661** and/or containers **2565** instantiated within VMs **2505** may require still less time, especially if the transferring of VMs **2505** between users or groups of users entails the performance of operations to clear associated memory spaces, to reset various operating parameters, and/or to alter what user and/or group of users is granted access thereto. Alternatively or additionally, where VMs **2505** are to be exchanged between users and/or groups of users, there may be a delay in such exchanges to wait for when a VM **2505** is no longer needed by one user or group of users such that it becomes available for being provided to another user or group of users. As part of a mechanism to mitigate such delays, it may be that the device data **2531** specifies a length of time and/or other factor(s) that may be employed to implement a degree of hysteresis in effecting a decrease in the quantity of VMs **2505** that may be made accessible to a particular user or group of users to allow for the possibility that the reduction in need for VMs **2505** may be relatively quickly followed by an increase in need for VMs **2505**.

[0662] Turning more specifically to FIG. 20D, and as previously discussed, it is envisioned that, in some embodiments, there may be a multitude of task types that enable advantage to be taken of various specialized resources that

may not be provided across all devices **2500** and/or **2600**, and/or even a majority of devices **2500** and/or **2600**. Such specialized resources may include newer forms of processing resource that may be prohibitively expensive to provide across more than a limited subset of device(s) **2500** and/or **2600**. Alternatively or additionally, such specialized resources may include data that may, by law, by contract, by physical limitations, etc., be available to just a limited subset of devices **2500** and/or **2600**, such as data sets of sensitive personal information (e.g., medical records subject to access restrictions under the health insurance portability and accountability act (HIPAA) in the United States, or under the general data protection regulation (GDPR) in the European Union). In such situations, it may be that at least a subset of the tasks of a job flow that requires access to such specialized resources must be performed within the limited subset of devices **2500** and/or **2600** in which such specialized resources are available.

[0663] In support of this, and as previously discussed, there may be a multitude of task types to enable advantage to be taken of various specialized processing resources (e.g., the depicted example GPU **2580** that federated devices **2500/2** may include, while other federated devices **2500/1** do not), and/or to enable advantage to be taken of access to various specialized federated areas **2566** that store particular objects (e.g., the depicted example federated areas **2566/2** that may store specially licensed data objects, in contrast to other federated areas **2566/1** that do not). As depicted, such specialized resources may be accessible only to a subset of task pods **2661/2** that may be designated as a separate type of task pod (e.g., the depicted task pods **2661/2** for “type 2”), and that may need to be instantiated within a limited subset of devices (e.g., the depicted federated devices **2500/2** for “type 2”), unlike the more common and/or more widely instantiated task pods **2661/1** (for “type 1”) that may be able to be instantiated more widely within a wider variety of devices, including both of the depicted types of federated devices **2500/1** and **2500/2**.

[0664] Alternatively, and as also depicted, where the resources of the depicted federated devices **2500/1** and **2500/2** are allocated through the instantiation of VMs **2505** (e.g., the depicted VMs **2505/2** and **2505/1**), it may be that task pods **2661/2** that support the execution of the depicted “type 2” task routines **2440/2** may need to be instantiated within one of the “type 2” VMs **2505/2** that are instantiated just within the federated device(s) **2500/2** that provide the particular specialized resource(s) required to support the performance of “type 2” tasks. To enable access to those specialized resource(s) available just within the “type 2” federated devices **2500/2**, the “type 2” VM(s) **2505/2** may be required to be specifically configured to provide access thereto, from within the “type 2” VM(s) **2505/2**, for executable routines that are executed therein, such as “type 2” task routines **2440/2** that are executed within “type 2” task containers **2565/2** within “type 2” task pods **2661/2**.

[0665] Turning to FIGS. 20E-F, in executing the message broker routine **2419**, the processor(s) **2550** of the federated device(s) **2500** may be caused to instantiate and maintain a set of message queues **2669** that, as depicted, may include a job queue **2669j**, a task queue **2669t**, a job kill queue **2669jk**, a task kill queue **2669tk** and/or a scaling queue **2669x**. As previously discussed, the message broker routine **2419** may be one that is selected for its ability to implement the widely used Advanced Message Queuing Protocol (AMQP), such

as RabbitMQ. In some embodiments, the messages that are exchanged may be generated to conform to any of a variety of types of format, including and not limited to a human-readable format such as JSON.

[0666] As depicted, each one of the different message queues **2669j**, **2669t**, **2669jk**, **2669tk** and **2669x** may be made accessible to and utilized by different subsets of the different types of pod **2661p**, **2661e**, **2661x**, **2661t** and **2661k**. More specifically, the job queue **2669j** may be accessible to and utilized by the portal pods **2661p** and the performance pods **2661e**; the task queue **2669t** may be accessible to and utilized by the performance pods **2661e** and the task pods **2661t**; the job kill queue **2669jk** may be solely accessible to and utilized by the portal pods **2661p**; the task kill queue **2669tk** may be accessible to and utilized by the portal pods **2661p**, the task pods **2661t** and the kill pod(s) **2661k**; and the scaling queue **2669x** may be accessible to and utilized by the performance pods **2661e** and the scaling pod **2661x**.

[0667] As previously discussed, in some embodiments, each of the different types of pod **2661** may be provided with various environment variables relevant to that type of pod **2661** when instantiated by the processor(s) **2550** under the control of the resource allocation routine **2411**. As also previously discussed, such environment variables may be made accessible to routines executed within container(s) **2565** within each of the types of pod **2661** through use of a callable query procedure. Thus, in some embodiments, it may be that such provision of environment variables may be used to provide each type of pod with environment variable (s) specifying the particular message queue(s) **2669** that each is to use for messaging communications. Within each such pod **2661**, the instance of the messaging routine **2414** therein may cause the use of the callable query procedure to (from within its container **2565**) request the provision of one or more environment variables that convey, to that instance of the messaging routine **2414**, an indication of what message queue(s) **2669** are to be used for messaging communications with the environment external to that pod **2661**.

[0668] As will be familiar to those skilled in the art, each such message queue **2669j**, **2669t**, **2669jk**, **2669tk** and **2669x** functions essentially as a set of storage spaces for the storage of messages. Thus, when a message is “output” onto the one of these queues **2669**, that message is actually being stored within that queue, and may remain stored therein until actively removed therefrom (or perhaps, until the queue’s capacity is reached such that earlier messages may be overwritten, unless the queue’s capacity is not fixed or is otherwise expandable to a degree based on available storage resources). This also applies where a message is said to be “exchanged” through one of these queues **2669**—it is “exchanged” in the sense that it is stored within one of these queues **2669** and is at least detected as being stored therein and accessed to retrieve its contents, and may then also be removed therefrom, although such removal may be a separate action such that it is not coincident with being accessed to read its contents. Again, and as will be explained in greater detail, many of the messages that may be output from various ones of the pods **2661** onto various ones of the message queues **2669** may not be specifically directed at another particular one of the pods **2661**. This is reflective of the fact that, in the middle of the performance of a job flow, one or more of the pods **2661** of any of the various types may be uninstantiated by the resource allocation routine **2411**.

Thus, it may simply not be possible to rely on any particular one of the pods **2661** to remain instantiated throughout the performance of a job flow. Stated differently, which pods **2661** are involved in different aspects of the performance of a job flow may change throughout the time that job flow is being performed, depending on which pods **2661** are instantiated and/or are available for use.

[0669] It should be noted that, while each of the queues **2669j**, **2669jk**, **2669t**, **2669tk** and **2669x** are depicted herein as single bi-directional queues, other embodiments are possible in which one or more of these queues may each be implemented as a pair of uni-directional queues. More specifically one queue of such a pair may be the queue by which messages originating from one type of pod are conveyed to one or more of another type of pod, while the other queue of such a pair provides the return path for responding messages to be conveyed in the other direction. Thus, by way of example, the job queue **2669j** may be implemented as a pair of queues where one conveys messages from the one or more portal pods **2661p** to the one or more performance pods **2661e**, while the other conveys messages in the reverse direction from the one or more performance pods **2661e** to the one or more portal pods **2661p**.

[0670] Alternatively or additionally, other embodiments are possible in which one or more of the queues **2669j**, **2669jk**, **2669t**, **2669tk** and **2669x** may be implemented as a set of queues that includes a single queue by which request messages may be conveyed to multiple recipients, and that includes multiple queues by which responding messages may be separately conveyed from separate ones of the multiple recipients (e.g., a single separate queue for each recipient). Thus, by way of example, the task queue **2669t** may include a single queue by which messages may be conveyed from the one or more performance pods **2661e** to the multiple task pods **2661t**, and multiple separate queues by messages from each task pod **2661t** may be separately conveyed to the one or more performance pods **2661e**.

[0671] Turning to FIG. 20G, each of the portal pods **2661p** may serve to provide a portal container **2565p** in which an instance of the portal component **2549** may be executed. As has been previously discussed, in executing the portal component **2549**, processor(s) **2550** of the federated device(s) **2500** may be caused to operate one or more of the network interfaces **2590** thereof to provide a portal accessible by other devices via the network **2999** (e.g., the source device (s) **2100** and/or the reviewing device(s) **2800**), and through which requests may be received to perform various operations, including the performance of job flows. With multiple instances of the portal component **2549** being separately executed in multiple portal containers **2565p** across multiple ones of the portal pods **2661p**, different cores **2555** of the processor(s) **2550** of the federated device(s) **2500** that execute different ones of the multiple instances of the portal component **2549** may be caused to share in maintaining the portal on the network **2999**, and/or in receiving and/or responding to requests from other devices to perform various operations.

[0672] Any of a variety of types of portal may be provided that may use any of a variety of types of protocol and/or applications programming interface (API). By way of example, the portal may be implemented as a secure webpage portal employing the hypertext transfer protocol over secure sockets layer (HTTPS) that requires the provi-

sion of a password and/or other security credentials. Alternatively or additionally, the portal may employ an implementation of representational state transfer (REST or RESTful) API. Also alternatively or additionally, the portal may be configured to receive requests to perform operations that have formatting, syntax and/or other characteristics selected to conform to one or more industry specifications for communications between devices, such as one or more of the versions of the Message-Passing Interface (MPI) specification promulgated by the MPI Forum, a cooperative venture by numerous governmental, corporate and academic entities.

[0673] Regardless of the exact manner in which a portal may be implemented, and/or what protocol(s) and/or API(s) may be used, execution of the instance(s) of the portal component 2549 may cause core(s) 2555 of the processor(s) 2550 of the federated device(s) 2500 to refer to indications stored within the portal data 2539 of what persons, entities and/or machines are authorized to be granted access to the various services that may be provided by the federated device(s) 2500, as has been previously discussed. Again, such indications may include indications of security credentials expected to be provided by such persons, entities and/or machines. In some embodiments, such indications within the portal data 2539 may be organized into a database of accounts that are each associated with an entity with which particular persons and/or devices may be associated. Security credentials presented by other devices across the network 2999 to the portal may be evaluated against such information stored within the portal data 2539 to determine whether access is to be granted.

[0674] Presuming access has been granted such that a request for a performance of a job flow is accepted from another device across the network 2999, then a record of details of the request, including the current status of the requested job flow performance, may be maintained within the request data 2535. In some embodiments, the request data 2535 may be implemented as a database to which access is shared by all of the instances of the portal component 2549 that are each being executed within a separate portal container 2565p within a separate portal pod 2661p. As will be explained in greater detail, the portal component 2549 may also (in cooperation with the selection component 2543 and/or the database component 2545 of the control routine 2540) employ whatever identifiers may have been provided in the request to retrieve identifier(s) of one or more objects needed for the requested performance of the job flow, and/or to retrieve one or more of such objects (e.g., the job flow definition 2220 of the requested job flow) from federated area(s) 2566. As will also be explained in greater detail, the portal component 2549 may further use whatever identifiers, and/or objects were received in the request and/or retrieved from federated area(s) 2566, in an exchange of messages through the job queue 2669j with an available one of the instances of the performance component 2544 being executed within a performance container 2565e of a performance pod 2661e to cause commencement of the requested performance of the job flow, and to monitor the status of that requested performance. Again, such exchanges with the job queue 2669j may be through the instance of the messaging routine 2514 that is executed within the corresponding messaging container 2565m.

[0675] In embodiments in which different types of pod 2661 are provided with various environment variables rel-

evant to that type of pod 2661 when instantiated, as discussed above, it may be that such environment variables provided to each portal pod 2661p may include an environment variable that species a maximum quantity of requests received from other devices that are able to be concurrently supported by each instance of the portal pod 2661p. Such an environment variable may be made accessible to the instance of the portal component 2549 executed within the portal container 2565p within each instance of the portal pod 2661p. In some of such embodiments, such an environment variable may be used, in conjunction with a specified maximum quantity of instances of the portal pod 2661p, as a mechanism to limit the overall quantity of received requests that are able to be concurrently supported by federated device(s) 2500 of the distributed processing system 2000.

[0676] Turning to FIG. 20H, each of the performance pods 2661e may serve to provide a performance container 2565e in which an instance of the performance component 2544 may be executed. As has been previously discussed, in executing the performance component 2544, processor(s) 2550 of the federated device(s) 2500 may be caused to: 1) coordinate the retrieval of the objects necessary to perform a job flow from federated area(s) 2566; 2) to derive an order of performance of the tasks of the job flow that is based on indications of dependencies among the tasks indicated in the flow definition 2225 of the job flow definition 2220, and that takes advantage of opportunities for parallel performances of tasks; and/or 3) coordinate the execution of the task routines 2440 to enact the performances of those tasks in the derived order.

[0677] As previously discussed, the message that is output by the instance of the portal component 2549 onto the job queue 2669j to convey the received request to perform a job flow may include a combination of object(s) retrieved from federated area(s) 2566 (e.g., the job flow definition 2220 of the requested job flow) and/or identifiers of further object(s) that are also to be retrieved from the federated area(s) 2566. In some embodiments, an available one of the instances of the performance component 2544 that accepts that message through the job queue 2669j may receive at least the job flow definition 2220 and/or an instance log 2720 that documents an instance of a past performance of the corresponding job flow 2200 directly from the message. However, in alternate embodiments, it may be that an available one of the instances of the performance component 2544 that accepts that message through the job queue 2669j uses whatever identifiers are provided in the message to, itself, obtain at least the job flow definition 2220 and/or such an instance log 2720.

[0678] As will also be explained in greater detail, that instance of the performance component 2544 may then exchange numerous messages with available task pods 2661t through the task queue 2669t to cause the executions of the task routines 2440 within those available task pods 2661t to thereby cause performances of the tasks of the job flow. That instance of the performance component 2544 may include, in such messages to task pods 2661t, one or more objects received and/or retrieved by the performance component 2544 (e.g., at least a portion of the job flow definition 2220), and/or may include one or more identifiers of objects that are to be retrieved from federated area(s) 2566 to enable the execution of task routines 2440 (e.g., the task routines 2440 and/or data objects used as inputs thereto). That

instance of the performance component **2544** may also exchange further messages with those task pods **2661t** through the task queue **2669t** to monitor the progress of those executions of task routines **2440**. Upon completion of the executions of all of those task routines **2440**, that instance of the performance component **2544** may output a message on the job queue **2669j** to an available instance of the portal component **2549** indicating the successful completion of the job flow. Again, such exchanges with the job queue **2669j** and/or the task queue **2669t** may be through the messaging routine **2514** that is executed within the corresponding messaging container **2565m**.

[**0679**] As also depicted in FIG. 20H, the scaling pod **2661x** may serve to provide a scaling container **2565x** in which a single instance of the scaling routine **2412** may be executed. The single instance of the scaling routine **2412** may receive messages from each of the instances of the performance component **2544** that are indicative of quantities of types of pod **2661** that are needed to support the performances of various job flows. These messages may be so received via a scaling queue **2669x** that, unlike the other previously discussed queues **2669**, may be implemented as a unidirectional publishing queue in which messages are only received by the scaling routine **2412** from the instances of the performance component **2544**.

[**0680**] As each of the instances of the performance component **2544** triggers the commencement of execution of each task routine **2440** to perform a task of a job flow, and/or as each of the instances of the performance component **2544** receives an indication of completion of execution of a task routine **2440** of a job flow, each of the instances of the performance component **2544** may transmit a message via the scaling queue **2669x** to the scaling routine **2412** to indicate what quantity of each type of pod **2661** is needed at that time to properly support the performances of job flows that are currently in the process of being performed through the execution of task routine(s) **2440** to perform the tasks thereof. As each such message is received by the scaling routine **2412**, it may combine the most recently received indications of requirements for quantities of types of pod **2661** received from each of the instances of the performance component **2544** to generate an aggregate indication of the needed quantities of types of pods **2661** to be provided as an input to the resource allocation routine **2411**.

[**0681**] As has been discussed, in embodiments in which VMs **2505** are used as part allocating resources, the scaling routine **2412** may also recurrently provide updated indications of needed quantities of VMs **2505** to the VM allocation component **2511**. In embodiments in which the VM allocation component **2511** is provided with information concerning maximum quantities of types of pod **2661** that are able to be supported within each VM **2505**, the VM allocation component **2511** may adjust the overall quantity of VMs **2505** based on the same indications of needed quantities of pods **2661** that are provided to the resource allocation routine **2411**. Alternatively, it may be that the scaling routine **2412** is provided with information concerning maximum quantities of types of pod **2661** that are able to be supported within each VM **2505**, and may use that information to provide recurrently updated indications of quantities of the VMs **2505** to the VM allocation component **2511**.

[**0682**] As has also been discussed, there may be multiple types of pod **2661**, each of which may be configured differently to better enable its use in supporting the execu-

tion of a different type of executable routine within one of its containers **2565**. In particular, in addition to the different types of pod **2661** that may be instantiated by the resource allocation routine **2411** to support the execution of the portal component **2549**, the performance component **2544**, the scaling routine **2412** and/or the kill routine **2415**, there may be multiple types of the task pod **2661t** having differing features to support the execution of task routines **2440** having different characteristics. By way of example, there may be different types of task pod **2661t** to support task routines **2440** written in different languages, and/or different types of task pod **2661t** to support task routines **2440** that use various different services (e.g., types that are provided with access to federated areas **2566** versus types that are not provided with such access).

[**0683**] Over time, there may occasionally be a need to alter the relative quantities of the portal pods **2661p**, the performance pods **2661e** and/or the task pods **2661t** to accommodate changing quantities of external devices **2100** or **2800** accessing objects stored within federated areas **2566**, changing quantities of job flows being performed, and/or changing quantities of task routines **2440** being executed. For example, it may be that the scaling routine **2412** receives messages from one or more instances of the performance component **2544** conveying a need to change the quantity of performance pods **2661e** that are needed to better support the performance of more or fewer job flows. Alternatively or additionally, over time, there may occasionally be a need to alter the relative quantities of the different types of task pod **2661t** as the particular combination of task routines that are executed change throughout the performance of one or more job flows. For example, it may be that the scaling routine **2412** receives messages from one or more instances of the performance component **2544** conveying a need for more task pods **2661t** that are configured to support the execution of task routines **2440** written in one language, and fewer task pods **2661t** that are configured to support the execution of task routines **2440** written in another language.

[**0684**] In some embodiments, such an ability to control the quantity of a particular type of task pod **2661t** may be employed to cause serialization of the execution of task routines **2440** of a corresponding particular type in which each such task routine **2440** is caused to be executed sequentially within the very same task pod **2661t**. This may be deemed desirable where, as previously discussed, a shared memory space **2665** has been instantiated as part of enabling two task routines that have been written in the same secondary language to more efficiently exchange one or more data objects therebetween. Again, as previously discussed, normal use of task pods **2661t** may likely result in one of those two task routines **2440** being executed within one task pod **2661t** and storing those data object(s) within a federated area **2566** in a process that may require one or more types of conversion to be performed thereon, followed by the other of those two task routines **2440** being executed within a different task pod **2661t** with those same data object(s) needing to be retrieved from that federated area **2566** in a process that may require the one or more conversions to be reversed. Again, the performances of both the conversion(s) and the corresponding reverse conversion(s) may consume considerable resources and time such that

being able to more directly exchange those same data object(s) between those two task routines **2440** may be deemed more desirable.

[0685] As previously discussed, resource allocation software, such as Kubernetes, is necessarily reactive to observations of the levels of utilization of various resources provided by computing device(s) as a result of the execution of routines within each of the pods **2661**. Unlike each of the instances of the performance component **2544**, which have access to and directly parse the contents of the job flow definitions **2220**, the resource allocation routine **2411** may have no such access to such indications of what the upcoming resource requirements will be, and/or may not have been written to take advantage of such information. By preemptively providing the resource allocation routine **2411** with such indications of such changing needs, the resource allocation routine **2411** is then given such insights such that it is able to act more proactively, instead of being limited to acting in response to its observations of the degree to which different types of pods **2661** have already been caused to be used more or used less, and/or the degree to which each pod **2661** of each type is being caused to consume more or fewer resources.

[0686] As previously discussed, in some embodiments, a relatively lengthy period of time may be required by the resource allocation routine **2411** to instantiate a particular type of pod **2661** when there isn't already at least one of that type of pod **2661** already currently instantiated. To at least limit the occasions on which such a lengthy time period must be incurred, there may be a hysteresis or other form of delay imposed on the scaling routine **2412** providing the resource allocation routine **2411** with an indication that none of a particular type of pod **2661** is needed such that the resource allocation routine **2411** may unstantiate all of that type of pod **2661**. Instead, the scaling routine **2412** may provide an initial indication to the resource allocation routine **2411** that only one of the particular type of pod **2661** is needed, before providing an indication that none of the particular type of pod **2661** are needed after the pre-selected delay.

[0687] To address the possibility that one of the performance pods **2661e** from which the scaling routine **2412** receives messages via the scaling queue **2669x** may be uninstantiated by the resource allocation routine **2411**, the information provided in each such message may be assigned a limited lifespan for being deemed valid by the scaling routine **2412**. More specifically, if information received from a particular one of the performance pods **2661e** is not updated with new information from the same performance pod **2661e** within a preselected threshold period of time, then the information last received that same performance pod **2661e** may be deemed invalid, and may no longer be taken into account in combining information from the performance pods **2661e** for being provided to the resource allocation routine **2411**. This may be based on a presumption that, following the un instantiation of one of the performance pods **2661e**, the remaining performance pods **2661e** would take over controlling the performance of whatever job flows were being controlled from the now un instantiated performance pod **2661e**, and that the information sent by one or more of the remaining ones of the performance pods **2661e** would begin to reflect the additional resource requirements of associated with effecting such a take over.

[0688] In embodiments in which different types of pod **2661** are provided with various environment variables rel-

evant to that type of pod **2661** when instantiated, as discussed above, it may be that such environment variables provided to each performance pod **2661e** may include an environment variable that specifies a maximum quantity of tasks of a job flow that may be executed in parallel. More specifically, in embodiments in which there may be multiple different types of task pod **2661t**, such environment variables provided to each performance pod **2661e** may include an environment variable that specifies a maximum quantity of tasks of a particular type corresponding to one of the types of task pod **2661t** that may be executed in parallel, such as tasks written in a particular programming language and/or that require the use of a particular relatively limited resource.

[0689] Alternatively or additionally, in embodiments in which different types of pod **2661** are provided with various environment variables relevant to that type of pod **2661** when instantiated, as discussed above, it may be that such environment variables provided to the scaling pod **2661x** may include an environment variable that specifies a minimum or maximum quantity of task pods **2661t**, and/or a minimum or maximum quantity of a particular type of task pod **2661t**, that may be maintained for use in executing task routines **2440**.

[0690] Turning to FIG. 20I, each of the task pods **2661t** may serve to provide a task container **2565t** in which an instance of a task routine **2440** retrieved from a federated area **2566** may be executed. As depicted, in addition to being instantiated to include a message container **2565m** within which an instance of the messaging routine **2414** is executed, each of the task pods **2661t** may be instantiated to also include a resolver container **2565r** in which an instance of the resolver routine **2413** may be executed to provide the ability to directly access federated area(s) **2566** to directly retrieve such objects as task routines **2440** and/or data objects to be used as input thereto. Such a retrieved task routine **2440** may then be executed within the task container **2565t** that is also included within each task pod **2661t**.

[0691] As previously discussed, any of a variety of types of request to perform a job flow may be received, and including requests that lead to the performance of the job flow with the most recent versions of task routines **2440** and requests that lead to the performance of the job flow with specific versions of task routines **2440** selected to match the versions used in a previous performance. Thus, a message received from a performance pod **2661e** via the task queue **2669t** to perform a task may include an identifier of the task to be performed and/or an identifier of the particular task routine **2440** that is to be executed to perform the task. Regardless of the particular identifier that is so provided, and as will be explained in greater detail, the corresponding instance of the resolver routine **2413** may use that identifier to access one or more federated areas **2566** to locate and retrieve a copy of an appropriate version of task routine **2440** needed for the requested task performance.

[0692] As will also be explained in greater detail, that task pod **2661t** may exchange further messages with that performance pod **2661e** to enable monitoring of the progress of execution of the retrieved task routine **2440** within that task pod **2661t**. Alternatively or additionally, that task pod **2661t** may transmit further messages indicative of the status of the execution of the task routine **2440** via the task kill queue **2669k** to a kill pod **2661k**. Such messages sent to the kill pod **2661k** may include indications of resources consumed,

elapsed time, instances of failure in execution of the task routine **2440** and/or efforts to re-attempt execution of the task routine **2440** to provide the kill pod **2661k** with information needed to make a determination as to whether or not the execution of the task routine **2440** exhibits one or more characteristics that may serve as the basis for ceasing the execution of at least the task routine **2440**, if not also ceasing the performance of the entire job flow. Again, such exchanges with the task queue **2669t** and/or the task kill queue **2669tk** may be through the messaging routine **2514** that is executed within the corresponding messaging container **2565m**.

[0693] In embodiments in which different types of pod **2661** are provided with various environment variables relevant to that type of pod **2661** when instantiated, as discussed above, it may be that such environment variables provided to each task pod **2661t** may include an environment variable that specifies which type of task pod **2661t** that each task pod **2661t** may have been instantiated to become. By way of example, in embodiments in which there is more than one type of task pod **2661t** based on which programming language is supported, it may be that an environment variable provided to each task pod **2661t** specifies the programming language(s) that are to be supported for task routines **2440** that are executed therein, and this may serve as the basis for which language interpretation capabilities are to be enabled therein.

[0694] Turning to FIG. 20J, the kill pod **2661k** may serve to provide a kill container **2565k** in which an instance of the kill routine **2415** may be executed. The kill routine **2415** may monitor the messages output by each of the task pods **2661t** onto the task kill queue **2669tk** (as discussed just above) to monitor the status of the execution of task routines **2440** within each of task pods **2661t**. More specifically, and by way of example, the kill routine **2415** may monitor for a series of messages from task pods **2661t** indicating that attempts to execute a particular task routine **2440** in connection with a particular job flow have failed a pre-selected quantity of times that meets a predetermined threshold quantity for triggering the cancellation of that job flow. Alternatively or additionally, and by way of another example, the kill routine **2415** may monitor for messages indicating that one or more aspects of the execution of a particular task routine **2440** in connection with a particular job flow has exceeded one or more limitations such that it can be presumed that the task routine cannot be successfully executed within those limitations, and so the associated job flow must be cancelled. Such limitations may include, and are not limited to, a maximum amount of time in which execution of a task routine is expected to be completed, a maximum level of consumption of a processing and/or storage resource, or a permitted range of behaviors of a task routine.

[0695] Regarding instances in which the execution of a task routine **2440** fails badly enough to cause a crash within a task container **2565t** of a task pod **2661t**, the messaging routine **2514** being executed in the corresponding messaging container **2565m** therein may be triggered to output a message onto the task kill queue **2669tk** indicating that execution of that task routine **2440** has ended with an error. This may be one of the messages that the kill routine **2415** monitors the task kill queue **2565t** for, and it may include an identifier of the task routine **2440** that crashed, of the task that was to be performed through execution of that task

routine **2440**, and/or the job flow identifier **2221** of the job flow **2200** that the attempted execution of that task routine **2440** is associated with. The output of such a message may then be followed by an uninstantiation of that task pod **2661t**, which may then trigger the resource allocation routine **2411** to instantiate a new task pod **2661t** as a replacement. It may be deemed desirable for a task pod **2661t** in which such a crash has occurred to be uninstantiated, rather than to attempt to use that same task pod **2661t** in re-attempting execution of the same routine or in executing another routine, as the crash that occurred therein may have adversely affected various aspects of the state of the task container **2565t** therein and/or of that task pod **2661t** such that unpredictable results may arise if that same task container **2565t** within that same task pod **2661t** is used again.

[0696] Upon observing messages on the task kill queue **2669tk** that indicate either 1) that the predetermined quantity of unsuccessful attempts have been made to execute a particular task routine **2440** associated with a particular job flow has occurred, or 2) that an attempt to execute the particular task routine **2440** associated with the particular job resulted in exceeding one or more limitations, further execution of the kill routine **2415** may cause core(s) **2555** of processor(s) **2550** of the one or more federated devices to respond by outputting a message onto the task kill queue **2669tk** that conveys a command to all task pods **2661t** in which any task routine **2440** is being executed to perform a task of that same job flow to cease any further execution of such task routines **2440**. Such a message may include the job flow identifier **2221** to specify that job flow.

[0697] Again, each of the task pods **2661t** may have access to the task kill queue **2669tk** in addition to having access to the task queue **2669t**. Each of the task pods **2661t** may monitor the task kill queue **2669tk** for such messages conveying such commands to cease the execution of various task routines **2440**. Upon detecting the output of the message by the kill routine **2415** to cease the execution of all task routines **2440** associated with that job flow, each of the task pods **2661t** in which such a task routine **2440** is currently being executed may: 1) cease such execution, 2) transmit a message onto the task queue **2669t** indicating the cessation of execution of the task routine **2440** for reasons of that execution having been commanded to be canceled, and 3) cause its own uninstantiation.

[0698] The receipt, by an instance of the performance component **2544** that is coordinating the performance of that job flow, of one or more of such messages from one or more of the task pods **2661t** indicating such cessation(s) of execution of task routine(s) associated with that job flow as a result of being commanded to do so, may cause that instance of the performance component **2544** to 1) cease to transmit any further messages to any task pods **2661t** to perform any more task routines **2440** in connection with that job flow, and 2) output a message via the job queue **2669j** to an available instance of the portal component **2549** indicating the cancellation of that job flow for reasons of errors having been encountered in attempting to perform it. That available instance of the portal component **2549** may relay such an indication onward to the device from which the request was received to perform it. Again, such exchanges with the task kill queue **2669tk** may be through the messaging routine **2414** that is executed within the corresponding messaging container **2565m**.

[0699] In embodiments in which different types of pod 2661 are provided with various environment variables relevant to that type of pod 2661 when instantiated, as discussed above, it may be that such environment variables provided to each kill pod 2661*k* may include environment variable(s) that specify one or more of the various conditions under which the kill routine 2415 may be triggered to cause the cessation of execution of a task routine 2440, and/or cause the cessation of performance of the entire associated job flow.

[0700] FIGS. 21A and 21B, together, illustrate various aspects of exchanging objects in an architecture employing both pod-based resource allocation and message-based coordination of MTC, such as the exemplary internal architecture of FIGS. 20A-J. More specifically, FIG. 21A depicts an example exchange of objects between the federated device (s) 2500 and a requesting device 2100 or 2800 in a pod-based environment while entirely circumventing the use of message-based coordination, and FIG. 21B depicts an example of a similar exchange in which some degree of message-based coordination may be used.

[0701] Turning to FIG. 21A, one of the one or more instances of the portal component 2549 may receive a request, through the network 2999 from a requesting device 2100 or 2800, to exchange object(s) with the federated device(s) 2500 in order to either store object(s) within a federated area 2566 or retrieve object(s) therefrom. As has been discussed, the instance of the portal component 2549 that receives this request may do so while being executed by core(s) 2555 of processor(s) 2550 within an portal container 2565*p* within a portal pod 2661*p* that was instantiated with a configuration that enables the instance of the portal component 2549 therein to have access to the network 2999, as well as to such external data structures as the portal data 2539 and/or the request data 2535 that may be shared with other similar instances of the portal component 2549. As has also been discussed, the same portal pod 2661*p* may have also been instantiated with a configuration to have a messaging container 2565*m* within which an instance of the messaging routine 2414 is executed to provide the instance of the portal component 2549 with access to the message queues 2669.

[0702] Upon receiving the exchange request, and as previously discussed, the determination may be made as to whether or not the request is authorized using information concerning authorized individual persons, individual machines, institutions, corporations, government agencies, etc. that is maintained within the portal data 2539. Presuming the exchange request is authorized, core(s) 2555 of processor(s) 2550 of the federated device(s) 2500 may be caused by execution of the portal component 2549 to generate an entry for the request within the request data 2535 that may include details of what is requested (in this example, an exchange of objects), identifier(s) of the objects to be exchanged and/or of the federated area 2566 to be involved in the exchange, and/or an indication of the current status of the request. As previously discussed in detail, such a request may directly refer to the one or more objects to be exchanged by their individual identifiers, and/or may indirectly refer to the one or more objects by referring with an identifier to a job flow or an instance log that documents the use of particular objects in a past performance of a particular job flow. As another alternative where the request is to store

one or more objects, the request, itself, may be accompanied by the one or more objects that are requested to be stored.

[0703] Following the storage of such an entry for the exchange request within the request data 2535, and following the storage of an indication therein that the requested exchange is in progress (e.g., a status indication of “running”), core(s) 2555 of processors 2550 may be caused by further execution of the instance of the portal component 2549 to transmit an indication of the “running” status of the requested exchange across the network 2999 to the requesting device 2100 or 2800. Beyond such a transmission of status, further execution of the instance of the portal component 2549 may cause core(s) 2555 of processor(s) 2550 to actually perform the requested exchange of object(s) between a federated area 2566 and the requesting device 2100 or 2800. As previously discussed in detail, the performance of such exchanges may entail the execution of instructions of the admission component 2542, the selection component 2543 and/or the database component 2545 to cause the performances of various aspects of the requested storage or retrieval of one or more objects. Again, such aspects may entail retrieving and/or generating various identifiers 2221, 2222, 2241, 2331, 2332, 2441, 2442, 2721, 2722, 2771 and/or 2772 to identify and/or locate objects to be retrieved, and/or to prepare for the storage of objects. In support of such exchanges, and of such cooperation among the instance of the portal component 2549, and each of the components 2542, 2543 and/or 2545, the portal pod 2661*p* may have also been instantiated with a configuration that enables such access to federated area(s) 2566 (as well as to the components 2542, 2543 and/or 2545) by the instance of the portal component 2549 therein. It may be that, as a result of having and using such relatively direct access to federated area(s) 2566, such a request to exchange objects may be referred to as a “direct request.”

[0704] As has been discussed, there is the possibility that ongoing execution of the resource allocation routine 2411 may cause the uninstantiation of the very same portal pod 2661*p* in which the instance of the portal component 2549 that is currently involved in the exchange of objects is executed. As a result, the requested exchange of objects may be interrupted, and this may occur with no coordination with any aspect of the performance of that exchange. The storage of the “running” status indication within the entry for the request within the request data 2535 may serve as an indicator to all currently existing instances of the portal component 2549 within their corresponding portal pods 2661*p* that there is an exchange objects that is in progress. Such a request entry with such a “running” status indication may include an identifier of the instance of the portal component 2949 (and/or of its portal pod 2661*p*) to thereby allow other instances of the portal component 2949 to monitor the status of the exchange. Such a “running” indication may also enable another instance portal component 2949 to take over the performance of the exchange where the “running” indication remains while the instance of the portal component 2949 that was originally involved in performing the exchange is uninstantiated. In this way, completion of the performance of the exchange is assured to occur, even if it has been interrupted and must be restarted.

[0705] Turning to FIG. 21B in addition to FIG. 21A, the instance of the portal component 2549 that originally received the exchange request and/or that stored the status indication of “running” within the request data 2535, may

cooperate with the messaging routine 2414 executed within the corresponding messaging container 2565_m to output a message 2434_{eo} indicating the receipt of a request to exchange objects onto the job queue 2669_j. This may be done either in addition to or in lieu of storing the aforementioned “running” indication within the request data 2535, and may be serve similar functions, including triggering the taking over of the performance of the exchange following an instantiation of the instance of the portal component 2549 that was involved in performing it. As will be familiar to those skilled in the art, a message queue (e.g., the depicted job queue 2669_j) may function as a set of storage locations where a protocol is employed concerning the output of messages onto the message queue, the monitoring the ongoing presence of messages on the message queue, and/or the removal of message from the message queue. Just as other instances of the portal component 2549 may monitor the ongoing presence of the earlier discussed “running” status indication within the request data 2535, other instances of the portal component 2549 may monitor the ongoing presence of the message 2434_{eo} on the job queue 2669_j.

[0706] Following the completion of the exchange of objects, where the “running” indication was stored within the entry for the exchange request within the request data 2535, further execution of the instance of the portal component 2549 that is currently involved in the exchange may cause that “running” indication to be replaced within an indication that the exchange has been completed. Alternatively, the request entry may simply be removed from the request data 2535. However, where the request reception message 2434_{eo} was output onto the job queue 2669_j, either in addition to or in lieu of the storage of the “running” indication within the request data 2535, further execution of the instance of the portal component 2549 that is currently involved in the exchange may cause the message 2434_{eo} to be removed from the job queue 2669_j. Through such undoing of either or both of the “running” status indication within the request data 2535 and the message 2434_{eo} from the job queue 2669_j, the possibility of an accidental triggering of another instance of the portal component 2549 to attempt to perform the same exchange of objects, again, is thereby prevented. Core(s) 2555 of processor(s) 2550 of the federated device(s) 2500 may then be caused by further execution of the instance of the portal component 2549 that was last involved in performing the exchange of objects may then transmit an indication of completion of the exchange via the network 2999 to the requesting device 2100 or 2800.

[0707] FIGS. 22A, 22B, 22C, 22D, 22E, 22F, 22G, 22H and 22I, together, illustrate various aspects of performing a job flow in an architecture employing both pod-based resource allocation and message-based coordination of MTC, such as the exemplary internal architecture of FIGS. 20A-I. More specifically, FIGS. 22A and 22B, together, depict aspects of receiving a request to perform the job flow, and of using messaging to trigger and ensure the performance of the job flow. FIGS. 22C, 22D, 22E and 22F, together, depict aspects of using messaging to monitor the performance of the job flow, while triggering and ensuring support for the execution of at least one task routine 2440 to cause the performance of at least one task of the job flow. FIGS. 22G, 22H and 22I, together, depict aspects of relaying indications of completion of the execution of a task and/or of completion of the performance of the job flow among

Pods 2661 and to the requesting device 2100 or 2800, as well as enabling reallocation of resources for other purposes.

[0708] Turning to FIG. 22A, one of the one or more instances of the portal component 2549 may receive a request, through the network 2999 from a requesting device 2100 or 2800, to perform a job flow. Again, the instance of the portal component 2549 that receives this request may be executed by core(s) 2555 of processor(s) 2550 within a portal container 2565_p within a portal pod 2661_p providing access to the network 2999, access to the portal data 2539 and/or the request data 2535, and/or relatively direct access (e.g., through the components 2542, 2543 and/or 2545) to federated area(s) 2566. And again, the same portal pod 2661_p may have also been instantiated to have a messaging container 2565_m within which an instance of the messaging routine 2414 is executed to provide the instance of the portal component 2549 with access to message queues 2669.

[0709] Again, upon receiving the job performance request, a determination may be made as to whether or not the request is authorized using information within the portal data 2539. Presuming the job performance request is authorized, core(s) 2555 of processor(s) 2550 of the federated device(s) 2500 may be caused by execution of the portal component 2549 to generate an entry for the request within the request data 2535 that may include details of what is requested (in this example, a performance of a job flow), identifier(s) of the job flow and/or of objects associated with a past performance of the job flow, and/or an indication of the current status of the request. As previously discussed in detail, such a request to perform a job flow may be one of a variety of previously discussed types of requests. By way of example, the request may be to perform a job flow with one or more specified data objects as input, and using the latest versions of tasks routines 2440 to perform the various tasks of the job flow. As has been discussed, it may be that the use of the latest versions of tasks routines 2440 in performing a job flow is the default, unless a request to perform a job flow specifies otherwise. An example of a request that includes such a contrary specification may be a request to repeat a particular past performance of a job flow using the very same versions of task routines 2440 as were used in that past performance, as well as the very same data objects as inputs as were used in that past performance. As has been explained, such a request may be made as part of enforcing accountability for the objects used and/or the results achieved in that past performance.

[0710] Following the storage of such an entry for the request to perform a job flow within the request data 2535, and following the storage of an indication therein that the requested job flow performance is running, core(s) 2555 of processors 2550 may be caused by further execution of the instance of the portal component 2549 to transmit an indication of status across the network 2999 to the requesting device 2100 or 2800 that the requested job flow performance is in progress (e.g., a status indication of “running”). Beyond such a transmission of status, further execution of the instance of the portal component 2549 may cause core(s) 2555 of processor(s) 2550 to gather further details required to bring about the requested performance. As was previously discussed, regardless of the exact type of request to perform a job flow that is received, there remains a need to retrieve various objects required to either perform that job flow or to provide the results of a past performance of that job flow. To effect such object retrievals, the relatively direct access that

each of the instances of the portal component **2549** are provided to federated area(s) **2566** (as described above in connection with FIGS. **21A-B**) may be used. Again, such object retrieval(s) may entail the execution of instructions of the admission component **2542**, the selection component **2543** and/or the database component **2545** to cause the performances of various aspects of the requested retrieval of one or more objects.

[**0711**] Following such retrieval(s) of a job flow definition **2220** and/or an instance log **2720**, and/or following the retrieval(s) of one or more identifiers, the instance of the portal component **2549** that originally received the job flow performance request and/or that stored the “running” indication within the request data **2535**, may cooperate with the identifier component **2541** to generate globally unique identifiers (GUIDs) for the instance of performance of the job flow that has been requested, and for each instance of performance of a task that is part of the job flow. More specifically, in executing the identifier component **2541**, processor(s) **2550** of the federated device(s) **2500** may be caused to generate a single job flow instance identifier **2701** for the instance of performance of the job flow that has been requested (and that is about to be caused to begin), and a separate task instance identifier **2704** for each instance of performance of a task that is to occur as part of performing the job flow.

[**0712**] Following the generation of the job flow instance identifier **2701** and the set of task instance identifiers **2704**, the same instance of the portal component **2549** may cooperate with the messaging routine **2414** executed within the corresponding messaging container **2565_m** to output, onto the job queue **2669_j**, a job flow performance request message **2434_{pj}** that conveys the instruction to perform the job flow. Where the originally received request was simply to perform a particular job flow with one or more particular data objects as input, the request message **2434_{pj}** may include a copy of the job flow definition **2220** for that job flow, along with data object identifier(s) **2331** of the data object(s) that were specified in the original request to be used as inputs. However, where the originally received request was to repeat a particular past performance of a particular job flow, the request message **2434_{pj}** may additionally include a copy of the instance log **2720** that documents that particular past performance. The job performance request message **2434_{pj}** may additionally include the job flow instance identifier **2701** and the set of task instance identifiers **2704**. Also, the job performance request message **2434_{pj}** may additionally include the federated area identifier (s) **2569** of each of the federated areas **2566** to which access is authorized.

[**0713**] Both the storage of the “running” indication within the request data **2535**, and the output of the request message **2434_{pj}** onto the job queue **2669_j** may serve similar functions in terms of ensuring that the job flow will be performed as requested, even if the instance of the portal component **2549** that received the original request is uninstantiated as a result of its portal pod **2661_p** being uninstantiated by the resource allocation routine **2411**. However, each of these actions may be of use in addressing such an uninstantiation occurring at different points in time. More specifically, as described just above, the storage of the “running” indication within the request data **2535** may occur relatively immediately after the receipt of the original request, and before the gathering of information needed to generate and output the request

message **2434_{pj}**. Thus, if the instance of the portal component **2549** that received the original request is uninstantiated at that point, another instance of the portal component **2549** would be able to rely on the “running” indication within the request data **2535** as providing an indication that there is still a job flow to be performed, and would be able to rely on the lack of the request message **2434_{pj}** having been output onto the job queue **2669_j** as serving as an indication that resumption of the performance of the job flow should begin with gathering whatever information may be needed from federated area(s) **2566** to generate the message **2434_{pj}**.

[**0714**] However, and turning to FIG. **22B**, if the instance of the portal component **2549** that received the original request is uninstantiated (as depicted with a dashed “X”) after the request message **2434_{pj}** has been output onto the job queue **2669_j**, then another instance of the portal component **2549** would be able to rely on the “running” indication within the request data **2535** and the fact of the request message **2434_{pj}** being present on the job queue **2669_j** as serving, together, as an indication that there is still a job flow to be performed, and that the request message **2434_{pj}** needed to trigger the performance thereof has already been generated and output onto the job queue **2669_j**. Thus, in this way, some amount of information concerning the state of the now uninstantiated instance of the portal component **2549** is preserved to be relayed to the instance of the portal component **2549** that takes over for it.

[**0715**] Turning to FIG. **22C**, as previously discussed, it may be that none of the messages that are output onto each of the message queues **2669** (e.g., the job queue **2669_j** that is specifically depicted in FIG. **22C**) are actually directed to any particular pod **2661** or any particular instance of a routine being executed within a pod **2661**. Instead, each of the messages may be directed to an available pod **2661** of a particular type in which an available instance of a type of routine is being executed within a container **2565** therein that could become involved in the performance of a job flow, or may be directed to whichever one of a type of pod **2661** is the one of that type of pod **2661** that contains an instance of a type of routine that is already involved in the performance of a job flow. Thus, and more specifically, the request message **2434_{pj}** that relays the request to perform the job flow may be meant to be received by whichever one of the performance pods **2661_e** happens to contain an instance of the performance component **2544** that is available to take on the controlling of the executions of individual task routines **2440** to thereby control the performances of the individual tasks of the job flow as part of actually effectuating the performance of the job flow.

[**0716**] As depicted, it may be that one of the performance pods **2661_e** does contain an instance of the performance component **2544** that is being executed within its performance container **2565_e**, and that is available to provide such control over such executions of task routines **2440**. As further depicted, in some embodiments, the available instance of the performance component **2544** may cooperate with the instance of the messaging routine **2414** within the corresponding messaging container **2565_m** to output a job in-progress message **2434_{jip}** onto the job queue **2669_j** that provides an indication that such per-task actions to effectuate the performance of the job flow are in progress, such that the “running” status indicated in the request data **2535** for this instance of performing the job flow is correct.

[0717] Again, it may be that the in-progress message **2434jip** is also not directed to any particular one of the portal pods **2661p**, but instead, is directed to whichever one of the portal pods **2661p** is the one that contains the instance of the portal component **2549** that is currently involved in the performance of the job flow. To do this, the in-progress message **2434jip** may include the job flow instance identifier **2701** and/or other identifier(s) to identify the job flow and/or the instance of its performance that is the subject of this message. Such an indirect approach to directing the in-progress message **2434jip** to a destination among the multiple portal pods **2661p** may be in recognition of the possibility that, following the output of the request message **2434pj** (to which the output of the job in-progress message **2434jip** is a response), the portal pod **2661p** from which the request message **2434pj** was output may have been uninstanced, and another instance of the portal component **2549** within another one of the portal pods **2661p** may have taken over in becoming involved in this instance of performing the job flow.

[0718] In embodiments in which the job in-progress message **2434jip** is output onto the job queue **2669j** as part of an instance of the performance component **2544** becoming involved in the performance of the job flow, the job in-progress message **2434jip** may serve the additional function of providing an indication that is able to be monitored by the other instances of the performance component **2544** that there is an instance of the performance component **2544** that has already become involved in the performance of the job flow, such that no other instance of the performance component **2544** needs to do so. Stated differently, the output of the job in-progress message **2434jip** may serve as a mechanism by which one of the instances of the performance component **2544** effectively “claims” the job flow that is requested to be performed in the request message **2434pj**.

[0719] It should again be noted that, in some embodiments, the job queue **2669j** may be implemented as a pair of side-by-side queues, where one conveys messages (e.g., the depicted request message **2434pj**) from the one or more portal pods **2661p** to the one or more performance pods **2661e**, and the other conveys messages (e.g., the depicted job in-progress message **2434jip**) from the one or more performance pods **2661e** to the one or more portal pods **2661p**.

[0720] Turning to FIG. 22D, in some of such embodiments, it may be that the job in-progress message **2434jip** by which the job flow is claimed includes an identifier of the instance of the performance component **2544** that made this claim. If that particular instance of the performance component **2544** is subsequently uninstanced (as depicted with a dashed “X”), then another instance of the performance component **2544** that is available to take over the performance of the job flow may be triggered to do so by the presence of the in-progress message **2434jip** on the job queue **2669j** that refers to the performance of the job flow as being in progress (as reflected with the “running” status indication discussed earlier as being stored in the request data **2535**), and which was under the control of an instance of the performance component **2544** that is no longer instanced.

[0721] Regardless of the exact manner in which an instance of the performance component **2544** claims the job flow so as to become involved in effectuating its performance, further execution of the instance of the performance

component **2544** may cause core(s) **2555** of processor(s) **2550** to analyze the job flow definition **2220** of the job flow to derive an order of execution of task routines **2440** to perform the various tasks of the job flow in a manner that takes advantage of opportunities to cause various subsets of the tasks to be performed at least partially in parallel. Upon deriving such an order of execution of task routines **2440**, that instance of the performance component **2544** may then cooperate with the instance of the messaging routine **2414** being executed within the corresponding messaging container **2565m** to output, onto the task queue **2669t** (i.e., store within the task queue **2669t**), a set of task routine execution request messages **2434et** that make requests for the execution of various task routines **2440** within available ones of the task pods **2661t**.

[0722] As depicted, each such task routine execution request message **2434et** may include an indication that the execution of a task routine **2440** is being requested, along with information needed to identify the task routine **2440** that is to be executed. Where the originally received request for a performance of the job flow did not specify that the performance is to be a repeat of a previous performance using specific versions of task routines **2440**, then the default of using the most recent version of each task routine **2440** may apply such that the task routine execution request message **2434et** may include the flow task identifier **2241** of the task that is to be performed through the execution of the most recent version of an appropriate task routine **2440**. In some embodiments, the flow task identifier **2241** may be conveyed within the message by including a portion of the job flow definition **2220** (e.g., the flow definition **2225**) for the job flow that includes just the flow task identifier **2241** of the task that is to be performed in response to the message. In such embodiments, it may be that the inclusion of a portion of the job flow definition **2220** within each task routine execution request message **2434et** is meant to cause each task routine execution request message **2434et** to essentially resemble a “slimmed down” version of the associated job performance request message **2434pj**. As previously discussed, in embodiments in which there may be multiple task types, the flow task identifier **2241** of the task that is to be performed may incorporate (or be otherwise accompanied by) a task type identifier **2242** that specifies the task type for that task.

[0723] However, where the originally received request for a performance of the job flow does specify that the performance is to be a repeat of a previous instance of a performance using specific versions of task routines **2440**, then the task routine execution request message **2434et** may include the task routine identifier **2441** of the specific version of the task routine **2440** that is to be executed. In embodiments in which there may be multiple task types, it may be that the task routine identifier **2441** of the specific task routine **2440** is accompanied by the task type identifier **2242** indicating the task type of that specific task routine **2440**.

[0724] Additionally, and regardless of the exact manner in which the task routine **2440** to be executed is identified, the task routine execution request message **2434et** may further include data object identifier(s) **2331** of any data objects that may be used as input, the job flow instance identifier **2701**, and/or the task instance identifier **2704** that uniquely identifies the instance of performance of the task that is being requested. Also, the task routine execution request message

2434_{et} may additionally include the federated area identifier (s) **2569** of each of the federated areas **2566** to which access is authorized.

[0725] Such task routine execution request messages **2434_{et}** may be stored within the task queue **2669_t** in an order and with timings that follow the derived order of execution so as to account for the dependencies among the tasks of the job flow. Stated differently, where opportunities exist to cause the execution of multiple task routines **2440** to occur at least partially in parallel, then the task routine execution request messages **2434_{et}** to cause such executions to occur may be stored on the task queue **2669_t** with little regard for when each is so stored within the task queue **2669_t** relative to the other(s). However, where the execution of an earlier task routine **2440** generates data that is needed as an input to the execution of a later task routine **2440**, then the output of the task routine execution request message **2434_{et}** to cause the execution of the later task routine **2440** may be delayed until a message **2434** indicating the completion of the execution of the earlier task routine **2440** (e.g., a completion message **2434_{tc}**, shortly to be discussed) has been detected as having been output onto (i.e., stored within) the task queue **2669_t**. Thus, in coordinating the executions of multiple task routines **2440** to follow the derived order of execution, core(s) **2555** of processor(s) **2550** may be caused by execution of the instance of the performance component **2544** to monitor the task queue **2669_t** for completion messages **2434_{tc}**, and may condition the output of a subset of task routine execution request message(s) **2434_{et}** on a subset of completion messages **2434_{tc}** being so stored within the task queue **2669_t**.

[0726] As previously discussed, the conditioning of the transmission of a task routine execution request message **2434_{et}** for the performance of a next task on the completion of performance of a preceding task that provides a data object needed as input to the next task may be one of the measures taken to effectuate a form of coherency of storage of data objects within federated areas. As will be explained in greater detail, implementing a requirement that a task completion message cannot be sent from a task pod **2661_t** unless and until all data objects generated during the execution of a task routine **2440** therein have been confirmed to have been stored in federated area(s) **2566** may be another measure taken to effectuate such coherency. As will also be explained in greater detail, still another of such measures may be delaying the commencement of execution of a task routine **2440** within a task pod **2661_t** until all data objects required as inputs thereto have been received at that task pod **2661_t**.

[0727] For sake of ease of understanding, FIG. 22D, and subsequent figures, depict the output of and responses to a single one of such task routine execution request messages **2434_{et}** onto the task queue **2669_t**. It should be noted that such a depiction of only a single one of the task routine execution request messages **2434_{et}** conveying a request for the execution of just a single task routine **2440** is meant to provide a deliberately highly simplified example so as to avoid unnecessary visual clutter as an aid to ease of understanding of what is depicted, discussed and claimed herein, and should not be taken as limiting what is described and claimed herein as being applicable only to such simplistic circumstances. Indeed, it is envisioned that what is depicted, discussed and claimed herein is to be used with job flows that include numerous tasks to be performed, thereby caus-

ing the execution of numerous corresponding task routines **2440**, and perhaps numerous instances of numerous task routines **2440** in the case in which one or more data objects may be distributed across multiple devices—and not just a single task causing the execution of a single instance of a single task routine **2440**, as depicted in subsequent figures.

[0728] In a manner somewhat like the earlier described output of the request message **2434_{pj}** onto the job queue **2669_j**, the output of the task routine execution request message **2434_{et}** onto the task queue **2669_t** may serve to ensure that the corresponding task routine **2440** will be executed as requested, even if the instance of the performance component **2544** that claimed control the job flow (e.g., by outputting the in-progress message **2434_{jip}**), and that output the task routine execution request message **2434_{et}**, is uninstantiated as a result of its performance pod **2661_e** being uninstantiated by the resource allocation routine **2411**. More specifically, if the instance of the performance component **2544** that claimed control over the job flow is uninstantiated (as depicted with a dashed “X”) after outputting the task routine execution request message **2434_{et}** onto the task queue **2669_t**, then another instance of the performance component **2544** would be able to rely on the task routine execution request message **2434_{et}** being present on the task queue **2669_j** as serving as an indication that there is still a task routine **2440** to be executed, and that the request message needed to trigger the execution thereof has already been generated and output onto the task queue **2669_t**. Thus, in this way, some amount of information concerning the state of the now uninstantiated instance of the performance component **2544** is preserved to be relayed to a new instance of the performance component **2544** that has taken over for the now uninstantiated instance.

[0729] Turning to FIG. 22E, in addition to transmitting the job in-progress message **2434_{jip}** on the job queue **2669_j**, and in addition to transmitting the task routine execution request message **2434_{et}** on the task queue **2669_t**, the same available instance of the performance component **2544** may also transmit a scale-up message **2434_{xu}** on the scaling queue **2669_x** for receipt at the single scaling pod **2661_x**. The scale-up message **2434_{xu}** may provide an indication of a need to increase the allocation of (or to at least forestall decreasing the allocation of) one or more type(s) of task pod **2661_t** that will be needed to execute the task routine(s) **2440** that will now be needed as a result of the performance of the job flow that the instance of the performance component **2544** is now involved in controlling. Again, in some embodiments, there may be different task types among the tasks that may be performed as part of performing a job flow, and again, the task routine execution request message **2434_{et}** may specify a type for the task that is to be performed by executing a task routine **2440**, as requested by that message. As also previously discussed, it may be that, for each task type, there may be a corresponding different type of task container **2665_t** instantiated within a corresponding different type of task pod **2661_t**.

[0730] As previously discussed in reference to FIGS. 20A-B and 20G, a scaling routine **2412** executed within a scaling container **2565_x** within the scaling pod **2661_x** may combine such messages from each of the instances of the performance component **2544** to generate a combined indication of quantities of various types of pods **2661** (including quantities of each of various types of task pod **2661_t** in embodiments in which there is more than one type) that are

currently needed, and may provide that combined indication to the resource allocation routine **2411**. Again, this is meant to provide the resource allocation routine **2411** with a preemptive indication of the quantities of various types of pods **2661** that are needed, rather than allowing the resource allocation routine **2411** to remain dependent on taking action to allocate types of pods **2661** as a reaction to observations of degree of use of the different types of pods **2661**.

[0731] However, as also previously discussed, the scaling routine **2412** may be provided with an indication that a reduced quantity of a particular type of task pod **2661t** supporting a secondary language is needed as a mechanism to cause two sequentially executed task routines **2440** written in the secondary programming language to be executed within the same task pod **2661t** so that a shared memory space **2665** may be used to exchange data object(s) therebetween. Thus, a “scale-down” message (not depicted) would be output onto the scaling queue **2669x**, rather than the depicted “scale-up” message **2434xu**, at least initially. After the sequential executions of such a pair of tasks has been performed a “scale-up” message **2434xu** may be output onto the scaling queue **2669x** to cause a return of the quantity of the particular type of task pod **2661t** back to its earlier higher level.

[0732] Again, as previously discussed, a data object output by a task routine **2440** written in a secondary programming language that is not normally used (or is not normally expected to be used) may have various formatting and/or organizational features that differ from an equivalent data object output by task routine **2440** written in a primary programming language that is normally used. As also previously discussed, where it is deemed desirable to store such a data object in a federated area **2566**, it may be that data objects that are so stored may be expected to have formatting and/or other organizational features conforming to those of data objects output by task routines **2440** written in the primary programming language. As a result, a data object output by a task routine **2440** written in a secondary programming language may be required to be subjected to one or more types of conversion before it can be stored in a federated area **2566**, and unfortunately, would have to be subjected to a reversal of such type(s) of conversion upon being retrieved therefrom for use as an input to another task routine that is also written in the secondary programming language, thereby incurring an excessive use of resources and time that may be avoided through the use of such a shared memory space **2665**.

[0733] Turning to FIG. 22F, as previously discussed, the task routine execution request message **2434et** that relays the request to execute a task routine **2440** as part of performing the job flow may be meant to be received by whichever one of the task pods **2661t** happens to be available for use in so executing the task routine **2440**. As depicted, it may be that one of the task pods **2661t** is so available, and may “claim” the task execution that is requested by outputting a task in progress message **2434tip** onto the task queue **2669t**. Again, it should be noted that in embodiments in which there are multiple federated devices **2500** and/or multiple storage devices **2600** that are configured to provide processing resources, it may be that there are task pods **2661t** instantiated by the resource allocation routine **2411** across multiple interconnected devices. Thus, the depicted one of the task pods **2661t** that happens to be

available for use in executing the task routine **2440** may be instantiated on any one of multiple devices.

[0734] Alternatively or additionally, and as also previously discussed, in embodiments in which there may be multiple different task types, the task execution request message **2343et** may additionally include a task type identifier **2242**. Again, this enables the task type to be readily identified to enable just task pods **2661t** of the correct corresponding type to quickly determine whether to “claim” the task execution requested by the task routine execution request message **2434et**. Thus, it may be that the one of the two depicted task pods **2661t** that claims the requested task execution by outputting the task in progress message **2434tip** is of the correct corresponding type, while the other one of the two depicted task pods **2661t** is not of the correct corresponding type such that it ignores the task routine execution request message **2434tip**, even if it might be available to execute a task routine **2440**.

[0735] As also depicted, in some embodiments, it may be the instance of the messaging routine **2414** within the messaging container **2565m** of the available task pod **2661t** that outputs the task in-progress message **2434tip** onto the task queue **2669t** that confirms that the execution of the task routine is in progress, such that the status of the performance of the corresponding task of the job flow is a “running” status. Again, it may be that the task in-progress message **2434tip** is also not directed to any particular one of the performance pods **2661e**, but instead, is directed to whichever one of the performance pods **2661e** is the one that contains the instance of the performance component **2544** that is currently involved in the performance of the job flow. To do this, the task in-progress message **2434tip** may include the job flow instance identifier **2701**, the task instance identifier **2704** for the task, and/or other identifier(s). Again, such an indirect approach to directing the task in-progress message **2434tip** to a destination among the multiple performance pods **2661e** may be in recognition of the possibility that, following the output of the task routine execution request message **2434et** (to which the output of the task in-progress message **2434tip** is a response), the performance pod **2661e** from which the task routine execution request message **2434et** was output may have been uninstanced, and another instance of the performance component **2544** within another one of the performance pods **2661e** may have taken over in becoming involved in controlling the performance of the job flow.

[0736] In embodiments in which the task in-progress message **2434tip** is output onto the task queue **2669t** as part of a task pod **2661t** becoming involved in the execution of task routine **2440** to perform a task of the job flow, the task in-progress message **2434tip** may serve the additional function of providing an indication that is able to be monitored from the other task pods **2661t** that there is a task pod **2661t** that is already in use to execute the task routine **2440**, such that no task pod **2661t** is needed to do so. Stated differently, the output of the task in-progress message **2434tip** may serve as a mechanism by which one of the task pods **2661t** effectively “claims” the task routine **2440** that is requested to be executed in the task routine execution request message **2434et**.

[0737] In some of such embodiments, it may be that the task in-progress message **2434tip** that claims the task routine **2440** additionally includes an identifier of the task pod **2661t** that made this claim. If that particular task pod **2661t** is

subsequently uninstantiated (as depicted with a dashed “X”), then another task pod **2661t** that is available for use executing the task routine **2440** may be triggered to do so by presence of the task in-progress message **2434tip** on the task queue **2669t** that refers to the execution of the task routine **2440** associated with the job flow as being in progress within the task container **2565t** of a task pod **2661t** that is no longer instantiated.

[0738] Regardless of the exact manner in which a task pod **2661t** claims the task routine **2440** as one that it will be involved in executing, the instance of the resolver routine **2413** being executed within the resolver container **2565r** therein may use the information provided in the task routine execution request message **2434et** concerning the task routine **2440** to be executed, along with any information concerning data objects to be used as inputs, to obtain the task routine **2440** and/or other objects needed to effectuate the execution thereof from one or more federated areas **2566**. In so doing, the resolver routine **2413** may use information provided in the task routine execution request message **2434et** concerning what federated area(s) **2566** are authorized to be accessed to limit searches for each of these objects to those particular federated area(s) **2566**. In some embodiments, the resolver routine **2413** may cooperate with the admission component **2542**, the selection component **2543** and/or the database component **2545** to retrieve each needed object in a manner similar to the cooperation between the portal component **2549** and these same components **2542**, **2543** and **2545** that was previously described in reference to FIGS. 21A-B. However, other embodiments are possible in which the resolver routine **2413** may perform such retrievals of objects more autonomously. Regardless of the manner in which the task routine **2440** that is to be executed, along with other needed objects, are retrieved from federated area(s) **2566**, upon being so retrieved, the task routine **2440** may then be executed within the task container **2565t**.

[0739] It should again be noted that, in some embodiments, the task queue **2669t** may be implemented as a set of side-by-side queues, where one queue conveys messages (e.g., the depicted task routine execution request message **2434et**) from the one or more performance pods **2661e** to the multiple task pods **2661t**, and multiple others that each convey messages (e.g., the depicted task in-progress message **2434tip**) from a separate one of the multiple task pods **2661t** to the one or more performance pods **2661e**. Further, while the one queue that conveys messages from the one or more performance pods **2661e** to the multiple task pods **2661t** may be continuously maintained, as will shortly be explained in greater detail, it may be that each one of the multiple other queues conveying messages back to the one or more performance pods **2661e** is maintained temporarily for while each corresponding one of the task pods **2661t** is engaged in the execution of a task routine **2440**. Stated differently, each of the multiple other queues may be instantiated to exist for just the duration of execution of a task routine **2440** within the corresponding task pod **2661t**, and may then be uninstantiated when such execution ends.

[0740] Turning to FIG. 22G, upon completion of the execution of the task routine **2440**, from the task pod **2661t**, a completion message **2434tc** indicating such completion of execution of the task routine **2440** may be output onto the task queue **2669t**. Such a completion message **2434tc** may be directed at whichever one of the instances of the perfor-

mance component **2544** within one of the performance pods **2661e** is the instance that is currently controlling the execution of task routines **2440** as part of effectuating the performance of the job flow. To enable this, the completion message **2434tc** may include the job flow instance identifier **2701** and/or the task instance identifier **2704** for the task.

[0741] In some embodiments, the same task pod **2661t** in which execution of the task routine **2440** has been completed and from which the completion message **2434tc** message may have been output, may also act to “accept” the task routine execution request message **2434et**, thereby removing it from the task queue **2669t**. Alternatively, it may be the instance of the performance component **2544** that is currently controlling the execution of task routines **2440** for the job flow that so “accepts” the task routine execution request message **2434et**, thereby removing it from the task queue **2669t**, and may do so in response to the output of the completion message **2434tc**. In various embodiments, the accepting of the task routine execution request message **2434et** to remove it from the task queue **2669t** and/or the output of the completion message **2434tc** onto the task queue **2669t** may serve as another mechanism to again preserve an indication of the current state of the performance of the job flow, including the fact of completion of the task routine **2440**, if the instance of the performance component **2544** that is currently controlling the execution of task routines **2440** for the job flow is uninstantiated.

[0742] Presuming there are no other task routines **2440** that need to be executed as part of performing the job flow, then upon receipt of the completion message **2434tc**, the instance of the performance component **2544** that is currently controlling the execution of task routines **2440** for the job flow may be caused (in cooperation with its corresponding instance of the messaging routine **2414**) to output a completion message **2434jc** indicating completion of the performance of the job flow onto the job queue **2669j**. Such a completion message **2434jc** may be directed at whichever one of the instances of the portal component **2549** within one of the portal pods **2661p** is the instance that is currently involved in the performance of the job flow. To enable this, the completion message **2434jc** may include the job flow instance identifier **2701**.

[0743] In some embodiments, the same instance of the performance component **2544** from which the completion message **2434jc** message may have been output, may also act to “accept” the request message **2434pj**, thereby removing it from the job queue **2669j**. Alternatively, it may be the instance of the portal component **2549** that is currently involved in the performance of the job flow that so “accepts” the request message **2434pj**, thereby removing it from the job queue **2669j**, and may do so in response to the output of the completion message **2434jc**. In various embodiments, the accepting of the request message **2434pj** to remove it from the job queue **2669j** and/or the output of the completion message **2434jc** onto the job queue **2669j** may serve as another mechanism to again preserve an indication of the current state of the performance of the job flow, including the fact of completion of the job flow, if the instance of the portal component **2549** that is currently involved in the performance of the job flow is uninstantiated.

[0744] Turning to FIG. 22H, upon receipt of the completion message **2434jc**, the instance of the portal component **2549** that is currently involved in the performance of the job flow may be caused to update the indication of the status of

the job flow performance stored within the entry within the request data **2535** from an indication of “running” to an indication of being “completed” (or, may simply remove the entry for the job flow, altogether). The same instance of the portal component **2549** may also transmit an indication of completion of this instance of performing the job flow via the network **2999** to the requesting device **2100** or **2800**.

[0745] Turning to FIG. **22I**, in addition to transmitting the completion message **2434jc** on the job queue **2669j**, that same controlling instance of the performance component **2544** may also transmit a scale-down message **2434xd** on the scaling queue **2669x** for receipt at the single scaling pod **2661x**. The scale-down message **2434xd** may provide an indication of a reduced need for the allocation of the type(s) of task pod **2661t** that were needed to execute the task routine(s) **2440** of the now completed job flow. In this way, an indication is provided to the scaling routine **2412** that more task pods **2661t** of various types may now be allocated to enable the execution of other task routine(s) of other job flows, and/or that more pods **2661** of still other types may now be allocated to enable the execution of still other types of executable routine.

[0746] FIGS. **23A**, **23B** and **23C**, together, illustrate various aspects of recovery from multiple unsuccessful attempts at executing a task routine **2440** as part of performing a job flow in an architecture employing both pod-based resource allocation and message-based coordination of MTC, such as the exemplary internal architecture of FIGS. **20A-I**. More specifically, FIG. **23A** depicts aspects of a situation in which repeated attempts may be made to execute a task routine **2440** that each end in failure, followed by the kill routine **2415** being triggered to cause cessation of further attempts. FIGS. **23B** and **23C**, together, depict aspects of the manner in which, through the message-based coordination, the message output by the kill routine **2415** propagates to cause a corresponding cessation of further efforts to perform any other portion of the job flow, and to reflect the occurrence of an error to a requesting device **2100** or **2800**.

[0747] Turning to FIG. **23A**, it may be that an error condition exists within a particular task routine **2440** and/or within a job flow that employs the task routine **2440** to perform a task thereof such that none of repeated attempts to execute the same task routine **2440** have resulted in a successful completion of the performance of the corresponding task. More specifically, it may be that each attempt at executing the task routine **2440** within a task container **2565t** within a task pod **2661t** has resulted in the crashing of at least the task routine **2440**, which would typically also cause a corresponding crash of (or other form of halting of) the task container **2565t**.

[0748] It is recognized that the causes for at least some instances of failure for a task routine **2440** to successfully execute may be transient circumstances that may not be specific to the task routine **2440**, itself, or to the job flow with which the execution of the task routine **2440** is associated. By way of example, hardware and/or software failures within ones of the federated devices **2500** and/or ones of the storage devices **2600** may occur, and/or failures in communications between such devices may occur. Further, despite the presence of various devices, protocols and/or systems to provide some degree of redundancy to overcome such failures, there can still be instances where the execution

of routines can still be adversely affected for at least a brief period before recovery from such failures can be fully effectuated.

[0749] As a result, it may be that such an exemplary internal architecture as presented in FIGS. **15A-G** incorporates the ability to counteract such failures so as to enable the successful performance of job flows in spite of such failures. More specifically, where a crash arising from an attempt to execute a task routine **2440** occurs within a task pod **2661t**, core(s) **2555** of processor(s) **2550** may be caused by ongoing execution of the resource allocation routine **2411** to respond by uninstating that task pod **2661t**, and then instantiating a new task pod **2661t** as a replacement (though doing so may be delayed depending on changing levels of availability of resources). Execution the crashed task routine **2440** may be re-attempted within a new task pod **2661t** or an existing task pod **2661t** that becomes available. As previously discussed in reference to FIG. **22F**, the presence of a task routine execution request message **2434et** on the task queue **2669t** that conveys the request to execute the task routine **2440** may serve as the trigger to cause such a re-attempting thereof.

[0750] However, while such a mechanism to cause the execution of a task routine **2440** to be re-attempted following a crash may be effective in addressing an occasional failure in execution that is not caused by an error within a task routine **2440** and/or within a job flow that requires its execution, such a mechanism may be ill suited to a situation in which there is such an error within a task routine **2440** and/or within a job flow that requires its execution. It may be that an endless loop of re-attempting to execute the task routine **2440** results, which may consume valuable resources and lead to a situation where the performance of the associated job flow is never completed with either a favorable or unfavorable result.

[0751] To address such a situation, the instance of the messaging routine **2414** within the messaging container **2565m** within each task pod **2661t** may respond to an occurrence of a crash of a task routine **2440** within the task container **2565t** by outputting a message **2434tf** indicating failure in the execution of the task routine **2440** onto the task kill queue **2669tk**. Within the kill pod **2661k**, the instance of the kill routine **2415** being executed within the kill container **2565k** thereof may monitor the task kill queue **2669tk** (through the instance of the messaging routine **2414** executed within the messaging container **2565m** therein) for instances of such task failure messages **2434tf**. Each such task failure message **2434tf** may include the job flow identifier **2221**, the task routine identifier **2441** and/or other identifiers to identify the task routine **2440** that crashed and/or the job flow that required the execution of the task routine.

[0752] In some embodiments, core(s) **2555** of processors **2550** may be caused by ongoing execution of the kill routine **2415** to count the quantities of task failure messages **2434tf** that are associated with each job flow or that are associated with each combination of job flow and a particular task routine **2440**. Where one of such counts associated with a job flow reaches a predetermined maximum count threshold for execution failures, a kill tasks message **2434kt** may be output from the kill pod **2661k** onto the task kill queue **2669tk** to convey an instruction to cease any further execution of any task routine **2440** where such execution is associated with the job flow for which the maximum thresh-

old count was reached. Again, as discussed in reference to other messages, the kill tasks message **2434kt** is not addressed to any one particular task pod **2661t**, but is instead addressed to all task pods **2661t/k** in which a task routine **2440** is being executed in connection with the specified job flow.

[0753] Turning to FIG. 23B, in response to the output of the kill tasks message **2434kt**, each such task pod **2661t** in which such an execution of a task routine **2440** is currently underway may cease such execution, and from each such task pod **2661t**, a message **2434t/k** indicative of the cancellation of execution of the task routine **2440** therein may be output onto the task queue **2669t**. Each such task cancellation message **2434t/k** may include the job flow identifier **2221** that identifies the job flow with the execution of the canceled task **2440** was associated. Each such task cancellation message **2434t/k** may also include an indication that the reason for such cancellation is that the job flow has been requested to be canceled due to a detected recurring error in attempts to execute one of the task routines **2440**. Upon receipt of one or more of such task cancellation messages **2434t/k**, the instance of the performance component **2544** within its corresponding one of the performance pods **2661e** may respond by ceasing to cause any more executions of task routines **2440** associated with the job flow to occur, and may output a job flow cancellation message **2434j/k** onto the job queue **2669j**. The job flow cancellation message **2434j/k** may include the job flow identifier **2221** of the job flow.

[0754] Turning to FIG. 23C, in response to the output of the job flow cancellation message **2434j/k**, the instance of the portal component **2549** that is currently involved in the performance of the job flow may update the indication of status of the performance of the job flow within the request data **2535** from an indication that the performance is underway to an indication that the performance has been canceled. That same instance of the performance component **2549** may also cause the transmission, to the requesting device **2100** or **2800** that had originally requested the performance of the job flow, an indication that the performance has been canceled due to an error having been encountered.

[0755] FIGS. 24A, 24B, 24C and 24D, together, illustrate various aspects of effecting a requested cancellation of a performance of a job flow in an architecture employing both pod-based resource allocation and message-based coordination of MTC, such as the exemplary internal architecture of FIGS. 20A-I. More specifically, FIG. 24A depicts aspects of the receipt of a request from a requesting device to cancel a performance of a job flow that had earlier been requested to be performed. FIGS. 24B, 24C and 24D, together, depict aspects of the manner in which, through the message-based coordination, a message that is output to cause a cessation of executions of tasks of the job flow leads to a cessation of other aspects of the performance of the job flow.

[0756] Turning to FIG. 24A, one of the one or more instances of the portal component **2549** may receive a request, through the network **2999** from a requesting device **2100** or **2800**, to cancel a previously requested performance of a job flow. It should be noted that such a request to cancel a performance of a job flow may be received an handled by a different one of the instances of the portal component **2549** than the instance that is currently monitoring the performance of the job flow, as previously requested. To ensure that the cancellation is performed in spite of the possibility of the instance of the portal component **2549** that received the

cancellation request being uninstigated, that instance of the portal component **2549** may output a kill job flow message **2434kj** onto the job kill queue **2669jk**.

[0757] Turning to FIG. 24B, following such outputting of the kill job flow message **2434kj** on to the job kill queue **2669jk**, that same instance of the performance component **2549** may then output a kill tasks message **2434kt** onto the task kill queue **2669tk**. This kill tasks message **2434kt** may be very similar to the kill tasks message **2434kt** earlier described in reference to FIG. 24A as being output by the kill routine **2415** inasmuch as the kill tasks message **2434kt** may specify that all execution of task routines **2440** within task pods **2661t** must cease where the execution of those tasks is associated with the performance of the job flow that is requested to be canceled.

[0758] Turning to FIG. 24C, the response to the output of the kill tasks message **2434kt** may be very much like what was described in reference to FIG. 24B. Again, each such task pod **2661t** in which such an execution of a task routine **2440** is currently underway may cease such execution, and from each such task pod **2661t**, a message **2434t/k** indicative of the cancellation of execution of the task routine **2440** therein may be output onto the task queue **2669t**. Each such task cancellation message **2434t/k** may include the job flow identifier **2221** that identifies the job flow with the execution of the canceled task **2440** was associated. Each such task cancellation message **2434t/k** may also include an indication that the reason for such cancellation is that the job flow has been requested to be canceled. Upon receipt of one or more of such task cancellation messages **2434t/k**, the instance of the performance component **2544** within its corresponding one of the performance pods **2661e** may respond by ceasing to cause any more executions of task routines **2440** associated with the job flow to occur, and may output a job flow cancellation message **2434j/k** onto the job queue **2669j**. The job flow cancellation message **2434j/k** may also include the job flow identifier **2221** of the job flow.

[0759] Turning to FIG. 24D, the response to the output of the job flow cancellation message **2434j/k** may be very much like what was described in reference to FIG. 24C. Again, the instance of the portal component **2549** that currently oversees the performance of the job flow may update the indication of status of the performance of the job flow within the request data **2535** from an indication that the performance is underway to an indication that the performance has been canceled. That same instance of the performance component **2549** may also cause the transmission, to the requesting device **2100** or **2800** that had originally requested the performance of the job flow (which may or may not be the same requesting device **2100** or **2800** from which the request to cancel the performance was received), an indication that the performance has been canceled due to a request to do so. Further, the instance of the portal component **2549**, whether it is the same instance that also oversaw the performance of the job flow, or not, may remove the kill job flow message **2434kj** from the job kill queue **2669jk**.

[0760] FIGS. 25A, 25B, 25C and 25D, together, illustrate various aspects of generating a job flow for providing a requested view of an object in an architecture employing both pod-based resource allocation and message-based coordination of MTC, such as the exemplary internal architecture of FIGS. 20A-I.

[0761] Turning to FIG. 25A, one of the one or more instances of the portal component **2549** may receive a

request, through the network 2999 from a requesting device 2100 or 2800, to provide a view of an object, such as a data object (e.g., a data set 2330 or 2370, or a result report 2770), a task routine 2440, a job flow definition 2220 or an instance log 2720. Again, the instance of the portal component 2549 that receives this request may be executed by core(s) 2555 of processor(s) 2550 within a portal container 2565_p within a portal pod 2661_p. The portal pod 2661_p may be instantiated to provide access to the network 2999, access to the portal data 2539 and/or the request data 2535, and/or relatively direct access (e.g., through the components 2542, 2543 and/or 2545) to federated area(s) 2566. And again, the same portal pod 2661_p may have also been instantiated to have a messaging container 2565_m within which an instance of the messaging routine 2414 is executed to provide the instance of the portal component 2549 with access to message queues 2669.

[0762] Upon receiving the view request, a determination may be made as to whether or not the request is authorized using information within the portal data 2539. Presuming the view request is authorized, core(s) 2555 of processor(s) 2550 of the federated device(s) 2500 may be caused by execution of the portal component 2549 to generate an entry for the request within the request data 2535 that may include details of what is requested (in this example, the provision of a view of an object), identifier(s) of the object for which a view is to be provided, and/or an indication of the current status of the request. Such a request may directly refer to the object for which a view is to be provided by one or more identifiers associated with it.

[0763] Following the storage of such an entry for the view request within the request data 2535, and following the storage of an indication therein that the requested provision of a view is in progress (e.g., a status indication of “running”), core(s) 2555 of processors 2550 may be caused by further execution of the instance of the portal component 2549 to transmit an indication of the “running” status of the view request across the network 2999 to the requesting device 2100 or 2800. Beyond such a transmission of status, further execution of the instance of the portal component 2549, along with other components of the control routine 2540, may cause core(s) 2555 of processor(s) 2550 to retrieve one or more objects to generate and provide the requested view of the one object specified in the request. More specifically, what object(s) need to be retrieved to enable the generation and provision of the requested view depends on what single object is specified in the request, and/or what object(s) are included in the request. By way of example, where the view is to be of a single task routine 2440 or a single data object, then what is retrieved may be limited to the retrieval of the single specified object from a single federated area 2566 (unless the specified object is actually included in the view request). However, where the view is to be of a job flow 2200 (as described in a job flow definition 2220), or is to be of a particular instance of a performance of a job flow 2200 (as documented in an instance log 2720), what is retrieved may be multiple objects from one or more federated areas 2566.

[0764] As previously discussed, the retrieval of objects from federated area(s) 2566 may entail the execution of instructions of the admission component 2542, the selection component 2543 and/or the database component 2545 of the control routine 2540. Again, this may also entail retrieving various identifiers 2221, 2222, 2241, 2331, 2332, 2441,

2442, 2721, 2722, 2771 and/or 2772 to retrieve objects and/or to identify further objects to be retrieved. Again, in support of performing such operations, each of the portal pods 2661_p may have been instantiated with a configuration that enables such access to federated area(s) 2566 (as well as to the components 2542, 2543 and/or 2545) by the instance of the portal component 2549 therein.

[0765] As also previously discussed, the generation and provision of a view of an object may entail executing instructions of the interpretation component 2547 and/or the interaction component 2548 of the control routine 2540 by processor(s) 2550 of the federated device(s) 2500. Among the initial operations that are caused to be performed during execution of the interpretation component 2547 may be performing an analysis to determine whether one or more specialized resources that are accessible to just a subset of devices 2500 and/or 2600 need to be used to fulfill the view request. In executing the interpretation component 2547 to perform such an analysis, processor(s) 2550 may be caused to identify and interpret executable instructions and/or comments conforming to the syntax of one or more preselected programming languages, and/or to identify and interpret data types of data values and/or data structure types of data structures into which data values may be organized.

[0766] By way of example, fulfilling the view request may entail generating a view of a data object, which may entail accessing data values therein and/or to data structure(s) used to organize those data values, which may require the use of such a resource. More specifically, it may be that the contents of that data object are compressed and/or encrypted in a manner requiring access to resource(s) within just a subset of federated device(s) 2500 to decompress and/or decrypt those contents. Alternatively, it may be that the data values of a data set are of a specialized data type or encoding that is needed for use with a particular processing component (e.g., a particular GPU or particular neuromorphic device) such that access is needed to that specialty processing component to enable reading and interpretation of those data values. As previously discussed, a data object 2330, 2370 or 2770 may include metadata 2338 that may include an indication (e.g., a task type identifier 2242) of whether that data object was generated to be compatible with a task type that requires such a limited access resource. Alternatively or additionally, and as also previously discussed, a file name or other identifier of the data object 2330, 2370 or 2770 may include such an indication.

[0767] By way of another example, fulfilling the view request may entail generating a view of a task routine 2440, which may entail interpreting executable instructions and/or various inline comments therein, which may require the use of such a resource. More specifically, it may be that the executable instructions and/or comments are written in a manner that is meant for use with a particular processing component (e.g., a particular GPU or particular neuromorphic device) and/or a particular library of callable functions that are available within just a subset of federated device(s) 2500. As previously discussed, a task routine 2440 may include inline comments 2448 that may include an indication (e.g., a task type identifier 2242) of whether that task routine 2440 is executable to perform a task of a task type that requires such a limited access resource. Alternatively or additionally, and as also previously discussed, a file name or other identifier of task routine 2440 may include such an indication.

[0768] By way of still another example, fulfilling the view request may entail generating a view of a job flow 2200, which may entail interpreting the contents of the job flow definition 2220 for that job flow, which may provide indications that one or more of the tasks may be of a task type that requires the use of such a resource. As previously discussed, the flow definition 2225 of a job flow definition 2220 may specify the tasks to be performed using flow task identifiers 2241, and each of the flow task identifiers 2241 may include a corresponding task type identifier 2242 that provides an indication of the task type of the corresponding task.

[0769] Thus, as can be appreciated from the above examples, the exact nature of the analysis that is performed to determine whether one or more of such specialized resources are needed to fulfill the view request may differ depending on the type of object that is analyzed.

[0770] Where such analysis reveals that no such specialized resources are required to fulfill the view request, then the generation and provision of the requested view to the requesting device 2100 or 2800 via the network 2999 may be handled as a “direct request” in which just components of the control routine 2540 (e.g., the interpretation component 2547 and/or the interaction component 2548) need be executed (in a manner similar to what was discussed in reference to FIGS. 21A-B). Stated differently, under such circumstances, no use need be made of MTC including pods 2661 and/or containers 2565 instantiated therein.

[0771] Thus, upon determining that no such specialized resources are needed to fulfill the view request, processor(s) 2550 execute at least the interpretation component 2547 to generate the requested view of the specified object. Where the specified object is a data object 2330, 2370 or 2770, processor(s) 2550 may be caused to generate, from data values within that object, any of a variety of graphs that may have been requested from data values within the data object. Where the specified object is a task routine 2440, processor (s) 2550 may be caused to generate a DAG 2270 depicting aspects of that task routine 2440, such as the example DAG 2270 depicted in FIG. 19B. Where the specified object is a job flow 2200, processor(s) 2550 may be caused to generate a larger DAG 2270 depicting aspects of multiple tasks of the job flow 2200 and/or multiple corresponding task routines 2440 that may be executed to cause those multiple tasks to be performed (e.g., the example DAG 2270 depicted in FIG. 19D). Regardless of the type of view generated and/or what object(s) are depicted therein, upon completion of the generation of the request view, that completed view may then be transmitted back to the requesting device 2100 or 2800 via the network 2999.

[0772] As has been discussed, there is the possibility that ongoing execution of the resource allocation routine 2411 may cause the un instantiation of the very same portal pod 2661p in which the instance of the portal component 2549 that is currently involved in the generation and provision of the requested view is executed. As a result, the generation and/or provision of the requested view may be interrupted, and that this may occur with no coordination with any aspect of that performance. The storage of the “running” status indication within the entry for the request within the request data 2535 may serve as an indicator to all currently existing instances of the portal component 2549 within their corresponding portal pods 2661p that there is a generation and/or provision of a requested view of an object that is in progress.

Such a request entry with such a “running” status indication may include an identifier of the instance of the portal component 2949 (and/or of its portal pod 2661p) to thereby allow other instances of the portal component 2949 to monitor the status thereof. Such a “running” indication may also enable another instance portal component 2949 to take over the generation and/or provision of the requested view. In this way, completion of the generation and/or provision of the requested view is assured to occur, even if it has been interrupted and must be restarted.

[0773] However, in some embodiments, in addition to or in lieu of storing an indication of the “running” status within the request data 2535, and in a manner somewhat similar to what was depicted in FIG. 21B for storing an indication of the “running” state in a message, the instance of the portal component 2549 that originally received the exchange request and/or that stored the status indication of “running” within the request data 2535, may cooperate with the messaging routine 2414 executed within the corresponding messaging container 2565m to output a message 2434vo indicating the receipt of a request for a view of an object onto the job queue 2669j. As will be familiar to those skilled in the art, a message queue (e.g., the depicted job queue 2669j) may function as a set of storage locations where a protocol is employed concerning the output of messages onto the message queue, the monitoring the ongoing presence of messages on the message queue, and/or the removal of message from the message queue. Just as other instances of the portal component 2549 may monitor the ongoing presence of the earlier discussed “running” status indication within the request data 2535, other instances of the portal component 2549 may monitor the ongoing presence of the message 2434vo on the job queue 2669j.

[0774] Following the completion of the generation and provision of the requested view, and where the “running” indication was stored within the entry for the exchange request within the request data 2535, further execution of the instance of the portal component 2549 that is currently involved in fulfilling the view request may cause that “running” indication to be replaced within an indication that the exchange has been completed. Alternatively, the request entry may simply be removed from the request data 2535. However, where the request reception message 2434vo was output onto the job queue 2669j, either in addition to or in lieu of the storage of the “running” indication within the request data 2535, further execution of the instance of the portal component 2549 that is currently involved in the exchange may cause the message 2434vo to be removed from the job queue 2669j. Through such undoing of either or both of the “running” status indication within the request data 2535 and the message 2434vo from the job queue 2669j, the possibility of an accidental repeat of generating and providing the requested view is thereby prevented. An indication of completion of the fulfillment of the view request may then be transmitted to the requesting device 2100 or 2800 via the network 2999.

[0775] However, and turning to FIG. 25B, where the determination is made that a specialized resource associated with a particular task type is needed to fulfill the view request, the same instance of the portal component 2549 may cooperate with the messaging routine 2414 executed within the corresponding messaging container 2565m to output, onto the job queue 2669j, a job flow generation request message 2434/j1 that conveys the instruction to

generate a job flow for the generation of the requested view of the specified object. Where the originally received request specified an object already stored in a federated area 2566, the request message 2434jg1 may include an identifier of the object for use in enabling its retrieval from a federated area 2566. However, where the originally received request included the specified object, the request message 2434jg1 may include a copy of the specified object. The job flow generation request message 2434jg1 may additionally include a job flow instance identifier 2701 generated to uniquely identify this job of generating a job flow. The job flow generation request message 2434jg1 may further include an indication of the task type that is associated with the specialized resource(s) that are needed, and/or the federated area identifier(s) 2569 of each of the federated areas 2566 to which access is authorized.

[0776] Both the storage of the “running” indication within the request data 2535, and the output of the job flow generation request message 2434jg1 onto the job queue 2669j may serve similar functions in terms of ensuring that the job of generating a job flow will be performed as requested, even if the instance of the portal component 2549 that received the original request is uninstantiated as a result of its portal pod 2661p being uninstantiated by the resource allocation routine 2411.

[0777] Turning to FIG. 25C, again, it may be that none of the messages that are output onto each of the message queues 2669 (e.g., the job queue 2669j that is specifically depicted) are actually directed to any particular pod 2661 or any particular instance of a routine being executed within a pod 2661. Instead, each of the messages may be directed to an available pod 2661 of a particular type in which an available instance of a type of routine is being executed within a container 2565 therein that could become involved in the performance of a job flow, or may be directed to whichever one of a type of pod 2661 is the one of that type of pod 2661 that contains an instance of a type of routine that is already involved in the performance of a job flow. Thus, and more specifically, the job flow generation request message 2434jg1 that relays the request to generate a job flow may be meant to be received by whichever one of the performance pods 2661e happens to contain an available instance of the performance component 2544.

[0778] As depicted, it may be that one of the performance pods 2661e does contain an instance of the performance component 2544 that is available to provide such control over the generation of a job flow for generating a view of an object. As further depicted, in some embodiments, the available instance of the performance component 2544 may cooperate with the instance of the messaging routine 2414 within the corresponding messaging container 2565m to output a job flow generation in-progress message 2434gip1 onto the job queue 2669j that provides an indication that such generation of such a job flow is in progress, such that the “running” status indicated in the request data 2535 for this instance of performing the job flow is correct.

[0779] Again, it may be that the in-progress message 2434gip1 is also not directed to any particular one of the portal pods 2661p, but instead, is directed to whichever one of the portal pods 2661p is the one that contains the instance of the portal component 2549 that is currently involved in the job flow to generate a job flow. To do this, the in-progress message 2434gip1 may include the job flow instance identifier 2701 and/or other identifier(s) to identify the job flow

that is being performed to generate a job flow, and/or the instance of its performance that is the subject of this message. Again, such an indirect approach to directing the in-progress message 2434gip1 to a destination among the multiple portal pods 2661p may be in recognition of the possibility that, following the output of the request message 2434jg1, the portal pod 2661p from which the request message 2434jg1 was output may have been uninstantiated, and another instance of the portal component 2549 within another one of the portal pods 2661p may have taken over in becoming involved in this instance of performing the job flow to generate a job flow.

[0780] In embodiments in which the job flow generation in-progress message 2434gip1 is output onto the job queue 2669j as part of an instance of the performance component 2544 becoming involved in the performance of the job flow, the in-progress message 2434gip1 may serve the additional function of providing an indication that is able to be monitored by the other instances of the performance component 2544 that there is an instance of the performance component 2544 that has already become involved in the performance of the job flow to generate a job flow, such that no other instance of the performance component 2544 needs to do so. Stated differently, the output of the generate job flow in-progress message 2434jip may serve as a mechanism by which one of the instances of the performance component 2544 effectively “claims” the job of generating a job flow that is requested to be performed in the request message 2434jg1, and therefore, this in-progress message 2434gip1 may also include an identifier of the instance of the performance component 2544 that made this claim.

[0781] Turning to FIG. 25D, and regardless of the exact manner in which an instance of the performance component 2544 claims the job flow to generate a job flow so as to become involved in effectuating its performance, further execution of the instance of the performance component 2544 may cause core(s) 2555 of processor(s) 2550 to cooperate with the instance of the messaging routine 2414 being executed within the corresponding messaging container 2565m to quite simply relay the job flow generation request 2434jg1 onto the task queue 2669t as the depicted 2434jg2. Unlike a situation in which a job flow is to be performed, the generation of a job flow does not entail the execution of a set of tasks where the order of performance of those tasks needs to be derived. Instead, and as will shortly be explained, it will be within one of the task pods 2661t where much of the work of generating a job flow for generating a view of an object will be performed, and therefore, it may be sufficient to simply relay the job flow generation request message 2434jg1 onward to a task pod 2661t. In a manner somewhat like the earlier described output of the request message 2434jg1 onto the job queue 2669j, the relaying of that same request message onto the task queue 2669t as the request message 2434jg2 may serve to ensure that the requested generation of a job flow will take place, even if the instance of the performance component 2544 that claimed control of the job flow and relayed that same request message is uninstantiated as a result of its performance pod 2661e being uninstantiated by the resource allocation routine 2411.

[0782] Turning to FIG. 25E, as previously discussed, the job flow generation request message 2434jg2 that relays the request to generate a job flow for generating the requested view of the specified object may be meant to be received by

whichever one of the task pods **2661t** happens to be available for use in so executing the task routine **2440**. However, as also previously discussed, where a particular task type is specified, then whichever task pod **2661t** is available for use may be additionally required to be a task pod **2661t** that is configured for the same task type. Thus, as also previously discussed, the request message **2434jg2** relayed onto the task queue may additionally include a task type identifier **2242** to thereby enable the task type to be readily identified at each task pod **2661t** to enable the task pods **2661t** of the correct task type to quickly determine whether to “claim” the job flow generation request message **2434jg2**. As depicted in this example, it may be that one of the task pods **2661t2** is so available and is configured for the correct task type (i.e., “type 2” as opposed to the depicted task pod **2661t1** of “type 1”). Thus, it may be that the depicted task pod **2661t2** “claims” the job flow generation request **2434jg2** by outputting a job flow generation in progress message **2434gip2** onto the task queue **2669t**.

[0783] Again, it may be that the in-progress message **2434gip2** output onto the task queue **2669t** is also not directed to any particular one of the performance pods **2661e**, but instead, is directed to whichever one of the performance pods **2661e** is the one that contains the instance of the performance component **2544** that is currently involved in the generation of a job flow. To do this, the job flow generation in-progress message **2434gip2** may include the job flow instance identifier **2701**, and/or other identifier (s). The job flow generation in-progress message **2434gip2** may serve the additional function of providing an indication that is able to be monitored from the other task pods **2661t** that there is a task pod **2661t2** that is already in use to generate the requested job flow, such that no other task pod **2661t** is needed to do so. To do so, it may be that the in-progress message **2434gip2** additionally includes an identifier of the depicted task pod **2661t2**.

[0784] Turning to FIG. 25F, within the depicted task container **2565t2** within the task pod **2661t2**, an instance of an interpretation routine **2417t2** that is configured for the correct task type may interpret the contents of the specified object for which a view was requested to be generated. Again, the originally received view request may have specified any of a variety of objects, including, as depicted, a data object **2330**, **2370** or **2770**, a task routine **2440**, a job flow definition **2220** that describes a job flow **2200**, or an instance log **2720** that documents a performance of a job flow **2200**.

[0785] As previously discussed, had the interpretation component **2547** of the control routine **2540** been able to be used in conjunction with the interaction component **2548** to simply directly generate the requested view of the specified object (i.e., had there been no association with a task type that necessitated access to a particular resource), then the requested view would simply have been so generated (as discussed in connection with FIG. 25A). There would have been no need to involve the depicted instance of the interpretation routine **2417t2**, which is instantiated within the depicted task container **2565t2**, which is instantiated within the depicted task pod **2661t2**, which is instantiated within the depicted federated device **2500t2** that provides access to a particular resource needed to enable interpretation of the contents of the specified object. However, since such access to a particular resource is necessary, it is the depicted instance of the interpretation routine **2417t2** that is executed to interpret the contents of the specified object, and for the

purpose of generating the depicted job flow definition **2220t2** that describes a job flow **2200t2** for generating the requested view of the specified object, instead of participating in generating that requested view, directly.

[0786] As also previously discussed, and as also depicted, the particular resource that is so required may be any of a variety of items that the depicted particular federated device **2500t2** is able to provide access to. By way of example, the particular resource may be a restricted data object **2330r**, **2370r** or **2770r** that may be made accessible to just the federated device **2500t2** as a result of a license agreement (where such a licensing restriction may be enforced by being stored in a restricted federated area **2566r** to which just the federated device **2500t2** may have access). By way of another example, the particular resource may be a particular neuromorphic device **2570** or GPU **2580** that is directly incorporated into the federated device **2500t2**. By way of still another example, the particular resource may be decryption or decompression hardware component (not shown) that is directly incorporated into the federated device **2500t2**, or may be an executable routine for performing decryption or decompression (not shown) that may be licensed for execution within just the federated device **2500t2**.

[0787] Thus, depending on the what the particular resource is, the interpretation routine **2417t2** may use that particular resource in any of a variety of ways. By way of example, the particular resource may be used to make the contents of the specified object accessible to enable interpretation thereof (e.g., decompress, decrypt, normalize data formats, retrieve data values from data structures, etc.). By way of another example, the particular resource may be used to perform various operations on data values within the specified object to generate other data values required for the requested view (e.g., derive statistical using specialized capabilities of a specialized processing component, etc.); etc. By way of still another example, that particular resource may, itself, the specified object (e.g., is data with restrictive access, such as medical data subject to privacy laws), and the interpretation routine **2417t2** may access data values thereof and/or perform various operations therewith to generate other data values that summarize and/or characterize the contents thereof (e.g., a survey).

[0788] As previously discussed, a job flow definition **2220** may include both a flow definition **2225** that specifies tasks that are to be performed when the corresponding job flow **2200** is performed, and GUI instructions **2229** that may be executed to provide a GUI that is to be presented when the corresponding job flow **2200** is performed. Depending on the type of view that is requested, what the specified object is, and/or what the particular resource is, the job flow definition **2220t2** that is generated within the depicted container **2565t2** may include either or both of a flow definition **2225** that specifies tasks to be performed or GUI instructions **2229** that are to be executed when the corresponding job flow **2200t2** is subsequently performed to generate the requested view of the specified object. By way of example, where the view includes a graph that is to be generated, it may be that the job flow definition **2220t2** is caused to include GUI instructions **2229** that are executable to generate that graph. Alternatively or additionally, where the generation of the requested view requires access to the particular resource, it may be that the flow definition **2225** identifies at least one task to be performed that is of the task type that is associated with the particular resource.

[0789] Where there may be a need to perform various analyses and/or derivations of values based on data values stored in data object(s) 2330, 2370 and/or 2770, such that there are various data type conversions, normalization operations, statistical analyses, etc. that need to be performed as a set of tasks, it may be that, in some embodiments, a set of pre-selected task routines 2440 that each perform a selected analytical or normalization task may be stored within a federated area 2566. Such a set of pre-selected task routines 2440 may be so stored to provide a baseline set of functions that are able to be used in various combinations in support of generating views of at least data objects 2330, 2370 and/or 2770.

[0790] In addition to being provided access to the particular resource, depending on what the specified object is, generating the job flow definition 2220r2 may require access to one or more other object(s) stored within one or more federated areas 2566. More specifically, where the specified object is a job flow definition 2220 or instance log 2720, there may be a need to retrieve task routines 2440 that perform one or more of the tasks specified in the job flow definition 2220 and/or that are specifically identified in the instance log 2720. Alternatively or additionally, there may be a need to retrieve data objects that are to be used as inputs to the corresponding job flow 2200, and/or that have been used as inputs to and/or have been generated by a performance of the corresponding job flow 2200.

[0791] Turning to FIG. 25G, upon completion of the generation of the job flow 2220r2, a completion message 2434gc1 indicating such completion of the generation of the job flow 2220r2 may be output onto the task queue 2669r. Such a completion message 2434gc1 may be directed at whichever one of the instances of the performance component 2544 within one of the performance pods 2661e is the instance that is currently controlling the generation of the job flow 2220r2 as part of enabling the generation of the requested view of the specified object. To enable this, the completion message 2434gc1 may include the job flow instance identifier 2701 of the job to generate the job flow definition 2220r2.

[0792] As depicted, upon receipt of the completion message 2434gc1, the instance of the performance component 2544 that is currently controlling the generation of the job flow 2220r2 may be caused (in cooperation with its corresponding instance of the messaging routine 2414) to, at least effectively, relay the completion message 2434gc1 onto the job queue 2669j as the depicted completion message gc2. The completion message 2434gc2 may be directed at whichever one of the instances of the portal component 2549 within one of the portal pods 2661p is the instance that is currently involved in fulfilling the request for a view of the specified object through the generation of the job flow definition 2220r2. To enable this, the completion message 2434gc2 may also include the job flow instance identifier 2701.

[0793] Turning to FIG. 25H, upon receipt of the completion message 2434gc2, the instance of the portal component 2549 that is currently involved in fulfilling the original request for a view of the specified object may be caused to now use the just generated job flow definition 2220r2 to cause the generation of the requested view of the specified object. Doing so may entail the storing of a more typical job performance request message 2434jp (see FIG. 22A) to cause the performance of the job flow that is defined by the

job flow definition 2220r2 through use of the process depicted and described in reference to FIGS. 22A-I.

[0794] Following completion of that job flow performance, including the reception of the corresponding job completion message 2343jc (see FIG. 22H), the instance of the portal component 2549 that is involved, at that time, in fulfilling the original request for a view of the specified object may be caused to update the indication of the status of the view request stored within the entry within the request data 2535 from an indication of “running” to an indication of being “completed” (or, may simply remove that entry, altogether). The same instance of the portal component 2549 may also transmit an indication of completion of fulfilling the view request via the network 2999 to the requesting device 2100 or 2800, along with the requested view.

[0795] In some embodiments, it may be deemed desirable to store a copy of the newly generated job flow 2220r2 in a federated area 2565 to either enable its re-use, or to enable an evaluation thereof at a later time for sake of accountability, especially if it should be deemed to be defective in some way in fulfilling its purpose of generating the view that was requested. Alternatively, in other embodiments, it may be deemed a waste of resources to store a copy of such an automatically generated job flow definition that serves does nothing more than to generate a view.

[0796] FIGS. 26A and 26B, together, illustrate an example embodiment of a logic flow 3100. The logic flow 3100 may be representative of some or all of the operations executed by one or more embodiments described herein. More specifically, the logic flow 3100 may illustrate operations performed by the processor(s) 2550 in executing the control routine 2540, and/or performed by other component(s) of at least one of the federated devices 2500.

[0797] At 3110, a processor of a federated device of a distributed processing system (e.g., at least one processor 2550 of one of the federated devices 2500 of the distributed processing system 2000) may receive a request from a device, via a network (e.g., one of the source devices 2100, or one of the reviewing devices 2800, via the network 2999) and through a portal provided by the processor for access to other devices via the network, to add a new federated area to be connected to a specified existing federated area. As has been discussed, such a portal may employ any of a variety of protocols and/or handshake mechanisms to enable the receipt of requests for various forms of access to the federated area by other devices, as well as to exchange objects with other devices, via the network.

[0798] At 3112, in embodiments in which the federated device(s) that provide federated area(s) also control access thereto, the processor may perform a check of whether the request is from an authorized device and/or from an authorized person or entity (e.g., scholastic, governmental or business entity) operating the device that is an authorized user of the specified federated area (as well as for any related base federated area and/or any related intervening federated area), and/or has been granted a level of access that includes the authorization to make such requests. Again, the processor may require the receipt of one or more security credentials from devices and/or users from which such requests are received. If, at 3112, the processor determines that the request is not from an authorized device and/or is not from a person and/or entity authorized as a user with sufficient access to make such a request, then the processor may

transmit an indication of denial of the request to the device from which the request is received via the network at **3114**.

[0799] However, if at **3112**, the processor determines that the request is authorized, then at **3120**, the processor may allocate storage space within the one or more federated devices, and/or within one or more storage devices under the control of the one or more federated devices, for the requested new federated area that is connected to (e.g., branches from) the specified existing federated area.

[0800] At **3130**, the processor may generate a new global federated area identifier (GUID) that is to be used to uniquely identify the new federated area (e.g., a new global federated area identifier **2569**). At **3132**, the processor may add an indication of the creation of the requested new federated area, as well as the manner in which the requested new federated area is connected to the specified existing federated area to a federated area database that may store indications of the existence of each federated area, which users and/or devices are granted access to each, and/or how each federated area may be connected or otherwise related to one or more others (e.g., within the portal data **2539** and/or the federated area parameters **2536**). In so doing, the new federated area, the specified existing federated area and/or other federated areas may be identified and referred to within such databases by their global federated area identifiers and/or human-readable federated area identifiers (e.g., the human-readable federated area identifiers **2568**), with the global federated area identifiers serving to resolve any conflict that may arise among the human-readable federated area identifiers).

[0801] At **3134**, the processor may add an indication to such a database of an inheritance relationship among the new federated area, the specified existing federated area, any base federated area to which the specified existing federated area is related, and any intervening federated area present between the specified existing federated area and the base federated area. As has been discussed, with such an inheritance relationship in place, any object stored within any base federated area to which the specified existing federated area may be related, within the specified existing federated, and/or within any intervening federated area that may be present between the specified existing federated area and such a base federated area may become accessible from within the new federated area as if stored within the new federated area.

[0802] At **3136**, the processor may add an indication to such a database of a priority relationship among the new federated area, the specified existing federated area, any base federated area to which the specified existing federated area is related, and any intervening federated area present between the specified existing federated area and the base federated area. As has been discussed, with such a priority relationship in place, the use of objects stored within the new federated area is given priority over the use of similar objects (e.g., other task routines **2440** that perform the same task) that may be stored within any base federated area to which the specified existing federated area may be related, within the specified existing federated, and/or within any intervening federated area that may be present between the specified existing federated area and such a base federated area.

[0803] At **3140**, the processor may check whether there is at least one other existing federated area that is connected to the requested new federated area within a set of related

federated areas such that it is to have at least an inheritance relationship with the requested new federated area such that it is to inherit objects from the requested new federated area. As has been discussed, this may occur where the requested new federated area is requested to be instantiated at a position within a linear hierarchy or within a branch of a hierarchical tree such that it is interposed between two existing federated areas.

[0804] If, at **3140**, there is such another federated area, then at **3142**, the processor may add an indication to such a database of an inheritance relationship among the other existing federated area, the requested new federated area, the specified existing federated area, any base federated area to which the specified existing federated area and the other federated area are related, and any intervening federated area present between the specified existing federated area and the base federated area. In this way, any object stored within any base federated area, within the specified existing federated, within any intervening federated area that may be present between the specified existing federated area and such a base federated area, or within the requested new federated area may become accessible from within the other existing federated area as if stored within the other existing federated area.

[0805] At **3144**, the processor may add an indication to such a database of a priority relationship among the other existing federated area, the requested new federated area, the specified existing federated area, any base federated area to which the specified existing federated area is related, and any intervening federated area present between the specified existing federated area and the base federated area. In this way, the use of objects stored within the other existing federated area is given priority over the use of similar objects (e.g., other task routines **2440** that perform the same task) that may be stored within the requested new federated area, any base federated area to which the specified existing federated area may be related, within the specified existing federated, and/or within any intervening federated area that may be present between the specified existing federated area and such a base federated area.

[0806] FIGS. **27A**, **27B**, **27C**, **27D**, **27E**, **27F** and **27G**, together, illustrate an example embodiment of a logic flow **3200**. The logic flow **3200** may be representative of some or all of the operations executed by one or more embodiments described herein. More specifically, the logic flow **3200** may illustrate operations performed by the processor(s) **2550** in executing the control routine **2540**, and/or performed by other component(s) of at least one of the federated devices **2500**.

[0807] At **3210**, a processor of a federated device of a distributed processing system (e.g., at least one processor **2550** of one of the federated devices **2500** of the distributed processing system **2000**) may receive a request from another device, via a network (e.g., one of the source devices **2100**, or one of the reviewing devices **2800**, via the network **2999**) and through a portal provided by the processor for access to other devices via the network, to store one or more objects (e.g., one or more of the objects **2220**, **2270**, **2330**, **2370**, **2440**, **2470**, **2720** and/or **2770**) within a specified federated area (e.g., one of the federated areas **2566**). As has been discussed, such a portal may employ any of a variety of protocols and/or handshake mechanisms to enable the receipt of requests for various forms of access to a federated area by other devices, as well as to exchange objects with

other devices, via the network. Alternatively, at **3310**, the processor may receive the one or more objects, via the network, and in a transfer associated with a synchronization relationship between a transfer area instantiated within the particular federated area and another transfer area instantiated within the other device, where the one or more objects are intended to be stored within the transfer area within the particular federated area.

[0808] At **3212**, in embodiments in which the federated device(s) that provide federated area(s) also control access thereto, the processor may perform a check of whether the request is from an authorized device and/or from an authorized person or entity (e.g., scholastic, governmental or business entity) operating the other device that is an authorized user of the specified federated area, and/or has been granted a level of access that includes the authorization to make such requests. As has been discussed, the processor may require the receipt of one or more security credentials from devices from which requests are received. If, at **3212**, the processor determines that the request is not from a device and/or user authorized to make such a request, then the processor may transmit an indication of denial of the request to the device via the network at **3214**.

[0809] However, if at **3212**, the processor determines that the request to store one or more objects within the specified federated area is authorized, then at **3220**, the processor may check whether the one or more objects includes one or more data sets (e.g., one or more of the flow input data sets **2330** and/or one or more mid-flow data sets **2370**). If so, then the processor may generate and assign a data object identifier for each data set that is to be stored (e.g., one or more of the data object identifiers **3331**) at **3222**. At **3224**, the processor may store each of the one or more data sets within the specified federated area. At **3226**, the processor may also store indications of aspects of the storage of each such data set (e.g., its size, whether stored as an undivided object or in a distributed manner, whether stored in distributable form (if applicable), the identity of the federated area in which it is stored and/or the identity of each device in which at least a portion of it is stored). As has been discussed, in some embodiments, such information may be stored as part of a separate data object location identifier (e.g., a data object location identifier **2332** or **2372**) for each such data set.

[0810] At **3230**, the processor may check whether the one or more objects includes one or more result reports (e.g., one or more of the result reports **2770**). If so, then the processor may generate and assign a result report identifier for each result report that is to be stored (e.g., one or more of the result report identifiers **2771**) at **3232**. At **3234**, the processor may store each of the one or more result reports within the specified federated area. At **3236**, the processor may also store indications of aspects of the storage of each such result report. As has also been discussed in reference to result reports, in some embodiments, such information may be stored as part of a separate result report location identifier (e.g., a result report location identifier **2772**) for each such result report.

[0811] At **3240**, the processor may check whether the one or more objects includes one or more task routines (e.g., one or more of the task routines **2440**). If so, then the processor may generate and assign a task routine identifier for each task routine that is to be stored (e.g., one or more of the task routine identifiers **2441**) at **3242**. At **3244**, the processor may store each of the one or more task routines within the

specified federated area. At **3246**, the processor may additionally check whether any of the task routines stored at **3244** have the same flow task identifier as another task routine that was already stored within the specified federated area (or within any base federated area to which the specified federated area is related and/or within any intervening federated area interposed therebetween), such that there is more than one task routine executable to perform the same task. If so, then at **3248** for each newly stored task routine that shares a flow task identifier with at least one other task routine already stored in the specified federated area (or within such a base or intervening federated area), the processor may store an indication of there being multiple task routines with the same flow task identifier, along with an indication of which is the most recent of the task routines for that flow task identifier.

[0812] As has been discussed, in embodiments in which task routines are stored in a manner organized into a database or other data structure (e.g., the task routine database **2564** within one or more related federated areas) by which flow task identifiers may be employed as a mechanism to locate task routines, the storage of an indication of there being more than one task routine sharing the same flow task identifier may entail associating more than one task routine with the same flow task identifier so that a subsequent search for task routines using that flow task identifier will beget a result indicating that there is more than one. As has also been discussed, the manner in which one of multiple task routines sharing the same flow task identifier may be indicated as being the most current version may entail ordering the manner in which those task routines are listed within the database (or other data structure) to cause the most current one to be listed at a particular position within that order (e.g., listed first).

[0813] At **3250**, the processor may check whether the one or more objects includes one or more macros (e.g., one or more of the macros **2470**). If so, then at **3252**, the processor may additionally check, for each macro, whether there is a corresponding task routine (or corresponding multiple versions of a task routine in embodiments in which a single macro may be based on multiple versions) stored within the specified federated area (or within any base federated area to which the specified federated area is related and/or within any intervening federated area interposed therebetween). If, at **3252**, there are any macros requested to be stored for which there is a corresponding task routine (or corresponding multiple versions of a task routine) stored in the specified federated area (or within such a base or intervening federated area), then for each such macro, the processor may assign the job flow identifier (e.g., one or more of the job flow identifiers **2221**) of the corresponding task routine (or may assign job flow identifiers of each of the versions of a task routine) at **3254**. At **3256**, the processor may store each of such macros.

[0814] At **3260**, the processor may check whether the one or more objects includes one or more job flow definitions (e.g., one or more of the job flow definitions **2220**). If so, then at **3262**, the processor may additionally check, for each job flow definition, whether that job flow definition defines a job flow that uses a neural network and was trained and/or tested using objects associated with another job flow (and/or performances thereof) that is defined to by its job flow definition to not use a neural network. As previously discussed, the preservation of such links between a neuromor-

phic job flow and an earlier non-neuromorphic job flow from which the neuromorphic job flow may be in some way derived may be of importance to ensuring accountability during a later evaluation of the neuromorphic job flow. For this reason, it may be deemed important to ensure that objects associated with the other non-neuromorphic job flow have already been stored in federated area(s) where they can be preserved for subsequent retrieval during such an evaluation of the neuromorphic job flow.

[0815] Presuming that there are no neuromorphic job flows requested to be stored that were derived from another non-neuromorphic job flow that is not already so stored, then at **3264**, the processor may additionally check, for each job flow definition, whether there is at least one task routine stored within the specified federated area (or within any base federated area to which the specified federated area is related and/or within any intervening federated area interposed therebetween) for each task specified by a flow task identifier within the job flow definition. If, at **3264**, there are any job flow definitions requested to be stored for which there is at least one task routine stored in the specified federated area (or within such a base or intervening federated area) for each task, then for each of those job flow definitions where there is at least one stored task routine for each task, the processor may generate and assign a job flow identifier (e.g., one or more of the job flow identifiers **2221**) at **3267**, and at **3269**, may then store each of the one or more job flow definitions for which there was at least one task routine for each task. Otherwise, at **3265**, for each job flow for which there is no task routine stored for one or more tasks, the processor may generate a DAG (e.g., one of the DAGs **2270**) that provides a visual indication of the lack of task routines for each such task, and may transmit the DAG to the other device.

[0816] At **3270**, the processor may check whether the one or more objects includes one or more instance logs (e.g., one or more of the instance logs **2720**). If so, then at **3272**, the processor may additionally check, for each instance log, whether each object identified in the instance log by its identifier is stored within the specified federated area (or within any base federated area to which the specified federated area is related and/or within any intervening federated area interposed therebetween). If, at **3272**, there are any instance logs requested to be stored for which each specified object is stored within the specified federated area (or within such a base or intervening federated area), then for each instance log where each object specified therein is so stored, the processor may generate and assign an instance log identifier (e.g., one or more of the instance log identifiers **2721**) at **3275**, and at **3277**, may then store each of the one or more instance logs for which each specified object is so stored. Otherwise, at **3273**, for each instance log for which there is an identified object that is not stored, the processor may generate a DAG that provides a visual indication of each such missing object, and may transmit the DAG to the other device.

[0817] At **3280**, the processor may check whether the one or more objects includes one or DAGs. If so, then at **3282**, the processor may additionally check, for each DAG, whether there is a corresponding task routine (or corresponding multiple versions of a task routine) for each task graph object (e.g., one of the task graph objects **2984**) and whether there is a corresponding data object for each data graph object (e.g., each data graph object **2983** or **2987**) stored within the specified federated area (or within any base

federated area to which the specified federated area is related and/or within any intervening federated area interposed therebetween). If, at **3282**, there are any of such DAGs to be stored in the specified federated area (or within such a base or intervening federated area) for which all of such task routines and data objects are so stored, then for each of such DAG, the processor may generate and assign a job flow identifier at **3285** in recognition of the possibility that such a DAG may be used as a new job flow definition, and at **3286**, may then store each of such DAGs. Otherwise, at **3265**, for each job flow for which there is no task routine stored for one or more tasks, the processor may generate a DAG (e.g., one of the DAGs **2270**) that provides a visual indication of the lack of task routines for each such task, and may transmit the DAG to the other device. Otherwise, at **3283**, for each DAG for which there is a task routine and/or a data object that is not stored, the processor may generate another DAG that provides a visual indication of each such missing object, and may transmit the other DAG to the other device.

[0818] FIGS. **28A**, **28B** and **28C**, together, illustrate an example embodiment of a logic flow **3300**. The logic flow **3300** may be representative of some or all of the operations executed by one or more embodiments described herein. More specifically, the logic flow **3300** may illustrate operations performed by the processor(s) **2550** in executing the control routine **2540**, and/or performed by other component (s) of at least one of the federated devices **2500**.

[0819] At **3310**, a processor of a federated device of a distributed processing system (e.g., at least one processor **2550** of one of the federated devices **2500** of the distributed processing system **2000**) may receive a request from a device, via a network (e.g., one of the source devices **2100**, or one of the reviewing devices **2800**, via the network **2999**) and through a portal provided by the processor for access to other devices via the network, to store a task routine (e.g., one of the task routines **2440**) within a particular federated area specified in the request (e.g., one of the federated areas **2566**). Again, such a portal may be generated by the processor to employ any of a variety of protocols and/or handshake mechanisms to enable the receipt of requests for various forms of access to the federated area by other devices, as well as to exchange objects with other devices, via the network. Alternatively, at **3310**, the processor may receive the task routine, via the network, and in a transfer associated with a synchronization relationship between a transfer area instantiated within the particular federated area and another transfer area instantiated within the other device, where the task routine is intended to be stored within the transfer area within the particular federated area.

[0820] At **3312**, in embodiments in which the federated device(s) that provide federated area(s) also control access thereto, the processor may perform a check of whether the request or synchronization relationship transfer is from an authorized device and/or from an authorized person or entity (e.g., scholastic, governmental or business entity) operating the device that is an authorized user of the specified federated area. As has been discussed, the processor may require the receipt of one or more security credentials from devices from which requests are received and/or with which transfers of objects associated with synchronization relationships are performed. If, at **3312**, the processor determines that there is no such authorization, then the processor may

transmit an indication of denial of the storage of the task routine to the other device via the network at **3314**.

[**0821**] However, if at **3312**, the processor determines that there is such authorization, then at **3320**, the processor may check whether the task routine has the same flow task identifier as any of the task routines already stored within the particular federated area (or within any base federated area to which the specified federated area is related and/or within any intervening federated area interposed therebetween), such that there is already stored one or more other task routines executable to perform the same task. If not at **3320**, then the processor may generate and assign a task routine identifier for the task routine (e.g., one of the task routine identifiers **2441**) at **3322**. At **3324**, the processor may store the task routine within the particular federated area in a manner that enables later retrieval of the task routine by either its identifier or by the flow task identifier of the task that it performs.

[**0822**] However, if at **3320**, there is at least one other task routine with the same flow task identifier already stored within the particular federated area (or within such a base or intervening federated area), then at **3330**, the processor may translate the portions of executable instructions within each of these task routines that implement the input and/or output interfaces to generate intermediate representation(s) of the input and/or output interfaces for each of these task routines. As has been discussed, it may be that different ones of these task routines are written in different programming languages, which may make direct comparisons of implementations of input and/or output interfaces relatively difficult, and it may be that the intermediate representations generated for each include executable instructions generated in an intermediate programming language to better facilitate such direct comparisons. Alternatively or additionally, the intermediate representations may include a data structure of various values for various parameters of input and/or output interfaces that better enable such direct comparisons. At **3332**, the processor may perform such comparisons using the intermediate representations.

[**0823**] Based on the results of those comparisons, the processor may check at **3340**: 1) whether the input interfaces (e.g., data interfaces **2443** that receive data from data objects, and/or task interfaces **2444** that receive parameters from another task routine) are implemented in the task routine in a manner that is identical to those of the one or more other task routines with the same flow task identifier that are already so stored, and 2) whether the output interfaces (e.g., data interfaces **2443** that output a data object, and/or task interfaces **2444** that output parameters to another task routine) are implemented in the task routine in a manner that is either identical to or a superset of those of the one or more task routines with the same flow task identifier that are already stored within the federated area (or within such a base or intervening federated area). If at **3340**, the input interfaces are identical, and each of the output interfaces of the task routine is identical to or a superset of the corresponding output interface within the one or more other task routine(s) already stored within the federated area (or within such a base or intervening federated area), then the processor may generate and assign a task routine identifier for the task routine at **3350**. At **3352**, the processor may store the task routine within the specified federated area in a manner that enables later retrieval of the task routine by either its identifier or by the flow task identifier of the task that it

performs. At **3354**, the processor may also store an indication of there being multiple task routines with the same flow task identifier, along with an indication of which is the most recent of the task routines for that flow task identifier.

[**0824**] However, if at **3340**, the input interface(s) are not identical, or the output interface(s) of the task routine are neither identical nor a superset, then at **3342**, the processor may generate a DAG (e.g., one of the DAGs **2270**) that provides a visual indication of the mismatch, and may transmit the DAG to the other device. If, at **3344**, the task routine was received in a transfer from the other device as a result of a synchronization relationship, then the processor may proceed with the assignment of a task routine identifier at **3350**, followed by storage of the task routine, etc. As has been discussed, proceeding with the storage of the task routine in spite of such a mismatch in implementations of input and/or output interfaces may be deemed desirable as it results in the synchronization relationship between the two transfer areas being maintained such that the contents of the two transfer areas are caused to be synchronized with each other. It may be deemed sufficient that the DAG providing a visualization of the details of the mismatch is generated and provided to the other device as a mechanism to notify the developer(s) who created the task routine so that they are able to correct it.

[**0825**] FIGS. **29A**, **29B** and **29C**, together, illustrate an example embodiment of a logic flow **3400**. The logic flow **3400** may be representative of some or all of the operations executed by one or more embodiments described herein. More specifically, the logic flow **3400** may illustrate operations performed by the processor(s) **2550** in executing the control routine **2540**, and/or performed by other component(s) of at least one of the federated devices **2500**.

[**0826**] At **3410**, a processor of a federated device of a distributed processing system (e.g., at least one processor **2550** of one of the federated devices **2500** of the distributed processing system **2000**) may receive a request from another device, via a network (e.g., one of the source devices **2100**, or one of the reviewing devices **2800**, via the network **2999**) and through a portal provided by the processor for access to other devices via the network, to store a job flow definition (e.g., one of the job flow definitions **2220**) within a particular federated area specified within the request (e.g., one of the federated areas **2566**). Alternatively, at **3410**, the processor may receive the job flow definition, via the network, and in a transfer associated with a synchronization relationship between a transfer area instantiated within the particular federated area and another transfer area instantiated within the other device, where the job flow definition is intended to be stored within the transfer area within the particular federated area.

[**0827**] At **3412**, in embodiments in which the federated device(s) that provide federated area(s) also control access thereto, the processor may perform a check of whether the request is from an authorized device and/or from an authorized person or entity (e.g., scholastic, governmental or business entity) operating the device that is an authorized user of the specified federated area, and/or has been granted a level of access that includes the authorization to make such requests. As has been discussed, the processor may require the receipt of one or more security credentials from devices from which requests are received. If, at **3412**, the processor determines that the request is not from a device and/or user authorized to make such a request, then the processor may

transmit an indication of denial of the storage of the job flow definition to the device via the network at **3414**.

[0828] However, if at **3412**, the processor determines that the request to store a job flow definition within the specified federated area is authorized, then at **3420**, the processor may check whether the job flow of the job flow definition uses a neural network that was trained based on another job flow that does not use a neural network. If, at **3420**, the processor determines that the job flow of the job flow definition does not use a neural network, or if at **3422**, the processor determines that the other job flow definition is stored in the particular federated area (or within any base federated area to which the particular federated area is related and/or within any intervening federated area interposed therebetween), then at **3430**, the processor may check whether there is at least one task routine stored within the federated area (or within any such base or such intervening federated area) for each task specified by a flow task identifier within the job flow definition.

[0829] However, if at **3420**, the processor determines that the job flow of the job flow definition does use a neural network, and if at **3422**, the other job flow definition is not so stored, then at **3424**, the processor may check whether the job flow definition was received in a transfer from the other device as a result of a synchronization relationship. If not then, the processor may transmit an indication of denial of the storage of the job flow definition to the other device via the network at **3414**. Otherwise, the processor may transmit an indication of an error arising from the other job flow definition not being so stored at **3426**, before proceeding to the check made at **3430**.

[0830] If, at **3430**, there is at one task routine stored in the particular federated area (or within any base federated area to which the particular federated area is related and/or within any intervening federated area interposed therebetween) for each of the tasks specified by the job flow, then the processor may proceed to another check made at **3440**. However, if at **3430**, there are no task routines stored within the federated area (or within such a base or intervening federated area) for one or more of the tasks specified by the job flow, then at **3432**, the processor may generate a DAG that provides a visual depiction of the lack of task routines for one or more tasks, and may transmit it to the other device. Then, if at **3434**, the job flow definition was received in a transfer from the other device as a result of a synchronization relationship, the processor may proceed to the check made at **3440**.

[0831] At **3440**, the processor may check: 1) whether the input interfaces (e.g., data interfaces **2443** that receive data from data objects, and/or task interfaces **2444** that receive parameters from another task routine) that are implemented in the task routines stored in the federated area (or within such a base or intervening federated area) are identical to those specified in the job flow definition at **3440**, and 2) whether the output interfaces (e.g., data interfaces **2443** that output a data object, and/or task interfaces **2444** that output parameters to another task routine) that are implemented in the task routines that are already stored within the federated area (or within such a base or intervening federated area) are identical to or are supersets of those specified in the job flow definition.

[0832] If at **3440**, the input interfaces are identical, and if all of the output interfaces of all of the task routines already so stored are either identical to and/or are supersets of corresponding output interfaces specified in the job flow

definitions, then the processor may generate and assign a job flow identifier for the job flow definition at **3446**, and at **3448**, may store the job flow definition within the particular federated area in a manner that enables later retrieval of the job flow by its identifier.

[0833] However, if at **3340**, the input interfaces are not identical, or if an output interface of one or more of the task routines already so stored is neither identical nor a superset of a corresponding output interface specified in the job flow definition, then at **3442**, the processor may generate a DAG that provides a visual indication of the mismatch, and may transmit it to the other device via the network. If, at **3444**, the job flow definition was received in a transfer from the other device as a result of a synchronization relationship, the processor may proceed to the generation and transmission of a DAG at **3446**.

[0834] FIGS. **30A**, **30B**, **30C** and **30D**, together, illustrate an example embodiment of a logic flow **3500**. The logic flow **3500** may be representative of some or all of the operations executed by one or more embodiments described herein. More specifically, the logic flow **3500** may illustrate operations performed by the processor(s) **2550** in executing the control routine **2540**, and/or performed by other component(s) of at least one of the federated devices **2500**.

[0835] At **3510**, a processor of a federated device of a distributed processing system (e.g., at least one processor **2550** of one of the federated devices **2500** of the distributed processing system **2000**) may receive a request from a device, via a network (e.g., one of the source devices **2100**, or one of the reviewing devices **2800**, via the network **2999**) and through a portal provided by the processor, to delete one or more objects (e.g., one or more of the objects **2220**, **2330**, **2370**, **2440**, **2720** and/or **2770**) within a particular federated area specified in the request (e.g., one of the federated areas **2566**).

[0836] At **3512**, in embodiments in which the federated device(s) that provide federated area(s) also control access thereto, the processor may perform a check of whether the request is from an authorized device and/or from an authorized person or entity (e.g., scholastic, governmental or business entity) operating the device that is an authorized user of the specified federated area, as well as any federated area that may branch from the specified federated area, and/or has been granted a level of access that includes the authorization to make such requests. As has been discussed, the processor may require the receipt of one or more security credentials from devices from which requests are received. If, at **3512**, the processor determines that the request is not from a device and/or user authorized to make such a request, then the processor may transmit an indication of denial of the request to the device via the network at **3514**.

[0837] However, if at **3512**, the processor determines that the request to delete one or more objects within the specified federated area is authorized, then at **3520**, the processor may check whether the one or more objects includes one or more data sets (e.g., one or more of the data sets **2330** or **2370**). If so, then the processor may delete the one or more data sets from the specified federated area at **3522**. At **3524**, the processor may additionally check whether there are any result reports or instance logs stored in the specified federated area (or within any federated area that branches from the specified federated area) that were generated in a past performance of a job flow in which any of the one or more deleted data sets were used. If so, then at **3526**, the processor

may delete such result report(s) and/or instance log(s) from the specified federated area and/or from one or more other federated areas that branch from the specified federated area.

[0838] As previously discussed, it may be deemed desirable for reasons of maintaining repeatability to avoid a situation in which there is an instance log that specifies one or more objects, such as data sets, as being associated with a performance of a job flow where the one or more objects are not present within any accessible federated area such that the performance of the job flow cannot be repeated. It is for this reason that the deletion of a data set from the specified federated area is only to be performed if a check can be made within federated areas that branch from the specified federated area for such objects as instance logs and/or result reports that have such a dependency on the data set to be deleted. And, it is for this reason that a request for such a deletion may not be deemed to be authorized unless received from a device and/or user that has authorization to access all of the federated areas that branch from the specified federated area.

[0839] At **3530**, the processor may check whether the one or more objects includes one or more result reports (e.g., one or more of the result reports **2770**). If so, then the processor may delete the one or more result reports from the specified federated area at **3532**. At **3534**, the processor may additionally check whether there are any instance logs stored in the specified federated area (or within any federated area that branches from the specified federated area) that were generated in a past performance of a job flow in which any of the one or more deleted result reports were generated. If so, then at **3536**, the processor may delete such instance log(s) from the federated area and/or from the one or more other federated areas that branch from the specified federated area.

[0840] At **3540**, the processor may check whether the one or more objects includes one or more task routines (e.g., one or more of the task routines **2440**). If so, then the processor may delete the one or more task routines from the specified federated area at **3542**. At **3544**, the processor may additionally check whether there are any other task routines stored in the specified federated area (or within a federated area that branches from the specified federated area) that share the same flow task identifier(s) as any of the deleted task routines. If so, then at **3546**, the processor may delete such task routine(s) from the specified federated area and/or from the one or more other federated areas that branch from the specified federated area. At **3550**, the processor may additionally check whether there are any result reports or instance logs stored in the specified federated area (or within a federated area that branches from the specified federated area) that were generated in a past performance of a job flow in which any of the one or more deleted task routines were used. If so, then at **3552**, the processor may delete such result report(s) and/or instance log(s) from the specified federated area and/or from the one or more other federated areas that branch from the specified federated area.

[0841] At **3560**, the processor may check whether the one or more objects includes one or more job flow definitions (e.g., one or more of the job flow definitions **2220**). If so, then at **3562**, the processor may delete the one or more job flow definitions within the specified federated area. At **3564**, the processor may additionally check whether there are any result reports or instance logs stored in the specified federated area (or within a federated area that branches from the specified federated area) that were generated in a past

performance of a job flow defined by any of the one or more deleted job flow definitions. If so, then at **3566**, the processor may delete such result report(s) and/or instance log(s) from the federated area and/or from the one or more other federated areas that branch from the specified federated area.

[0842] At **3570**, the processor may check whether the one or more objects includes one or more instance logs (e.g., one or more of the instance logs **2720**). If so, then at **3572**, the processor may delete the one or more instance logs from the specified federated area.

[0843] FIGS. **31A** and **31B**, together, illustrate an example embodiment of a logic flow **3600**. The logic flow **3600** may be representative of some or all of the operations executed by one or more embodiments described herein. More specifically, the logic flow **3600** may illustrate operations performed by the processor(s) **2550** in executing the control routine **2540**, and/or performed by other component(s) of at least one of the federated devices **2500**.

[0844] At **3610**, a processor of a federated device of a distributed processing system (e.g., at least one processor **2550** of one of the federated devices **2500** of the distributed processing system **2000**) may receive a request from a device, via a network (e.g., one of the reviewing devices **2800** via the network **2999**) and through a portal provided by the processor, to repeat a previous performance of a job flow that generated either a result report or an instance log (e.g., one of the result reports **2770** or one of the instance logs **2720**) specified in the request (e.g., with a result report identifier **2771** or an instance log identifier **2721**), or to provide the requesting device with the objects (e.g., one or more of the objects **2220**, **2330**, **2370**, **2440**, **2720** and/or **2770**) needed to enable the requesting device to do so. As previously discussed, persons and/or entities involved in peer reviewing and/or other forms of review of analyses may operate a device to make a request for one or more federated devices to repeat a performance of a job flow to verify an earlier performance, or may make a request for the objects needed to allow the persons and/or entities to independently repeat the performance.

[0845] At **3612**, in embodiments in which the federated device(s) that provide federated area(s) also control access thereto, the processor may perform a check of whether the request is from an authorized device and/or from an authorized person or entity (e.g., scholastic, governmental or business entity) operating the device that is an authorized user of at least one federated area, and/or has been granted a level of access that includes the authorization to make such requests. As has been discussed, the processor may require the receipt of one or more security credentials from devices from which requests are received. If, at **3612**, the processor determines that the request is not from a device and/or user authorized to make such a request, then the processor may transmit an indication of denial of the request to the requesting device via the network at **3614**.

[0846] However, if at **3612**, the processor determines that the request is authorized, then at **3620**, if the a result report was specified for the previous performance in the request, instead of the instance log, then at **3622**, the processor may use the result report identifier provided in the request for the result report to retrieve the instance log for the previous performance. Alternatively, if the instance log was specified for the previous performance in the request, then at **3624**, the

processor may use the instance log identifier provided in the request to retrieve the instance log for the previous performance.

[0847] At 3630, regardless of the exact manner in which the instance log is retrieved, the processor may use the identifiers specified in the instance log for the objects associated with the previous performance to retrieve each of those objects. It should be noted that, as has been previously discussed, searches for objects to fulfill such a request received from a particular requesting device may be limited to the one or more federated areas to which that particular requesting device and/or a user operating the requesting device has been granted access (e.g., a particular private or intervening federated area, as well as any base federated area and/or any other intervening federated area interposed therebetween). Therefore, the retrieval of objects used in the previous performance, and therefore, needed again to independently regenerate the result report, may necessarily be limited to such authorized federated area(s).

[0848] At 3632, the processor may check whether the job flow relies on the use of a neural network that was trained using one or more performances of another job flow that does not rely on the use of a neural network. If so, then at 3634, the processor may use an identifier in either of the job flow definition or instance log retrieved for the previous performance that provides a link to the job flow definition or instance log of the other job flow to retrieve objects associated with the other job flow and/or one or more performances of the other job flow.

[0849] Regardless of whether the job flow of the previous performance referred to in the request relies on the use of a neural network, if, at 3640, the request was to provide the objects needed to enable an independent repeat of the previous performance of the job flow referred to in the request, then at 3642, the processor may transmit the retrieved objects associated with that previous performance to the requesting device to so enable such an independent repeat performance. As previously discussed, the regenerated result report may be compared at the requesting device to the result report that was previously generated during the previous performance to verify one or more aspects of the previous performance. However, if at 3640, the request received was not to so provide the retrieved objects, but instead, was for one or more federated devices to repeat the previous performance of the job flow, then at 3650, the processor may employ the objects retrieved at 3630 to repeat the previous performance, and thereby regenerate the result report. As previously discussed, in some embodiments, including embodiments in which one or more of the data sets associated with the previous performance is relatively large in size, the processor of the federated device may cooperate with the processors of multiple other federated devices (e.g., operate as the federated device grid 1005) to portions of the repeat performance among multiple federated devices to be carried out at least partially in parallel. At 3652, the processor may compare the regenerated result report to the result report previously generated in the previous performance of the job flow. The processor may then transmit the results of that comparison to the requesting device at 3654.

[0850] However, if, at 3632, the job flow of the previous performance referred to in the request does rely on the use of a neural network, then, in addition to retrieving objects associated with the other job flow at 3634, the processor may check at 3660 whether the request was to provide the objects

needed to enable an independent repeat of the previous performance. If so, then at 3662, the processor may transmit the retrieved objects associated with that other job flow to the requesting device to enable aspects of the other job flow and/or one or more performances thereof to also be evaluated. However, if at 3660, the request received was not to so provide the retrieved objects, but instead, was for one or more federated devices to repeat the previous performance of the job flow, then at 3670, the processor may employ the objects retrieved at 3634 to perform the other job flow, and do so with the data set(s) associated with the previous performance of the job flow referred to in the request. At 3672, the processor may compare the result report(s) generated by the performance of the other job flow to the corresponding result reports regenerated from the repetition at 3650 of the previous performance of the job flow referred to in the request. The processor may then transmit the results of that comparison to the requesting device at 3674.

[0851] FIGS. 32A and 32B, together, illustrate an example embodiment of a logic flow 3700. The logic flow 3700 may be representative of some or all of the operations executed by one or more embodiments described herein. More specifically, the logic flow 3700 may illustrate operations performed by the processor(s) 2550 in executing the control routine 2540, and/or performed by other component(s) of at least one of the federated devices 2500.

[0852] At 3710, a processor of a federated device of a distributed processing system (e.g., at least one processor 2550 of one of the federated devices 2500 of the distributed processing system 2000) may receive a request from a requesting device, via a network (e.g., one of the reviewing devices 2800 via the network 2999) and through a portal provided by the processor, to repeat a previous performance a job flow with one or more data sets (e.g. one or more of the flow input data sets 2330) specified in the request by a job flow identifier and one or more data object identifiers (e.g., one of the job flow identifiers 2221, and one or more of the data object identifiers 2331). As previously discussed, persons and/or entities involved either in consuming results of analyses or in reviewing past performances of analyses may operate a device to make a request for one or more federated devices to repeat a performance of a job flow.

[0853] At 3712, in embodiments in which the federated device(s) that provide federated area(s) also control access thereto, the processor may perform a check of whether the request is from an authorized device and/or from an authorized person or entity (e.g., scholastic, governmental or business entity) operating the device that is an authorized user of at least one federated area, and/or has been granted a level of access that includes the authorization to make such requests. As has been discussed, the processor may require the receipt of one or more security credentials from devices from which requests are received. If, at 3712, the processor determines that the request is not from a device and/or user authorized to make such a request, then the processor may transmit an indication of denial of the request to the device via the network at 3714.

[0854] However, if at 3712, the processor determines that the request for a repeat of a performance of the specified job flow with the specified one or more data sets is authorized, then at 3720, the processor may use the combination of the job flow identifier and the one or more data object identifiers to search within one or more federated areas to which the requesting device and/or a user of the requesting

device has been granted access for an instance log associated with a previous performance of the job flow with the one or more data sets.

[0855] It should be noted that, as has been previously discussed, searches for objects to fulfill such a request received from a requesting device may be limited to the one or more federated areas to which that requesting device and/or a user operating the requesting device has been granted access (e.g., a particular private or intervening federated area, as well as any base federated area and/or any other intervening federated area interposed therebetween). Therefore, the retrieval of objects needed to repeat a previous performance of a job flow may necessarily be limited to such authorized federated area(s).

[0856] If, at **3730**, the processor determines, as a result of the search at **3720**, that there is no such instance log, then at **3732**, the processor may retrieve the job flow definition specified by the job flow identifier provided in the request (e.g., one of the job flow definitions **2220**) from the one or more federated areas for which authorization to access has been granted to the requesting device and/or the user of the requesting device. At **3734**, the processor may then retrieve the most recent version of task routine for each task specified in the job flow definition by a flow task identifier (e.g., one or more of the task routines **2440**, each specified by a flow task identifiers **2241**) from the one or more federated areas to which access has been granted. At **3736**, the processor may retrieve each of the one or more data sets specified by the one or more data object identifiers from the one or more federated areas to which access has been granted, and may then use the retrieved job flow definition, the retrieved newest versions of task routines, and the retrieved one or more data sets to perform the job flow as requested. At **3738**, the processor may transmit the results of the performance to the requesting device. As an alternative to (or in addition to) performing the job flow with the most recent versions of the task routines, the processor may transmit an indication to the requesting device that no record has been found of a previous performance in the one or more federated areas to which access has been granted.

[0857] However, if at **3730**, the processor successfully locates (during the search at **3720**) such an instance log, then the processor may additionally determine at **3740** whether there is more than one such instance log, each of which is associated with a different performance of the job flow with the one or more data sets specified in the request. If, at **3740**, only one such instance log was located during the search at **3720**, then at **3750**, the processor may then retrieve the versions specified in the instance log of each of the task routines specified in the job flow definition for each task by a flow task identifier from the one or more federated areas to which access has been granted. At **3752**, the processor may retrieve each of the one or more data sets specified by the one or more data object identifiers from the one or more federated areas to which access has been granted, and may then use the retrieved job flow definition, the retrieved specified versions of task routines, and the retrieved one or more data sets to perform the job flow as requested. At **3754**, the processor may additionally retrieve the result report generated in the previous performance of the job flow from the one or more federated areas to which access has been granted, and may compare the retrieved result report to the new result report generated in the new performance of the job flow at **3756**. At **3758**, the processor may transmit the

results of the comparison of result reports to the requesting device, and may transmit the new result report, itself, to the requesting device at **3758**.

[0858] However, if at **3740**, there is more than one such instance log located found during the search at **3720**, then the processor may transmit an indication of the available selection of the multiple previous performances that correspond to the multiple located instance logs to the requesting device at **3742** with a request that one of the multiple previous performances be selected as the one from which the instance log will be used. The processor may then await receipt of an indication of a selection of one of the multiple previous performances at **3744** before proceeding to retrieve specific versions of task routines at **3750**.

[0859] FIGS. **33A**, **33B**, **33C** and **33D**, together, illustrate an example embodiment of a logic flow **3800**. The logic flow **3800** may be representative of some or all of the operations executed by one or more embodiments described herein. More specifically, the logic flow **3800** may illustrate operations performed by the processor(s) **2550** in executing the control routine **2540**, and/or performed by other component (s) of at least one of the federated devices **2500**.

[0860] At **3810**, a processor of a federated device of a distributed processing system (e.g., at least one processor **2550** of one of the federated devices **2500** of the distributed processing system **2000**) may receive a request from a device, via a network (e.g., one of the reviewing devices **2800** via the network **2999**) and through a portal provided by the processor, to perform a job flow with one or more data sets (e.g. one or more of the flow input data sets **2330**) specified in the request by a job flow identifier and one or more data object identifiers (e.g., one of the job flow identifiers **2221**, and one or more of the data object identifiers **2331**).

[0861] At **3812**, in embodiments in which the federated device(s) that provide federated area(s) also control access thereto, the processor may perform a check of whether the request is from an authorized device and/or from an authorized person or entity (e.g., scholastic, governmental or business entity) operating the device that is an authorized user of at least one federated area, and/or has been granted a level of access that includes the authorization to make such requests. As has been discussed, the processor may require the receipt of one or more security credentials from devices from which requests are received. If, at **3812**, the processor determines that the request is not from a device and/or user authorized to make such a request, then the processor may transmit an indication of denial of the request to the device via the network at **3814**.

[0862] However, if at **3812**, the processor determines that the request for a performance of the specified job flow with the specified one or more data sets is authorized, then at **3820**, the processor may use the job flow identifier provided in the request to retrieve the corresponding job flow definition (e.g., one of the job flow definitions **2220**) from within one or more federated areas to which the requesting device and/or a user of the requesting device has been granted access. At **3822**, the processor may then retrieve the most recent version of task routine for each task specified in the job flow definition by a flow task identifier (e.g., one or more of the task routines **1440**, each specified by a flow task identifiers **1241**) that is stored within the one

or more federated areas to which the requesting device and/or a user of the requesting device has been granted access.

[0863] It should be noted that, as has been previously discussed, searches for objects to fulfill such a request received from a particular device may be limited to the one or more federated areas to which that requesting device and/or a user operating the requesting device has been granted access (e.g., a particular private or intervening federated area, as well as any base federated area and/or any other intervening federated area interposed therebetween). Therefore, the retrieval of objects needed to perform a specified job flow may necessarily be limited to such authorized federated area(s).

[0864] At 3824, the processor may use the combination of the job flow identifier and the one or more data object identifiers to search for an instance log associated with a previous performance of the job flow with the one or more data sets within the one or more federated areas to which the requesting device and/or a user of the requesting device has been granted access. If, at 3830, the processor determines (during the search at 3824) that there is no such instance log, then at 3832, the processor may then check whether all of the retrieved newest versions of task routines are written in the same programming language. As has been discussed, there may be an expectation that, normally, task routines are all written in a single primary programming language that is normally supported for executing the executable instructions within task routines (e.g., the executable instructions 2447). However, as has also been discussed, it may be that there is a mixture of two or more programming languages (e.g., the primary programming language along with one or more secondary programming languages) among a set of task routines to be executed in performing the tasks of a job flow.

[0865] If, at 3832, all of the retrieved most recent versions of task routines are written in the same programming language (e.g., the primary programming language), then at 3834, the processor may retrieve each of the one or more data sets specified by the one or more data object identifiers from the one or more federated areas to which the requesting device and/or a user of the requesting device has been granted access, and may then use the retrieved job flow definition, the retrieved newest versions of task routines, and the retrieved one or more data sets to perform the job flow as requested. In so doing, the processor may be caused to use the same runtime interpreter or compiler to execute the executable instructions within all of the retrieved most recent versions of task routines. At 3838, the processor may then transmit the results of the performance to the requesting device. However, if at 3832, there is a mixture of programming languages is used among the retrieved most recent versions of task routines, then at 3836, the processor may retrieve each of the one or more data sets specified by the one or more data object identifiers from the one or more federated areas to which the requesting device and/or a user of the requesting device has been granted access, and may then use the retrieved job flow definition, the retrieved newest versions of task routines, and the retrieved one or more data sets to perform the job flow, but may do so using a combination of multiple different runtime interpreters and/or compilers to execute the executable instructions within each of those task routines. At 3838, the processor may then transmit the results of the performance to the requesting device.

[0866] However, if at 3830, the processor successfully locates such an instance log (during the search at 3824), then the processor may additionally determine at 3840 whether there is more than one such instance log, each of which is associated with a different performance of the job flow with the one or more data sets specified in the request. If only one such instance log is located at 3840, then at 3850, the processor may then retrieve the versions specified in the instance log of each of the task routines for each task specified in the job flow definition by a flow task identifier from the one or more federated areas to which the requesting device and/or a user of the requesting device has been granted access. However, if at 3840, there is more than one such instance log located, then the processor may analyze the multiple instance logs to identify and select the instance log from among the multiple instance logs that is associated with the most recent performance of the job flow at 3842, before proceeding to retrieve specified versions task routines for each task of the job flow at 3850.

[0867] At 3852, for each task specified in the job flow definition, the processor may compare the retrieved version of the task routine identified in the instance log to the newest version stored within the one or more federated areas to which the requesting device and/or a user of the requesting device has been granted access to determine whether each of the retrieved task routines is the newest version. At 3860, if each of the retrieved task routines is the newest version thereof, then there is no need to perform the job flow anew, as the most recent previous performance (or the only previous performance) already used the newest version of each task routine such that the result report generated is already the most up to date form of the result report, possible. Thus, at 3862, the processor may retrieve the result report of that previous performance using the result report identifier specified by the instance log from the one or more federated areas to which the requesting device and/or a user of the requesting device has been granted access, and may then transmit the result report to the requesting device at 3734.

[0868] However, if at 3860, one or more of the task routines specified in the instance log and retrieved from the one or more federated areas to which the requesting device and/or a user of the requesting device has been granted access is not the newest version thereof, then at 3870, the processor may parse the job flow set forth in the job flow definition to identify the earliest task within the job flow at which the version of the task routine so retrieved is not the newest version. At 3872, the processor may then check whether all of the newest versions of task routines, starting with the task routine for the identified earliest task, proceeding through the task routines for each of the later tasks in the job flow, are written in the same programming language.

[0869] If, at 3872, all such retrieved newest task routines are written in the same programming language, then at 3874, starting at the identified earliest task, the processor may use the newest version of task routine for that task and for each later task in the job flow to perform that task and each of the later tasks, thereby taking advantage of the one or more earlier tasks of job flow at which the newest version of task routine was used in the most recent previous performance (or the only previous performance). In so doing, the processor may be caused to use the same runtime interpreter or compiler to execute the executable instructions within all of such retrieved most recent versions of task routines. The processor may then transmit the result report generated in

such a partial performance of the job flow to the requesting device at **3878**. However, if at **3872**, there is a mixture of programming languages is used among these particular most recent versions of task routines, then at **3876**, the processor may use the newest version of task routine for that earliest identified task and for each later task in the job flow to perform that task and each of the later tasks, but may do so using a combination of multiple different runtime interpreters and/or compilers to execute the executable instructions within each of those task routines. The processor may then transmit the result report generated in such a partial performance of the job flow to the requesting device at **3878**.

[**0870**] FIGS. **34A** and **34B**, together, illustrate an example embodiment of a logic flow **4100**. The logic flow **4100** may be representative of some or all of the operations executed by one or more embodiments described herein. More specifically, the logic flow **4100** may illustrate operations performed by the processor(s) **2550** in executing the control routine **2540**, and/or performed by other component(s) of at least one of the federated devices **2500**.

[**0871**] At **4110**, a processor of a federated device of a distributed processing system (e.g., at least one processor **2550** of one of the federated devices **2500** of the distributed processing system **2000**) may receive a request from another device, via a network (e.g., one of the source devices **2100**, or one of the reviewing devices **2800**, via the network **2999**) and through a portal provided by the processor for access to other devices via the network, to store a data object (e.g., one of the flow input data objects **2330**, one of the mid-flow data objects **2370** or one of the result reports **277**) within a particular federated area specified within the request (e.g., one of the federated areas **2566**). Alternatively, at **4110**, the processor may receive the data object, via the network, and in a transfer associated with a synchronization relationship between a transfer area instantiated within the particular federated area and another transfer area instantiated within the other device, where the job flow definition is intended to be stored within the transfer area within the particular federated area.

[**0872**] At **4112**, in embodiments in which the federated device(s) that provide federated area(s) also control access thereto, the processor may perform a check of whether the request is from an authorized device and/or from an authorized person or entity (e.g., scholastic, governmental or business entity) operating the device that is an authorized user of the specified federated area, and/or has been granted a level of access that includes the authorization to make such requests. As has been discussed, the processor may require the receipt of one or more security credentials from devices from which requests are received. If, at **4112**, the processor determines that the request is not from a device and/or user authorized to make such a request, then the processor may transmit an indication of denial of the storage of the job flow definition to the device via the network at **4114**.

[**0873**] However, if at **4112**, the processor determines that the request to store a job flow definition within the specified federated area is authorized, then the processor may generate and assign a data object identifier for the data object at **4116**.

[**0874**] If, at **4120**, the size of the data object is not larger than a predetermined threshold size, then at **4122**, the processor may provide the data object to at least one storage device of a set of storage devices (e.g., one of the storage devices **2600a-x** and/or **2600z**), or to at least one federated device of a set of federated devices being used to store

objects (e.g., one of the federated devices **2500a-x** and/or **2500z**) to be stored within the federated area specified in the request as an undivided object within the storage space provided by a single one of the set of storage devices, or federated devices, for the specified federated area. As previously discussed, in some embodiments, the predetermined threshold size may be determined to be set to be equal to (or in some other way based on) the threshold size used by the set of storage devices to determine whether to divide a data object into multiple data object blocks. At **4124**, the processor may also store indications of aspects of the storage of the data object (e.g., its size, whether stored as an undivided object or in a distributed manner, whether stored in distributable form (if applicable), the identity of the federated area in which it is stored and/or the identity of each device in which at least a portion of it is stored).

[**0875**] However, if at **4120**, the size of the data object is larger than the predetermined threshold size, then at **4130**, the processor may check whether the data object is already in a distributable form. As previously discussed, a distributable form of a data object may entail having no distinct metadata data structure (e.g., the metadata **2338**), and having the data items thereof organized into a single homogeneous data structure (e.g., the data items **2339** organized into a single homogeneous data structure **2335d**). Further, in some of such embodiments, there may be a limited preselected set of types of homogeneous data structure from which the type of the single homogeneous data structure is to be selected.

[**0876**] If, at **4130**, the data object is already in such a distributable form, then the processor may provide the data object to the set of storage devices, or the set of federated devices being employed as a set of storage devices, to be divided up by that set of devices into multiple data object blocks (e.g., the data object blocks **2336d**) that are then stored in a distributed manner as by being distributed among that set of devices such that each data object block is stored within a portion of one of the devices that provides a portion of a distributed file system that spans that set of devices and in which the specified federated area has been defined to also span that set of devices. Following such distributed storage, the processor may then store indications of aspects of the storage of the data object at **4124**.

[**0877**] However, if at **4130**, the data object is not already in such a distributable form, then the processor may convert the data object from the form in which it was originally received and into a distributable form at **4140**. At **4142**, the processor may store indications of one or more characteristics of the original form (e.g., the metadata **2338**) for future use in re-creating the original form, before discarding the original form at **4144**, and then providing the distributable form to the set of storage devices, or of federated devices used as storage devices, at **4132**. Alternatively, and as previously discussed, the processor may provide both the original and distributable forms of the data object to the set of storage devices to enable both to be stored in a distributed manner within the specified federated area. Again, following such distributed storage, the processor may then store indications of aspects of the storage of the data object at **4124**.

[**0878**] FIGS. **35A**, **35B** and **35C**, together, illustrate an example embodiment of a logic flow **4200**. The logic flow **4200** may be representative of some or all of the operations executed by one or more embodiments described herein. More specifically, the logic flow **4200** may illustrate operations performed by the processor(s) **2550** or **2650** in execut-

ing one or more components of the control routine **2540**, and/or performed by other component(s) of at least one of the federated devices **2500** and/or at least one of the storage devices **2600**.

[**0879**] At **4210**, a processor of a federated device of a distributed processing system (e.g., at least one processor **2550** of one of the federated devices **2500** of the distributed processing system **2000**) may receive a request from a device, via a network (e.g., one of the source devices **2100** or one of the reviewing devices **2800** via the network **2999**) and through a portal provided by the processor, to perform a job flow with one or more data sets (e.g. one or more of the flow input data sets **2330**) specified in the request by a job flow identifier and one or more data object identifiers (e.g., one of the job flow identifiers **2221**, and one or more of the data object identifiers **2331**).

[**0880**] At **4212**, in embodiments in which the federated device(s) that provide federated area(s) also control access thereto, the processor may perform a check of whether the request is from an authorized device and/or from an authorized person or entity (e.g., scholastic, governmental or business entity) operating the device that is an authorized user of at least one federated area, and/or has been granted a level of access that includes the authorization to make such requests. As has been discussed, the processor may require the receipt of one or more security credentials from devices from which requests are received. If, at **4212**, the processor determines that the request is not from a device and/or user authorized to make such a request, then the processor may transmit an indication of denial of the request to the device via the network at **4214**.

[**0881**] However, if at **4212**, the processor determines that the request for a performance of the specified job flow with the specified one or more data sets is authorized, then at **4220**, the processor may use the one or more data object identifiers to access each data object and/or access stored information concerning each data object to determine the size of each.

[**0882**] At **4222**, if none of the one or more specified data objects is larger than a predetermined threshold size, or if there are multiple data objects among the one of the one or more specified data object that are larger than the predetermined threshold size, then at **4230**, the processor may retrieve the specified one or more data objects, along with other objects needed to perform the job flow (e.g., a job flow definition **2220** and one or more task routines **2440**) from a set of storage devices. At **4232**, the processor and/or other processing resources of the federated device and/or of one or more other federated devices may be used to perform the job flow, and the result of that performance may be transmitted to the requesting device at **4234**.

[**0883**] However, if at **4222**, there is a single data object among the one or more specified data objects that is larger than the predetermined threshold size, then at **4240**, the processor may retrieve the others of the one or more specified objects (if there are such others) from the set of storage devices in which they are stored, as well as other objects needed to perform the job flow from the set of storage devices. At **4242**, the processor may generate a container (e.g., the container **2565**) to include the retrieved other data object(s) (if there are any), the other objects required for performing the job flow, and one or more executable routines (e.g., a version of the performance routine **2544**) to be executed using processing resources of

the set of storage devices to enable performing the job flow using the processing resources of the set of storage devices.

[**0884**] At **4244**, the processor may provide copies of the container to the set of storage devices such that each storage device thereamong is provided with a copy of the container. At **4246**, processor(s) of each storage device (e.g., the processor **2650** of a storage device **2600**) of the set of storage devices that stores at least one data object block of the single large data set may execute the executable routine to then perform the job flow using the objects provided in the container, and using the locally stored data object block(s) of the single large data object as an input. As previously discussed, such performances by multiple storage devices within a set of storage devices may occur at least partially in parallel.

[**0885**] At **4250**, with the performances of the job flow over, the processor may retrieve, from each of the storage devices in the set of storage devices that performed the job flow, data object blocks of a result report generated as a result of the job flow performances. At **4252**, the processor may assemble the result report from the retrieved data object blocks, and may generate and assign a result report identifier for the result report at **4254**. The processor may then transmit the newly assembled result report to the requesting device at **4256**.

[**0886**] If, at **4260**, the size of the result report is not larger than a predetermined threshold size, then at **4262**, the processor may provide the result report to at least one storage device of the set of storage devices to be stored within a federated area as an undivided object within the storage space provided by a single one of the set of storage devices for that federated area. Again, as previously discussed, in some embodiments, the predetermined threshold size may be determined to be set to be equal to (or in some other way based on) the threshold size used by the set of storage devices to determine whether to divide a data object into multiple data object blocks.

[**0887**] However, if at **4260**, the size of the result report is larger than the predetermined threshold size, then at **4270**, the processor may check whether the result report is already in a distributable form. Again, a distributable form of a data object or result report may entail having no distinct metadata data structure (e.g., the metadata **2338**), and having the data items thereof organized into a single homogeneous data structure (e.g., the data items **2339** organized into a single homogeneous data structure **2335d**). Further, in some of such embodiments, there may be a limited preselected set of types of homogeneous data structure from which the type of the single homogeneous data structure is to be selected.

[**0888**] If, at **4270**, the result report is already in such a distributable form, then the processor may provide the result report to the set of storage devices to be divided up by the set of storage devices into multiple data object blocks (e.g., the data object blocks **7336d**) that are then stored in a distributed manner as by being distributed among the set of storage devices such that each data object block of the result report is stored within a portion of one of the storage devices that provides a portion of a distributed file system that spans multiple storage devices and in which a federated area has been defined to also span the multiple storage devices.

[**0889**] However, if at **4270**, the result report is not already in such a distributable form, then the processor may convert the result report from its original form and into a distributed

form at **4280**, before providing the distributable form to the set of storage devices at **4272**.

[**0890**] FIGS. **36A**, **36B** and **36C**, together, illustrate an example embodiment of a logic flow **4300**. The logic flow **4300** may be representative of some or all of the operations executed by one or more embodiments described herein. More specifically, the logic flow **4300** may illustrate operations performed by the processor(s) **2550** or **2650** in executing one or more components of the control routine **2540**, and/or performed by other component(s) of at least one of the federated devices **2500** and/or at least one of the storage devices **2600**.

[**0891**] At **4310**, a processor of a federated device of a distributed processing system (e.g., at least one processor **2550** of one of the federated devices **2500** of the distributed processing system **2000**) may receive a request from a device, via a network (e.g., one of the source devices **2100** or one of the reviewing devices **2800** via the network **2999**) and through a portal provided by the processor, to perform a one or more tasks specified in the request (e.g., with each task specified by its corresponding flow task identifier **2241**), and with one or more data objects specified in the request as inputs to each task (e.g. with each of one or more data objects **2330**, **2370** and/or **2770** to be used as inputs specified in the request as inputs for each task specified using corresponding data object identifiers **2331**, **2371** and/or **2771**, respectively).

[**0892**] At **4312**, in embodiments in which the federated device(s) that provide federated area(s) also control access thereto, the processor may perform a check of whether the request is from an authorized device and/or from an authorized person or entity (e.g., scholastic, governmental or business entity) operating the device that is an authorized user of at least one federated area, and/or has been granted a level of access that includes the authorization to make such requests. As has been discussed, the processor may require the receipt of one or more security credentials from devices from which requests are received. If, at **4312**, the processor determines that the request is not from a device and/or user authorized to make such a request, then the processor may transmit an indication of denial of the request to the device via the network at **4314**.

[**0893**] However, if at **4312**, the processor determines that the request for a performance of the specified job flow with the specified one or more data sets is authorized, then at **4320**, the processor may check whether there are any data objects embedded in the request. As has been discussed, it may be that the request is formatted in a manner conforming to at least one version of the MPI specification to at least the degree that it may embed one or more of the data objects that may be used as an input to at least one of the specified tasks as streaming data.

[**0894**] If, at **4320**, there are no data objects embedded within the request, then at **4340**, the processor may use the flow task identifiers (or whatever other type of identifier is used in the request for each task) to retrieve the most recent version of task routine for each task specified in the request. As has been discussed, in retrieving task routines, the processor may limit the federated areas from which it so retrieves task routines to those to which access is authorized.

[**0895**] At **4341**, the processor may identify dependencies among the tasks specified in request. As previously discussed, as part of identifying dependencies, the processor may analyze each instance of the specification of a data

object as an input to one of the specified tasks and/or as an output from one of the specified tasks to identify any instances in which a dependency exists among two or specified tasks as a result of a data object that is output by one of the specified tasks being used as an input to another of the specified tasks. Alternatively or additionally, the processor may analyze the input interfaces and output interfaces of each of the retrieved task routines to identify each instance of an output interface of one task routine that matches an input interface of another task routine, which may be an indication of a dependency therebetween. As also previously discussed, within each task routine, there may be comments that describe its input and/or output interfaces in addition to the executable instructions that implement each of those interfaces, and the processor may analyze either or both of such comments (if present) and such executable instructions.

[**0896**] Regardless of the exact manner in which the processor identifies dependencies, if, at **4343**, a dependency error is identified, then the processor may transmit an indication of denial of the request to the requesting device at **4345**. By way of example, it may be that the processor identifies an instance of a data object being specified as both an input to and an output of the same task, or of the same set of tasks, such that an impossible situation of a data object being needed as an input before it can possibly be created as an output is being specified in the request. Alternatively or additionally, where the processor has also analyzed interfaces of the task routines, it may be that an object is specified as an output of one task and an input to another task where the output interface for that output of that one task is incompatible with the input interface for that input of the other task.

[**0897**] However, if no dependency error exists at **4343**, at **4350**, the processor may employ the earlier derived dependencies to derive an order of performance of the tasks as part of generating a new job flow for the performance of the set of tasks of the request, and may check whether there are any opportunities for parallelism in the performance of the tasks at **4351**. If no such opportunities for parallelism exist, then at **4353**, the processor may generate a job flow definition for the performance of the set of tasks specified in the request that specifies an entirely serial performance of those specified tasks. However, if there is such an opportunity for parallelism at **4351**, then at **4354**, the processor may generate the job flow definition to specify each of the one or more opportunities for the parallel performance of two or more of those specified tasks. Regardless of whether an entirely serial job flow definition is generated at **4353** or a job flow definition that specifies one or more opportunities for parallelism is generated at **4354**, the resulting job flow definition may also be generated by the processor to specify aspects of input and/or output interfaces for each task by which data is received and/or output by each.

[**0898**] At **4356**, the processor may generate a job flow identifier (e.g., a job flow identifier **2221**) for the new job flow, and may incorporate the new job flow identifier **2221** into the newly generated job flow definition. At **4358**, the processor may store the job flow definition generated at either **4153** or **4154** within a federated area. At **4360**, the processor may then perform the job flow. In so doing, the processor may attempt to identify opportunities for parallelizing the performance of individual tasks that may be afforded by the an object specified as an input to a task

having been stored in distributed form such that multiple instances of that task may be performed at least partially in parallel with each block of that object.

[0899] However, if at 4320, there are one or more data objects embedded within the request, then at 4322, then the processor may generate and assign a data object identifier for each of the one or more embedded data objects at 4322.

[0900] At 4330, the processor may check if there are any of the one or more embedded data objects that are smaller than a predetermined threshold size. If there are, then at 4331, the processor may provide each of those smaller data objects to at least one storage device of a set of storage devices (e.g., one of the storage devices 2600a-x and/or 2600z), or to at least one federated device of a set of federated devices being used to store objects (e.g., one of the federated devices 2500a-x and/or 2500z), to be stored within a federated area as an undivided object within the storage space provided by a single one of those devices. As previously discussed, in some embodiments, the predetermined threshold size may be determined to be set to be equal to (or in some other way based on) the threshold size used by a set of storage devices, or a set of federated devices being used to store objects, to determine whether to divide a data object into multiple data object blocks.

[0901] At 4332, the processor may check if there are any of the one or more embedded data objects that are larger than the predetermined threshold size, and that are already in distributable form. As previously discussed, a distributable form of a data object may entail having no distinct metadata data structure (e.g., the metadata 2338), and having the data items thereof organized into a single homogeneous data structure (e.g., the data items 2339 organized into a single homogeneous data structure 2335d). Further, in some of such embodiments, there may be a limited preselected set of types of homogeneous data structure from which the type of the single homogeneous data structure is to be selected. If there are any such data objects at 4332, then at 4333, then the processor may provide each such data object to the set of storage devices, or to the set of federated devices being employed as a set of storage devices, to be divided up by that set of devices into multiple data object blocks (e.g., the data object blocks 2336d of a flow input data object 2330) that are then stored in a distributed manner as by being distributed among that set of devices such that each data object block is stored within a portion of one of the devices that provides a portion of a distributed file system that spans that set of devices and in which the specified federated area has been defined to also span that set of devices.

[0902] At 4334, the processor may check if there are any of the one or more embedded data objects that are larger than the predetermined threshold size, and that are not already in distributable form. If there are, then at 4335, the processor may convert each such data object from its non-distributable form and into a distributable form, before providing each such object in distributable form to the set of storage devices, or to the set of federated devices being employed as a set of storage devices, to be divided up by that set of devices into multiple data object blocks that are then stored in a distributed manner. At 4336, the processor may store indications of one or more characteristics of the original form (e.g., the metadata 2338) of each such object for future use in re-creating their original forms, before discarding their original forms at 4337. Alternatively, and as previously discussed, the processor may provide both the original and

distributable forms of each such data object to the set of devices to enable both to be stored in a distributed manner.

[0903] At 4338, the processor may also store indications of aspects of the storage of each data object that was received as embedded in the request (e.g., its size, whether stored as an undivided object or in a distributed manner, whether stored in distributable form (if applicable), the identity of the federated area in which it is stored and/or the identity of each device in which at least a portion of it is stored). Following the storage of such information for each such object, the processor may then proceed to retrieving the most recent version of task routine to perform each specified task at 4340.

[0904] In various embodiments, each of the processors 2150, 2550 and 2850 may include any of a wide variety of commercially available processors. Further, one or more of these processors may include multiple processors, a multi-threaded processor, a multi-core processor (whether the multiple cores coexist on the same or separate dies), and/or a multi-processor architecture of some other variety by which multiple physically separate processors are linked.

[0905] However, in a specific embodiment, the processor 2550 of each of the one or more federated devices 1500 may be selected to efficiently perform the analysis of multiple instances of job flows at least partially in parallel. By way of example, the processor 2550 may incorporate a single-instruction multiple-data (SIMD) architecture, may incorporate multiple processing pipelines, and/or may incorporate the ability to support multiple simultaneous threads of execution per processing pipeline. Alternatively or additionally by way of example, the processor 1550 may incorporate multi-threaded capabilities and/or multiple processor cores to enable parallel performances of the tasks of more than job flow.

[0906] In various embodiments, each of the control routines 2140, 2540 and 2840, including the components of which each is composed, may be selected to be operative on whatever type of processor or processors that are selected to implement applicable ones of the processors 2150, 2550 and/or 2850 within each one of the devices 2100, 2500 and/or 2800, respectively. In various embodiments, each of these routines may include one or more of an operating system, device drivers and/or application-level routines (e.g., so-called “software suites” provided on disc media, “applets” obtained from a remote server, etc.). Where an operating system is included, the operating system may be any of a variety of available operating systems appropriate for the processors 2150, 2550 and/or 2850. Where one or more device drivers are included, those device drivers may provide support for any of a variety of other components, whether hardware or software components, of the devices 2100, 2500 and/or 2800.

[0907] In various embodiments, each of the storages 2160, 2560 and 2860 may be based on any of a wide variety of information storage technologies, including volatile technologies requiring the uninterrupted provision of electric power, and/or including technologies entailing the use of machine-readable storage media that may or may not be removable. Thus, each of these storages may include any of a wide variety of types (or combination of types) of storage device, including without limitation, read-only memory (ROM), random-access memory (RAM), dynamic RAM (DRAM), Double-Data-Rate DRAM (DDR-DRAM), synchronous DRAM (SDRAM), static RAM (SRAM), pro-

grammable ROM (PROM), erasable programmable ROM (EPROM), electrically erasable programmable ROM (EEPROM), flash memory, polymer memory (e.g., ferroelectric polymer memory), ovonic memory, phase change or ferroelectric memory, silicon-oxide-nitride-oxide-silicon (SONOS) memory, magnetic or optical cards, one or more individual ferromagnetic disk drives, non-volatile storage class memory, or a plurality of storage devices organized into one or more arrays (e.g., multiple ferromagnetic disk drives organized into a Redundant Array of Independent Disks array, or RAID array). It should be noted that although each of these storages is depicted as a single block, one or more of these may include multiple storage devices that may be based on differing storage technologies. Thus, for example, one or more of each of these depicted storages may represent a combination of an optical drive or flash memory card reader by which programs and/or data may be stored and conveyed on some form of machine-readable storage media, a ferromagnetic disk drive to store programs and/or data locally for a relatively extended period, and one or more volatile solid state memory devices enabling relatively quick access to programs and/or data (e.g., SRAM or DRAM). It should also be noted that each of these storages may be made up of multiple storage components based on identical storage technology, but which may be maintained separately as a result of specialization in use (e.g., some DRAM devices employed as a main storage while other DRAM devices employed as a distinct frame buffer of a graphics controller).

[0908] However, in a specific embodiment, the storage **2560** in embodiments in which the one or more of the federated devices **2500** provide federated spaces **2566**, or the storage devices **2600** in embodiments in which the one or more storage devices **2600** provide federated spaces **2566**, may be implemented with a redundant array of independent discs (RAID) of a RAID level selected to provide fault tolerance to objects stored within the federated spaces **2566**.

[0909] In various embodiments, each of the input devices **2110** and **2810** may each be any of a variety of types of input device that may each employ any of a wide variety of input detection and/or reception technologies. Examples of such input devices include, and are not limited to, microphones, remote controls, stylus pens, card readers, finger print readers, virtual reality interaction gloves, graphical input tablets, joysticks, keyboards, retina scanners, the touch input components of touch screens, trackballs, environmental sensors, and/or either cameras or camera arrays to monitor movement of persons to accept commands and/or data provided by those persons via gestures and/or facial expressions.

[0910] In various embodiments, each of the displays **2180** and **2880** may each be any of a variety of types of display device that may each employ any of a wide variety of visual presentation technologies. Examples of such a display device includes, and is not limited to, a cathode-ray tube (CRT), an electroluminescent (EL) panel, a liquid crystal display (LCD), a gas plasma display, etc. In some embodiments, the displays **2180** and/or **2880** may each be a touchscreen display such that the input devices **2110** and/or **2810**, respectively, may be incorporated therein as touch-sensitive components thereof.

[0911] In various embodiments, each of the network interfaces **2190**, **2590** and **2890** may employ any of a wide variety of communications technologies enabling these devices to be coupled to other devices as has been described. Each of these interfaces includes circuitry providing at least

some of the requisite functionality to enable such coupling. However, each of these interfaces may also be at least partially implemented with sequences of instructions executed by corresponding ones of the processors (e.g., to implement a protocol stack or other features). Where electrically and/or optically conductive cabling is employed, these interfaces may employ timings and/or protocols conforming to any of a variety of industry standards, including without limitation, RS-232C, RS-422, USB, Ethernet (IEEE-802.3) or IEEE-1394. Where the use of wireless transmissions is entailed, these interfaces may employ timings and/or protocols conforming to any of a variety of industry standards, including without limitation, IEEE 802.11a, 802.11ad, 802.11ah, 802.11ax, 802.11b, 802.11g, 802.16, 802.20 (commonly referred to as "Mobile Broadband Wireless Access"); Bluetooth; ZigBee; or a cellular radio-telephone service such as GSM with General Packet Radio Service (GSM/GPRS), CDMA/1×RTT, Enhanced Data Rates for Global Evolution (EDGE), Evolution Data Only/Optimized (EV-DO), Evolution For Data and Voice (EV-DV), High Speed Downlink Packet Access (HSDPA), High Speed Uplink Packet Access (HSUPA), 4G LTE, 5G, etc. [0912] However, in a specific embodiment, one or more of the network interfaces **2190**, **2590** and/or **2890** may be implemented with multiple copper-based or fiber-optic based network interface ports to provide redundant and/or parallel pathways in exchanging one or more of the data sets **2330** and/or **2370**.

[0913] In various embodiments, the division of processing and/or storage resources among the federated devices **1500**, and/or the API architectures employed to support communications between the federated devices and other devices may be configured to and/or selected to conform to any of a variety of standards for distributed processing, including without limitation, IEEE P2413, AllJoyn, IoTivity, etc. By way of example, a subset of API and/or other architectural features of one or more of such standards may be employed to implement the relatively minimal degree of coordination described herein to provide greater efficiency in parallelizing processing of data, while minimizing exchanges of coordinating information that may lead to undesired instances of serialization among processes. However, it should be noted that the parallelization of storage, retrieval and/or processing of portions of the data sets **2330** and/or **2370** are not dependent on, nor constrained by, existing API architectures and/or supporting communications protocols. More broadly, there is nothing in the manner in which the data sets **2330** and/or **2370** may be organized in storage, transmission and/or distribution via the network **2999** that is bound to existing API architectures or protocols.

[0914] Some systems may use Hadoop®, an open-source framework for storing and analyzing big data in a distributed computing environment. Some systems may use cloud computing, which can enable ubiquitous, convenient, on-demand network access to a shared pool of configurable computing resources (e.g., networks, servers, storage, applications and services) that can be rapidly provisioned and released with minimal management effort or service provider interaction. Some grid systems may be implemented as a multi-node Hadoop® cluster, as understood by a person of skill in the art. Apache™ Hadoop® is an open-source software framework for distributed computing.

1. An apparatus comprising at least one processor and a storage to store instructions that, when executed by the at

least one processor, cause the at least one processor to perform operations comprising:

receive, at the at least one processor, and from a requesting device via a network, a request to perform a job flow, wherein:

the job flow is defined in a job flow definition that specifies a set of tasks to be performed via execution of a corresponding set of task routines during a performance of the job flow, and that specifies data dependencies among the set of task routines; and
the set of task routines are executed within a set of task containers instantiated within at least one virtual machine (VM);

store, within a job queue, a job performance request message comprising an indication of receiving the request to perform the job flow; and

within a performance container, execute instructions of a performance routine to cause the at least one processor to, in response to the storage of the job performance request message within the job queue, perform operations comprising:

based on the data dependencies among the set of tasks specified in the job flow definition, derive an order of performance of the set of tasks that specifies a subset of tasks of the set of tasks that are able to be performed in parallel, and derive a quantity of task containers within the set of task containers that enables parallel execution of a corresponding subset of task routines to cause the parallel performance of the subset of tasks;

based on at least the derived quantity of task containers within the set of task containers, derive a quantity of at least one other VM that, in combination with the at least one VM, provides resources to enable instantiation of the derived quantity of task containers to enable the parallel execution of the subset of task routines;

provide, to a VM allocation routine executed by the at least one processor, an indication of a need for provision of the at least one other VM, wherein execution of the VM allocation routine causes the at least one processor to allocate the at least one VM; and

store, within a task queue, multiple task routine execution request messages that each comprise an identifier associated with a task of the subset of tasks to enable the parallel execution of the subset of task routines within the set of task containers.

2. The apparatus of claim 1, wherein the at least one processor is caused to perform operations comprising:

within the performance container, in response to at least storage of multiple execution completion messages within the task queue that are indicative of completion of execution of the subset of task routines, perform operations comprising:

provide, to the VM allocation routine, an indication of cessation of the need for provision of the at least one other VM, wherein, the provision of the at least one other VM comprises at least one of instantiating a VM of the at least one other VM, or providing access to a VM of the at least one other VM.

3. The apparatus of claim 1, wherein:

the allocation of the at least one VM comprises allocation of at least one of processing resources or storage resources provided within at least one node device; and

the provision of the at least one other VM comprises a further allocation of the at least one of the processing resources or storage resources provided within the at least one node device.

4. The apparatus of claim 3, wherein:

the job flow definition indicates that a task of the subset of tasks is of a task type that requires access to a particular resource that is provided by less than all node devices of the at least one node device; and

in executing the VM allocation routine, and in response to the indication that a task of the subset of tasks is of the task type, the at least one processor is caused to perform operations comprising:

analyze resources provided by each node device of the at least one node device to identify a node device that provides the particular resource; and
provide a VM of the at least one other VM that is instantiated within the identified node device.

5. The apparatus of claim 4, wherein:

the at least one processor executes a resource allocation routine that causes the at least one processor to dynamically allocate multiple containers based on availability of resources within each VM of the at least one VM; and

in executing the resource allocation routine, and in response to the indication that a task of the subset of tasks is of the task type, the at least one processor is caused to perform operations comprising:

analyze resources provided by each VM of the at least one VM and of the at least one other VM to identify a VM that provides the particular resource; and
provide a task container of the set of task containers that is instantiated within the identified VM.

6. The apparatus of claim 4, wherein the at least one processor is caused to perform operations comprising:

within each task container of the set of task containers, in response to the storage of a task routine execution request message within the task queue, analyze an identifier of the task type within the task routine execution request message to determine whether the task container supports a performance of a task of the task type; and

in response to a determination that the task container supports the performance of a task of the task type, perform operations comprising:

use an identifier of a task provided in the task routine execution request message to retrieve a corresponding task routine; and

execute the retrieved corresponding task routine to cause the performance of the identified task.

7. The apparatus of claim 1, wherein the at least one processor is caused to perform operations comprising:

provide, to a resource allocation routine executed by the at least one processor, an indication of a need for provision of the derived quantity of task containers, wherein execution of the resource allocation routine causes the at least one processor to dynamically allocate multiple containers based on availability of at least one of processing resources or storage resources within the at least one VM.

8. The apparatus of claim 7, wherein the at least one processor delays the provision, to the resource allocation routine, of the indication of the need for the provision of the derived quantity of task containers by a predetermined

amount of time after the provision, to the VM allocation routine, of the indication of the need for provision of the at least one other VM to cause the provision of the resources to enable the instantiation of the quantity of task containers.

9. The apparatus of claim 7, wherein the at least one processor is caused to perform operations comprising:

within the performance container, in response to at least storage of multiple execution completion messages within the task queue that are indicative of completion of execution of the subset of task routines, perform operations comprising:

provide, to the resource allocation routine, an indication of cessation of the need for provision of the derived quantity of task containers.

10. The apparatus of claim 7, wherein:

the dynamic allocation of the multiple containers comprises dynamic allocation of multiple pods based on the availability of the at least one of processing resources or storage resources within the at least one VM;

the performance container and a messaging container are instantiated within a performance pod of the multiple pods; and

within the messaging container, instructions of an instance of a messaging routine are executed by the at least one processor to cause the at least one processor to provide the instance of the performance routine with access to the job queue and the task queue.

11. A computer-program product tangibly embodied in a non-transitory machine-readable storage medium, the computer-program product including instructions operable to cause at least one processor to perform operations comprising:

receive, at the at least one processor, and from a requesting device via a network, a request to perform a job flow, wherein:

the job flow is defined in a job flow definition that specifies a set of tasks to be performed via execution of a corresponding set of task routines during a performance of the job flow, and that specifies data dependencies among the set of task routines; and
the set of task routines are executed within a set of task containers instantiated within at least one virtual machine (VM);

store, within a job queue, a job performance request message comprising an indication of receiving the request to perform the job flow; and

within a performance container, execute instructions of a performance routine to cause the at least one processor to, in response to the storage of the job performance request message within the job queue, perform operations comprising:

based on the data dependencies among the set of tasks specified in the job flow definition, derive an order of performance of the set of tasks that specifies a subset of tasks of the set of tasks that are able to be performed in parallel, and derive a quantity of task containers within the set of task containers that enables parallel execution of a corresponding subset of task routines to cause the parallel performance of the subset of tasks;

based on at least the derived quantity of task containers within the set of task containers, derive a quantity of at least one other VM that, in combination with the at least one VM, provides resources to enable instan-

tiation of the derived quantity of task containers to enable the parallel execution of the subset of task routines;

provide, to a VM allocation routine executed by the at least one processor, an indication of a need for provision of the at least one other VM, wherein execution of the VM allocation routine causes the at least one processor to allocate the at least one VM; and

store, within a task queue, multiple task routine execution request messages that each comprise an identifier associated with a task of the subset of tasks to enable the parallel execution of the subset of task routines within the set of task containers.

12. The computer-program product of claim 11, wherein the at least one processor is caused to perform operations comprising:

within the performance container, in response to at least storage of multiple execution completion messages within the task queue that are indicative of completion of execution of the subset of task routines, perform operations comprising:

provide, to the VM allocation routine, an indication of cessation of the need for provision of the at least one other VM, wherein, the provision of the at least one other VM comprises at least one of instantiating a VM of the at least one other VM, or providing access to a VM of the at least one other VM.

13. The computer-program product of claim 11, wherein: the allocation of the at least one VM comprises allocation of at least one of processing resources or storage resources provided within at least one node device; and the provision of the at least one other VM comprises a further allocation of the at least one of the processing resources or storage resources provided within the at least one node device.

14. The computer-program product of claim 13, wherein: the job flow definition indicates that a task of the subset of tasks is of a task type that requires access to a particular resource that is provided by less than all node devices of the at least one node device; and

in executing the VM allocation routine, and in response to the indication that a task of the subset of tasks is of the task type, the at least one processor is caused to perform operations comprising:

analyze resources provided by each node device of the at least one node device to identify a node device that provides the particular resource; and

provide a VM of the at least one other VM that is instantiated within the identified node device.

15. The computer-program product of claim 14, wherein: the at least one processor executes a resource allocation routine that causes the at least one processor to dynamically allocate multiple containers based on availability of resources within each VM of the at least one VM; and

in executing the resource allocation routine, and in response to the indication that a task of the subset of tasks is of the task type, the at least one processor is caused to perform operations comprising:

analyze resources provided by each VM of the at least one VM and of the at least one other VM to identify a VM that provides the particular resource; and

- provide a task container of the set of task containers that is instantiated within the identified VM.
- 16.** The computer-program product of claim **14**, wherein the at least one processor is caused to perform operations comprising:
- within each task container of the set of task containers, in response to the storage of a task routine execution request message within the task queue, analyze an identifier of the task type within the task routine execution request message to determine whether the task container supports a performance of a task of the task type; and
 - in response to a determination that the task container supports the performance of a task of the task type, perform operations comprising:
 - use an identifier of a task provided in the task routine execution request message to retrieve a corresponding task routine; and
 - execute the retrieved corresponding task routine to cause the performance of the identified task.
- 17.** The computer-program product of claim **11**, wherein the at least one processor is caused to perform operations comprising:
- provide, to a resource allocation routine executed by the at least one processor, an indication of a need for provision of the derived quantity of task containers, wherein execution of the resource allocation routine causes the at least one processor to dynamically allocate multiple containers based on availability of at least one of processing resources or storage resources within the at least one VM.
- 18.** The computer-program product of claim **17**, wherein the at least one processor delays the provision, to the resource allocation routine, of the indication of the need for the provision of the derived quantity of task containers by a predetermined amount of time after the provision, to the VM allocation routine, of the indication of the need for provision of the at least one other VM to cause the provision of the resources to enable the instantiation of the quantity of task containers.
- 19.** The computer-program product of claim **17**, wherein the at least one processor is caused to perform operations comprising:
- within the performance container, in response to at least storage of multiple execution completion messages within the task queue that are indicative of completion of execution of the subset of task routines, perform operations comprising:
 - provide, to the resource allocation routine, an indication of cessation of the need for provision of the derived quantity of task containers.
- 20.** The computer-program product of claim **17**, wherein: the dynamic allocation of the multiple containers comprises dynamic allocation of multiple pods based on the availability of the at least one of processing resources or storage resources within the at least one VM; the performance container and a messaging container are instantiated within a performance pod of the multiple pods; and
- within the messaging container, instructions of an instance of a messaging routine are executed by the at least one processor to cause the at least one processor to provide the instance of the performance routine with access to the job queue and the task queue.
- 21.** A computer-implemented method comprising: receiving, by at least one processor, and from a requesting device via a network, a request to perform a job flow, wherein:
- the job flow is defined in a job flow definition that specifies a set of tasks to be performed via execution of a corresponding set of task routines during a performance of the job flow, and that specifies data dependencies among the set of task routines; and
 - the set of task routines are executed within a set of task containers instantiated within at least one virtual machine (VM);
- storing, within a job queue, a job performance request message comprising an indication of receiving the request to perform the job flow; and
- within a performance container, executing, by the at least one processor, instructions of a performance routine to cause the at least one processor to, in response to the storage of the job performance request message within the job queue, perform operations comprising:
- based on the data dependencies among the set of tasks specified in the job flow definition, deriving, by the at least one processor, an order of performance of the set of tasks that specifies a subset of tasks of the set of tasks that are able to be performed in parallel, and deriving, by the at least one processor, a quantity of task containers within the set of task containers that enables parallel execution of a corresponding subset of task routines to cause the parallel performance of the subset of tasks;
 - based on at least the derived quantity of task containers within the set of task containers, deriving, by the at least one processor, a quantity of at least one other VM that, in combination with the at least one VM, provides resources to enable instantiation of the derived quantity of task containers to enable the parallel execution of the subset of task routines;
 - providing, to a VM allocation routine executed by the at least one processor, an indication of a need for provision of the at least one other VM, wherein execution of the VM allocation routine causes the at least one processor to allocate the at least one VM; and
 - storing, within a task queue, multiple task routine execution request messages that each comprise an identifier associated with a task of the subset of tasks to enable the parallel execution of the subset of task routines within the set of task containers.
- 22.** The computer-implemented method of claim **21**, comprising:
- within the performance container, in response to at least storage of multiple execution completion messages within the task queue that are indicative of completion of execution of the subset of task routines, performing operations comprising:
 - providing, to the VM allocation routine, an indication of cessation of the need for provision of the at least one other VM, wherein, the provision of the at least one other VM comprises at least one of instantiating a VM of the at least one other VM, or providing access to a VM of the at least one other VM.
- 23.** The computer-implemented method of claim **21**, wherein:

the allocation of the at least one VM comprises allocation of at least one of processing resources or storage resources provided within at least one node device; and the provision of the at least one other VM comprises a further allocation of the at least one of the processing resources or storage resources provided within the at least one node device.

24. The computer-implemented method of claim **23**, wherein:

the job flow definition indicates that a task of the subset of tasks is of a task type that requires access to a particular resource that is provided by less than all node devices of the at least one node device; and

the method comprises, in executing the VM allocation routine, and in response to the indication that a task of the subset of tasks is of the task type, performing operations comprising:

analyzing, by the at least one processor, resources provided by each node device of the at least one node device to identify a node device that provides the particular resource; and

providing a VM of the at least one other VM that is instantiated within the identified node device.

25. The computer-implemented method of claim **24**, wherein:

the at least one processor executes a resource allocation routine that causes the at least one processor to dynamically allocate multiple containers based on availability of resources within each VM of the at least one VM; and

the method comprises, in executing the resource allocation routine, and in response to the indication that a task of the subset of tasks is of the task type, performing operations comprising:

analyzing, by the at least one processor, resources provided by each VM of the at least one VM and of the at least one other VM to identify a VM that provides the particular resource; and

providing a task container of the set of task containers that is instantiated within the identified VM.

26. The computer-implemented method of claim **24**, comprising:

within each task container of the set of task containers, in response to the storage of a task routine execution request message within the task queue, analyzing, by the at least one processor, an identifier of the task type within the task routine execution request message to determine whether the task container supports a performance of a task of the task type; and

in response to a determination that the task container supports the performance of a task of the task type, performing operations comprising:

using an identifier of a task provided in the task routine execution request message to retrieve a corresponding task routine; and

executing, by the at least one processor, the retrieved corresponding task routine to cause the performance of the identified task.

27. The computer-implemented method of claim **21**, comprising:

providing, to a resource allocation routine executed by the at least one processor, an indication of a need for provision of the derived quantity of task containers, wherein execution of the resource allocation routine causes the at least one processor to dynamically allocate multiple containers based on availability of at least one of processing resources or storage resources within the at least one VM.

28. The computer-implemented method of claim **27**, comprising delaying the provision, to the resource allocation routine, of the indication of the need for the provision of the derived quantity of task containers by a predetermined amount of time after the provision, to the VM allocation routine, of the indication of the need for provision of the at least one other VM to cause the provision of the resources to enable the instantiation of the quantity of task containers.

29. The computer-implemented method of claim **27**, comprising:

within the performance container, in response to at least storage of multiple execution completion messages within the task queue that are indicative of completion of execution of the subset of task routines, performing operations comprising:

providing, to the resource allocation routine, an indication of cessation of the need for provision of the derived quantity of task containers.

30. The computer-implemented method of claim **27**, wherein:

the dynamic allocation of the multiple containers comprises dynamic allocation of multiple pods based on the availability of the at least one of processing resources or storage resources within the at least one VM;

the performance container and a messaging container are instantiated within a performance pod of the multiple pods; and

within the messaging container, instructions of an instance of a messaging routine are executed by the at least one processor to cause the at least one processor to provide the instance of the performance routine with access to the job queue and the task queue.

* * * * *