



(19) **United States**

(12) **Patent Application Publication**
CAO et al.

(10) **Pub. No.: US 2018/0351710 A1**

(43) **Pub. Date: Dec. 6, 2018**

(54) **SIGNAL FIELD LENGTH INDICATION IN A HIGH EFFICIENCY WIRELESS LOCAL AREA NETWORK (WLAN)**

(71) Applicant: **Marvell World Trade Ltd.**, St. Michael (BB)

(72) Inventors: **Rui CAO**, Fremont, CA (US); **Xiayu ZHENG**, San Jose, CA (US); **Hongyuan ZHANG**, Fremont, CA (US)

(21) Appl. No.: **16/055,743**

(22) Filed: **Aug. 6, 2018**

Related U.S. Application Data

(63) Continuation of application No. 14/688,884, filed on Apr. 16, 2015, now Pat. No. 10,044,476.

(60) Provisional application No. 62/138,148, filed on Mar. 25, 2015, provisional application No. 62/114,232, filed on Feb. 10, 2015, provisional application No. 62/012,930, filed on Jun. 16, 2014, provisional application No. 61/980,417, filed on Apr. 16, 2014.

Publication Classification

(51) **Int. Cl.**
H04L 5/00 (2006.01)
H04L 27/26 (2006.01)
H04B 7/12 (2006.01)
(52) **U.S. Cl.**
CPC *H04L 5/0007* (2013.01); *H04L 27/261* (2013.01); *H04L 27/2607* (2013.01); *H04B 7/12* (2013.01)

(57) **ABSTRACT**

A first set of orthogonal frequency domain multiplexing (OFDM) symbols for a first portion of a PHY data unit and a second set of OFDM symbols for a second portion of the PHY data unit are generated. OFDM symbols of the first set are generated with a first OFDM tone spacing. At least some OFDM symbols of the second set are generated with a second tone spacing different from the first tone spacing. A value for a length indicator indicative of a duration of the PHY data unit is determined based on the first tone spacing and the second tone spacing. The first portion of the PHY data unit is generated to include (i) the first set of OFDM symbols and (ii) the length indicator set to the determined value. The second portion of the PHY data unit is generated to include the second set of OFDM symbols.

200 ↘

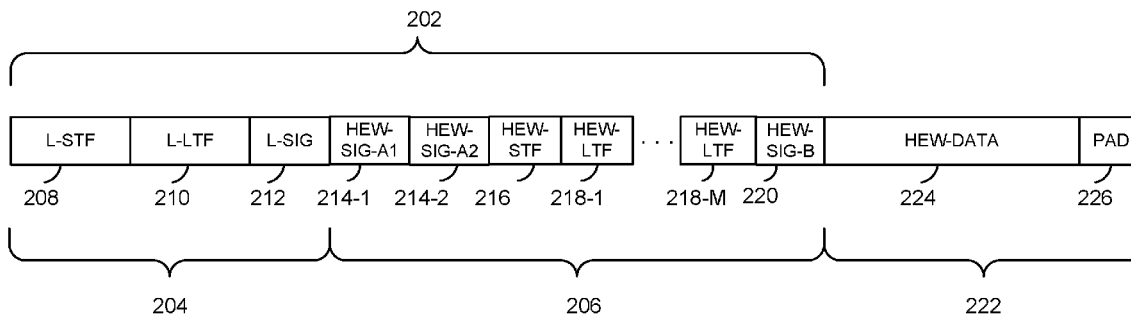
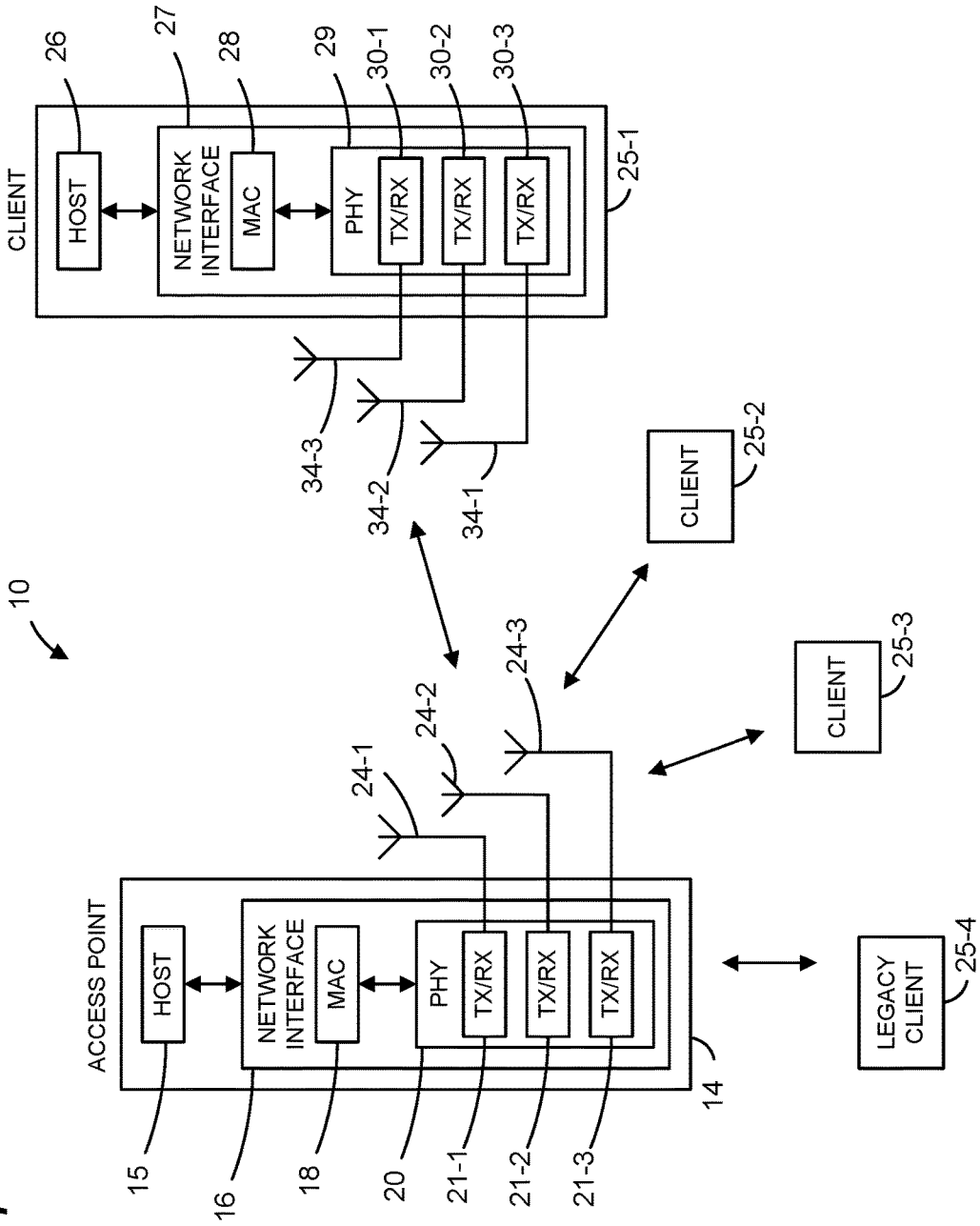

FIG. 1



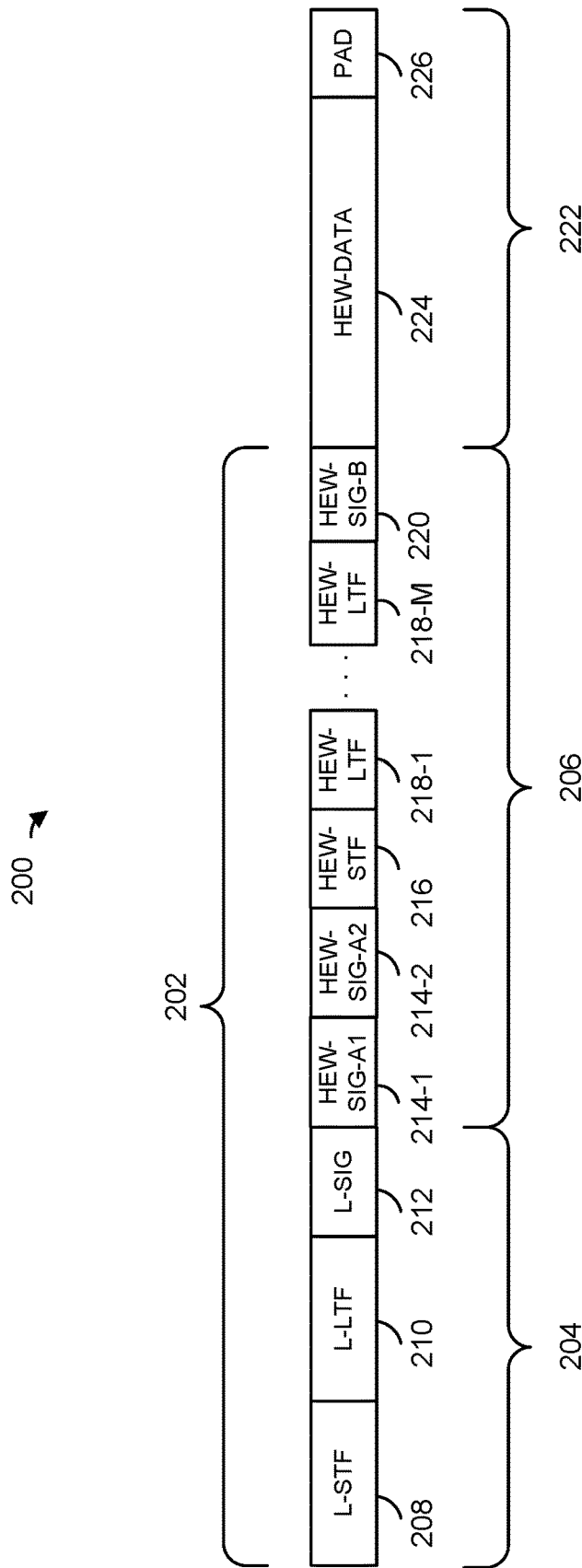

FIG. 2

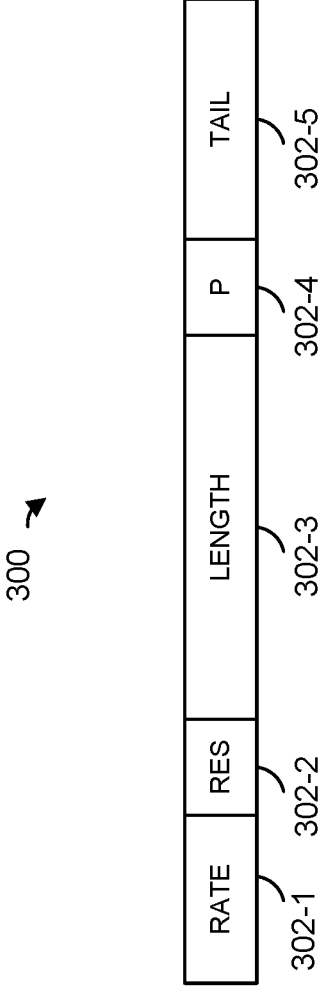

FIG. 3

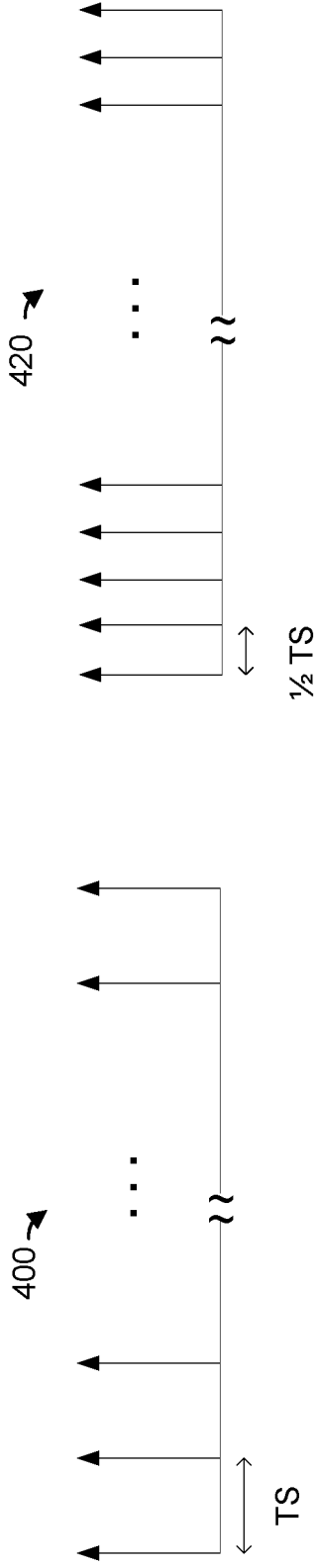

FIG. 4B

FIG. 4A

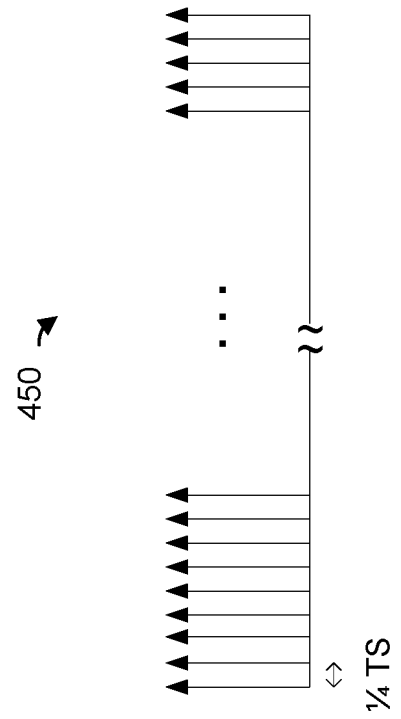

FIG. 4C

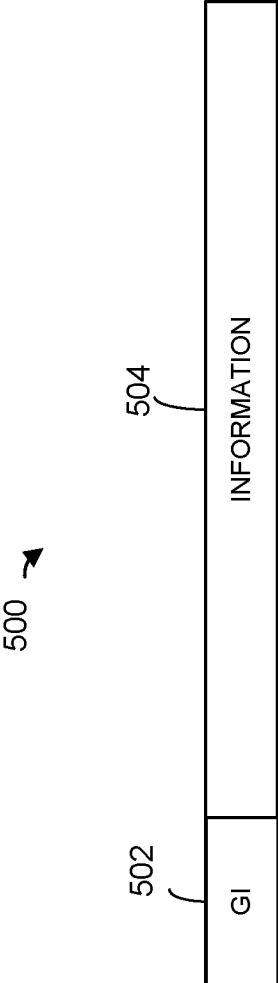

FIG. 5

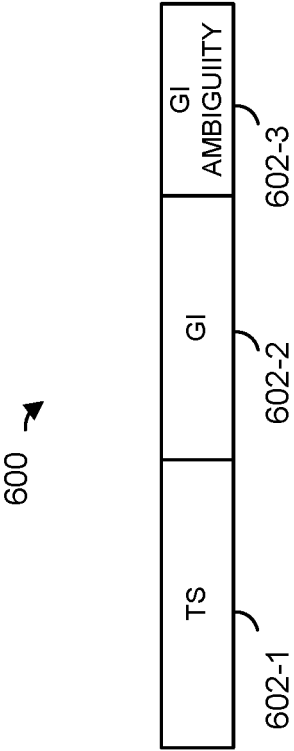

FIG. 6

700 →

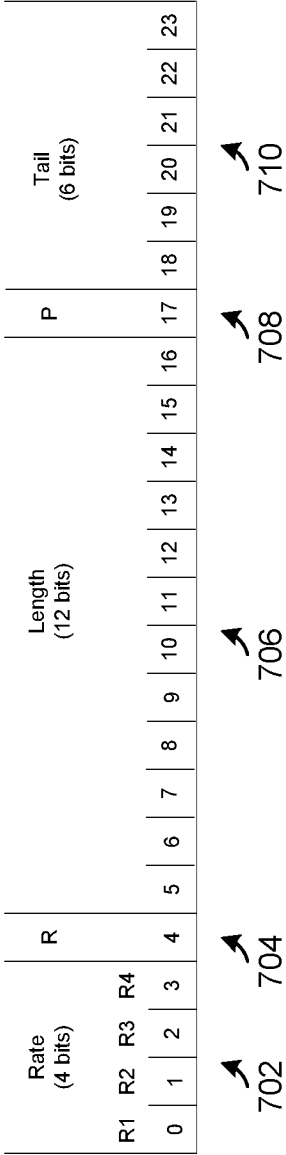

FIG. 7

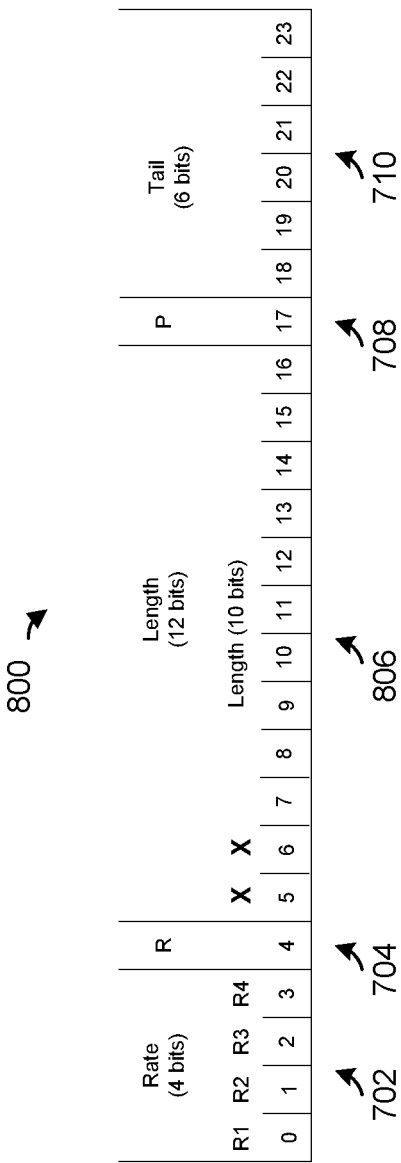

FIG. 8

FIG. 9

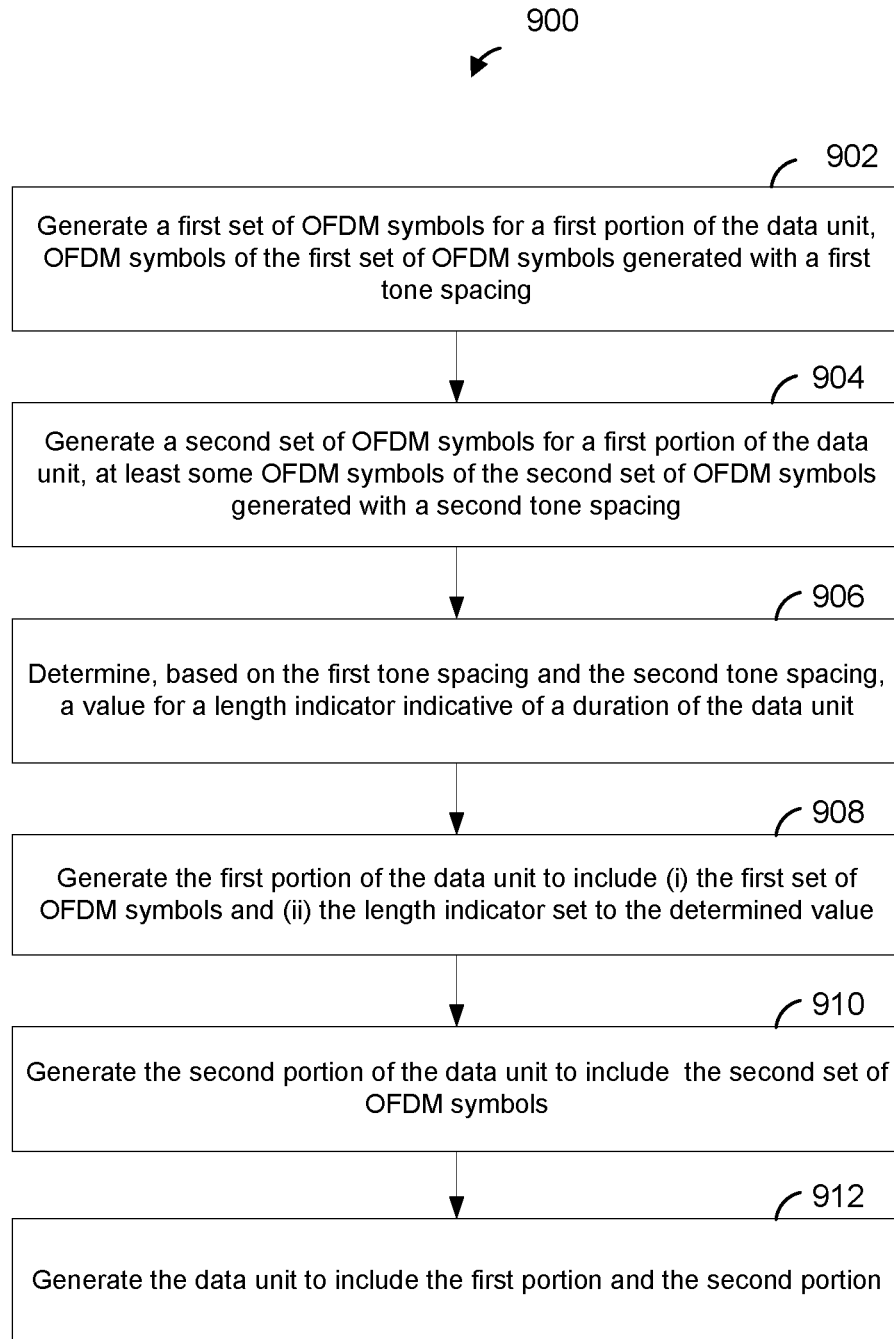
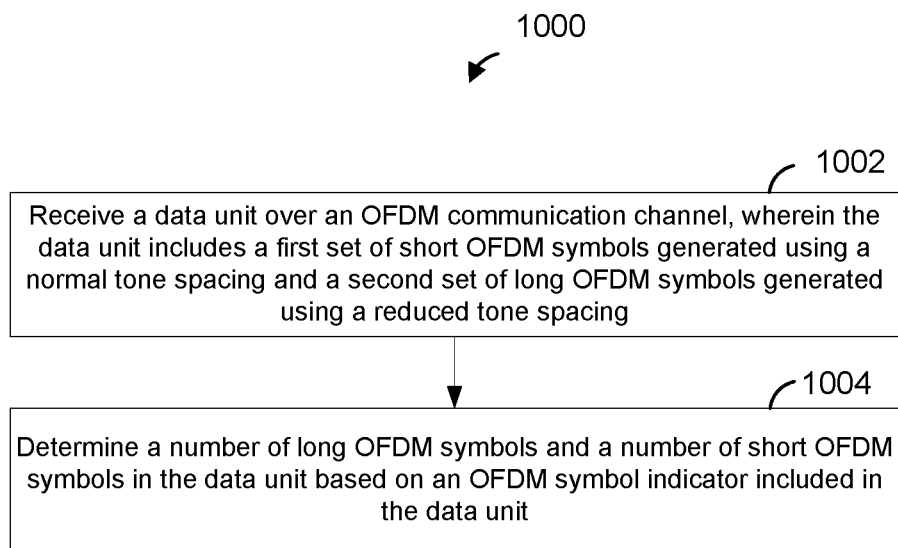

FIG. 10



**SIGNAL FIELD LENGTH INDICATION IN A
HIGH EFFICIENCY WIRELESS LOCAL
AREA NETWORK (WLAN)**

**CROSS-REFERENCES TO RELATED
APPLICATIONS**

[0001] This application is a continuation of U.S. patent application Ser. No. 14/688,884, now U.S. Pat. No. 10,044, 476, entitled “Signal Field Length Indication in a High Efficiency Wireless Local Area Network (WLAN),” filed on Apr. 16, 2015, which claims the benefit of U.S. Provisional Patent Application No. 61/980,417, entitled “L-SIG LENGTH Field Design for HEW,” filed on Apr. 16, 2014, U.S. Provisional Patent Application No. 62/012,930, entitled “L-SIG LENGTH Field Design for HEW,” filed on Jun. 16, 2014, U.S. Provisional Patent Application No. 62/114,232, entitled “L-SIG LENGTH Field Design for HEW,” filed on Feb. 10, 2015, and U.S. Provisional Patent Application No. 62/138,148, entitled “L-SIG LENGTH Field Design for HEW,” filed on Mar. 25, 2015. All of the applications referenced above are incorporated herein by reference in their entireties.

[0002] The present application is also related to U.S. patent application Ser. No. 14/688,859, entitled “Signal Field Length Indication in a High Efficiency Wireless Local Area Network (WLAN),” filed on Apr. 16, 2015, which is incorporated by reference herein in its entirety.

FIELD OF THE DISCLOSURE

[0003] The present disclosure relates generally to communication networks and, more particularly, to wireless local area networks that utilize orthogonal frequency division multiplexing (OFDM).

BACKGROUND

[0004] When operating in an infrastructure mode, wireless local area networks (WLANs) typically include an access point (AP) and one or more client stations. WLANs have evolved rapidly over the past decade. Development of WLAN standards such as the Institute for Electrical and Electronics Engineers (IEEE) 802.11a, 802.11b, 802.11g, and 802.11n Standards has improved single-user peak data throughput. For example, the IEEE 802.11b Standard specifies a single-user peak throughput of 11 megabits per second (Mbps), the IEEE 802.11a and 802.11g Standards specify a single-user peak throughput of 54 Mbps, the IEEE 802.11n Standard specifies a single-user peak throughput of 600 Mbps, and the IEEE 802.11ac Standard specifies a single-user peak throughput in the gigabits per second (Gbps) range. Future standards promise to provide even greater throughputs, such as throughputs in the tens of Gbps range.

SUMMARY

[0005] In an embodiment, a method for generating a physical layer (PHY) data unit for transmission via a communication channel includes generating a first set of orthogonal frequency domain multiplexing (OFDM) symbols for a first portion of the PHY data unit, wherein OFDM symbols of the first set of OFDM symbols are generated with a first OFDM tone spacing, and generating a second set of OFDM symbols for a second portion of the PHY data unit, wherein at least some OFDM symbols of the second set of OFDM symbols are generated with a second tone spacing

different from the first tone spacing. The method further includes determining, based on the first tone spacing and the second tone spacing, a value for a length indicator indicative of a duration of the PHY data unit. The method further still includes generating the first portion of the PHY data unit to include (i) the first set of OFDM symbols and (ii) the length indicator set to the determined value, and generating the second portion of the PHY data unit to include the second set of OFDM symbols. The method additionally includes generating the PHY data unit to include the first portion and the second portion.

[0006] In another embodiment, an apparatus comprises a network interface configured to generate a first set of orthogonal frequency domain multiplexing (OFDM) symbols for a first portion of a physical layer (PHY) data unit, wherein OFDM symbols of the first set of OFDM symbols are generated with a first OFDM tone spacing, and generate a second set of OFDM symbols for a second portion of the PHY data unit, wherein at least some OFDM symbols of the second set of OFDM symbols are generated with a second tone spacing different from the first tone spacing. The network interface is further configured to determine, based on the first tone spacing and the second tone spacing, a value for a length indicator indicative of a duration of the PHY data unit. The network interface is further still configured to generate the first portion of the PHY data unit to include (i) the first set of OFDM symbols and (ii) the length indicator set to the determined value, and generate the second portion of the PHY data unit to include the second set of OFDM symbols. The network interface is additionally configured to generate the PHY data unit to include the first portion and the second portion.

[0007] In yet another embodiment, a method for processing a physical layer (PHY) data unit includes receiving the PHY data unit via an orthogonal frequency division multiplexing (OFDM) communication channel. The PHY data unit includes (i) a first set of one or more short OFDM symbols generated using a normal tone spacing and (ii) a second set of one or more long OFDM symbols generated using a reduced tone spacing, (iii) an OFDM symbol indicator indicative of a number of OFDM symbols in at least one of (a) the first set of OFDM symbols and (b) the second set of OFDM symbols; The method additionally includes determining, based at least in part on the OFDM symbol indicator, (i) a number of short OFDM symbols in the set of one or more short OFDM symbols and (ii) a number of long OFDM symbols in the set of one or more long OFDM symbols.

[0008] In still another embodiment, an apparatus comprises a network interface configured to receive a physical layer (PHY) data unit via an orthogonal frequency division multiplexing (OFDM) communication channel. The PHY data unit includes (i) a first set of one or more short OFDM symbols generated using a normal tone spacing and (ii) a second set of one or more long OFDM symbols generated using a reduced tone spacing, (iii) an OFDM symbol indicator indicative of a number of OFDM symbols in at least one of (a) the first set of OFDM symbols and (b) the second set of OFDM symbols. The network interface is further configured to determine, based at least in part on the OFDM symbol indicator, (i) a number of short OFDM symbols in the set of one or more short OFDM symbols and (ii) a number of long OFDM symbols in the set of one or more long OFDM symbols.

BRIEF DESCRIPTION OF THE DRAWINGS

- [0009]** FIG. 1 is a block diagram of an example wireless local area network (WLAN), according to an embodiment;
- [0010]** FIG. 2 is a diagram of an OFDM data unit, according to an embodiment;
- [0011]** FIG. 3 is a diagram of a legacy signal field, according to an embodiment;
- [0012]** FIGS. 4A-4C are diagrams illustrating OFDM tone spacing used with OFDM symbols of a data unit, according to several embodiments;
- [0013]** FIG. 5 is a diagram illustrating a guard interval used with an OFDM symbol of a data unit, according to an embodiment;
- [0014]** FIG. 6 is a block diagram of a tone spacing and/or guard interval indication field, according to an embodiment;
- [0015]** FIG. 7 is a diagram illustrating bit allocation of a legacy, according to an embodiment;
- [0016]** FIG. 8 is a diagram illustrating bit allocation of a legacy signal, according to another embodiment;
- [0017]** FIG. 9 is a flow diagram of an example method for generating a data unit, according to an embodiment;
- [0018]** FIG. 10 is a flow diagram of an example method for processing a data unit, according to an embodiment.

DETAILED DESCRIPTION

[0019] In embodiments described below, a wireless network device such as an access point (AP) of a wireless local area network (WLAN) transmits data streams to one or more client stations. The AP is configured to operate with client stations according to at least a first communication protocol. The first communication protocol is sometimes referred to herein as “high efficiency Wi-Fi,” “HEW” communication protocol, or 802.11ax communication protocol. In some embodiments, different client stations in the vicinity of the AP are configured to operate according to one or more other communication protocols which define operation in the same frequency band as the HEW communication protocol but with generally lower data throughputs. The lower data throughput communication protocols (e.g., IEEE 802.11a, IEEE 802.11n, and/or IEEE 802.11ac) are collectively referred to herein as “legacy” communication protocols. In at least some embodiments, the legacy communication protocols are generally deployed in indoor communication channels, and the HEW communication protocol is at least sometimes deployed for outdoor communications, extended range communications, or communications in areas with reduced signal-to-noise ratios (SNR) of transmitted signals.

[0020] In an embodiment, an orthogonal frequency division multiplexing (OFDM) data unit that conforms to the HEW communication protocol includes a first set of OFDM symbols generated with a first OFDM tone spacing and a second set of OFDM symbols generated using a second OFDM tone spacing that is smaller than the first OFDM tone spacing. For example, in an embodiment, the first set of OFDM symbols utilizes a “normal” tone spacing defined in the legacy communication protocols, and the second set of OFDM symbols utilizes a “reduced” tone spacing that is a fraction of the normal tone spacing, such as, for example, $\frac{1}{2}$ of the normal tone spacing or $\frac{1}{4}$ of the normal tone spacing, in various embodiments. In an embodiment, a portion of the data unit is decodable by a legacy communication device that is configured according to a legacy communication protocol but not the first communication protocol. The

portion of the data unit that is decodable by a legacy communication device includes a length indication indicative of a duration of the data unit. A legacy device that receives the data unit decodes the duration provided in the decodable portion of the data unit, and refrains from transmitting in the communication medium for the duration of the data unit, thereby protecting transmission of the data unit. In an embodiment, the value for the length indication is computed at the device that transmits the data unit “transmitting device,” based on the first tone spacing used with the first set of OFDM symbols and the second tone spacing, such that a legacy communication device that is receiving the data unit (“receiving device”) can determine at least approximate duration of the data unit. A legacy device that receives the data unit decodes the duration provided in the decodable portion of the data unit, and refrains from transmitting in the communication medium for the duration of the data unit, thereby protecting transmission of the data unit. Additionally, the value of the length indicator in the first portion of the data unit allows a communication device that conforms to the HEW communication protocol to determine the number of OFDM symbols in the data unit, in an embodiment.

[0021] FIG. 1 is a block diagram of an example wireless local area network (WLAN) 10, according to an embodiment. An AP 14 includes a host processor 15 coupled to a network interface 16. The network interface 16 includes a medium access control (MAC) processing unit 18 and a physical layer (PHY) processing unit 20. The PHY processing unit 20 includes a plurality of transceivers 21, and the transceivers 21 are coupled to a plurality of antennas 24. Although three transceivers 21 and three antennas 24 are illustrated in FIG. 1, the AP 14 includes other suitable numbers (e.g., 1, 2, 4, 5, etc.) of transceivers 21 and antennas 24 in other embodiments. In one embodiment, the MAC processing unit 18 and the PHY processing unit 20 are configured to operate according to a first communication protocol (e.g., HEW communication protocol). In another embodiment, the MAC processing unit 18 and the PHY processing unit 20 are also configured to operate according to a second communication protocol (e.g., IEEE 802.11ac Standard). In yet another embodiment, the MAC processing unit 18 and the PHY processing unit 20 are additionally configured to operate according to the second communication protocol, a third communication protocol and/or a fourth communication protocol (e.g., the IEEE 802.11a Standard and/or the IEEE 802.11n Standard).

[0022] The WLAN 10 includes a plurality of client stations 25. Although four client stations 25 are illustrated in FIG. 1, the WLAN 10 includes other suitable numbers (e.g., 1, 2, 3, 5, 6, etc.) of client stations 25 in various scenarios and embodiments. At least one of the client stations 25 (e.g., client station 25-1) is configured to operate at least according to the first communication protocol. In some embodiments, at least one of the client stations 25 is not configured to operate according to the first communication protocol but is configured to operate according to at least one of the second communication protocol, the third communication protocol and/or the fourth communication protocol (referred to herein as a “legacy client station”).

[0023] The client station 25-1 includes a host processor 26 coupled to a network interface 27. The network interface 27 includes a MAC processing unit 28 and a PHY processing unit 29. The PHY processing unit 29 includes a plurality of transceivers 30, and the transceivers 30 are coupled to a

plurality of antennas **34**. Although three transceivers **30** and three antennas **34** are illustrated in FIG. 1, the client station **25-1** includes other suitable numbers (e.g., 1, 2, 4, 5, etc.) of transceivers **30** and antennas **34** in other embodiments.

[0024] According to an embodiment, the client station **25-4** is a legacy client station, i.e., the client station **25-4** is not enabled to receive and fully decode a data unit that is transmitted by the AP **14** or another client station **25** according to the first communication protocol. Similarly, according to an embodiment, the legacy client station **25-4** is not enabled to transmit data units according to the first communication protocol. On the other hand, the legacy client station **25-4** is enabled to receive and fully decode and transmit data units according to the second communication protocol, the third communication protocol and/or the fourth communication protocol.

[0025] In an embodiment, one or both of the client stations **25-2** and **25-3**, has a structure the same as or similar to the client station **25-1**. In an embodiment, the client station **25-4** has a structure similar to the client station **25-1**. In these embodiments, the client stations **25** structured the same as or similar to the client station **25-1** have the same or a different number of transceivers and antennas. For example, the client station **25-2** has only two transceivers and two antennas, according to an embodiment.

[0026] In various embodiments, the PHY processing unit **20** of the AP **14** is configured to generate data units conforming to the first communication protocol and having formats described herein. The transceiver(s) **21** is/are configured to transmit the generated data units via the antenna (s) **24**. Similarly, the transceiver(s) **24** is/are configured to receive the data units via the antenna(s) **24**. The PHY processing unit **20** of the AP **14** is configured to process received data units conforming to the first communication protocol and having formats described hereinafter and to determine that such data units conform to the first communication protocol, according to various embodiments.

[0027] In various embodiments, the PHY processing unit **29** of the client device **25-1** is configured to generate data units conforming to the first communication protocol and having formats described herein. The transceiver(s) **30** is/are configured to transmit the generated data units via the antenna(s) **34**. Similarly, the transceiver(s) **30** is/are configured to receive data units via the antenna(s) **34**. The PHY processing unit **29** of the client device **25-1** is configured to process received data units conforming to the first communication protocol and having formats described hereinafter and to determine that such data units conform to the first communication protocol, according to various embodiments.

[0028] FIG. 2 is a diagram of an OFDM data unit **200** that the AP **14** is configured to transmit to the client station **25-1** via orthogonal frequency domain multiplexing (OFDM) modulation, according to an embodiment. In an embodiment, the client station **25-1** is also configured to transmit the data unit **200** to the AP **14**. The data unit **200** conforms to the HEW communication protocol and occupies a 20 MHz bandwidth. Data units similar to the data unit **200** occupy other suitable bandwidth such as 40 MHz, 80 MHz, 160 MHz, 320 MHz, 640 MHz, for example, or other suitable bandwidths, in other embodiments. The data unit **200** is suitable for “mixed mode” situations, i.e. when the WLAN **10** includes a client station (e.g., the legacy client station **24-4**) that conforms to a legacy communication

protocol, but not the first communication protocol. The data unit **200** is utilized in other situations as well, in some embodiments.

[0029] The data unit **200** includes a preamble **202**, which, in turn, includes a legacy preamble portion **204** and a high efficiency WLAN (HEW) preamble portion **206**. The legacy preamble portion **202** includes an L-STF **208**, an L-LTF **210**, and an L-SIG **212**. The HEW preamble portion **206** includes two first HEW signal fields (HEW-SIGAs) **214** including a first HEW signal field (HEW-SIGA1) **214-1** and a second HEW signal field (HEW-SIGA2) **214-2**, an HEW short training field (HEW-STF) **216**, M HEW long training fields (HEW-LTFs) **218**, where M is an integer, and a third HEW signal field (HEW-SIGB) **220**. Each of the L-STF **208**, the L-LTF **210**, the L-SIG **212**, the HEW-SIGAs **214**, the HEW-STF **216**, the M HEW-LTFs **218**, and the HEW-SIGB **220** comprises an integer number of one or more OFDM symbols. For example, in an embodiment, the HEW-SIGAs **214** comprise two OFDM symbols, where the HEW-SIGA1 **214-1** field comprises the first OFDM symbol and the HEW-SIGA2 **214-2** comprises the second OFDM symbol, in an embodiment. In at least some examples, the HEW-SIGAs **214** are collectively referred to as a single HEW signal field (HEW-SIGA) **214**. The L-SIG **212**, the HEW-SIGAs **214** and the HEW-SIGB **220** generally carry formatting information for the data unit **200**, in an embodiment.

[0030] In some embodiments, the data unit **200** also includes a data portion **222**. In some embodiments, the data portion **222** includes OFDM data symbols **224** and one or more padding OFDM symbols **226**. The OFDM padding symbols **226** correspond to one or more last OFDM symbols of the data portion **222**, in an embodiment. In an embodiment, a padding OFDM symbol includes at least some padding bits added at the end of the data portion **226**. The data unit **200** omits the padding OFDM symbols **226**, or omits the entire data portion **222**, in some embodiments.

[0031] In the embodiment of FIG. 2, the data unit **200** includes one of each of the L-STF **208**, the L-LTF **210**, the L-SIG **212**, and the HEW-SIGA1 s **214**. In other embodiments in which an OFDM data unit similar to the data unit **200** occupies a cumulative bandwidth other than 20 MHz, each of the L-STF **208**, the L-LTF **210**, the L-SIG **212**, the HEW-SIGA1 s **214** is repeated over a corresponding number of 20 MHz sub-bands of the whole bandwidth of the data unit, in an embodiment. For example, in an embodiment, the OFDM data unit occupies an 80 MHz bandwidth and, accordingly, includes four of each of the L-STF **208**, the L-LTF **210**, the L-SIG **212**, the HEW-SIGA1 s **214**, in an embodiment. In some embodiments, the modulation of different 20 MHz sub-bands signals is rotated by different angles. For example, in one embodiment, a first subband is rotated 0-degrees, a second subband is rotated 90-degrees, a third sub-band is rotated 180-degrees, and a fourth sub-band is rotated 270-degrees. In other embodiments, different suitable rotations are utilized. The different phases of the 20 MHz sub-band signals result in reduced peak to average power ratio (PAPR) of OFDM symbols in the data unit **200**, in at least some embodiments. In an embodiment, if the data unit that conforms to the first communication protocol is an OFDM data unit that occupies a cumulative bandwidth such as 20 MHz, 40 MHz, 80 MHz, 160 MHz, 320 MHz, 640 MHz, etc., the HEW-STF, the HEW-LTFs, the HEW-SIGB and the HEW data portion occupy the corresponding whole bandwidth of the data unit.

[0032] In an embodiment, the legacy preamble portion 204 of the preamble 202 is decodable by legacy communication devices that conform to a legacy communication protocol, but do not conform to the first communication protocol. In an embodiment, a client station that conforms to a legacy communication protocol will recognize the legacy preamble portion 204 of the preamble 202 and will set the data unit duration according to a duration indicated in the L-SIG field 212 of the legacy preamble portion 204. For example, the legacy client station will calculate a duration based on a rate and a length (e.g., in number of bytes) indicated in the L-SIG field 212, according to an embodiment. In an embodiment, the rate and the length in the L-SIG field 212 are set such that a client station configured to operate according to a legacy communication protocol will calculate, based on the rate and the length, a packet duration (T) that corresponds to, or at least approximates, the actual duration of the data unit 200. For example, the rate is set to indicate a lowest rate defined by the IEEE 802.11a Standard (i.e., 6 Mbps), and the length is set to a value computed such that packet duration computed using the lowest rate at least approximates the actual duration of the data unit 200, in one embodiment.

[0033] In an embodiment, a legacy client station that conforms to the IEEE-802.11a Standard, when receiving the data unit 200, will compute a packet duration for the data unit 200, e.g., using a rate and a length fields of L-SIG field 212, and will wait until the end of the computed packet duration before performing clear channel assessment (CCA), in an embodiment. Thus, in this embodiment, communication medium is protected against access by the legacy client station at least for the duration of the data unit 200. In an embodiment, the legacy client station will continue decoding the data unit 200, but will fail an error check (e.g., using a frame check sequence (FCS)) at the end of the data unit 200.

[0034] FIG. 3 is a diagram of a legacy signal field L-SIG 300, according to an embodiment. In an embodiment, the L-SIG field 300 is included in the data unit 200 of FIG. 2. For example, the L-SIG field 300 corresponds to the L-SIG field 212 of the data unit 200 of FIG. 2. In another embodiment, the L-SIG field 300 is included in a data unit different from the data unit 200 of FIG. 2. Similarly, the data unit 200 of FIG. 2 includes a legacy signal field different from the L-SIG field 300, in an embodiment. Merely for ease of explanation, the signal field L-SIG 300 is described below as being used as the signal field L-SIG 212 of the data unit 200 of FIG. 2.

[0035] The L-SIG field 300 includes a plurality of subfield 302. In particular, the L-SIG field 300 includes a rate subfield 302-1, a reserved subfield 302-2, a length sub-field 302-3, a parity sub-field 302-4, and tail bits 306-5. In an embodiment, the rate sub-field 302-1 comprises 5 bits, the reserved sub-field 302-2 comprises a single reserved bit, the length sub-field 302-3 comprises 12 bits, the parity sub-field 302-4 includes a single parity bit, and the tail bits 302-5 comprise six tail bits. In an embodiment, the rate sub-field is set to indicate a rate of 6 Mbps to a legacy communication device that conforms to a legacy communication protocol but does not conform to the HEW communication protocol. The length sub-field 302-3 is set based on the actual length of the data 200, such that the legacy device can determine, using the rate of 6 Mbps as indicated by the rate sub-field

302-1, a packet duration that at least approximates the actual duration of the data unit 200.

[0036] FIGS. 4A-4C are diagrams illustrating OFDM tone spacing used with OFDM symbols of a data unit, such as the data unit 200 of FIG. 2, in some embodiments. Turning first to FIG. 4A, the tone spacing 400 corresponds to tone spacing defined in a legacy communication protocol (e.g., the IEEE 802.11n Standard or the IEEE 802.11ac Standard). For example, tone spacing 400 corresponds to the tone spacing defined in the IEEE 802.11a Standard, in an embodiment. In this embodiment, an OFDM symbol generated with the tone spacing 400 for a 20 MHz bandwidth is generated using a 64 point IFFT, resulting in the tone spacing (TS) of 312.5 kHz. Turning now to FIG. 4B, a tone spacing 420 is reduced by a factor of 2 ($\frac{1}{2}$) with respect to the tone spacing 400 of FIG. 4A. For example, continuing with the example above, whereas on OFDM symbol generated with the tone spacing 400 for a 20 MHz bandwidth is generated using a 64 point IFFT, an OFDM symbol generated with the tone spacing 420 for a 20 MHz bandwidth is generated using a 128 point IFFT, resulting in the $\frac{1}{2}$ of the tone spacing 400 of FIG. 4A (i.e., 156.25 kHz). Similarly, turning now to FIG. 4C, a tone spacing 450 is reduced by a factor of 4 ($\frac{1}{4}$) with respect to the tone spacing 400 of FIG. 4A. For example, continuing again with the example above, whereas on OFDM symbol generated with the tone spacing 400 for a 20 MHz bandwidth is generated using a 64 point IFFT, an OFDM symbol generated with the tone spacing 450 for a 20 MHz bandwidth is generated using a 256 point IFFT, resulting in the $\frac{1}{4}$ of the tone spacing 400 of FIG. 4A (i.e., 78.125 kHz). A tone spacing defined in a legacy communication protocol, such as the tone spacing 400 of FIG. 4A, is sometimes referred to herein as “normal tone spacing” and a tone spacing that is smaller than the tone spacing defined by the legacy communication protocol, such as the tone spacing 420 of FIG. 4B and the tone spacing 450 of FIG. 4C is sometimes referred to herein as “reduced tone spacing.”

[0037] In an embodiment, a first set of OFDM symbols of the data unit 200 of FIG. 2 is generated with the tone spacing 400 of FIG. 4A. For example, at least OFDM symbols of the legacy preamble portion 204 are generated using the tone spacing 400 of FIG. 4A, in an embodiment. In an embodiment, one or more OFDM symbols of the HEW preamble portion 206 of the data unit 200 and/or one or more OFDM symbols of the HEW data portion 222 of the data unit 200, in addition to the OFDM symbols of the legacy preamble portion 204 of the data unit 200 are generated using the tone spacing 400 of FIG. 4A. Further, in an embodiment, a second set of OFDM symbols of the data unit 200 are generated using the tone spacing 420 of FIG. 4B or the tone spacing 450 of FIG. 4C, in an embodiment. For example, a particular tone spacing is selected for the second set of OFDM symbols based on factors such as characteristics of the communication channel in which the data unit 200 is to be transmitted, mode of deployment of the data unit 200, etc., as discussed above, in an embodiment. In another embodiment, only a single tone spacing is supported for the second set of OFDM symbols. For example, only the $\frac{1}{4}$ tone spacing 450 of FIG. 4C is supported, in an embodiment. In one such embodiment, tone spacing selection for the second set of OFDM symbols of the data unit 200 does not occur, but rather the $\frac{1}{4}$ tone spacing is always used for the second set of OFDM symbols. Alternatively, in another embodiment, either the tone spacing 400 of FIG. 4A or the tone

spacing **450** of FIG. **4C** is selected for the second set of OFDM symbols. Generally speaking, an OFDM symbol generated with a relatively smaller tone spacing is longer, in time duration, relative to an OFDM symbol generated with a relatively larger tone spacing. Thus, for example, an OFDM symbols generated with the tone spacing **450** of FIG. **4C** is longer, in time duration, than an OFDM symbol generated with the tone spacing **420** of FIG. **4B**, in an embodiment. Similarly, an OFDM symbols generated with the tone spacing **420** of FIG. **4B** is longer, in time duration, than an OFDM symbol generated with the tone spacing **400** of FIG. **4A**, in an embodiment.

[0038] FIG. **5** is a diagram illustrating a guard interval used with an OFDM symbol of a data unit, such as the data unit **200** of FIG. **2**, according to an embodiment. In an embodiment, a guard interval portion **502** is pre-pended to an information portion of the OFDM symbol **504**. In an embodiment, the guard interval comprises a cyclic prefix repeating an end portion of the information portion **504**. In an embodiment, the guard interval portion **502** is used to ensure orthogonality of OFDM tones at a receiving device (e.g., the client station **25-1**) and to minimize or eliminate inter-symbol interference due to multi-path propagation in the communication channel via which the OFDM symbol is transmitted. In an embodiment, the length of the guard interval portion **502** is selected based on expected worst case channel delay spread in the communication channel between the transmitting device and the receiving device. For example, a longer guard interval is selected for outdoor communication channels typically characterized by longer channel delay spreads as compared to a shorter guard interval selected for indoor communication channels typically characterized by shorter channel delay spreads, in an embodiment.

[0039] According to an embodiment, the length of the guard interval portion **502** to be used with particular OFDM symbols of the data unit **200** is selected from a set of guard intervals supported by the HEW communication protocol. For example, the set of guard intervals supported by the HEW communication protocol includes $0.4 \mu\text{s}$, $0.8 \mu\text{s}$, $1.6 \mu\text{s}$, and $3.2 \mu\text{s}$ guard intervals. In other embodiment, the set of guard intervals supported by the HEW communication protocol exclude one or more of $0.4 \mu\text{s}$, $0.8 \mu\text{s}$, $1.6 \mu\text{s}$, and $3.2 \mu\text{s}$ and/or include one or more suitable guard intervals other than $0.4 \mu\text{s}$, $0.8 \mu\text{s}$, $1.6 \mu\text{s}$, and $3.2 \mu\text{s}$ instead of or in addition to the guard intervals $0.4 \mu\text{s}$, $0.8 \mu\text{s}$, $1.6 \mu\text{s}$, and $3.2 \mu\text{s}$. In an embodiment, in accordance with terminology used in a legacy communication protocol (e.g., the IEEE 802-11n Standard or the IEEE 802-11 ac Standard), a guard interval of $0.8 \mu\text{s}$ is sometimes referred to herein as a “normal guard interval” and a guard interval of $0.4 \mu\text{s}$ is sometimes referred to herein as “short guard interval.”

[0040] In an embodiment, a particular tone spacing and/or a particular guard interval is selected for at least some OFDM symbols of the data unit **200** depending on one or more factors such as the mode of deployment of the data unit **200** (e.g., whether the data unit **200** is to be transmitted indoors or outdoors, whether the data unit **200** is communicated between non-moving devices or devices moving with relatively slow speeds, etc.), characteristics and/or channel conditions of the communication channel in which the data unit **200** is to be transmitted, etc. For example, in an embodiment, a shorter guard interval and/or a larger tone spacing is selected for at least some OFDM symbols of the

data unit **200** when the data unit **200** is to be transmitted in a communication channel characterized by shorter channel delay spreads (e.g., indoor communication channels), while a longer guard interval and/or a smaller tone spacing is selected for at least some OFDM symbols of the data unit **200** when the data unit **200** characterized by relatively longer channel delay spreads (e.g., outdoor communication channels).

[0041] In at least some embodiments and/or scenarios, OFDM symbols of a first set of one or more OFDM symbols of the data unit **200** are generated using a first tone spacing and/or a first guard interval, and OFDM symbols of a second set of one or more OFDM symbols are generated using a second tone spacing and/or a second guard interval. For example, OFDM symbols of the legacy portion **204** of the preamble **202** are generated using the normal spacing and a legacy guard interval (e.g., the normal guard interval), while the HEW preamble portion **206** and the data portion **222** are generated using a tone spacing different from the legacy guard interval and/or a guard interval different from the legacy guard interval, in an embodiment. In another embodiment, one or more OFDM symbols of the HEW preamble portion **206** and the data portion **222** are generated using the legacy tone spacing in addition of the OFDM symbols of the legacy preamble portion **204**. For example OFDM symbols of one or more of the HEW-SIGA field **214**, the HEW-LTF (s) **218** and the padding OFDM symbols **226** of the data field **222** are generated using the normal tone spacing, while OFDM symbols of the HEW-STF field **216**, the HEW-SIGB **220** and the data portion **222** are generated using a tone spacing different from the legacy guard interval and/or a guard interval different from the normal guard interval, in an embodiment.

[0042] In an embodiment, the actual duration of the data unit **200** depends on the duration of each OFDM symbol included in the data unit **200**. The duration of each OFDM symbol is determined by the tone spacing and the guard interval used to generate the OFDM symbol, in embodiments. Consequently, the value of the length subfield in the L-SIG field **212** of the data unit **200** is a function of the tone spacing options and the guard intervals selected for the OFDM symbols of the data unit **200**, in an embodiment. In an embodiment, the value of the length field **302-3** is determined according to

$$L_LENGTH = \left\lceil \frac{TXTIME - 20}{4} \right\rceil \times 3 - 3 \quad \text{Equation 1}$$

where TXTIME is the actual transmission time of the data unit, and r denotes an integer ceiling operation. In an embodiment, TXTIME for the data unit is a function of a number of OFDM symbols in the data unit, and duration of each of the OFDM symbols in the data unit. Accordingly, in an embodiment and/or scenario in which the data unit **200** includes OFDM symbols with different tone spacing options, TXTIME is calculated using different symbol durations corresponding to the different tone spacing options. In an embodiment, OFDM symbol duration is calculated according to

$$T_{HEW} = \frac{3.2\mu s}{r_{TS}} + GI \quad \text{Equation 2}$$

wherein r_{TS} is the tone spacing factor with respect to the normal tone spacing, such as tone spacing of 312.5 kHz, for example, and GI is the length of the guard interval being used for the particular OFDM symbol. Further, in an embodiment, TXTIME in Equation 2 is determined using OFDM symbol duration, given in Equation 2, according to

$$TXTIME = T_{L_PREMABLE} + T_{L_SIG} + T_{HEW_PREMABLE} + T_{HEW_SIG} + T_{HEW} \times N_{SYM} + T_{HEW_PADDING} \quad \text{Equation 3}$$

[0043] Referring FIG. 2 and Equation 3, $T_{L_PREMABLE}$ is the duration of the legacy training fields of the legacy portion 204 of the preamble 202, in an embodiment. Accordingly, $T_{L_PREMABLE}$ includes the duration of the L-STF field 208, the duration of the L-LTF field 210, in an embodiment. T_{L_SIG} is a duration of the legacy signal field L-SIG 212 of the legacy preamble portion 204 of the preamble 202, in an embodiment. In an embodiment in which OFDM symbols of the legacy training fields of the legacy preamble portion 204 are generated using the legacy tone spacing of 312.5 kHz and guard interval of 0.8 μs , $T_{L_PREMABLE} + T_{L_SIG} = 20 \mu s$. In other embodiments, one or more OFDM symbols of the legacy preamble portion 204 are generated using tone spacing other than 312.5 kHz and/or using guard interval other than 0.8 μs , resulting in $T_{L_PREMABLE} + T_{L_SIG}$ duration other than 20 μs .

[0044] With continued reference to FIG. 2 and Equation 3, $T_{HEW_PREMABLE}$ includes the duration of the signal field A HEW-SIGA 214 and the duration of training fields HEW-STF 216 and HEW-LTFs 218, in an embodiment. Further, T_{L_SIG} corresponds to the duration of the legacy signal field L-SIG 212, T_{HEW_SIG} corresponds to the duration of the HEW-SIGB field 220, $T_{HEW} \times N_{SYM}$ corresponds to the duration of the HEW data portion 222, and $T_{HEW_PADDING}$ corresponds to the duration of the padding OFDM symbols 226, in an embodiment. In an embodiment, the particular values of $T_{HEW_PREMABLE}$, T_{HEW_SIG} , $T_{HEW} \times N_{SYM}$, and $T_{HEW_PADDING}$ are determined based on the tone spacing and the guard interval used with the corresponding OFDM symbols of the data unit 200.

[0045] In an embodiment, the data unit 200 includes tone spacing and/or guard interval (TSGI) indication to indicate the tone spacing and the guard interval used for the second set of OFDM symbols, in an embodiment. The TSGI indication allows a receiving device that conforms to the HEW communication protocol to determine the number of OFDM symbols in the data unit 200 based on the value of the length subfield in the L-SIG field 212 of the data unit 200, in an embodiment. FIG. 6 is a block diagram of a TSGI indication field 600, according to an embodiment. In an embodiment, the TSGI indication field 600 is included in the HEW-SIGA field 214 of the data unit 200. The TSGI indication field 600 includes a tone spacing indication sub-field 602-1 and a guard interval subfield 602-2 and, accordingly, is capable of indicating a maximum of four tone spacing and guard interval options, respectively, in an embodiment. In an embodiment, each of the tone spacing indication sub-field 602-1 and the guard interval subfield 602-2 comprises two bits. As just an example, a value of 00 of the tone spacing sub-field 602-1 indicates that the normal tone spacing (e.g., the tone spacing 400 of FIG. 4A) is used for the second set

of OFDM symbols, a value of 01 of the tone spacing sub-field 602-1 indicates that a tone spacing that is $\frac{1}{2}$ of the normal tone spacing (e.g., the tone spacing 420 of FIG. 4B) is used for the second set of OFDM symbols, a value of 10 of the tone spacing sub-field 602-1 indicates that a tone spacing that is $\frac{1}{4}$ of the normal tone spacing (e.g., the tone spacing 450 of FIG. 4C) is used for the second set of OFDM symbols, and the value of 11 of the tone spacing sub-field 602-1 is not used, or reserved. In an embodiment, a value of 00 of the guard interval sub-field 602-2 indicates that the guard interval of 0.4 μs is used for the second set of OFDM symbols, a value of 01 of the guard interval sub-field 602-2 indicates that the guard interval of 0.8 μs is used for the second set of OFDM symbols, a value of 10 of the guard interval sub-field 602-2 indicates that the guard interval of 1.6 μs is used for the second set of OFDM symbols, and the value of 11 of the tone spacing sub-field 602-1 indicates that the guard interval of 3.2 μs is used for the second set of OFDM symbols, in an embodiment. The TSGI indication field also includes a single bit GI ambiguity sub-field 602-3, in an embodiment. The GI ambiguity sub-field 602-3 is used to disambiguate a calculation of the number of OFDM symbols in a data unit when the number of OFDM symbols is calculated at a receiving device based on a value of a legacy length sub-field (e.g., the length sub-field 302-3) when the value of the legacy sub-field is calculated according to Equation 1. For example, in an embodiment, to disambiguate a calculation of the number of OFDM symbols in a data unit when the number of OFDM symbols is calculated at a receiving device based on a value of a legacy length sub-field, the GI ambiguity sub-field 602-3 is set to 0 if the number of OFDM symbols N_{SYM} in the data unit satisfies the condition that $N_{SYM} \% 10 \neq 9$, and is set to 1 if the number of OFDM symbols N_{SYM} in the data unit satisfies the condition that $N_{SYM} \% 10 = 9$, in an embodiment.

[0046] In an embodiment, a communication device that conforms to the HEW communication protocol, when receiving the data unit 200, determines a number of OFDM symbols in the data unit 200 based on the value of the length indication in L-SIG field 212 of the data unit 200, and using a TSGI indication in the HEW-SIGA field 214 of the data unit 200. For example, in an embodiment, when the length indication in L-SIG field 212 is determined at the transmitting device according to Equation 1, the receiving device determines the number of OFDM symbols according to

$$N_{SYM} = \left\lfloor \left(\frac{L - \text{LENGTH} + 3}{3} \times 4 - T_{HEW_PREMABLE} - T_{HEW_SIG} \right) / T_{HEW} - 1 \right\rfloor \quad \text{Equation 4}$$

or according to

$$N_{SYM} = \left\lfloor \left(\frac{L - \text{LENGTH} + 3}{3} \times 4 - T_{HEW_PREMABLE} - T_{HEW_SIG} \right) / T_{HEW} \right\rfloor \quad \text{Equation 5}$$

In particular, in an embodiment, the receiving device utilizes Equation 4 to determine the number of symbols N_{SYM} when the TSGI indication indicates that the normal tone spacing and the guard interval of $0.4 \mu s$ is used for the second set of OFDM symbols and the GI ambiguity bit of the TSGI indication is set to 0 (e.g., when the TSGI indication is set to the value 0000), or utilizes Equation 5 in other situations (e.g., when the TSGI indication is set to any value other than 0000). In either case, the receiving device determines the values of $T_{HEW_PREMABLE}$, T_{HEW_SIGB} and T_{HEW} in Equations 4 and 5 based on the particular tone spacing and the particular guard interval indicated by the corresponding bits of the TSGI indication in the data unit, in an embodiment.

[0047] In another embodiment, instead of using Equation 1 to determine the value of the length indication in L-SIG field 212, the transmitting device determines the value of the length indication in L-SIG field 212 according to

$$L_LENGTH = \left\lceil \frac{TXTIME - 20}{4} \times 3 \right\rceil - 3 \quad \text{Equation 6}$$

where TXTIME is the actual duration of the data unit 200, determined as described above with respect to Equation 1. As can be seen from a comparison of Equations 1 and 6, a rate conversion factor of 3 is applied to a time duration

$$\left(\frac{TXTIME - 20}{4} \right)$$

before the ceiling operation is applied to the time duration in Equation 6 as compared to applying the conversion factor of 3 to the time duration after application of the ceiling operation in Equation 1. In this case, ambiguity of the number of OFDM symbols when the number of OFDM symbols is calculated at the receiving device does not arise, in an embodiment. Accordingly, a GI ambiguity indication is not needed, and is omitted from the TSGI indication, in an embodiment. For example, the GI ambiguity sub-field 602-3 is omitted from the TSGI indication field 600, in an embodiment. In an embodiment in which the GI ambiguity sub-field 602-3 is omitted from the TSGI indication field 600, the TSGI indication field 600 comprises only four bits as compared to the 5-bit TSGI indication field 600 described above. Further, in this embodiment, only a single equation is needed to calculate the number of OFDM symbols based on the value of the length indication in the L-SIG field 212 at the receiving device. In particular, the receiving device determines the number of OFDM according to Equation 4, in an embodiment.

[0048] As discussed above, in an embodiment, the HEW communication protocol supports only a single reduced tone spacing, in addition to the normal tone spacing. For example, the HEW communication protocol supports only a $\frac{1}{4}$ tone spacing in addition to the normal tone spacing. In one such embodiment, a transmitting device determines the value of the length indicator, based on the reduced tone spacing used with at least some OFDM symbols of the data unit 200, according to Equation 1. In another such embodiment, a transmitting device determines the value of the length indicator, based on the reduced tone spacing used with at least some OFDM symbols of the data unit 200,

according to Equation 6. In either case, in such embodiments, the transmitting devices determines the duration of HEW fields of the data unit according to

$$\begin{aligned} T_{HEW_FIELDS} &= T_{HEW_PREMABLE} + T_{HEW_SYM} \times \\ N_{SYM} &= T_{HEW_PREMABLE} + \\ & (12.8 + GI) \times N_{HEW_SYM} \end{aligned} \quad \text{Equation 7}$$

In this embodiment, because only a single reduced tone spacing is supported by the HEW communication protocol, a tone spacing indication is not needed. In this case, referring to FIG. 6, the TS subfield 602-1 is not needed, and is omitted from the TSGI indication field 600, in an embodiment. Further, ambiguity of the number of OFDM symbols when the number of OFDM symbols is calculated at the receiving device does not arise, in this embodiment. Accordingly, a GI ambiguity indication is also not needed, and the GI ambiguity sub-field 602-3 is omitted from the TSGI indication field 600, in this embodiment.

[0049] Further, in this embodiment, only a single equation is needed to calculate the number of OFDM symbols based on the value of the length indication in the L-SIG field 212 at the receiving device. In particular, in an embodiment, the receiving device determines the number of OFDM according to

$$N_{SYM} = \left\lceil \left(\frac{L - LENGTH + 3}{3} \times 4 - T_{HEW_PREMABLE} \right) / (12.8 + GI) \right\rceil \quad \text{Equation 8}$$

[0050] In another embodiment, some OFDM symbols of the HEW portion of the data unit 200 are “short OFDM symbols” generated using a relatively larger tone spacing (e.g., the normal tone spacing), while other OFDM symbols of the data unit 200 are “long OFDM symbols” generated using a relatively smaller tone spacing (e.g., a reduced tone spacing, such as a $\frac{1}{4}$ tone spacing). In an embodiment, the HEW communication protocol supports only a single reduced tone spacing (e.g., $\frac{1}{4}$ tone spacing), and the long OFDM symbols are generated using the single supported tone spacing. In at least some such embodiments, a first guard interval “ GI_{short} ” is used for the short OFDM symbols, and a second guard interval “ GI_{long} ” is used for the long OFDM symbols. In an embodiment, and HEW-SIG field, such as the HEW-SIGA field 214, includes an indication of the value of the guard interval GI used for the short OFDM symbols and an indication of the value of the guard interval GI_{long} used for the long OFDM symbols. In an embodiment in which only a single reduced tone spacing is supported for use with the long OFDM symbols, a tone spacing indication is not needed. Accordingly, referring to FIG. 6, the TS subfield 602-1 is omitted from the indication field 600, in an embodiment. On the other hand, the GI subfield 602-2 is expanded to include indications of the value of the guard interval GI_{short} used with the short OFDM symbols and an indication of the value of the guard interval GI_{long} used with the long OFDM symbols, in an embodiment. In an embodiment, the GI subfield 602-2 is further expanded to include indications of the number of short OFDM symbols and/or the number of long OFDM symbols, as described in more detail below, in various embodiments. [0051] In an embodiment, the GI subfield 602-2 includes indications of indications of the value of the guard interval GI_{short} used for the short HEW OFDM symbols and an indication of the value of the guard interval GI_{long} used for

the long HEW OFDM symbols in the data unit **200**, and additionally includes an indication of the number of short HEW OFDM symbols N_{SYM_Short} in the data unit **200**. In this embodiment, a receiving device calculates a number of long HEW OFDM symbols N_{SYM_Long} in the data unit **200**. In an embodiment, the receiving device calculates the number of long HEW OFDM symbols N_{SYM_Long} according to

$$N_{SYM_Long} = \left\lfloor \left(\frac{L - \text{LENGTH} + 3}{3} \times 4 - T_{HEW_PREAMBLE} - (3.2 + G_{I_{short}}) \times N_{SYM_Short} \right) / (12.8 + GI) \right\rfloor \quad \text{Equation 9}$$

[0052] In this embodiment, ambiguity of the number of OFDM symbols when the number of OFDM symbols is calculated at the receiving device does not arise, in this embodiment. Accordingly, a GI ambiguity indication is not needed, in this embodiment. Referring to FIG. 6, the GI ambiguity subfield **602-2** is omitted from the indication field **602-3**, in this embodiment.

[0053] In another embodiment in which short HEW OFDM symbols and long HEW OFDM symbols are used in the data unit **200**, instead of signaling the number of short HEW OFDM symbols or the number of long HEW OFDM symbols in the data unit **200**, respective ambiguity indications are included in the data unit **200** to indicate when ambiguity conditions are met when the number of short HEW OFDM symbols and the number of long HEW OFDM symbols are calculated at the receiving device that receives the data unit **200**. For example, referring to FIG. 6, the GI ambiguity subfield **602-3** of the GI indication field **600** is expanded to include a first ambiguity bit Ambiguity_{Long} indicative of ambiguity in calculating the number of short HEW OFDM symbols N_{SYM_Long} , and a second ambiguity bit Ambiguity_{Short} indicative of ambiguity in calculating the number of short HEW OFDM symbols N_{SYM_Short} . In an embodiment, the transmitting device sets the Ambiguity_{Long} bit to logic one (1) when a stored condition for long HEW OFDM symbol ambiguity is met for the data unit **200**. Similarly, the transmitting device sets the Ambiguity_{Short} bit to logic one (1) when a stored condition for short HEW OFDM symbol ambiguity is met for the data unit **200**, in an embodiment. The stored conditions for long HEW OFDM symbol ambiguity and short HEW OFDM symbol ambiguity are based on various factors, such as one or more of (i) the particular values of GI_{short} and GI_{long} being utilized for the data unit **200**, (ii) the number of HEW OFDM symbols in the data unit **200**, (iii) the number of long HEW OFDM symbols in the data unit **200**, (iv) the number of HEW OFDM symbols in the data unit **200**, etc., in an embodiment.

[0054] In this embodiment, a receiving device that receives the data unit **200** calculates a number of long HEW OFDM symbols N_{SYM_Long} in the data unit **200** and a number of short HEW OFDM symbols N_{SYM_Short} in the data unit **200** based on the indications included in the data unit **200**. In an embodiment, the receiving device calculates the number of long HEW OFDM symbols N_{SYM_Long} according to

$$N_{SYM_Long} = \left\lfloor \left(\frac{L - \text{LENGTH} + 3}{3} \times 4 - T_{HEW_PREAMBLE} \right) / (12.8 + GI) \right\rfloor \quad \text{Equation 10}$$

-continued

$$(12.8 + GI_{Long}) \left\rfloor - \text{Ambiguity}_{Long}$$

and then calculates the number of long HEW OFDM symbols N_{SYM_Long} according to

$$N_{SYM_Short} = \left\lfloor \left(\frac{L - \text{LENGTH} + 3}{3} \times 4 - T_{HEW_PREAMBLE} - N_{SYM_Long} \times (12.8 + GI_{Long}) \right) / (3.2 + GI_{Short}) \right\rfloor - \text{Ambiguity}_{Short} \quad \text{Equation 11}$$

[0055] In some embodiments described above, the value of the L_LENGTH indication included in the L_SIG field **212** of the data unit **200** is constrained to be a multiple of 3. For example, in embodiments in which the factor of 3 in the L_LENGTH indication value computation is applied to the time duration after the ceiling operator is applied to the time duration, such as when the value of the L_LENGTH indication is computed according to Equation 1, the value of L_LENGTH indication is constrained to be a multiple of 3 by virtue of applying the factor of 3 to an integer result of the ceiling operation. In some such embodiments, a non-legacy communication device receiving the data unit **200** assumes that the data unit **200** is a non-legacy data unit when the L_LENGTH indication value in the data unit is determined to be divisible by 3.

[0056] In some embodiments, the value of the L_LENGTH indication is constrained to be a multiple of a suitable integer other than 3 to allow a communication device that conforms to the HEW communication protocol to detect, based on the value of the L_LENGTH indication in the L_SIG field **212**, that the data unit **200** conforms to the HEW communication protocol. For example, in some embodiments, the value of the L_LENGTH indication in the L_SIG field **212** is calculated according to

$$L_LENGTH = \left\lceil \frac{TXTIME - 20}{4} \right\rceil \times 3 - 3 + n \quad \text{Equation 12}$$

where n is a suitable integer, such as $n=1$ or $n=2$, in embodiments. In an embodiment, a communication device that is configured according to the HEW communication protocol checks whether the value of the L_LENGTH subfield in the L_SIG field **212** is a multiple of 3 (e.g., $\text{mod}(L_LENGTH, 3)=0$). In an embodiment, if it is determined that the value of the L_LENGTH subfield in the L_SIG field **212** is not a multiple of 3, then the communication device decides that the data unit does not conform to the HT/VHT communication protocol. If the communication device determines that the data unit does not conform to the HT/VHT communication protocol, the communication device then determines whether the data unit conforms to a legacy communication protocol (e.g., the IEEE 802.11a Standard) or conforms to the HEW communication protocol based on an indication included in the HEW preamble portion of the data unit, in an embodiment.

[0057] In an embodiment in which the value of the L_LENGTH indication in the L_SIG field 212 is determined according to Equation 12, a receiving device that receives the data unit 200 calculates the number of OFDM symbols in the data unit 200 according to

$$N_{SYM} = \left\lceil \left(\frac{L_LENGTH + 3 - n}{3} \times 4 \right) / T_{HEW} \right\rceil \quad \text{Equation 13}$$

where n=1 or n=2, as described above.

[0058] FIG. 7 is a diagram illustrating bit allocation of a legacy signal L_SIG field 700, such as the L_SIG field 212 of the data unit 200 of FIG. 2, according to an embodiment. In the embodiment of FIG. 7, the L_SIG field 700 includes a rate sub-field 702, a reserved sub-field 704, a length sub-field 706, a parity subfield 708 and tail bits 710. The rate in the rate subfield 702 and the length in the length subfield 706 are set as described above such that a legacy device can at least approximately determine a duration of the remainder of the data unit 200 after the legacy preamble portion 204, in various embodiments. In the embodiment illustrated in FIG. 7 the length subfield 706 comprises 12 bits. In an embodiment, the twelve bits of the length subfield 706 can represent a maximum packet length of 4,096 bytes.

[0059] In some embodiments, the value of a length indication in a legacy signal field of a data unit is constrained to occupy one or more fewer bits compared to the number of bits allocated to length indication in the legacy communication protocol. In some such embodiment, the one or more bits that are not used for indicating length according to the HEW communication protocol are used for another purpose defined by the HEW communication protocol. For example, the one or more bits that are not used for indicating length according to the HEW communication protocol are used as additional error check bits to improve reliability of the legacy signal field, according to some embodiments. FIG. 8 is a diagram illustrating bit allocation of a legacy signal L_SIG field 800, such as the L_SIG field 212 of the data unit 200 of FIG. 2, according to an embodiment. Bit allocation of the L_SIG field 800 is similar to the bit allocation of the L_SIG field 700 illustrated in FIG. 7, except that in the L_SIG field 800, only ten bits of a 12-bit length subfield 806 are designated for indicating a length of the data unit, as compared to the entire twelve bits being designated for indicating a length of the data unit. In an embodiment, the remaining two bits (e.g., bit 5 and bit 6) of the length subfield 806 are used for a suitable purpose other than indicating a length of the data unit. For example, at least one of the remaining bits is used as an additional parity bit, in addition to the parity bit in the parity subfield 708, to improve reliability of the L_SIG field 800. In another embodiment, at least one of the bits of the length subfield 806 that are not designated for indicating length is used to signal to communication devices that conform to the HEW communication protocol that the data unit 200 conforms to the HEW communication protocol, to signal a particular HEW mode of the data unit 200, etc.

[0060] In an embodiment, to calculate the value of the length subfield 806, a transmitting device first calculates L_LENGTH value according to

$$L_LENGTH = \left\lfloor \frac{TXTIME - 20}{4} \right\rfloor \times 3 - 3 \quad \text{Equation 14}$$

as described above. Then, the transmitting device calculates a new L_LENGTH value based on the L_LENGTH value computed according to Equation 14. In an embodiment, the new L_LENGTH is determined according to

$$L_LENGTH = \left\lfloor \frac{L_LENGTH}{2^m} \right\rfloor \times 2^m \quad \text{Equation 15}$$

[0061] where m is an integer corresponding to the number of bits of the length subfield 806 that are not designated for indicating length, in an embodiment. For example m=1 in an embodiment in which 11 of the 12 length subfield bits are designated for indicating length, example m=2 in an embodiment in which 10 of the 12 length subfield bits are designated for indicating length, example m=3 in an embodiment in which 9 of the 12 length subfield bits are designated for indicating length, etc., in various embodiments. In at least some such embodiments (e.g., where m=1, m=2, or m=3), ambiguity of the number of OFDM symbols when the number of OFDM symbols is calculated at the receiving device does not arise, and no guard interval ambiguity bits are needed in the HEW portion 206 are needed.

[0062] In an embodiment, to calculate the number of OFDM symbols at the receiving devices, the (12-m) bits of the length subfield 806 that are designated for indicated length are extracted from the length subfield 806, and the extracted bits are padded with m zero bits to replace the bits of the length subfield 806 that are not designated for indicating length (e.g., the m least significant bits). Then, the number of HE OFDM symbols is calculated using the padded L_LENGTH bits, in an embodiment. More specifically, in an embodiment, the number of HE OFDM symbols is calculated according to

$$N_{SYM} = \left\lceil \left(\frac{L_LENGTH + 3}{3} \times 4 \right) / T_{HEW} \right\rceil \quad \text{Equation 16}$$

[0063] In a more specific example, in an embodiment in which m=2, and, accordingly, two bits of the twelve bit length subfield 806 are designated to be used for a purpose other than indicating length, a length value L_LENGTH is first computed according to Equation 16, and a new length value L_LENGTH is then determined according to

$$L_LENGTH = \left\lfloor \frac{L_LENGTH}{2^2} \right\rfloor \times 2^2 \quad \text{Equation 17}$$

As can be seen for Equation 17, in this case, the value of the length subfield 806 is constrained to be a multiple of four. Further, in an embodiment, if the value L_LENGTH satisfies $\text{mod}(L_LENGTH, 6) = 0$, then the value of L_LENGTH is incremented by four (i.e., L_LENGTH+=4), in an embodiment.

[0064] Continuing with the example embodiment in which $m=2$, the two unused bits (e.g., the two least significant bits) of the length subfield **806** are used as error check bits of equal values, in an embodiment. For example, the two unused bits are set to logic one (11) if the value of the parity bit in the subfield **808** is a logic one (1), and are set to logic zero (00) if the value of the parity bit in the subfield **808** is a logic one (0), in an embodiment. In an embodiment, a receiving device configured according to the HEW protocol can detect that a data unit potentially conforms to the HEW communication protocol by detecting that the value L_LENGTH of the length subfield of the L_SIG field of the data unit is a multiple of 4 (e.g., if $L_LENGTH \% 3 \neq 4$). Then, the receiving device can check the values of the two unused bits (e.g., the least significant bits) of the length subfield of the data unit. If the two unused bits do not have a same value (e.g., if the two bits are not 00 or 11), then the receiving device determines that the L_LENGTH value was detected in error, or that the data unit does not conform to the HEW communication protocol. In this case, the receiving device stops processing the data unit, in an embodiment. Further, in an embodiment, if the two unused bits of the length subfield of the data unit have a same value (e.g., if the two bits are 00 or 11), then the receiving device additionally checks whether the value of the two unused bits corresponds to the value of the parity bit in the parity subfield **708**. If the value of the two unused bits does not correspond to the value of the parity bit, the receiving device decides that the L_SIG field was received in error, or that the data unit does not conform to the HEW protocol. In this case, the receiving device stops processing the data unit, in an embodiment. On the other hand, if the value of the two unused bits corresponds to the value of the parity bit, the receiving device decides the data unit conforms to the HEW protocol and that the L_SIG field was not received in error. In this case, the receiving device continues processing the data unit, in an embodiment. Further, in this case, the receiving device determines the number of HE OFDM symbols in the data unit by masking the two unused bits of the length subfield of L_SIG (e.g., replacing the two unused bits with logic zero (00)) to obtain the value of L_LENGTH and then computing the number of OFDM symbols according to

$$N_{SYM} = \left\lfloor \left(\frac{L_LENGTH + 3}{3} \times 4 \right) / T_{HEW} \right\rfloor \quad \text{Equation 18}$$

[0065] In another embodiment, the HEW portion **206** of the preamble **202** includes an indication HEW_LENGTH indicative of the length of the data unit **200**. For example, the HEW-SIGA field **214** of the data unit **200** includes a length indication subfield HEW_LENGTH indicative of the length of the data unit **200**. In an embodiment, a receiving device does not use the length field included in the L_SIG field **212** to calculate the number of OFDM symbols in the data unit **200**, but calculates the number of OFDM symbols in the data unit **200** based on the HEW_LENGTH indication included in the HEW portion **206**, such as a length indication included in the HEW-SIGA field **214** of the data unit **200**.

[0066] In an embodiment, the HEW_LENGTH length indication included in the HEW portion **206** indicates the number of OFDM symbols in the data unit **200**. In an embodiment in which only a single reduced tone spacing is used of HEW OFDM symbols of the data unit **200**, a single

N_{SYM} indication is included in the HEW preamble portion **204** of the data unit **200**. The N_{SYM} indication is set to indicate the number of OFDM symbols in the data unit **200**, in this embodiment. As an example, in an embodiment, the N_{SYM} indication included in the HEW portion **206** of the data unit **200** comprises nine bits. In this embodiment, the N_{SYM} indication can indicate a maximum 2^{12} data bytes, or a maximum to $2^{10.4}$ OFDM symbols in the data unit **200**. In another embodiment, in which both long HEW OFDM symbols and short HEW OFDM symbols are included in the data unit **200**, respective N_{SYM_long} and N_{SYM_short} indications are included in the HEW portion **206** of the data unit **200**. In any event, a receiving device that receives the data unit **200** can calculate the time duration $TXTIME$ corresponding to the data unit **200** based on the N_{SYM} indication and indications of the guard intervals GI_{short} and/or GI_{long} included in the data unit **200**. For example, in an embodiment and scenario, the receiving device calculates $TXTIME$ corresponding to the data unit **200** according to

$$T_{XTIME} = T_{HEW_Long} + GI_{Long} \times N_{SYM_Long} + (T_{HEW_Short} + GI_{Short}) \times N_{SYM_Short} \quad \text{Equation 19}$$

[0067] In another embodiment, the length indication included in the HEW portion **206** is set to indicate a length calculated, at the device that transmits the data unit **200**, based on an actual length of the data unit **200** and based on a predetermined rate such that a receiving device can at least approximately determine the actual length of the data unit **200** and using the predetermined rate. For example, a predetermined rate of 6 Mbps is used, in some embodiments. In one such embodiment, the transmitting device determines the value of the HEW_LENGTH indication according to

$$HEW_LENGTH = \left\lfloor \frac{T_{XTIME} - 20}{4} \right\rfloor - 3 \quad \text{Equation 20}$$

Alternatively, in another such embodiment, the transmitting device determines the value of the HEW_LENGTH indication according to

$$HEW_LENGTH = \left\lfloor \frac{T_{XTIME} - 20}{4} \times 3 \right\rfloor - 3 \quad \text{Equation 21}$$

[0068] In some embodiment, predetermined rates other than 6 Mbps are used for setting the HEW_LENGTH indication included in the data unit **200**, and values of the HEW_LENGTH indication are determined such that a receiving device can at least approximately determine the actual length of the data unit **200** using the corresponding predetermined rates other than 6 Mbps. Generally speaking, with a relatively lower rate used for setting the HEW_LENGTH indication included in the data unit **200**, fewer bits are needed to signal HEW_LENGTH in the data unit **200**. As just an example, in some embodiments, a predetermined rate of 3 Mbps is used. In one such embodiment, the transmitting device determines the value of the HEW_LENGTH indication according to

$$HEW_LENGTH = \left\lfloor \frac{T_{XTIME} - 20}{4} \right\rfloor \times 3 - 3 \quad \text{Equation 22}$$

Alternatively, in another such embodiment, the transmitting device determines the value of the HEW_LENGTH indication according to

$$\text{HEW_LENGTH} = \left\lfloor \frac{\text{TXTIME} - 20}{8} \times 3 \right\rfloor - 3 \quad \text{Equation 23}$$

[0069] In such embodiments, in which the predetermined rate of 6 Mbps or the predetermined rate of 3 Mbps is used, ambiguity of the number of OFDM symbols when the number of OFDM symbols is calculated at the receiving device does not arise. A receiving device that receives the data unit **200** calculates the number of HEW OFDM symbols in the data unit **200**, based on the HEW_LENGTH indication included in the data unit **200** according to

$$N_{\text{HEW_SYM}} = \left\lfloor \left(\frac{\text{HEW_LENGTH} + 3}{3} \times M \right) / T_{\text{HEW_SYM}} \right\rfloor \quad \text{Equation 24}$$

where M=4 when the predetermined rate of 6 Mbps is used, and M=8 when the predetermined rate of 3 Mbps is used.

[0070] As yet another example, in another embodiment, a predetermined rate of 1.5 Mbps is used. In this embodiment, the HEW_LENGTH indication comprises two fewer bits compared to the number of bits needed for the HEW_LENGTH indication used with a predetermined rate of 6 Mbps. In one embodiment in which a predetermined rate of 1.5 Mbps is used, the transmitting device determines the value of the HEW_LENGTH indication according to

$$\text{HEW_LENGTH} = \left\lfloor \frac{\text{TXTIME} - 20}{16} \times 3 \right\rfloor - 3 \quad \text{Equation 25}$$

[0071] In this embodiment, ambiguity arises when the number of OFDM symbols is calculated based on the value of the HEW_LENGTH indication in some situations. For example, if a guard interval of 0.4 μs is used with HEW OFDM symbols, ambiguity arises when the number of HEW OFDM symbols is in the set [5 11 17 22 28 34 39 45 . . .]. Similarly, if a guard interval of 0.8 μs is used with HEW OFDM symbols, ambiguity arises when the number of HEW OFDM symbols is in the set [6 13 19 26 33 39 46 53 . . .], in an embodiment. In an embodiment, the HEW preamble portion **206** (e.g., the HEW-SIGA field includes an ambiguity that is set based on an ambiguity table stored in the transmitting device. For example, based on the particular guard interval being utilized with HEW OFDM symbol, the ambiguity indication is set to a logic one (1) if the number of HEW OFDM symbols in the data unit is indicated in the ambiguity table as arising in ambiguity. On the other hand, the ambiguity indication is set to a logic zero (0) if the number of HEW OFDM symbols in the data unit is not indicated in the ambiguity table as arising in ambiguity, in an embodiment.

[0072] In an embodiment, a receiving device that receives the data unit **200** determines a number of HEW OFDM symbols in the data unit **200** based on (i) the indication of the guard interval being used with the HEW OFDM symbols and (ii) the GI ambiguity indication included in the HEW preamble portion **206** of the data unit **200**. In an embodi-

ment, the receiving device calculates the number of HEW OFDM symbols in the data unit **200** according to

$$N_{\text{HEW_SYM}} = \left\lfloor \left(\frac{\text{HEW_LENGTH} + 3}{3} \times 16 \right) / T_{\text{HEW_SYM}} \right\rfloor - \text{Ambiguity} \quad \text{Equation 26}$$

where the duration $T_{\text{HEW_SYM}}$ is determined by the particular guard interval being utilized as indicated by the guard interval indication in the data unit **200**, and Ambiguity is either 0 or 1 as indicated by the ambiguity indication in the data unit **200**.

[0073] Alternatively, in another embodiment in which a predetermined rate of 1.5 Mbps is used, the value of the HEW_LENGTH indication is determined according to

$$\text{HEW_LENGTH} = \left\lfloor \frac{\text{TXTIME} - 20}{16} \times 3 \right\rfloor - 3 \quad \text{Equation 27}$$

[0074] In this embodiment, ambiguity of the number of OFDM symbols when the number of OFDM symbols is calculated at the receiving device does not arise. Accordingly, an ambiguity indication is not needed, in this embodiment. In this embodiment, a receiving device that receives the data unit **200** determines a number of HEW OFDM symbols in the data unit **200** based on the indication of the guard interval being used with the HEW OFDM symbols included in the HEW preamble portion **206** of the data unit **200**. In an embodiment, the receiving device calculates the number of HEW OFDM symbols in the data unit **200** according to

$$N_{\text{HEW_SYM}} = \left\lfloor \left(\frac{\text{HEW_LENGTH} + 3}{3} \times 16 \right) / T_{\text{HEW_SYM}} \right\rfloor \quad \text{Equation 28}$$

where the duration $T_{\text{HEW_SYM}}$ is determined based on the particular guard interval being utilized as indicated by the guard interval indication in the data unit **200**.

[0075] In some embodiments, in which the HEW OFDM symbols of the data unit **200** include both short HEW OFDM symbols generated using a first tone spacing and long HEW OFDM symbols generated using a second tone spacing, and in which the value of the HEW_LENGTH indication is calculated based on a pre-determined rate, for example as described above with respect to the Equations 18-21, the HEW preamble portion **206** (e.g., the HEW-SIGA field **214**) includes an indication of the number of short symbols $N_{\text{SYM_Short}}$ in addition to the HEW_LENGTH indication in the HEW preamble portion **206**. In an embodiment, a receiving device that receives the data unit **200** determines the number of long HEW OFDM symbols $N_{\text{SYM_Long}}$ in the data unit **200** based on the indication of the number of short HEW OFDM symbols $N_{\text{SYM_Short}}$ included in the data unit **200**. For example, in an embodiment, the receiving device determines the number of long HEW OFDM symbols $N_{\text{SYM_Long}}$ in the data unit **200** according to

$$N_{SYM_Long} = \left\lfloor \left(\frac{L_LENGTH+3}{3} \times M - T_{HEW_PREAMBLE} - (3.2 + GI_{Short}) \times N_{SYM_Short} \right) / (12.8 + GI_{Long}) \right\rfloor \quad \text{Equation 29}$$

where M=4 when the predetermined rate of 6 Mbps is used, M=8 when the predetermined rate of 3 Mbps is used, and M=16 when the predetermined rate of 1.5 Mbps is used.

[0076] Alternatively, in another embodiment in which the HEW OFDM symbols of the data unit **200** include both short HEW OFDM symbols generated using a first tone spacing and long HEW OFDM symbols generated using a second tone spacing, and in which the value of the HEW_LENGTH indication is calculated based on a pre-determined rate, for example as described above with respect to the Equations 18-21, the HEW preamble portion **206** (e.g., the HEW-SIGA field **214**) includes respective ambiguity indications to indicate when ambiguity conditions are met when the number of short HEW OFDM symbols and the number of long HEW OFDM symbols are calculated at the receiving device that receives the data unit **200**. For example, the HEW PREAMBLE portion **206** (e.g., the HEW-SIGA field **214**) includes a first ambiguity bit $Ambiguity_{Long}$ indicative of ambiguity in calculating the number of short HEW OFDM symbols N_{SYM_Long} , and a second ambiguity bit $Ambiguity_{Short}$ indicative of ambiguity in calculating the number of short HEW OFDM symbols N_{SYM_Short} . In an embodiment, the transmitting device sets the $Ambiguity_{Long}$ bit to logic one (1) when a stored condition for long HEW OFDM symbol ambiguity is met for the data unit **200**. Similarly, the transmitting device sets the $Ambiguity_{Short}$ bit to logic one (1) when a stored condition for short HEW OFDM symbol ambiguity is met for the data unit **200**, in an embodiment. The stored conditions for long HEW OFDM symbol ambiguity and short HEW OFDM symbol ambiguity are based on various factors, such as one or more of (i) the particular values of GI_{Short} and GI_{Long} being utilized for the data unit **200**, (ii) the number of HEW OFDM symbols in the data unit **200**, (iii) the number of long HEW OFDM symbols in the data unit **200**, (iv) the number of HEW OFDM symbols in the data unit **200**, etc., in an embodiment.

[0077] In this embodiment, a receiving device that receives the data unit **200** calculates a number of long HEW OFDM symbols N_{SYM_Long} in the data unit **200** and a number of short HEW OFDM symbols N_{SYM_Short} in the data unit **200** based on the indications included in the data unit **200**. In an embodiment, the receiving device calculates the number of long HEW OFDM symbols N_{SYM_Long} according to

$$N_{SYM_Long} = \left\lfloor \left(\frac{L_LENGTH+3}{3} \times M - T_{HEW_PREAMBLE} \right) / (12.8 + GI_{Long}) \right\rfloor - Ambiguity_{Long} \quad \text{Equation 30}$$

and then calculates the number of long HEW OFDM symbols N_{SYM_Long} according to

$$N_{SYM_Short} = \left\lfloor \left(\frac{L_LENGTH+3}{3} \times M - T_{HEW_PREAMBLE} - N_{SYM_Long} \times (12.8 + GI_{Long}) \right) / (3.2 + GI_{Short}) \right\rfloor - Ambiguity_{Short} \quad \text{Equation 31}$$

In Equations 23 and 24, M=4 when the predetermined rate of 6 Mbps is used, M=8 when the predetermined rate of 3 Mbps is used, and M=16 when the predetermined rate of 1.5 Mbps is used, in various embodiments.

[0078] FIG. 9 is a flow diagram of an example method **900** for generating a data unit, according to an embodiment. With reference to FIG. 1, the method **900** is implemented by the network interface **16**, in an embodiment. For example, in one such embodiment, the PHY processing unit **20** is configured to implement the method **900**. According to another embodiment, the MAC processing **18** is also configured to implement at least a part of the method **900**. With continued reference to FIG. 1, in yet another embodiment, the method **900** is implemented by the network interface **27** (e.g., the PHY processing unit **29** and/or the MAC processing unit **28**). In other embodiments, the method **900** is implemented by other suitable network interfaces.

[0079] At block **9002**, a first set of OFDM symbols for a first portion of the data unit is generated. In an embodiment, OFDM symbols of the first set of OFDM symbols are generated with a first tone spacing. In an embodiment, the first portion of the data unit is a legacy portion that conforms to a legacy communication protocol. In an embodiment, the first tone spacing is a normal tone spacing defined by a legacy communication protocol.

[0080] At block **904**, a second set of OFDM symbols for a second portion of the data unit is generated. In an embodiment, at least some OFDM symbols of the second set of OFDM symbols are generated with a second tone spacing which is different from the first tone spacing. In an embodiment, the second portion of the data unit is a non-legacy portion that conforms to a non-legacy communication protocol, such as the HEW communication protocol. In an embodiment, the second tone spacing is a reduced tone spacing that is a fraction of the normal tone spacing (e.g., 1/2, 1/4, etc. of the normal tone spacing) used with the first set of OFDM symbols.

[0081] At block **906**, a value for a length indicator indicative of the duration of the data unit is determined. In an embodiment, the value of the length indicator is determined based on the first tone spacing used with the OFDM symbols in the first set of OFDM symbols generated at block **902** and the second tone spacing used with the at least some OFDM symbols of the second set of OFDM symbols generated at block **904**. In an embodiment, the value for the length indicator is determined using Equation 1 or Equation 6 discussed above. In an embodiment in which the value for the length indicator is determined using Equation 1 or Equation 6, transmission time (TXTIME) in Equation 1 or in Equation 6 is determined using symbol duration of OFDM symbols generated using the first tone spacing and symbol duration of OFDM symbols generated using the second tone spacing, wherein duration of the OFDM symbols is determined as a function of the tone spacing used with the OFDM symbols. For example, transmission time is

determined using symbol duration of the OFDM symbols generated with the first tone spacing, and OFDM symbols generated with the second tone spacing, according to Equation 2, in an embodiment.

[0082] At block 908, the first portion of the data unit is generated. In an embodiment, the first portion is generated to include the first set of OFDM symbols generated at block 902 and a length indicator set to the value determined at block 906. In an embodiment, the first portion of the data unit corresponds to the legacy preamble portion 204 of the data unit 200 of FIG. 2. In another embodiment, the first portion corresponds to another portion of the data unit 200 of FIG. 2 or corresponds to a first portion of a suitable data unit other than the data unit 200 of FIG. 2. In an embodiment, the first portion is generated to include a signal field (e.g., the L-SIG field 212 in FIG. 2), and the signal field is generated to include the length indicator. In another embodiment, the length indicator is included in the first portion in a field other than a signal field.

[0083] At block 910, the second portion of the data unit is generated. In an embodiment, the second portion is generated to include the second set of OFDM symbols generated at block 904. In an embodiment, the second portion of the data unit corresponds to the preamble portion 206 and the data portion 222 of the data unit 200 of FIG. 2. In another embodiment, the second portion corresponds to another portion of the data unit 200 of FIG. 2 or corresponds to a second portion of a suitable data unit other than the data unit 200 of FIG. 2.

[0084] At block 912, the data unit is generated. In an embodiment, the data unit is generated to include the first portion generated at block 908 and the second set of OFDM symbols generated at block 910. In an embodiment, the data unit 200 of FIG. 2 is generated. In another embodiment, a suitable unit different from the data unit 200 of FIG. 2 is generated.

[0085] FIG. 10 is a flow diagram of an example method 1000 for processing a data unit, according to an embodiment. With reference to FIG. 1, the method 1000 is implemented by the network interface 16, in an embodiment. For example, in one such embodiment, the PHY processing unit 20 is configured to implement the method 1000. According to another embodiment, the MAC processing 18 is also configured to implement at least a part of the method 1000. With continued reference to FIG. 1, in yet another embodiment, the method 1000 is implemented by the network interface 27 (e.g., the PHY processing unit 29 and/or the MAC processing unit 28). In other embodiments, the method 2000 is implemented by other suitable network interfaces.

[0086] At block 1002, the data unit is received. In an embodiment, the data unit is received via an OFDM communication channel. In an embodiment, the data unit 200 of FIG. 2 is received. In another embodiment, a suitable data unit different from the data unit 200 of FIG. 2 is received. In an embodiment, the data unit includes a first set of one or more short OFDM symbols generated a normal tone spacing and a second set of one or more OFDM symbols generated using a reduced tone spacing. In an embodiment, the reduced tone spacing is a fraction of the normal tone spacing. For example, the reduced tone spacing is $\frac{1}{2}$ of the normal tone spacing, $\frac{1}{4}$ of the normal tones spacing, $\frac{1}{8}$ of the normal tone spacing, etc. In an embodiment, the ratio between the normal spacing and the reduced spacing is

known a priori at the receiving device. In another embodiment, the ratio between the normal spacing and the reduced spacing is indicated in the data unit (e.g., in a signal field of the data unit). In an embodiment, the data unit includes an OFDM symbol indicator indicative of one or both of (i) a number of short OFDM symbols in the first set of OFDM symbols and a number of short OFDM symbols in the second set of OFDM symbols. In an embodiment, the OFDM symbol indication is included in a signal field of the data unit. For example, referring to FIG. 2, the OFDM symbol indicator is included in the HEW-SIG-A field 214 or in the HEW-SIG-B field 200, in an embodiment.

[0087] At block 1004, the number of short OFDM symbols in the first set of OFDM symbols and the number of long OFDM symbols in the second set of OFDM symbols are determined. In an embodiment, the number of short OFDM symbols and the number of long OFDM symbols are determined based on the OFDM symbol indicator included in the data unit. In an embodiment, the data unit further includes a length field indicative of a duration of at least a portion of the data unit (e.g., a duration of a non-legacy portion of the data unit, a duration of a data portion of the data unit, a duration of the entire data unit, etc.). In an embodiment, the length indicator is included in a legacy portion of the data unit. For example, referring to FIG. 2, the length indicator is included in the L-SIG field 212, in an embodiment. In another embodiment, the length indicator is included in a non-legacy portion of the data unit. For example, referring to FIG. 2, the length indicator is included in the HEW-SIGA field 214 or in the HEW-SIGB field 220, in an embodiment. In an embodiment, determination of the number of short OFDM symbols and the number of long OFDM symbols is further based on the length indicator included in the data unit.

[0088] In an embodiment, the OFDM symbol indicator directly indicates the number of short OFDM symbols and the number of long OFDM symbols, and the number of short OFDM symbols and the number of long OFDM symbols are determined based on the direct indications of the number of short OFDM symbols and the number of long OFDM symbols. In another embodiment, the OFDM symbol indicator indicates only one of the number of short OFDM symbols and the number of long OFDM symbols, and block 1004 includes determining the other one of the number of short OFDM symbols and the number of long OFDM symbols based on the OFDM symbol indicator and the length indicator. For example, the number of long OFDM symbols is determined at block 1004 based on a number of short OFDM symbols indicated by the OFDM symbol indicator and the length indicator according to Equation 9, in an embodiment. As another example, the number of long OFDM symbols is determined at block 1004 based on a number of short OFDM symbols indicated by the OFDM symbol indicator and the length indicator according to Equation 29, in another embodiment.

[0089] In some embodiments, the OFDM symbol indicator includes a first ambiguity bit that indicates ambiguity in calculating the number of long OFDM symbols a second ambiguity bit that indicates ambiguity in calculating the number of short OFDM symbols. In one such embodiment, determination at block 1004 includes determining the number of long OFDM symbols based on the first ambiguity bit and the length indicator, and then determining the number of short OFDM symbols based on the second ambiguity bit, the

length indicator, and the determined number of short OFDM symbols. For example, in an embodiment, the number of long OFDM symbols and the number of short OFDM symbols are determined according to Equation 10 and Equation 11, respectively. As another example, in another embodiment, the number of long OFDM symbols and the number of short OFDM symbols are determined according to Equation 30 and Equation 31, respectively.

[0090] When implemented in hardware, the hardware may comprise one or more of discrete components, an integrated circuit, an application-specific integrated circuit (ASIC), etc.

[0091] While the present invention has been described with reference to specific examples, which are intended to be illustrative only and not to be limiting of the invention, changes, additions and/or deletions may be made to the disclosed embodiments without departing from the scope of the invention.

[0092] In addition, further aspects of the present invention relates to one or more of the following clauses.

[0093] In an embodiment, a method for generating a physical layer (PHY) data unit for transmission via a communication channel includes generating a first set of orthogonal frequency domain multiplexing (OFDM) symbols for a first portion of the PHY data unit, wherein OFDM symbols of the first set of OFDM symbols are generated with a first OFDM tone spacing, and generating a second set of OFDM symbols for a second portion of the PHY data unit, wherein at least some OFDM symbols of the second set of OFDM symbols are generated with a second tone spacing different from the first tone spacing. The method further includes determining, based on the first tone spacing and the second tone spacing, a value for a length indicator indicative of a duration of the PHY data unit. The method further still includes generating the first portion of the PHY data unit to include (i) the first set of OFDM symbols and (ii) the length indicator set to the determined value, and generating the second portion of the PHY data unit to include the second set of OFDM symbols. The method additionally includes generating the PHY data unit to include the first portion and the second portion.

[0094] In other embodiments, the method includes any suitable combination of one or more of the following features.

[0095] The first portion of the preamble includes a first signal field, and wherein the length indicator is included in a length subfield of the first signal field.

[0096] The length subfield of the first signal field comprises m bits.

[0097] Generating the length indicator includes constraining the value of the length indicator to a maximum of n bits, wherein m and n are integers, wherein $m < n$.

[0098] The method further includes using one or more bits of the length subfield that are not used for indicating length for a purpose other than indicating length.

[0099] Using the one or more bits of the length subfield that are not used for indicating length for the purpose other than indicating length comprises using the one or more bits as error checking bits to improve reliability of the first signal field.

[0100] Determining the value for the length indicator includes constraining the value of the length indicator to be indivisible by 3.

[0101] Determining the value for the length indicator includes determining a transmission time corresponding to

transmission of the second set of OFDM symbols as a function of a number of OFDM symbols in the second set of OFDM symbols and a duration of each OFDM symbol in the second set of OFDM symbols.

[0102] Determining the value for the length indicator includes applying, to the determined transmission time, a conversion factor that corresponds to a predetermined data rate to convert the transmission time to a length value that at least approximates the actual transmission time according to the predetermined data rate.

[0103] Determining the value for the length indicator includes applying a ceiling function to the transmission time to generate an integer value corresponding to the transmission time, wherein applying the ceiling function comprises applying the ceiling function to the converted transmission time after applying the conversion factor to the transmission time.

[0104] The method further includes generating a second signal field to be included in the second portion of the PHY data unit, wherein the signal field includes a guard interval indication set to indicate a particular guard interval used with at least some OFDM symbols of the second set of OFDM symbols.

[0105] The guard interval indication comprises two bits set to indicate one of four guard intervals available for generating the at least some OFDM symbols of the second set of OFDM symbols.

[0106] The first tone spacing is a normal tone spacing and the second tone spacing is a reduced tone spacing that is a fraction of the normal tone spacing.

[0107] The second set of OFDM symbols includes (i) a first subset of one or more short OFDM symbols generated using the normal tone spacing and (ii) a second subset of one or more long OFDM symbols generated using the reduced tone spacing.

[0108] Generating the second portion of the PHY data unit includes indicating, in the second portion of the PHY data unit, a number of short OFDM symbols in the first subset of OFDM symbols such that a receiving device can determine a number of long OFDM symbols in the second portion of the PHY data unit based on (i) the value of the length indicator in the first portion of the PHY data unit and (ii) the indicated number of short OFDM symbols in the second portion of the PHY data unit.

[0109] Generating the second portion of the PHY data unit includes including, in the second portion of the PHY data unit, (i) a first ambiguity indicator to indicate an ambiguity in determining a number of short OFDM symbols in the first subset of OFDM symbols based on the value of the length indicator in the first portion of the PHY data unit and (ii) a second ambiguity indicator to indicate an ambiguity in determining a number of long OFDM symbols in the second subset of OFDM symbols based on the value of the length indicator in the first portion of the PHY data unit.

[0110] The method further includes generating a second length indicator to be included in the second portion of the PHY data unit, including determining, based at least in part on the second tone spacing, a value for the second length indicator such that a receiving device can determine a number of OFDM symbols in the second set of OFDM symbols based on the value of the second length indicator.

[0111] The second length indicator indicates one or more of (i) the number of OFDM symbols in the second set of OFDM symbols, (ii) a number of short OFDM symbols in

the second set of OFDM symbols, the short OFDM symbols generated using the first tone spacing, (iii) a number of long OFDM symbols in the second set of OFDM symbols, the long OFDM symbols generated using the second tone spacing, (iv) a first ambiguity indicator to indicate an ambiguity in determining a number short OFDM symbols in the second set of OFDM symbols, the short OFDM symbols generated using the first tone spacing, and (v) a second ambiguity indicator to indicate an ambiguity in determining a number of long OFDM symbols in the second set of OFDM symbols, the long OFDM symbols generated using the second tone spacing.

[0112] The value for the second length indicator is determined based on predetermined data rate such that the receiving device can determine the number of OFDM symbols in the second set of OFDM symbols using the predetermined data rate.

[0113] The predetermined data rate is less than 6 megabits per second (Mbps).

[0114] In another embodiment, an apparatus comprises a network interface configured to generate a first set of orthogonal frequency domain multiplexing (OFDM) symbols for a first portion of a physical layer (PHY) data unit, wherein OFDM symbols of the first set of OFDM symbols are generated with a first OFDM tone spacing, and generate a second set of OFDM symbols for a second portion of the PHY data unit, wherein at least some OFDM symbols of the second set of OFDM symbols are generated with a second tone spacing different from the first tone spacing. The network interface is further configured to determine, based on the first tone spacing and the second tone spacing, a value for a length indicator indicative of a duration of the PHY data unit. The network interface is further still configured to generate the first portion of the PHY data unit to include (i) the first set of OFDM symbols and (ii) the length indicator set to the determined value, and generate the second portion of the PHY data unit to include the second set of OFDM symbols. The network interface is additionally configured to generate the PHY data unit to include the first portion and the second portion.

[0115] In other embodiments, the apparatus includes any suitable combination of one or more of the following features.

[0116] The first portion of the preamble includes a first signal field, and wherein the length indicator is included in a length subfield of the first signal field.

[0117] The length subfield of the first signal field comprises m bits.

[0118] The network interface is configured to constrain the value of the length indicator to a maximum of n bits, wherein m and n are integers, wherein $m < n$.

[0119] The network interface is further configured to use one or more bits of the length subfield that are not used for indicating length for a purpose other than indicating length.

[0120] The network interface is configured to use the one or more bits of the length subfield that are not used for indicating length as error checking bits to improve reliability of the first signal field.

[0121] The network interface is configured to constrain the value of the length indicator such that the value is not divisible by 3.

[0122] The network interface is configured to determine the value for the length indicator at least by determining a transmission time corresponding to transmission of the

second set of OFDM symbols as a function of a number of OFDM symbols in the second set of OFDM symbols and a duration of each OFDM symbol in the second set of OFDM symbols, applying, to the determined transmission time, a conversion factor that corresponds to a predetermined data rate to convert the transmission time to a length value that at least approximates the actual transmission time according to the predetermined data rate, and applying a ceiling function to the transmission time to generate an integer value corresponding to the transmission time, wherein applying the ceiling function comprises applying the ceiling function to the converted transmission time after applying the conversion factor to the transmission time.

[0123] The network interface is further configured to generate a second signal field to be included in the second portion of the PHY data unit, wherein the signal field includes a guard interval indication set to indicate a particular guard interval used with at least some OFDM symbols of the second set of OFDM symbols.

[0124] The guard interval indication comprises two bits set to indicate one of four guard intervals available for generating the at least some OFDM symbols of the second set of OFDM symbols.

[0125] The first tone spacing is a normal tone spacing and the second tone spacing is a reduced tone spacing that is a fraction of the normal tone spacing.

[0126] The second set of OFDM symbols includes (i) a first subset of one or more short OFDM symbols generated using the normal tone spacing and (ii) a second subset of one or more long OFDM symbols generated using the reduced tone spacing.

[0127] The network interface is configured to indicate, in the second portion of the PHY data unit, a number of short OFDM symbols in the first subset of OFDM symbols such that a receiving device can determine a number of long OFDM symbols in the second portion of the PHY data unit based on (i) the value of the length indicator in the first portion of the PHY data unit and (ii) the indicated number of short OFDM symbols in the second portion of the PHY data unit.

[0128] The network interface is configured to indicate, in the second portion of the PHY data unit, (i) a first ambiguity indicator to indicate an ambiguity in determining a number of short OFDM symbols in the first subset of OFDM symbols based on the value of the length indicator in the first portion of the PHY data unit and (ii) a second ambiguity indicator to indicate an ambiguity in determining a number of long OFDM symbols in the second subset of OFDM symbols based on the value of the length indicator in the first portion of the PHY data unit.

[0129] The network interface is further configured to generate a second length indicator to be included in the second portion of the data unit, wherein generating the second length indicator includes determining, based at least in part on the second tone spacing, a value for the second length indicator such that a receiving device can determine a number of OFDM symbols in the second set of OFDM symbols based on the value of the second length indicator.

[0130] The second length indicator indicates one or more of (i) the number of OFDM symbols in the second set of OFDM symbols, (ii) a number of short OFDM symbols in the second set of OFDM symbols, the short OFDM symbols generated using the first tone spacing, (iii) a number of long OFDM symbols in the second set of OFDM symbols, the

long OFDM symbols generated using the second tone spacing, (iv) a first ambiguity indicator to indicate an ambiguity in determining a number short OFDM symbols in the second set of OFDM symbols, the short OFDM symbols generated using the first tone spacing, and (v) a second ambiguity indicator to indicate an ambiguity in determining a number of long OFDM symbols in the second set of OFDM symbols, the long OFDM symbols generated using the second tone spacing.

[0131] The value for the second length indicator is determined based on predetermined data rate such that the receiving device can determine the number of OFDM symbols in the second set of OFDM symbols using the predetermined data rate.

[0132] The predetermined data rate is less than 6 megabits per second (Mbps).

[0133] In yet another embodiment, a method for processing a physical layer (PHY) data unit includes receiving the PHY data unit via an orthogonal frequency division multiplexing (OFDM) communication channel. The PHY data unit includes (i) a first set of one or more short OFDM symbols generated using a normal tone spacing and (ii) a second set of one or more long OFDM symbols generated using a reduced tone spacing, (iii) an OFDM symbol indicator indicative of a number of OFDM symbols in at least one of (a) the first set of OFDM symbols and (b) the second set of OFDM symbols; The method additionally includes determining, based at least in part on the OFDM symbol indicator, (i) a number of short OFDM symbols in the set of one or more short OFDM symbols and (ii) a number of long OFDM symbols in the set of one or more long OFDM symbols.

[0134] In other embodiments, the method includes any suitable combination of one or more of the following features.

[0135] The PHY data unit further includes a length indicator indicative of a duration of at least a portion of the PHY data unit.

[0136] Determining the number of short OFDM symbols and the number of long OFDM symbols is further based on the length indicator.

[0137] The PHY data unit (i) conforms to a first communication protocol, (ii) includes a legacy portion decodable by legacy devices that conform to a second communication protocol but do not conform to the first communication protocol, and wherein the length indicator is included in the legacy portion to allow a legacy device to at least approximately determine the duration of the PHY data unit.

[0138] The OFDM symbol indicator indicates the number short OFDM symbols, and wherein determining the number of short OFDM symbols and the number of long OFDM symbols includes determining the number of long OFDM symbols based on the length indicator and the indicated number of short OFDM symbols.

[0139] The OFDM symbol indicator includes (i) a first ambiguity indicator to indicate an ambiguity in determining a number of long OFDM symbols and (ii) a second ambiguity indicator to indicate an ambiguity in determining a number of short OFDM symbols,

[0140] Determining the number of long OFDM symbols and the number of short OFDM symbols includes determining the number of long OFDM symbols based on the length indicator and the first ambiguity indicator, and determining the number of short OFDM symbols based on the length

indicator, the second ambiguity bit, and the determined number of long OFDM symbols.

[0141] The PHY data unit (i) conforms to a first communication protocol and (ii) includes a legacy portion decodable by legacy devices that conform to a second communication protocol but do not conform to the first communication protocol, and wherein the length indicator is included in a non-legacy portion of the PHY data unit, the non-legacy portion not decodable by communication device that do not conform to the first communication protocol.

[0142] The OFDM symbol indicator includes a first set of bits that indicate the number of long OFDM symbols and a second set of bits that indicate the number of short OFDM symbols.

[0143] The length indicator indicates a length calculated based on an actual length of the PHY data unit and based on a predetermined rate such that a receiving device can at least approximately determine the actual length of the PHY data unit based the length indicator and the predetermined rate.

[0144] The predetermined rate is lower than a lowest rate defined by the second communication protocol.

[0145] The OFDM symbol indicator includes (i) a first ambiguity indicator to indicate an ambiguity in determining a number of long OFDM symbols and (ii) a second ambiguity indicator to indicate an ambiguity in determining a number of short OFDM symbols, and wherein determining the number of long OFDM symbols and the number of short OFDM symbols includes determining the number of long OFDM symbols based on the length indicator and the first ambiguity indicator, and determining the number of short OFDM symbols based on the length indicator, the second ambiguity bit, and the determined number of long OFDM symbols.

[0146] The reduced OFDM spacing is $\frac{1}{4}$ fraction of the normal OFDM spacing.

[0147] In still another embodiment, an apparatus comprises a network interface configured to receive a physical layer (PHY) data unit via an orthogonal frequency division multiplexing (OFDM) communication channel. The PHY data unit includes (i) a first set of one or more short OFDM symbols generated using a normal tone spacing and (ii) a second set of one or more long OFDM symbols generated using a reduced tone spacing, (iii) an OFDM symbol indicator indicative of a number of OFDM symbols in at least one of (a) the first set of OFDM symbols and (b) the second set of OFDM symbols. The network interface is further configured to determine, based at least in part on the OFDM symbol indicator, (i) a number of short OFDM symbols in the set of one or more short OFDM symbols and (ii) a number of long OFDM symbols in the set of one or more long OFDM symbols.

[0148] In other embodiments, the apparatus includes any suitable combination of one or more of the following features.

[0149] The PHY data unit further includes a length indicator indicative of a duration of at least a portion of the PHY data unit.

[0150] The network interface is configured to determine the number of short OFDM symbols and the number of long OFDM symbols further based on the length indicator.

[0151] The PHY data unit (i) conforms to a first communication protocol, (ii) includes a legacy portion decodable by

legacy devices that conform to a second communication protocol but do not conform to the first communication protocol.

[0152] The length indicator is included in the legacy portion to allow a legacy device to at least approximately determine the duration of the PHY data unit.

[0153] The OFDM symbol indicator indicates the number of short OFDM symbols,

[0154] The network interface is configured to determine the number of long OFDM symbols based on the length indicator and the indicated number of short OFDM symbols.

[0155] The OFDM symbol indicator includes (i) a first ambiguity indicator to indicate an ambiguity in determining a number of long OFDM symbols and (ii) a second ambiguity indicator to indicate an ambiguity in determining a number of short OFDM symbols,

[0156] The network interface is configured to determine the number of long OFDM symbols based on the length indicator and the first ambiguity indicator, and determine the number of short OFDM symbols based on the length indicator, the second ambiguity bit, and the determined number of long OFDM symbols.

[0157] The PHY data unit (i) conforms to a first communication protocol and (ii) includes a legacy portion decodable by legacy devices that conform to a second communication protocol but do not conform to the first communication protocol, and wherein the length indicator is included in a non-legacy portion of the PHY data unit, the non-legacy portion not decodable by communication device that do not conform to the first communication protocol.

[0158] The OFDM symbol indicator includes a first set of bits that indicate the number of long OFDM symbols and a second set of bits that indicate the number of short OFDM symbols.

[0159] The length indicator indicates a length calculated based on an actual length of the PHY data unit and based on a predetermined rate such that a receiving device can at least approximately determine the actual length of the PHY data unit based the length indicator and the predetermined rate.

[0160] The predetermined rate is lower than a lowest rate defined by the second communication protocol.

[0161] The OFDM symbol indicator includes (i) a first ambiguity indicator to indicate an ambiguity in determining a number of long OFDM symbols and (ii) a second ambiguity indicator to indicate an ambiguity in determining a number of short OFDM symbols,

[0162] The network interface is configured to determine the number of long OFDM symbols based on the length

indicator and the first ambiguity indicator, and determine the number of short OFDM symbols based on the length indicator, the second ambiguity bit, and the determined number of long OFDM symbols.

[0163] The reduced OFDM spacing is $\frac{1}{4}$ fraction of the normal OFDM spacing.

What is claimed is:

1. A method for generating a physical layer (PHY) data unit for transmission via a communication channel, the method comprising:

generating a first set of orthogonal frequency domain multiplexing (OFDM) symbols for a first portion of the PHY data unit, wherein OFDM symbols of the first set of OFDM symbols are generated with a first OFDM tone spacing;

generating a second set of OFDM symbols for a second portion of the PHY data unit, wherein at least some OFDM symbols of the second set of OFDM symbols are generated with a second tone spacing different from the first tone spacing;

determining, based on the first tone spacing and the second tone spacing, a value for a length indicator indicative of a duration of the PHY data unit, wherein determining the value for the length indicator includes determining a transmission time corresponding to transmission of the second set of OFDM symbols as a function of a number of OFDM symbols in the second set of OFDM symbols and a duration of each OFDM symbol in the second set of OFDM symbols, and

applying, to the determined transmission time, (i) a conversion factor that corresponds to a predetermined data rate, and (ii) a ceiling function, to generate an integer value corresponding to the transmission time;

generating the first portion of the PHY data unit to include (i) the first set of OFDM symbols and (ii) the length indicator set to the determined value, wherein the first portion of the PHY data unit is generated such that the length indicator is included in a legacy portion of a preamble of the PHY data unit;

generating the second portion of the PHY data unit to include the second set of OFDM symbols; and

generating the PHY data unit to include the first portion and the second portion.

* * * * *