



US008181874B1

(12) **United States Patent**
Wan et al.

(10) **Patent No.:** **US 8,181,874 B1**
(45) **Date of Patent:** **May 22, 2012**

(54) **METHODS AND APPARATUS FOR FACILITATING CAPTURE OF MAGNETIC CREDIT CARD DATA ON A HAND HELD DEVICE**

| | | | | |
|--------------|-----|---------|--------------------|---------|
| 2004/0177045 | A1 | 9/2004 | Brown | |
| 2005/0074147 | A1* | 4/2005 | Smith et al. | 382/115 |
| 2005/0247787 | A1* | 11/2005 | Von Mueller et al. | 235/449 |
| 2009/0321510 | A1* | 12/2009 | Day et al. | 235/375 |
| 2010/0109102 | A1 | 5/2010 | Chen et al. | |
| 2011/0198395 | A1* | 8/2011 | Chen | 235/380 |
| 2011/0266340 | A9* | 11/2011 | Block et al. | 235/379 |

(75) Inventors: **Hong Wan**, Menlo Park, CA (US);
Raymond Merrill, Jr., Menlo Park, CA (US)

OTHER PUBLICATIONS

(73) Assignee: **MCube Inc.**, San Jose, CA (US)

Non-Final Office Action for U.S. Appl. No. 12/940,023, mailed on Oct. 26, 2011, 5 pages.

(*) Notice: Subject to any disclaimer, the term of this patent is extended or adjusted under 35 U.S.C. 154(b) by 0 days.

Requirement for Restriction/Election for U.S. Appl. No. 12/717,070, mailed on Dec. 2, 2011, 5 pages.

Notice of Allowance for U.S. Appl. No. 12/717,070 mailed on Mar. 9, 2012, 9 pages.

(21) Appl. No.: **12/940,020**

* cited by examiner

(22) Filed: **Nov. 4, 2010**

Primary Examiner — Ali Sharifzada

(51) **Int. Cl.**
G06K 7/08 (2006.01)

(74) *Attorney, Agent, or Firm* — Kilpatrick Townsend and Stockton LLP

(52) **U.S. Cl.** **235/449**; 235/435; 235/439; 235/450; 382/312; 382/320

(57) **ABSTRACT**

(58) **Field of Classification Search** 235/435, 235/439, 449, 450; 382/312, 320
See application file for complete search history.

A computer implemented method for processing data stored on a magnetic stripe of a user medium performed by a hand-held computer system includes displaying an alignment GUI on a display of the computer system, wherein the GUI includes a visual alignment mark on the display at a first offset relative to a MEMS magnetic field sensor in the computer system, wherein when a user aligns the user medium to the alignment mark GUI, a portion of a first track of the magnetic stripe is disposed above the MEMS magnetic field sensor, sensing, by the MEMS magnetic field sensor, magnetic data stored on the first track when the user aligns the user medium to the visual alignment mark, and moves the user medium along the visual alignment mark, and determining user data stored on the first track from the magnetic data stored on the first track.

(56) **References Cited**

U.S. PATENT DOCUMENTS

| | | | | |
|--------------|-----|---------|-----------------|---------|
| 4,954,698 | A * | 9/1990 | Yasunaga et al. | 235/454 |
| 5,173,597 | A * | 12/1992 | Anglin | 235/483 |
| 6,076,731 | A * | 6/2000 | Terrell | 235/454 |
| 6,480,699 | B1 | 11/2002 | Lovoi | |
| 7,454,705 | B2 | 11/2008 | Cadez et al. | |
| 7,708,189 | B1* | 5/2010 | Cipriano | 235/375 |
| 8,011,577 | B2 | 9/2011 | Mullen et al. | |
| 8,016,191 | B2 | 9/2011 | Bonalle et al. | |
| 2002/0072163 | A1 | 6/2002 | Wong et al. | |
| 2002/0134837 | A1* | 9/2002 | Kishon | 235/449 |
| 2004/0104268 | A1* | 6/2004 | Bailey | 235/439 |

20 Claims, 7 Drawing Sheets

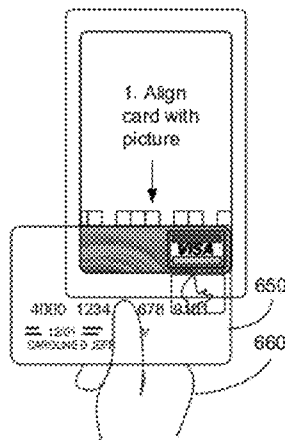

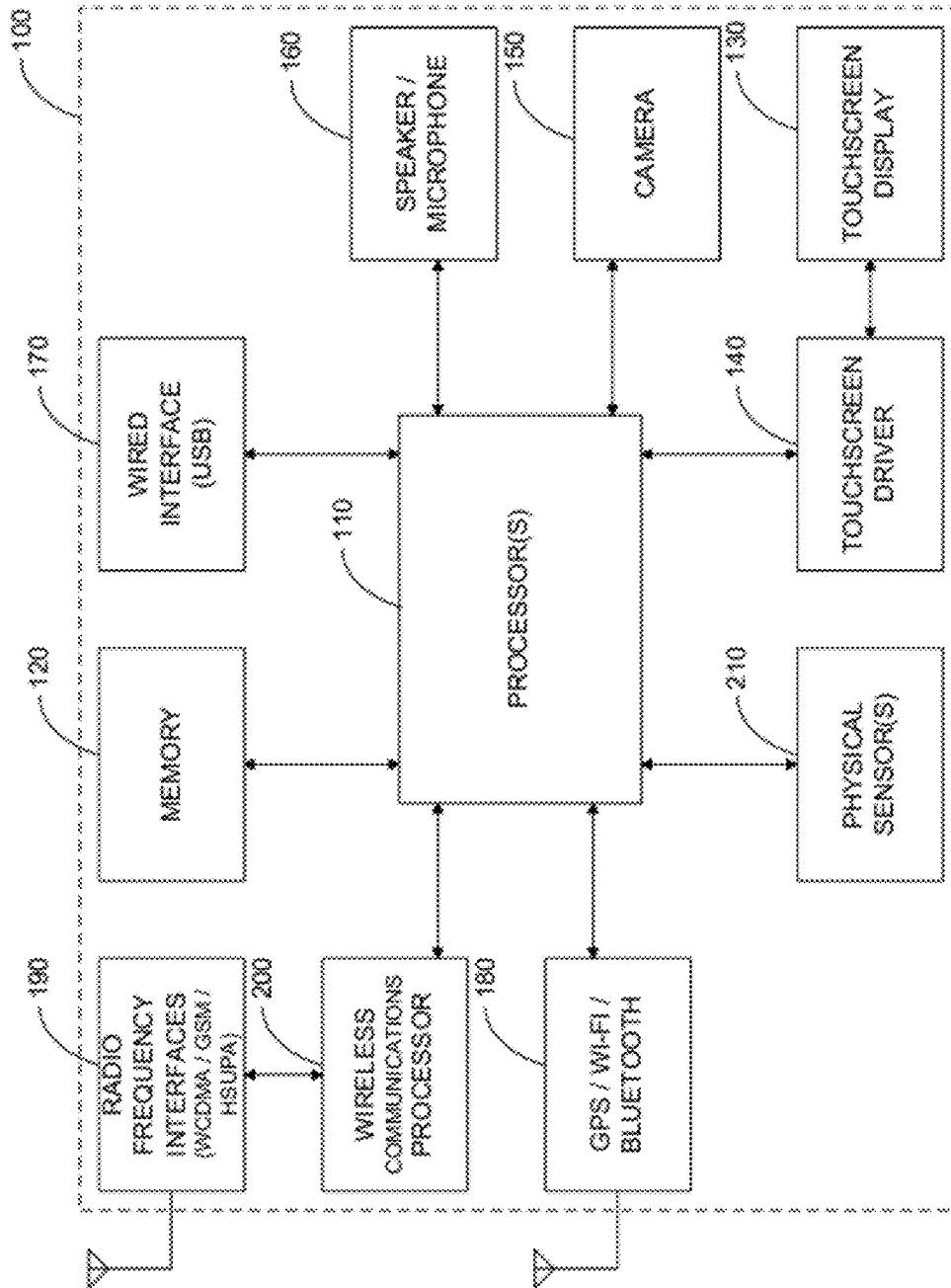

FIG. 1

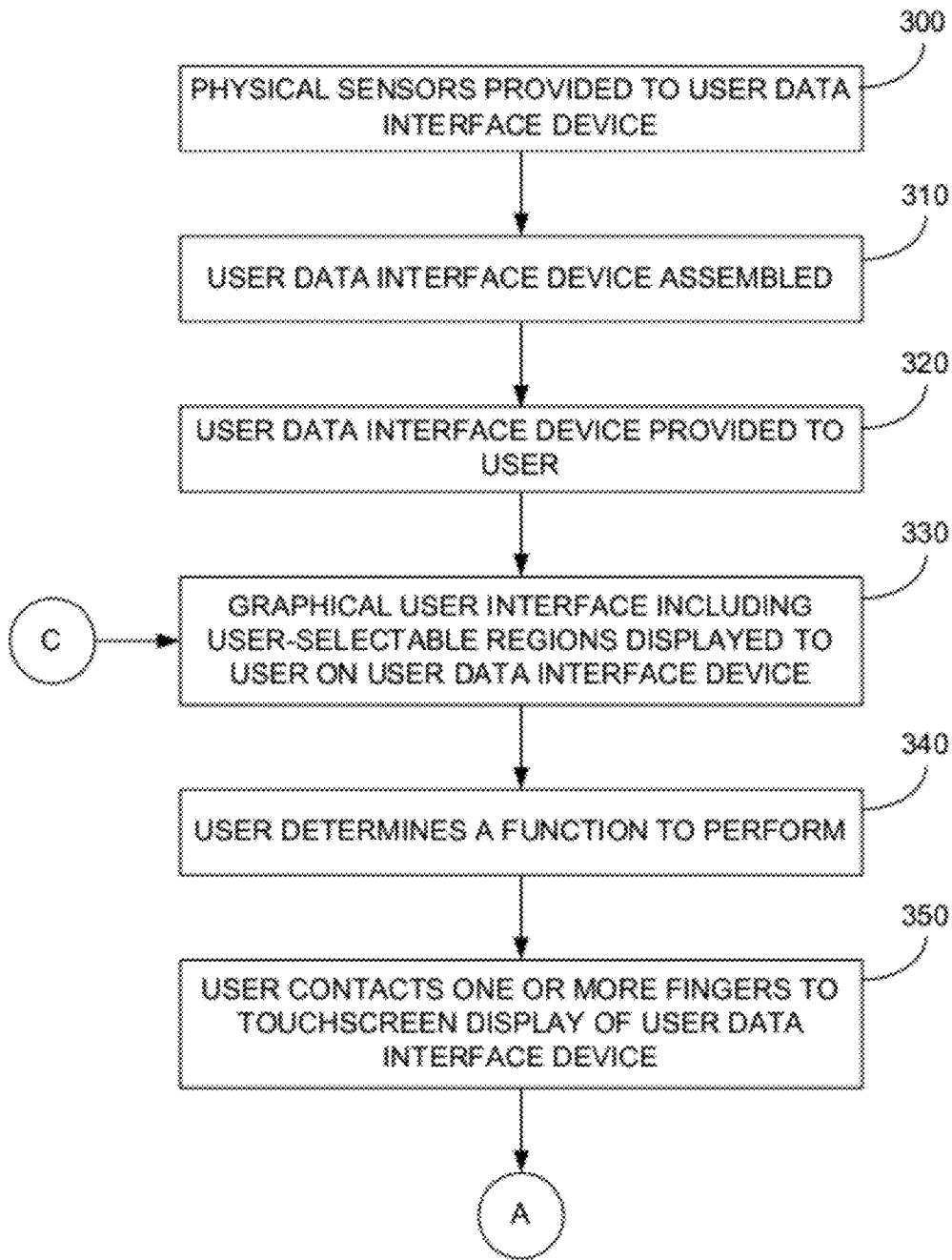

FIG. 2A

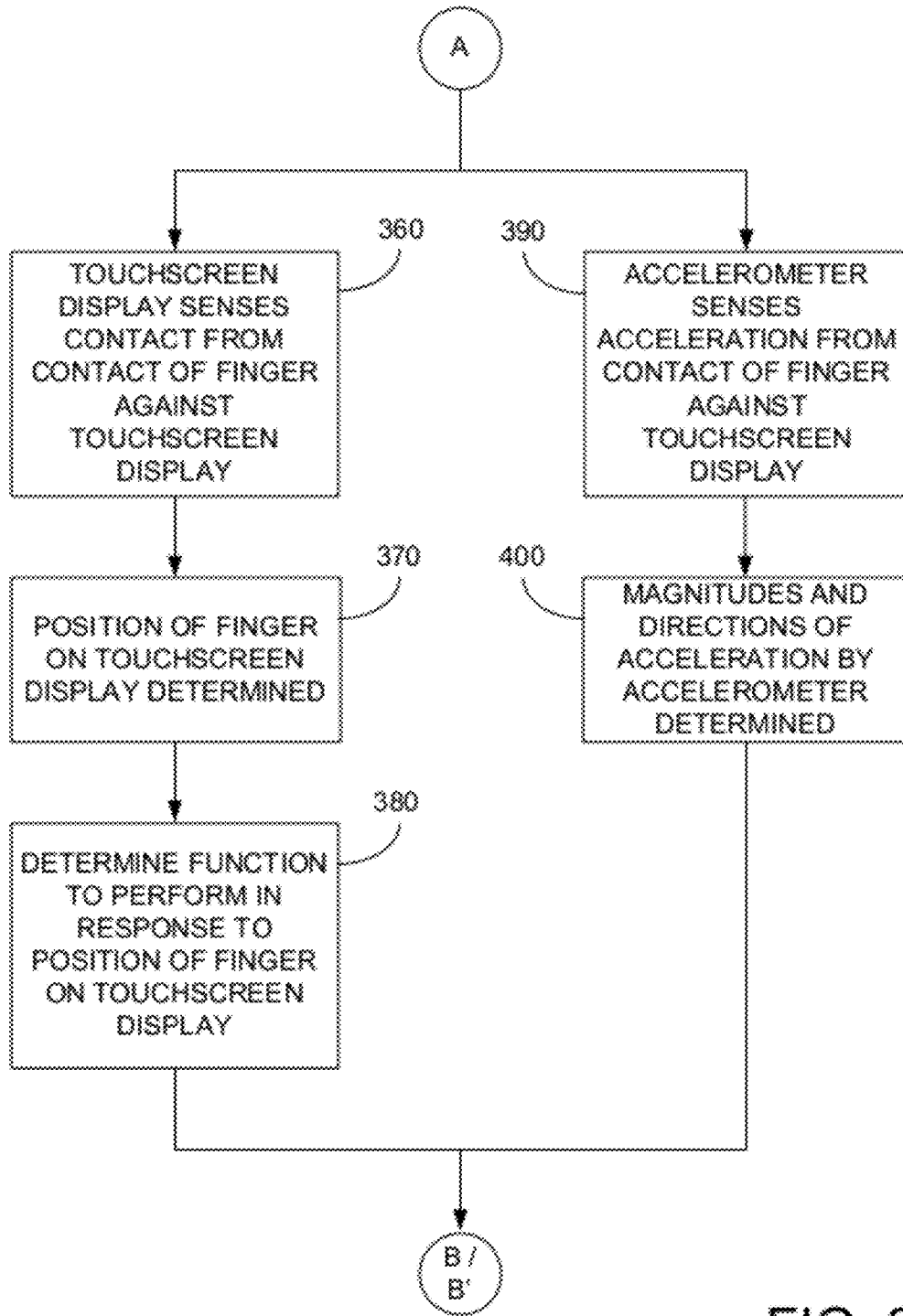

FIG. 2B

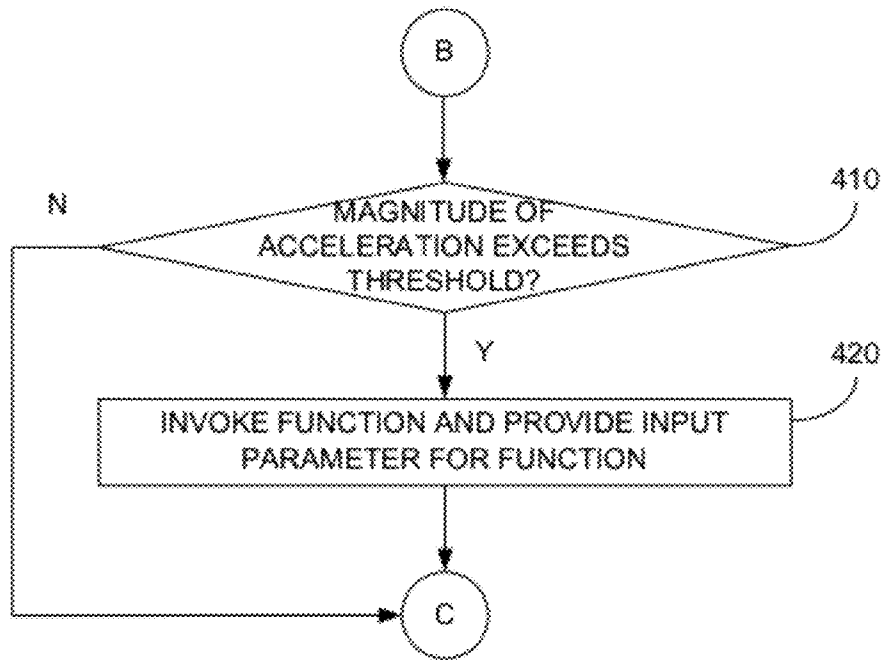

FIG. 2C

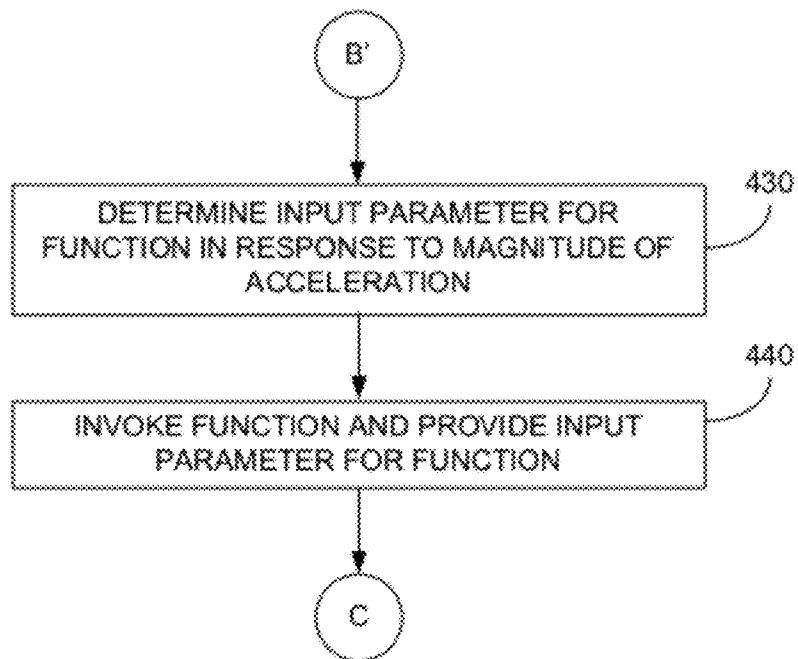

FIG. 2D

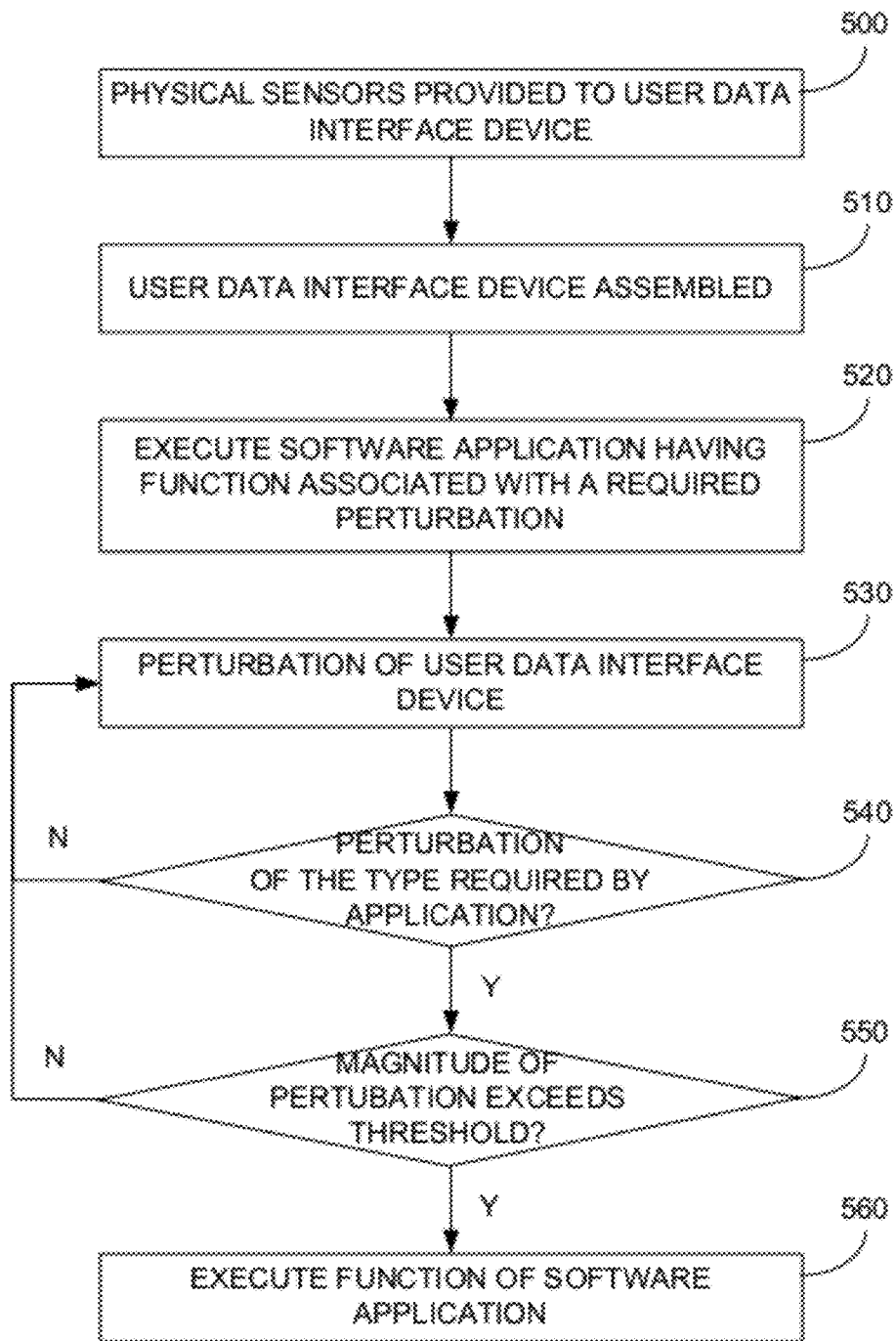

FIG. 3

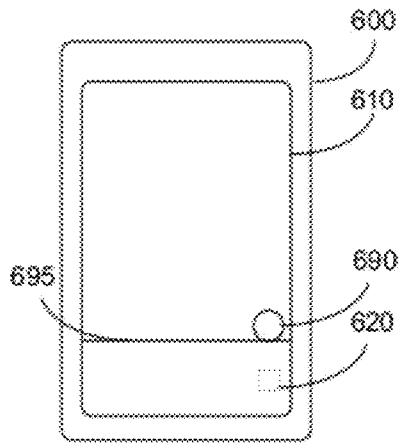

FIG. 4A

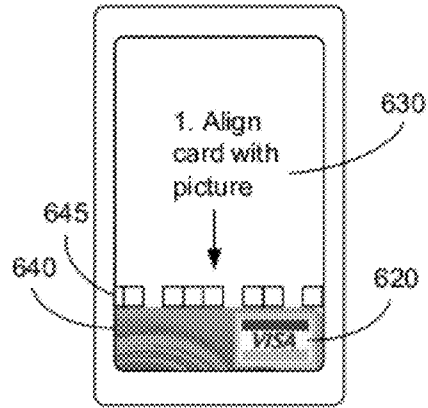

FIG. 4B

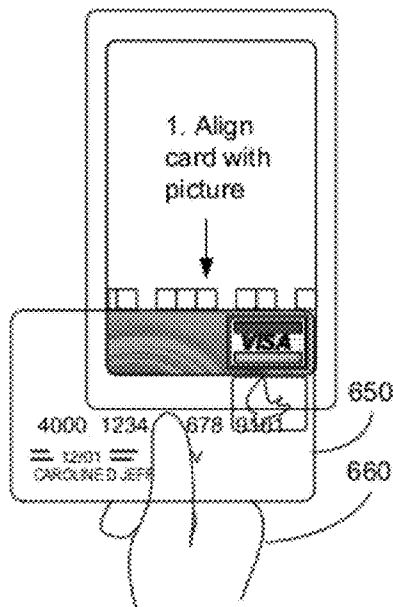

FIG. 4C

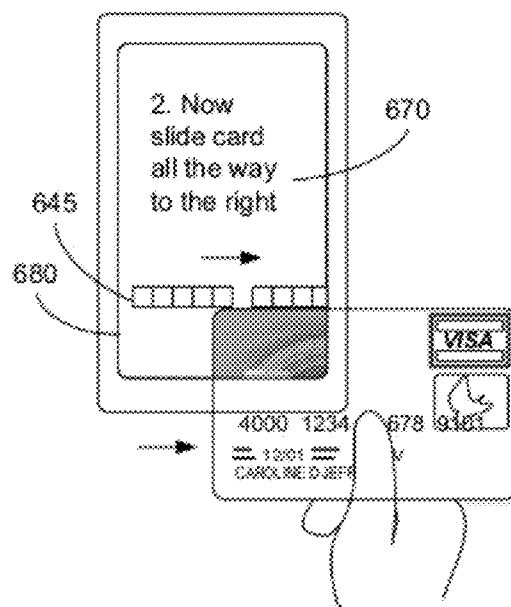

FIG. 4D

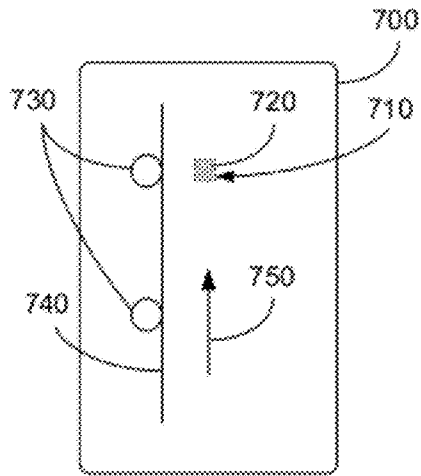

FIG. 5A

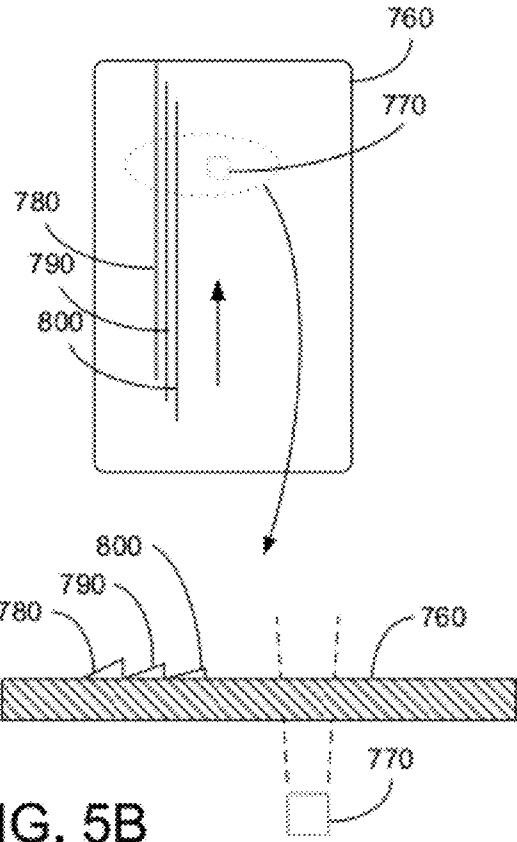

FIG. 5B

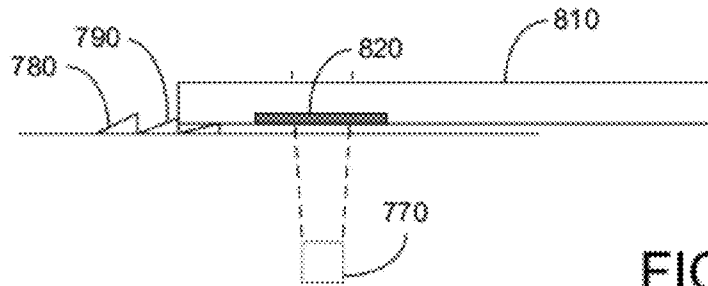

FIG. 5C

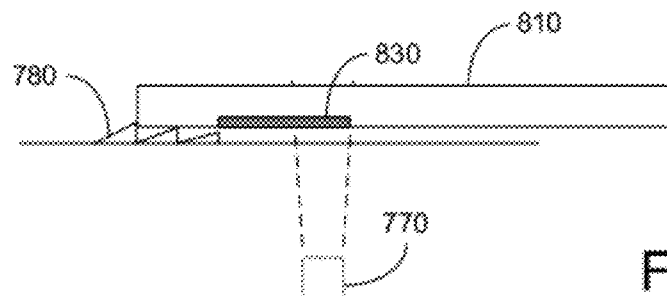

FIG. 5D

**METHODS AND APPARATUS FOR
FACILITATING CAPTURE OF MAGNETIC
CREDIT CARD DATA ON A HAND HELD
DEVICE**

CROSS-REFERENCES TO RELATED
APPLICATIONS

The present application relates to and incorporates by reference, for all purposes, the following pending patent applications: U.S. patent application Ser. No. 12/490,067, filed Jun. 23, 2009, U.S. patent application Ser. No. 12/717,070, filed Mar. 3, 2009, and U.S. patent application Ser. No. 12/787,368, filed May 25, 2010. The present invention also incorporates by reference, for all purposes, the following pending patent applications related to magnetic field sensors: U.S. patent application Ser. No. 12/859,631, filed Aug. 19, 2010, U.S. Pat. App. No. 61/347,805, filed May 24, 2010, and U.S. Pat. App. No. 61/348,387, filed May 26, 2010.

The present application is also related to concurrently filed U.S. patent application Ser. No. 12/940,023, U.S. patent application Ser. No. 12/940,025, and U.S. patent application Ser. No. 12/940,026, all of which are commonly owned and incorporated by reference for all purposes.

BACKGROUND OF THE INVENTION

Embodiments of the present invention relate to touch screen devices. More specifically, the present invention relates to touch screen devices capable of sensing the force of a touch and methods of use thereof.

The use of touch screen devices and touch user interfaces are now quite common place for consumers: from the signature machine in the checkout isle, to automatic teller machines at banks, to ticketing kiosks at airports, and the like. Touch screen capability is also now quite common in hand-held devices: from the Palm Pilot, to the Google Nexus One, to the Apple iPad, and the like.

Touch capability has typically been enabled for many touch screen devices through the incorporation and use of a resistive sensor network. These sensor networks can sense when a single finger of the user touches the display, or when the user uses a stylus to touch the display.

Drawbacks to touch screen devices incorporating resistive-based sensors, determined by the inventor, include that if a user inadvertently touches two locations on the touch screen at the same time, the location reported by the touch screen is often incorrect. As such devices typically only support detecting one finger at a time, for example, if two fingers touch the screen, the reported touch location may be between the two fingers. Another drawback includes that the user has to press down with some force on the touch screen before the touch screen can detect the user touch.

Newer capacitive-based touch screen displays are now more commonly used and address some of the short comings of a resistive-based sensor network. As an example, capacitive-based touch screens can sense the individual locations of fingers when the user touches the display with more than one finger. Accordingly, these devices are often termed "multi-touch" displays. As another example, capacitive-based touch screens do not require the user to press-down upon the touch screen before the finger is sensed.

Drawbacks to the use of capacitive-based touch screens, determined by the inventor, include that even if a user inadvertently brushes her finger across the touch screen, that accidental swipe may still be sensed as a user input. This is particularly frustrating, for example, when a user is trying to

touch-type using a virtual keyboard to input text. In such cases, as the user hovers her fingers over the home row of the virtual keyboard, often her little finger, middle finger, or the like may accidentally touch the surface of the display. These touches are then incorrectly sensed as presses of the virtual keys causing typographical errors.

Although many touch screen devices include automatic spelling/prediction software to attempt to reduce the effect of typographic errors, in many instances the predicted word is not the word the user wants. Accordingly, the user must constantly watch the touch screen display to monitor the automatic predictions and to select the correct word. These types of interruptions greatly interfere with the text-entry efficiency provided by the user's ability to touch-type.

Additional drawbacks determined by the inventor of resistive and capacitive based touch screen include that the sensed touches are typically binary in nature, i.e. either the finger is not touching or the finger is touching. These types of devices cannot sense the force with which a user touches the touch screen display. From a user point of view, these touch screen devices also do not provide a user with any sensation of pressing a button or key, i.e. they provide no tactile feedback.

One type of touch screen display used by Research In Motion (RIM) to provide the user with tactile feedback was used in the Blackberry Storm series of devices. In these products, one or more micro sensors were placed under the capacitive-based touch screen display. In operation, when the user wanted to make an on-screen selection, the user would press the touch screen display. The touch screen display would then deflect (by about a millimeter) and cause one of the micro sensors to physically click or switch. The physical click would thus provide the user with tactile confirmation of the button press.

Drawbacks to such approaches, determined by the inventor, include that such devices were limited to the physical performance of the micro sensors. For example, a user could not type very quickly with such an approach because the user had to pause between key presses to wait until the micro sensors could fully reset before she could press the next key. Further, if the user placed two or more fingers on the touch screen at the same time she depressed the touch screen (activating the micro sensor(s)), it would be unclear which touch screen location or finger the user intended.

The inventor of the present application has also noticed that with advances in graphical user interfaces, capacitive touch displays, high resolution displays, high contrast displays, and the like, much emphasis has been put upon the user interacting with the display. In contrast, previously, a number of physical buttons were provided upon devices such as a portable telephone, a PDA, or the like. When the user pressed the physical buttons, one of a number of actions occurred, such as launching an application, making a telephone call, taking a picture, or the like.

Drawbacks to having physical buttons for such devices included that it increased manufacturing and assembly costs, increased the number of components and complexity of the devices, increased the number of potential faulty components (e.g. broken switch, dust), and the like. Other drawbacks included that physical buttons are now often deemed to be undesirable as they decrease the aesthetics of such devices. In light of the above, recent popular devices have a reduced number of physical buttons.

Drawbacks to concentrating upon virtual (soft) buttons on a display, determined by the inventor, include that such devices greatly increase the requirements that the user view a display and that the user must interact with that display to perform basic functions. As merely an example, with popular

devices, it is now virtually impossible for a user to enter a telephone number without requiring a user to look at the display. As another example, it is now common for a user to press a virtual button displayed on a display to initiate taking a photograph, whereas previously a physical button was provided.

From the above, it is desired to have a device with user input capability without the drawbacks described above.

BRIEF SUMMARY OF THE INVENTION

Embodiments of the present invention relate to touch screen devices. More specifically, the present invention relates to touch screen devices capable of sensing the force of a touch and methods of use thereof.

Various embodiments of the present invention disclose a computer system such as a cell phone, internet access device, media player, or the like having a touch screen display and one or more physical sensors. In operation, when a user touches a location on the touch screen display, the function associated with the touched location is determined. The function may be running of an application program, selection of a function within an application program, and the like. In various embodiments, a type and/or magnitude of movement is determined by the one or more physical sensors also in response to the user touching the touch screen display. Based upon the type and/or magnitude of movement or combinations of movements, an input parameter or value may be determined for use by the selected function. Next, the function is initiated and given the input parameter or value.

Other embodiments of the present invention disclose a computer system such as a tablet computer, a smart phone, cell phone, or the like also having a display (e.g. touch screen) and one or more physical sensors. In operation, when a user touches a location on the touch screen display, the function associated with the touched location is again determined. The function may be running of an application program, selection of a function within an application program, and the like. In various embodiments, a type and/or magnitude of movement is determined by the one or more physical sensors also in response to the user touching the touch screen display. The type and/or magnitude of movement is then compared to one or more thresholds for type and/or magnitude of movement. In various embodiments, if the threshold is not exceeded, the function is inhibited, and when the threshold is exceeded (e.g. enough physical impulse), the function is performed.

Other embodiments of the present invention disclose a computer system such as a tablet computer, a smart phone, cell phone, or the like also having a touch screen display and one or more physical sensors. In operation, when a user physically perturbs the computer system, the perturbation will cause the computer system to perform a user-desired action. The perturbation may be a change in physical position or angular orientation of the computer system, a change in air pressure, a change in sensed magnetic field, or the like. Merely as examples, a user tapping upon a case of the computer system (device) (or a surface upon which the computer system is laying upon or may cause the computer system to take a picture; start or stop a timer; answer or disconnect a telephone call; invoke an application (e.g. knock-knocking on a computer system to invoke a VOIP application, a chat application, an IM, or the like); or the like. As other examples, a user positioning a credit card magnetic strip near the computer system may invoke a payment application and/or may cause the computer system to sense the data encoded on the magnetic strip; a sudden change in magnetic field may cause the computer system to shut down; a constant or sudden

change in air pressure may invoke a pressure monitoring program (e.g. a scuba diving log application, a weather application); may cause the computer system to disconnect wireless transceivers and enter an "airplane mode;" or the like.

According to one aspect of the invention, a computer implemented method for processing data stored on a magnetic stripe of a user provided medium performed by a handheld computer system programmed to perform the method is described. One process includes displaying, with a processor disposed within the computer system, a first alignment graphical user interface on a display of the computer system, wherein the first alignment graphical user interface includes a first visual alignment mark, wherein the first alignment mark is positioned on the display relative to a position of a MEMS magnetic field sensor disposed within the computer system at a first offset, wherein when a user aligns the user provided medium to the first alignment mark on the display, a portion of a first track of the magnetic stripe is disposed above the MEMS magnetic field sensor. A method may include sensing, by the MEMS magnetic field sensor, a plurality of magnetic data stored on the first track of the magnetic stripe, in response to the user aligning the user provided medium to the first alignment mark, and moving the user provided medium along the first alignment mark, and determining, with the processor, a plurality of user data stored on the first track of the magnetic stripe in response to the plurality of magnetic data stored on the first track.

According to yet another aspect of the invention, a handheld computer system for processing data stored on a magnetic stripe of a user provided medium is disclosed. One apparatus may include a housing and a tangible memory for storing a plurality of non-transitory executable instructions. A device may include a display disposed within the housing, wherein the display is configured to display a plurality of graphical user interfaces to a user, and a MEMS magnetic field sensor disposed within the housing, wherein the MEMS magnetic field sensor is configured to sense magnetic data stored within a magnetic stripe of the user provided medium. A system may include a processor disposed within the housing and coupled to the tangible memory, the display, and to the MEMS magnetic field sensor, wherein the processor is programmed to perform a plurality of functions by the plurality of non-transitory executable instructions. In various embodiments, the plurality of non-transitory executable instructions may include executable code that programs the processor to display a first alignment graphical user interface on the display, wherein the first alignment graphical user interface includes a first visual alignment mark, wherein the first alignment mark is positioned on the display relative to a position of the MEMS magnetic field sensor at a first offset, wherein when the user aligns the user provided medium to the first alignment mark on the display, a portion of a first track of the magnetic stripe is sensed by the MEMS magnetic field sensor, and executable code that programs the processor to determine a plurality of user data stored on the first track of the magnetic stripe, in response to magnetic data stored within the first track of the magnetic stripe sensed by the MEMS magnetic field sensor when the user moves the user provided medium along the first alignment mark.

Various additional objects, features and advantages of the present invention can be more fully appreciated with reference to the detailed description and accompanying drawings that follow.

BRIEF DESCRIPTION OF THE DRAWINGS

In order to more fully understand the present invention, reference is made to the accompanying drawings. Under-

standing that these drawings are not to be considered limitations in the scope of the invention, the presently described embodiments and the presently understood best mode of the invention are described with additional detail through use of the accompanying drawings in which:

FIG. 1 illustrates a functional block diagram of various embodiments of the present invention;

FIGS. 2A-D illustrate block diagrams of flow processes according to various embodiments of the present invention;

FIG. 3 illustrates a block diagram of flow processes according to various embodiments of the present invention;

FIGS. 4A-D illustrate a process according to various embodiments of the present invention; and

FIGS. 5A-D illustrate a process according to various embodiments of the present invention.

DETAILED DESCRIPTION OF THE INVENTION

FIG. 1 illustrates a functional block diagram of various embodiments of the present invention. In FIG. 1, a computing device 100 typically includes an applications processor 110, memory 120, a touch screen display 130 and driver 140, an image acquisition device 150, audio input/output devices 160, and the like. Additional communications from and to computing device are typically provided by via a wired interface 170, a GPS/Wi-Fi/Bluetooth interface 180, RF interfaces 190 and driver 200, and the like. Also included in various embodiments are physical sensors 210.

In various embodiments, computing device 100 may be a hand-held computing device (e.g. Apple iPad, Apple iTouch, Dell Mini slate, Lenovo Skylight/IdeaPad, Asus EEE series, Microsoft Courier, Notion Ink Genesis, Samsung Galaxy Tab.), a portable telephone (e.g. Apple iPhone, Motorola Droid, Droid X, Google Nexus One, HTC Incredible/EVO 4G, Palm Pre series, Nokia N900), a portable computer (e.g. netbook, laptop), a media player (e.g. Microsoft Zune, Apple iPod), a reading device (e.g. Amazon Kindle, Barnes and Noble Nook), or the like.

Typically, computing device 100 may include one or more processors 110. Such processors 110 may also be termed application processors, and may include a processor core, a video/graphics core, and other cores. Processors 110 may be a processor from Apple (A4), Intel (Atom), NVidia (Tegra 2), Marvell (Armada), Qualcomm (Snapdragon), Samsung, TI (OMAP), or the like. In various embodiments, the processor core may be an Intel processor, an ARM Holdings processor such as the Cortex-A, -M, -R or ARM series processors, or the like. Further, in various embodiments, the video/graphics core may be an Imagination Technologies processor PowerVR -SGX, -MBX, -VGX graphics, an Nvidia graphics processor (e.g. GeForce), or the like. Other processing capability may include audio processors, interface controllers, and the like. It is contemplated that other existing and/or later-developed processors may be used in various embodiments of the present invention.

In various embodiments, memory 120 may include different types of memory (including memory controllers), such as flash memory (e.g. NOR, NAND), pseudo SRAM, DDR SDRAM, or the like. Memory 120 may be fixed within computing device 100 or removable (e.g. SD, SDHC, MMC, MINI SD, MICRO SD, CF, SIM). The above are examples of computer readable tangible media that may be used to store embodiments of the present invention, such as computer-executable software code (e.g. firmware, application programs), application data, operating system data or the like. It is contemplated that other existing and/or later-developed

memory and memory technology may be used in various embodiments of the present invention.

In various embodiments, touch screen display 130 and driver 140 may be based upon a variety of later-developed or current touch screen technology including resistive displays, capacitive displays, optical sensor displays, electromagnetic resonance, or the like. Additionally, touch screen display 130 may include single touch or multiple-touch sensing capability. Any later-developed or conventional output display technology may be used for the output display, such as TFT-LCD, OLED, Plasma, trans-reflective (Pixel Qi), electronic ink (e.g. electrophoretic, electrowetting, interferometric modulating). In various embodiments, the resolution of such displays and the resolution of such touch sensors may be set based upon engineering or non-engineering factors (e.g. sales, marketing). In some embodiments of the present invention, a display output port, such as an HDMI-based port or DVI-based port may also be included.

In some embodiments of the present invention, image capture device 150 may include a sensor, lens and the like. The sensor may be based upon any later-developed or conventional sensor technology, such as CMOS, CCD, or the like. In various embodiments of the present invention, image recognition software programs are provided to process the image data. For example, such software may provide functionality such as: facial recognition, head tracking, camera parameter control, or the like.

In various embodiments, audio input/output 160 may include conventional microphone(s)/speakers. In some embodiments of the present invention, three-wire or four-wire audio connector ports are included to enable the user to use an external audio device such as external speakers, headphones or combination headphone/microphones. In various embodiments, voice processing and/or recognition software may be provided to applications processor 110 to enable the user to operate computing device 100 by stating voice commands. Additionally, a speech engine may be provided in various embodiments to enable computing device 100 to provide audio status messages, audio response messages, or the like.

In various embodiments, wired interface 170 may be used to provide data transfers between computing device 100 and an external source, such as a computer, a remote server, a storage network, another computing device 100, or the like. Such data may include application data, operating system data, firmware, or the like. Embodiments may include any later-developed or conventional physical interface/protocol, such as: USB 2.0, 3.0, micro USB, mini USB, Firewire, Apple iPod connector, Ethernet, POTS, or the like. Additionally, software that enables communications over such networks is typically provided.

In various embodiments, a wireless interface 180 may also be provided to provide wireless data transfers between computing device 100 and external sources, such as computers, storage networks, headphones, microphones, cameras, or the like. As illustrated in FIG. 1, wireless protocols may include Wi-Fi (e.g. IEEE 802.11a/b/g/n, WiMax), Bluetooth, IR and the like.

GPS receiving capability may also be included in various embodiments of the present invention, however is not required. As illustrated in FIG. 1, GPS functionality is included as part of wireless interface 180 merely for sake of convenience, although in implementation, such functionality is currently performed by circuitry that is distinct from the Wi-Fi circuitry and distinct from the Bluetooth circuitry.

Additional wireless communications may be provided via RF interfaces 190 and drivers 200 in various embodiments. In

various embodiments, RF interfaces **190** may support any future-developed or conventional radio frequency communications protocol, such as CDMA-based protocols (e.g. WCDMA), GSM-based protocols, HSPA-based protocols, or the like. In the embodiments illustrated, driver **200** is illustrated as being distinct from applications processor **110**. However, in some embodiments, these functionality are provided upon a single IC package, for example the Marvel PXA330 processor, and the like. It is contemplated that some embodiments of computing device **100** need not include the RF functionality provided by RF interface **190** and driver **200**.

FIG. **1** also illustrates computing device **100** to include physical sensors **210**. In various embodiments of the present invention, physical sensors **210** are multi-axis Micro-Electro-Mechanical Systems (MEMS) based devices being developed by M-cube, the assignee of the present patent application. Physical sensors **210** developed by M-cube currently include very low power three-axis sensors (linear, gyro or magnetic); ultra-low jitter three-axis sensors (linear, gyro or magnetic); low cost six-axis motion sensor (combination of linear, gyro, and/or magnetic); ten-axis sensors (linear, gyro, magnetic, pressure); and various combinations thereof. As described in the patent applications referenced above, various embodiments of physical sensors **210** are manufactured using a foundry-compatible process. As explained in such applications, because the process for manufacturing such physical sensors can be performed on a standard CMOS fabrication facility, it is expected that there will be a broader adoption of such components into computing device **100**. In other embodiments of the present invention, conventional physical sensors **210** from Bosch, STMicroelectronics, Analog Devices, Kionix or the like may be used.

In various embodiments, any number of future developed or current operating systems may be supported, such as iPhone OS (e.g. iOS), WindowsMobile (e.g. 7), Google Android (e.g. 2.2), Symbian, or the like. In various embodiments of the present invention, the operating system may be a multi-threaded multi-tasking operating system. Accordingly, inputs and/or outputs from and to touch screen display **130** and driver **140** and inputs/or outputs to physical sensors **210** may be processed in parallel processing threads. In other embodiments, such events or outputs may be processed serially, or the like. Inputs and outputs from other functional blocks may also be processed in parallel or serially in other embodiments of the present invention, such as image acquisition device **150** and physical sensors **210**.

FIG. **1** is representative of one computing device **100** capable of embodying the present invention. It will be readily apparent to one of ordinary skill in the art that many other hardware and software configurations are suitable for use with the present invention. Embodiments of the present invention may include at least some but need not include all of the functional blocks illustrated in FIG. **1**. For example, in various embodiments, computing device **100** may lack image acquisition unit **150**, or RF interface **190** and/or driver **200**, or GPS capability, or the like. Additional functions may also be added to various embodiments of computing device **100**, such as a physical keyboard, an additional image acquisition device, a trackball or trackpad, a joystick, or the like. Further, it should be understood that multiple functional blocks may be embodied into a single physical package or device, and various functional blocks may be divided and be performed among separate physical packages or devices.

FIGS. **2A-D** illustrate block diagrams of flow processes according to various embodiments of the present invention.

For illustrative purposes only, references to elements in FIG. **1** are provided in the discussion below merely for the sake of convenience.

In various embodiments of the present invention, physical sensors **210** are provided as part of a computing device **100**, step **300**. For example, physical sensors **210** developed by the assignee of the present patent application are provided to an assembly entity to form computing device **100**. Computing device **100** is then assembled, step **310** and provided for the user, step **320**. As described above, in various embodiments, computing device **100** may be a cell-phone, an internet access device, a tablet computer, a personal media player/viewer, or the like running an appropriate operating system.

In ordinary use of such a device, computing device **100** (via the operating system) may display any number of graphical user interfaces including user-selectable regions on touch screen display **130**, step **320**. These user-selectable regions may include radio buttons, sliders, selection buttons, text entry regions and the like. Further, these soft buttons may be associated with application software functions, operating system functions, data management functions, telephony functions, audio processing functions, image processing functions, or the like.

Subsequently, the user determines a function she wishes computing device **100** to perform after viewing the graphical user interface, step **340**. In various embodiments, the user then touches or contacts a portion of touch screen display **130** corresponding to the user-selectable region, step **350**.

Next, in various embodiments of the present invention, the following processes can be performed in parallel by different processing threads, serially by one or more processes, or independently in separate processing threads.

In FIG. **2B**, touch screen display **130** senses the user contact in step **360**. As described above, in various embodiments, touch screen display **130** may perform this function via the use of resistive sensors, capacitive sensors, or the like. In response to the physical sensor data, the user-selectable region within the GUI is determined, step **370**. Next, in various embodiments, computing device **100** then determines one or more functions associated with the user-selectable region, step **380**.

In various embodiments of the present invention, it is contemplated that when a user contacts her finger on touch screen display **130** in step **350**, computing device **100** (physical sensors **210**) will be physically perturbed, step **390**. For example, when the user touches touch screen display **130**, computing device **100** (physical sensors **210**) will be subject to a force (e.g. a change in sensed physical state, a physical perturbation). In various embodiments, this physical change causes physical sensors **210** to sense a change in spatial location (sensed by an accelerometer), causes physical sensors **210** to sense a change its tilt or orientation (sensed by a gyroscope), or the like. For sake of convenience, FIG. **2A** merely references use of an accelerometer. In other embodiments, this change causes physical sensors **210** to sense a change in a magnetic field, sense a change in GPS coordinates, sense a change in temperature or air pressure, or the like.

Next, in various embodiments in response to the perturbations of the computing device **100**/physical sensors **210**, magnitudes and/or directions of the changes are determined in step **400**. As described in the above-referenced patent applications, the CMOS foundry-compatible MEMS physical sensor embodiments of the present invention provide a higher level of sensitivity and lower level of noise for such measurements than is currently available.

In various embodiments of the present invention, the process may then proceed to FIG. 2C or 2D.

In the example illustrated in FIG. 2C, a determination is then made as to whether the type, magnitude and/or direction of the sensed physical perturbations exceed a predetermined threshold, step 410. In various embodiments, the type of sensed perturbations and the threshold may be predetermined by the operating system, may be set by the user during, for example, a setup phase, may be specified by the application of

As various examples, the threshold may be an acceleration in a $-z$ -direction (away from a touch screen display) of 0.1 g, an acceleration in a $-z$ -direction of 0.05 g followed by an acceleration in the $+z$ -direction of 0.03 g; an acceleration of 0.1 g in the $-z$ -direction and accelerations of 0.03 g in the x and y directions; a tilt of 0.5 degrees in a first axis rotation at the same time as a tilt of 1 degree in a second axis of rotation; a tilt of 0.2 degrees in a first axis followed by a tilt of -0.3 degrees in the first axis; a increase in magnetic field by 10 gauss; an increase in atmospheric pressure of 10 mm Hg for 0.25 seconds; and the like. In light of the present patent disclosure, one of ordinary skill in the art will recognize many different thresholds based upon permutations of acceleration, tilts, magnetic fields, pressure, GPS coordinates, time, and the like, that are within the scope of embodiments of the present invention.

In various embodiments, if the threshold is exceeded, the function determined in step 380 is performed, step 420; if not, the process returns to step 330. Embodiments may be applied to any number of different functions, for example, a virtual telephone keypad. In typical situations, a user may inadvertently make a telephone call when the cell phone is in her pocket and she reaches for her keys. As her fingers brush against the virtual keypad, the telephone may interpret these as user selections for a telephone number to call. In various embodiments, inadvertent calls may be avoided, if it is required that the physical sensors detect an acceleration (e.g. 0.1 g) primarily in the $-z$ direction at about the same time the user touches the virtual keyboard keys. When in her pocket, when the fingers brush or knock against the key pad, the physical sensors may detect an acceleration of 0.05 g in the $-z$ direction, 0.02 in the x direction and 0.05 in the y direction, then, the user touch may be ignored. Accordingly, the execution of unintended user functions on a computing device may be reduced.

In additional embodiments of the present invention, the process of FIG. 2B may proceed to FIG. 2D. In these embodiments a determination is then made as to a value for an input parameter based upon the type, magnitude and/or direction of the sensed physical perturbations, step 430. In various embodiments, a relationship between the type of sensed perturbations and the input parameter may be predetermined by the operating system, may be set by the user during, for example, a setup phase, may be specified by the application of function or the like.

Similar to the embodiment illustrated in FIG. 2C, a number of different thresholds may be used and mapped to different values for the input parameter. In various examples, an acceleration in a $-z$ -direction (away from a touch screen display) of 0.1 g may map to an input value of "1," 0.2 g may map to "2," 0.3 g may map to "3," or the like; an acceleration in only a $-z$ direction of 0.01 g may map to an input value of "256," an acceleration of 0.01 g in the $-z$ direction and 0.05 g in the x -direction may map to an input value of "512;" a clockwise roll of 0.1 degrees may map to an input value of "increase," a counter clock-wise roll of 0.1 degrees may map to an input value of "decrease," or the like.

In response to the value for the input parameter determined, in step 440, the function may be performed using this value. Embodiments may be applied to any number of different functions, for example, a painting program. In such cases, a harder tap may be associated with a larger paint spot upon a canvas, a softer tap may be associated with a smaller spot upon a canvas, and the like. In other embodiments, other types of parameters may also be adjusted based upon sensed physical change such as: position of graphic elements, brightness, contrast, gamma, sharpness, saturation, filter, and the like. As another example, a flick of a finger at a first velocity with a low impact may be associated moving a series of images at a slower rate, a flick of a finger at the first velocity with a higher impact may be associated moving a series of images at a faster rate. In other embodiments, other types of parameters may also be adjusted, such as: rate of acceleration, rate of rotation, rate of zoom, rate of pan, and the like. As another example, the type or magnitude of sensed physical change may control a volume level, a microphone sensitivity level, a bass level, a treble level, or the like. Accordingly, the execution of user functions may have different input parameters of values based upon sensed physical changes.

FIG. 3 illustrates a block diagram of flow processes according to various embodiments of the present invention. For illustrative purposes only, reference to elements in FIG. 1 may be provided in the discussion below merely for the sake of convenience.

In various embodiments of the present invention, physical sensors 210 are provided as part of a computing device 100, step 500. For example, physical sensors 210 developed by the assignee of the present patent application are provided to an assembly entity to form computing device 100. Computing device 100 is then assembled, step 510, and provided for the user. As described above, in various embodiments, computing device 100 may be a cell-phone, internet access device, a tablet computer, a personal media player/viewer, or the like running an appropriate operating system along with software applications. These steps may be performed at device manufacturing time whereas the following steps may be performed by a user of the device, or the like.

Next, a user may run or execute a software application upon computing device 100, step 520. In various embodiments, the software application may be an operating system, a program, or the like. In such software, a user input or triggering event is required to invoke a function on computing device 100. As merely an example, a function may be taking a picture, answering or terminating a phone call; initiating a VOIP application, chat program, IM, or the like; initiating a data logging program; or the like. In various embodiments, the user may be prompted to perturb computing device 100 to invoke the function. For example, an output audio message may prompt the user, such as, "tap the phone anywhere to take a picture;" a display image may prompt the user, such as a sequential display of lights in a drag strip "Christmas tree" sequence; and the like.

In various embodiments, computing device 100 is perturbed, step 530. In some examples, the user may directly perturb computing device 100, for example, the user may physically displace, accelerate, rotate and/or move computing device 100 itself (e.g. tapping on the interface device); the user may perturb computing device 100 indirectly (e.g. tapping on a table upon which the interface device is resting); or the like. In other examples, the user may indirectly cause the perturbation, for example, a computing device 100 and a magnetic source are moved towards or away from each other, the air pressure may decrease as the user flies in an airplane or as the weather changes, or the like.

In various embodiments, a type and magnitude of the perturbation are determined by the respective sensors, typically in parallel. For example, an acceleration in the x, y or z axis may be determined by x, y, and z axis accelerometers, a tilt, pan, or roll may be determined by x, y and z rotation sensors, a change in pressure may be determined by a pressure sensor, a change in magnetic field in may be determined in x, y and z axis by separate magnetic sensors, and the like. As discussed above, various embodiments of the present invention may be embodied as a three-axis, six-axis, nine-axis, ten-axis or the like MEMS device currently being developed by the assignee of the present patent application.

In response to the perturbations, computing device **100** determines whether the perturbation are of the type expected/required by the software application, step **540**. For example, if computing device **100** is expecting an acceleration in the z-axis, a change in magnetic field may not be deemed to be the proper type of perturbation; if computing device **100** is expecting a change in GPS coordinates, a rotation may not be deemed to be the proper type of perturbation, or the like. In various embodiments, if the perturbation is the desired type, the process continues in step **550**, otherwise, the perturbation may be ignored.

In some embodiments of the present invention, the magnitudes of the perturbations may be compared to one or more thresholds, step **550**. This step is similar to that described in step **410**, above. More specifically, in various embodiments, it may be desirable that the magnitudes of the perturbations be sufficient to reduce the chance of accidental or unintended user input. For example, in one application, a user can knock upon a table to answer call on a cell phone resting upon the table. In such an application, it may be desirable that a firm knock be sensed, before the phone is answered, otherwise, mere shuffling of papers may cause the call to be answered. As other examples, in some embodiments, a change in sensed magnetic field may be small enough to be considered merely noise, thus such changes may be ignored; a change in sensed pressure differential may be too small to be considered a valid pressure differential; or the like.

As another example, in one application, a user taps on the surface of a hand-held device (e.g. edge, back plate, etc.) to have the hand-held device take a picture. In such an application, without such a threshold, as the user is fumbling the hand-held device and moving the device to a proper photographic position, the hand-held device may sense such changes in positions, and the like, as the user command to take a picture. Accordingly, without a properly set threshold, pictures may be taken at the wrong times.

In various embodiments, if the magnitude of the perturbation exceeds the threshold, the desired function may be performed, step **560**. In light of the present patent disclosure, one of ordinary skill in the art will recognize many different types of applications may be performed within embodiments of the present invention.

Merely by example, one application may be recording acceleration data in three-dimensions with respect to time. In such an example, the user may invoke the software application on the computing device; however, the actual recording of the data is initiated in step **560**, only after a sufficient change in acceleration is sensed. Such an application may be useful for data logging purposes for a vehicle (e.g. a black box), may be useful for data logging for sports activities (e.g. monitoring movement of a golf club, fishing rod, racquet), may be useful for data logging of freight (e.g. monitoring how roughly freight is handled), or the like. In various examples, other types of perturbations other than the triggering perturbation may also be logged, in the embodiments above. For

example, for data logging of sports activities, the rotation in three axes of a golf club may also be recorded in addition to the linear acceleration of the golf club, in three-dimensions.

As another example, one application may be recording magnetic data stored on a magnetic storage media (e.g. a magnetic stripe (e.g. a bank card, credit card); magnetic ink (e.g. currency, commercial or consumer paper, negotiable instruments); or the like. Representative examples include a hand-held device, such as a phone, applications device (e.g. Apple iPad) or the like, including one or more magnetic field sensors, as disclosed in the above-mentioned patent application. In some embodiments of the present invention, the sensitivity of such magnetic sensors may range from approximately: 0.8 mV/V/Oe to 1 mV/V/Oe to approximately 1.2 mV/V/Oe, or the like; and the field range of such magnetic sensors may be adjusted by gain and may be within the range from approximately, +/-1 Oe, to +/-2 Oe, to +/-4 Oe, to +/-8 Oe to +/-12 Oe, or the like. In such devices, a software application running on the computing device may be designed to read magnetic field data external to the device, using the included magnetic sensors. In various examples, the application may monitor the data from the magnetic sensors when the magnetic stripe of a credit card, or the like, is moved (e.g. slowly) over the device. In other embodiments, the device may be moved relative to the credit card, or the like.

In various embodiments, the magnetic sensors can separately read any of the three or more tracks recorded on typical credit card magnetic stripes, drivers licenses, or the like, depending upon the orientation of the magnetic stripes relative to the magnetic sensors. Such embodiments may include magnetic shielding to help isolate track data. In various embodiments, the encoded data stored on any or all of the tracks can be individually sensed or read. In various embodiments, the magnetic sensors may be configured such that the magnetic data on a credit card, or the like may be sensed on the rear portion of a device, e.g. through the casing; or the magnetic sensors may be configured to sense magnetic data on the front portion of a device, e.g. over the display. For the former example, a line, a black mark, a circle or the like may be a physical feature or a graphic feature provided on the rear portion of the device to help the user align the magnetic tracks to the magnetic sensors. Examples of the magnetic sensor being on the front portion of a device and the magnetic sensor being on the back portion of a device are illustrated below.

FIGS. **4A-D** illustrate a process according to various embodiments of the present invention. FIG. **4A** illustrates a computing device **600**, having a display **610** and a magnetic sensor **620**. Similar to embodiments described above, computing device **600** may be embodied as a hand-held device, a cell-phone, an applications platform, or the like. Further, magnetic sensor **620** may be a magnetic sensing element that is embedded into computing device **600** and configured to sense magnetic fields above display **610**, for example. In various embodiments, magnetic sensor **620** may be a MEMS based magnetic sensor. Further, in various embodiments, magnetic sensor **620** may be a MEMS based magnetic sensor having high sensitivity, high field range, and low-noise, such as a MEMS based magnetic sensor described in the patent application incorporated by reference above.

In FIG. **4B**, a processor of computing device **600** is programmed to run an application program that provides a graphical user interface (GUI) **630** on display **610**. In various embodiments, GUI **630** may include textual information, as well as graphical images **640**. In the example illustrated in FIG. **4A**, GUI **630** instructs the user to hold up their magnetic storage media, e.g. credit card, adjacent to display **610** as shown by graphical image **640**. In various embodiments,

graphical image 640 serves as a visual guide to the user for aligning the magnetic storage media relative to magnetic sensor 620 for the subsequent steps. In various embodiments, graphical image 640 may also include graphical image 645 that helps the user maintain alignment of a magnetic storage media relative to magnetic sensor 620.

As illustrated in FIG. 4C, a user 660 holds up magnetic storage media 650 according to the instructions in GUI 610. In various embodiments, when the magnetic storage media is placed in such an orientation or alignment, magnetic sensor 620 may be aligned to a particular magnetic track of magnetic storage media 650. For example, based upon graphical image 640, magnetic sensor 620 may be aligned to any of the three magnetic tracks found on typical credit cards, for example. As one example, an application may visually instruct the user 660 to position magnetic storage media 650 such that magnetic sensor 620 is aligned to track one, then the application may visually instruct the user 660 to position magnetic storage media 650 such that magnetic sensor 620 is aligned to track two, or the like.

In various embodiments, when magnetic sensor 620 senses magnetic media from magnetic storage media 650 positioned above magnetic sensor 620, the application program progresses to the next state.

As illustrated in FIG. 4D, in various embodiments, the processor running the application program provides GUI 670. In various embodiments, GUI 670 may include textual information, as well as graphical and/or moving images 680. In the example illustrated in FIG. 4D, GUI 670 instructs the user to carefully move magnetic storage media 650 along display 610. As illustrated, graphical image 645 may along with graphical image 640 to provide user 660 with visual feedback.

By doing this, magnetic storage media 650 is passed across magnetic sensor 620, and data stored on the appropriate track is read by magnetic storage media 650. In various embodiments, the read data is used by the application program. For example, in various embodiments, if magnetic storage media 650 is a credit card, the credit card number, name, and the like can be read; if magnetic storage media 650 is a license, a name, physical characteristics, address, and the like can be read; and the like. The application may then provide the data to a remote server for storage or for further processing, for example, providing the credit card number and expiration date to a web-based retailer, or the like; providing a drivers license number to law enforcement agencies; or the like.

In other embodiments of the present invention, a user may be instructed to place their finger, thumbnail, another credit card or the like along the display to aid in alignment of the magnetic sensors relative to the magnetic track, or the like. For example, the user may be instructed to place a finger of their other hand on location 690 to keep the top edge of magnetic storage media 650 properly aligned to magnetic sensor 620. As another example, the user may be instructed to place another credit card, or the like along line 695, and then use the edge of that credit card as a guide for moving their credit card across the face of the device.

In other embodiments of the present invention, the application may operate in a landscape orientation compared to the portrait orientation illustrated in FIGS. 4A-D. Further, with larger display devices, e.g., tablet computer (iPad), the graphical user interfaces may be adjusted for the smaller relative size of the magnetic storage media, e.g. credit card.

FIGS. 5A-D illustrate a process according to various embodiments of the present invention. FIG. 5A illustrates a back of a computing device 700, having a magnetic sensor 710. Similar to embodiments described above, computing

device 700 may be embodied as a hand-held device, a cell-phone, an applications platform, or the like. Further, magnetic sensor 710 may be a magnetic sensing element that is embedded into computing device 600 and configured to sense magnetic fields above display 610, for example. In various embodiments, magnetic sensor 710 may be a MEMS based magnetic sensor. Further, in various embodiments, magnetic sensor 710 may be a MEMS based magnetic sensor having high sensitivity, high field range, and low-noise, such as a MEMS based magnetic sensor described in the patent application incorporated by reference, above.

In FIG. 5B, a back of a computing device 760 may have a series of ridges 780-800. In various embodiments, series of ridges 780-800 may protrude from the back of computing device 760 as shown in the side-view in FIG. 5B. As illustrated, magnetic sensor 770 can be located within computing device 760 and need not be positioned adjacent to the back of computing device 760.

In operation, as illustrated in FIG. 5C, a magnetic storage media 810, e.g. a credit card, having a magnetic strip 820 is shown. As mentioned above, in various embodiments, magnetic strip 820 may include one or more magnetic tracks. In the example shown, when the user pushes magnetic storage media 810 against ridge 790, magnetic sensor 770 is positioned to read data from the middle magnetic track. In the example shown in FIG. 5D, when the user pushes magnetic storage media 810 against ridge 780, magnetic sensor 770 is positioned to read a bottom magnetic track. Further, when the user pushes magnetic storage media 810 against ridge 800, magnetic sensor 770 is positioned to read data from the top magnetic track. Accordingly, as shown, data can be read from any track on the magnetic stripe, depending upon which ridge the credit card is aligned against.

In other embodiments of the present invention, a user may be instructed to place their fingers, thumbnail, another credit card or the like along the display to aid in alignment of the magnetic sensors relative to the magnetic track, or the like. For example, the user may be instructed to place fingers on locations 730 to keep the top edge of a magnetic storage media properly aligned to magnetic sensor 710. As another example, the user may be instructed to place another credit card, or the like along line 740, and then use the edge of that credit card as a guide for moving their credit card across magnetic sensor 710. In various embodiments, an optical mark 720 may be provided to give the user an indication of the reading position of magnetic sensor 770.

In various embodiments, the sensed data may then be used as input to other applications, for example, the credit card number, and other data may be provided for e-commerce applications. In other examples, the magnetic sensors can read magnetic data stored on identification cards, e.g. drivers' licenses, or the like and provide such data to a security program or for security purposes. In other examples, the magnetic sensors can be used to monitor magnetic attached or implanted into a person's body for surveillance or monitoring purposes, or the like.

In still other embodiments, the magnetic sensors may be used to sense and track the localized presence of magnetizable materials (e.g. higher magnetic permeability), such as iron, nickel, steel, another magnet or the like. This may be done by sensing localized perturbations in a global magnetic field (e.g. the Earth's magnetic field) due to the steel, magnet, or the like. In various embodiments, the tracking may be in two dimensions, e.g. along the display plane or surface of the device; or in three dimensions, e.g. along the display plane of the device, in addition to towards and away from the display plane of the device. As merely an example, the magnetic

sensors may be used to track the position of a metal tip of a pen (having a steel ball, iron alloy ball, or the like). For example, a user may “sign” their name on a display of a device by moving the metal-tipped pen across the surface of a display. Although the device may not officially support an external stylus (e.g. iPad), the position of the metal or magnetic-tipped pen tip may be tracked by the on-board magnetic sensors and used. Further, with appropriate pre-calibration between the magnetic sensors and positions on the display of the device, with the sensed data, the display may visually indicate or reflect the positions of the pen on the display. Accordingly, the display can track and display the path drawn by the user across the face of the display. In some examples, the user can then enter hand written notes, sign their name (e.g. signature), or the like on the display by using an ordinary pen. In other embodiments, the user can interact with the user interface of their device with an ordinary metal-tipped pen to perform customary functions such as invoke applications, select data, surf the web, drag and drop, or the like in a similar way they may use their finger(s).

In still other embodiments, the magnetic sensors can track the location of a magnet or metal material (e.g. magnetizable material) in three-dimensions relative to the device. In such embodiments, pre-calibration may be necessary to correlate the locations of magnetic or metal material in three-space. For example, the user may be initially instructed to position the magnet or metal material at certain x, y and z positions relative to the device, e.g. at lattice corners. In various embodiments, once located at specified locations, the magnetic field data sensed by the magnetic sensors is recorded to determine the calibration data. Subsequently, as the user moves the magnet or metal material in three-space, the magnetic sensor data is compared to the calibration data to determine the location of the magnet or metal material in x, y and z space. In one application, the magnetic or metal material may first be positioned at a location on a sculpture; next based upon the magnetic sensor data, the x, y and z position of that location on the sculpture, the x, y and z space coordinates are determined; subsequently, this process is then repeated for other locations on the sculpture. By doing so, in various embodiments, the three-dimensional shape or surface of the sculpture, or the like may be effectively digitized.

As another example, one application may be logging of pressure for scuba diving or for flying. In such an example, a software application running on the computing device may be designed to read pressure data using the included air pressure sensors. In such an example, the application may monitor the air pressure sensor, and when the pressure changes at a sufficient rate (e.g. faster than the weather changing), the computing device may record the change in pressures with respect to time. In the case of a scuba diving application, the pressure may be correlated to diving depth versus time. Such data can then be used by the software application to notify the diver of decompression depths and durations, whether decompression is required, and the like. In the case of a flying application, the air pressure may be correlated to flying altitude. Such data can then be used to warn the user if there is a slow decompression leak in the cabin, to monitor the altitude versus time (e.g. black box), or the like.

As another example, one application may be capturing one or more images of a camera in response to the user tapping upon the case (e.g. back, side, edge) of a device (e.g. phone). For example, while the user points the high resolution camera of their device at the target (e.g. themselves for a self portrait) the user taps the side of the camera. In various embodiments, such a method for initiating capturing of photographs or images is considered by the inventors as a superior method for

taking pictures compared to a user blindly pressing software buttons (mashing) their fingers on a GUI on the display screen, which they cannot see. This sort of situation is commonly found of devices such as the iPhone 4, droid X, HTC Evo 4G for example, when the user takes a high resolution (e.g. ≈ 3 mp) self portrait; when the user is taking a picture in bright sunlight; or the like. In various embodiments, in response to the command for initiating capturing of photographic images (e.g. a sufficiently hard device case finger tap), after a short delay to enable the camera to become stable again, the image may be taken. In various embodiments, the image may be captured once the device becomes stationary (as determined by accelerometers), after the finger tap; a short amount of time after the finger tap; or the like.

In various embodiments, the hand-held device may capture a series of images into a temporary storage and determine one or more images to keep based upon optical parameters of the images (e.g. which image has the least amount of blur); based upon image parameters of the images (e.g. which image has the fastest shutter speed); physical parameters of the hand-held device (e.g. which image was taken at a time having the least amount of associated physical movement based upon the accelerometers, gyroscopes, or the like). In other embodiments, the hand-held device may decide when to take a picture based upon acceleration of the device. For example, the movement of the hand-held device may be monitored, and then when the movement/acceleration is very small, the camera of the hand-held device may be triggered.

In various embodiments the magnitude of the acceleration can be used to set camera parameters such as aperture, ISO rating, shutter speed, and the like. For example, if the magnitude of acceleration is considered large (for example, indicating a urgent, hurried photographic environment), the shutter speed may be increased, the ISO may be increased, the aperture may be decreased (increasing the depth of field), a number of photographs in a burst taken may be increased, or the like; if the magnitude of acceleration is considered small (for example, indicating a quiet, less hurried photographic environment) a volume for a shutter sound may be decreased, the ISO may be decreased, the aperture may be decreased (decreasing the depth of field), or the like.

In other embodiments, the user tapping on the case, as described above, may be used to initiate other types of operations by the computer system. For example a single tap on the back of the computer system may initiate a process for recording audio signals via a microphone, and a double tap on the back may pause or finish the recording of audio signals. As merely another example, a single tap may be used by a user to answer a telephone call, a double tap may be used to mute and unmute a telephone call, a triple tap may be used by the user to hang up the telephone call. A tap near the top of the computer system device may increase the audio playback volume and a tap near the bottom of the device may decrease the playback volume, or the like.

Further embodiments can be envisioned to one of ordinary skill in the art after reading this disclosure. In other embodiments, combinations or sub-combinations of the above disclosed invention can be advantageously made. The block diagrams of the architecture and flow charts are grouped for ease of understanding. However it should be understood that combinations of blocks, additions of new blocks, re-arrangement of blocks, and the like are contemplated in alternative embodiments of the present invention.

The specification and drawings are, accordingly, to be regarded in an illustrative rather than a restrictive sense. It will, however, be evident that various modifications and

changes may be made thereunto without departing from the broader spirit and scope of the invention as set forth in the claims.

What is claimed is:

1. A computer implemented method for processing data stored on a magnetic stripe of a user provided medium performed by a hand-held computer system programmed to perform the method comprising:

displaying, with a processor disposed within the computer system, a first alignment graphical user interface on a display of the computer system, wherein the first alignment graphical user interface includes a first visual alignment mark, wherein the first alignment mark is positioned on the display relative to a position of a MEMS magnetic field sensor disposed within the computer system at a first offset, wherein when a user aligns the user provided medium to the first alignment mark on the display, a portion of a first track of the magnetic stripe is disposed above the MEMS magnetic field sensor;

sensing, by the MEMS magnetic field sensor, a plurality of magnetic data stored on the first track of the magnetic stripe, in response to the user aligning the user provided medium to the first alignment mark, and moving the user provided medium along the first alignment mark; and determining, with the processor, a plurality of user data stored on the first track of the magnetic stripe in response to the plurality of magnetic data stored on the first track.

2. The computer implemented method of claim 1 further comprising:

displaying, with the processor, a second alignment graphical user interface on a display of the computer system, wherein the second alignment graphical user interface includes a second visual alignment mark, wherein the second alignment mark is positioned on the display relative to the MEMS magnetic field sensor at a second offset, wherein when the user aligns the user provided medium to the second first alignment mark on the display, a second track of the magnetic stripe is disposed above the MEMS magnetic field sensor;

sensing, by the MEMS magnetic field sensor, a plurality of magnetic data stored on the second track of the magnetic stripe, in response to the user aligning the user provided medium to the second alignment mark, and moving the user provided medium along the second alignment mark; and

determining, with the processor, a plurality of user data stored on the second track of the magnetic stripe in response to the plurality of magnetic data stored on the second track.

3. The computer implemented method of claim 1 further comprising:

outputting, with the processor, at least a portion of the plurality of user data to a remote destination, via a communications interface disposed within the computer system.

4. The computer implemented method of claim 1 wherein the sensing comprises sensing, by a foundry-compatible-process manufactured MEMS magnetic sensor, the plurality of magnetic data stored on the first track of the magnetic stripe.

5. The computer implemented method of claim 1 wherein the sensing comprises sensing, by at least one axis of a three-axis MEMS magnetic field sensor, the plurality of magnetic data stored on the first track of the magnetic stripe.

6. The computer implemented method of claim 1 wherein the sensing comprises sensing, by the MEMS magnetic field sensor, the plurality of magnetic data stored on the first track of the magnetic stripe of the user provided medium,

wherein the user provided medium is selected from a group consisting of: a credit card, a bank card, a debit card, a drivers license, an identification card.

7. The computer implemented method of claim 1 further comprising displaying, with the processor, a progress graphical user interface on the display, wherein the progress graphical user interface is moved on the display in response to movement of the user provided medium relative to the display.

8. The computer implemented method of claim 1 wherein the first alignment graphical user interface instructs the user to place a finger at the first visual alignment mark.

9. The computer implemented method of claim 1 wherein the first alignment graphical user interface instructs the user to place a straight-edge along the first visual alignment mark.

10. The computer implemented method of claim 1 wherein the first alignment graphical user interface includes an indicia positioned on the display indicating the position of the MEMS magnetic field sensor relative to the display.

11. A hand-held computer system for processing data stored on a magnetic stripe of a user provided medium comprising:

a housing;

a tangible memory for storing a plurality of non-transitory executable instructions;

a display disposed within the housing, wherein the display is configured to display a plurality of graphical user interfaces to a user;

a MEMS magnetic field sensor disposed within the housing, wherein the MEMS magnetic field sensor is configured to sense magnetic data stored within a magnetic stripe of the user provided medium; and

a processor disposed within the housing and coupled to the tangible memory, the display, and to the MEMS magnetic field sensor, wherein the processor is programmed to perform a plurality of functions by the plurality of non-transitory executable instructions;

wherein the plurality of non-transitory executable instructions comprise:

executable code that programs the processor to display a first alignment graphical user interface on the display, wherein the first alignment graphical user interface includes a first visual alignment mark, wherein the first alignment mark is positioned on the display relative to a position of the MEMS magnetic field sensor at a first offset, wherein when the user aligns the user provided medium to the first alignment mark on the display, a portion of a first track of the magnetic stripe is sensed by the MEMS magnetic field sensor; and executable code that programs the processor to determine a plurality of user data stored on the first track of the magnetic stripe, in response to magnetic data stored within the first track of the magnetic stripe sensed by the MEMS magnetic field sensor when the user moves the user provided medium along the first alignment mark.

12. The hand-held computer system of claim 11 wherein the plurality of non-transitory executable instructions comprise:

executable code that programs the processor to display a second alignment graphical user interface on the display, wherein the second alignment graphical user interface includes a second visual alignment mark, wherein the

19

second alignment mark is positioned on the display relative to the position of the MEMS magnetic field sensor at a second offset, wherein when the user aligns the user provided medium to the second alignment mark on the display, a portion of a second track of the magnetic stripe is sensed by the MEMS magnetic field sensor;

executable code that programs the processor to determine a plurality of user data stored on the second track of the magnetic stripe, in response to magnetic data stored within the second track of the magnetic stripe sensed by the MEMS magnetic field sensor when the user moves the user provided medium along the second alignment mark.

13. The hand-held computer system of claim 11 further comprising:

a communications interface disposed within the housing, wherein the communications interface is configured to output data; and

wherein the plurality of non-transitory executable instructions further comprises executable code that programs the processor to provide at least a portion of the plurality of user data to a remote destination via the communications interface.

14. The hand-held computer system of claim 11 wherein the MEMS magnetic field sensor comprises a foundry-compatible-process manufactured MEMS magnetic sensor.

20

15. The hand-held computer system of claim 11 wherein the MEMS magnetic field sensor comprises a three-axis MEMS magnetic field sensor.

16. The hand-held computer system of claim 11 wherein the user provided medium is selected from a group consisting of: a credit card, a bank card, a debit card, a drivers license, an identification card.

17. The hand-held computer system of claim 11 wherein the plurality of non-transitory executable instructions further comprises:

executable code that programs the processor to display a progress graphical user interface on the display, wherein the progress graphical user interface is moved on the display in response to movement of the user provided medium relative to the display.

18. The hand-held computer system of claim 11 wherein the first alignment graphical user interface instructs the user to place a finger at the first visual alignment mark.

19. The hand-held computer system of claim 11 wherein the first alignment graphical user interface instructs the user to place a straight-edge along the first visual alignment mark.

20. The hand-held computer system of claim 11 wherein the first alignment graphical user interface includes an indicia positioned on the display indicating the position of the MEMS magnetic field sensor relative to the display.

* * * * *