

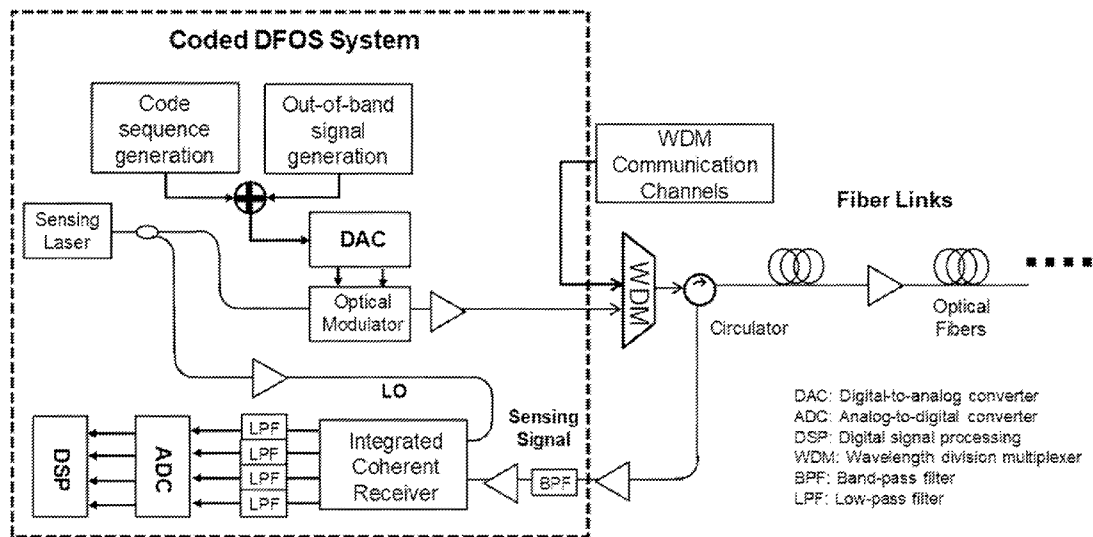

- (51) **International Patent Classification:**  
H04B 10/25 (2013.01) H04B 10/2537 (2013.01)  
H04B 10/075 (2013.01)
- (21) **International Application Number:**  
PCT/US2021/026039
- (22) **International Filing Date:**  
06 April 2021 (06.04.2021)
- (25) **Filing Language:** English
- (26) **Publication Language:** English
- (30) **Priority Data:**  
63/006,218 07 April 2020 (07.04.2020) US  
17/221,837 04 April 2021 (04.04.2021) US
- (71) **Applicant:** NEC LABORATORIES AMERICA, INC. [US/US]; Suite 200, 4 Independence Way, Princeton, New Jersey 08540 (US).
- (72) **Inventors:** HUANG, Yue-Kai; 89 Hoover Avenue, Princeton, New Jersey 08540 (US). IP, Ezra; 6 Canoe Brook Drive, West Windsor, New Jersey 08550 (US). YAMAN, Fatih; 31 Garfield Way, Princeton, New Jersey 08540 (US).

- (74) **Agent:** KOLODKA, Joseph; NEC Laboratories America, Inc., 4 Independence Way, Suite 200, Princeton, New Jersey 08540 (US).
- (81) **Designated States** (unless otherwise indicated, for every kind of national protection available): AE, AG, AL, AM, AO, AT, AU, AZ, BA, BB, BG, BH, BN, BR, BW, BY, BZ, CA, CH, CL, CN, CO, CR, CU, CZ, DE, DJ, DK, DM, DO, DZ, EC, EE, EG, ES, FI, GB, GD, GE, GH, GM, GT, HN, HR, HU, ID, IL, IN, IR, IS, IT, JO, JP, KE, KG, KH, KN, KP, KR, KW, KZ, LA, LC, LK, LR, LS, LU, LY, MA, MD, ME, MG, MK, MN, MW, MX, MY, MZ, NA, NG, NI, NO, NZ, OM, PA, PE, PG, PH, PL, PT, QA, RO, RS, RU, RW, SA, SC, SD, SE, SG, SK, SL, ST, SV, SY, TH, TJ, TM, TN, TR, TT, TZ, UA, UG, US, UZ, VC, VN, WS, ZA, ZM, ZW.
- (84) **Designated States** (unless otherwise indicated, for every kind of regional protection available): ARIPO (BW, GH, GM, KE, LR, LS, MW, MZ, NA, RW, SD, SL, ST, SZ, TZ, UG, ZM, ZW), Eurasian (AM, AZ, BY, KG, KZ, RU, TJ, TM), European (AL, AT, BE, BG, CH, CY, CZ, DE, DK, EE, ES, FI, FR, GB, GR, HR, HU, IE, IS, IT, LT, LU, LV, MC, MK, MT, NL, NO, PL, PT, RO, RS, SE, SI, SK, SM,

(54) **Title:** CONSTANT AMPLITUDE CODED DFOS USING OUT-OF-BAND SIGNALING



**FIG. 1**

(57) **Abstract:** Aspects of the present disclosure describe distributed fiber optic sensing (DFOS) systems, methods, and structures that advantageously overcome problems encountered when operating DFOS systems over operational telecommunications facilities namely, cross-phase modulation, and uneven amplitude profiles through the use of a novel constant amplitude coded DFOS employing out-of-band signaling.



TR), OAPI (BF, BJ, CF, CG, CI, CM, GA, GN, GQ, GW,  
KM, ML, MR, NE, SN, TD, TG).

**Published:**

— *with international search report (Art. 21(3))*

**CONSTANT AMPLITUDE CODED DFOS USING OUT-OF-BAND SIGNALING****TECHNICAL FIELD**

**[0001]** This disclosure relates generally to distributed fiber optic sensing (DFOS) and telecommunications over a common optical fiber conveying both DFOS signals and telecommunications signals simultaneously.

**BACKGROUND**

**[0002]** A major impediment to integrating DFOS and telecommunications signals on a common optical fiber is nonlinear cross-talk that occurs between the two types of signals. Given the contemporary interest in such simultaneous operation of DFOS and telecommunications over a common optical fiber, – systems, methods, and structures that permit or otherwise improve such simultaneous operation would be a welcome addition to the art.

**SUMMARY**

**[0003]** An advance in the art is made according to aspects of the present disclosure directed to distributed fiber optic sensing systems (DFOS), methods, and structures that advantageously overcome problems encountered when operating DFOS systems over operational telecommunications facilities namely, cross-phase modulation, and uneven amplitude profiles.

**[0004]** In sharp contrast to the prior art, systems, methods, and structures according to aspects of the present disclosure employ a novel constant amplitude coded DFOS employing out-of-band signaling.

**[0005]** According to aspects of the present disclosure, with our coded DFOS system, an out-of-band signal is generated and sent along with a coded sequence. The signal generation is synchronized such that the combination of the coded sequence and the out-of-band signal combined together yields a constant amplitude. When

interrogating the fiber using the combined signal, the system is surprisingly free of large power fluctuations and therefore minimize cross-phase modulation XPM distortion to neighboring communication channels. Also – by using the constant amplitude generated in our scheme, all parts of the coded sequence receive an equal gain after optical amplification - free of amplifier dynamics. Advantageously, an out-of-band signal can then be removed during signal detection by a receiver either by optical, electrical, or digital filtering techniques - depending on system design.

### **BRIEF DESCRIPTION OF THE DRAWING**

[0006] A more complete understanding of the present disclosure may be realized by reference to the accompanying drawing in which:

[0007] **FIG. 1** is a schematic diagram illustrating a coded constant-amplitude DFOS system with out-of-band signal generation according to aspects of the present disclosure;

[0008] **FIG. 2(A)** and **FIG. 2(B)** are a pair of plots showing: **FIG. 2(A)** a typical coded sequence using chirped frequencies for DAS interrogation; and **FIG. 2(B)** a corresponding autocorrelation function in logarithm scale according to aspects of the present disclosure;

[0009] **FIG. 3(A)** and **FIG. 3(B)** are a pair of plots showing: **FIG. 2(A)** a chirp coded sequence distorted by EDFA gain dynamics; and **FIG. 3(B)** a corresponding autocorrelation function in logarithm scale according to aspects of the present disclosure;

[0010] **FIG. 4(A)** and **FIG. 4(B)** are a pair of plots showing constant amplitude interrogation signal using out-of-band single frequency tone: wherein **FIG. 4(A)** is a temporal waveform; and **FIG. 4(B)** a frequency spectrum according to aspects of the present disclosure; and

[0011] FIG. 5(A) and FIG. 5(B) are a pair of plots showing constant amplitude interrogation signal using chirped out-of-band signal: wherein FIG. 5(A) is a temporal waveform; and FIG. 4(B) a frequency spectrum according to aspects of the present disclosure.

## DESCRIPTION

[0012] The following merely illustrates the principles of the disclosure. It will thus be appreciated that those skilled in the art will be able to devise various arrangements which, although not explicitly described or shown herein, embody the principles of the disclosure and are included within its spirit and scope.

[0013] Furthermore, all examples and conditional language recited herein are intended to be only for pedagogical purposes to aid the reader in understanding the principles of the disclosure and the concepts contributed by the inventor(s) to furthering the art and are to be construed as being without limitation to such specifically recited examples and conditions.

[0014] Moreover, all statements herein reciting principles, aspects, and embodiments of the disclosure, as well as specific examples thereof, are intended to encompass both structural and functional equivalents thereof. Additionally, it is intended that such equivalents include both currently known equivalents as well as equivalents developed in the future, i.e., any elements developed that perform the same function, regardless of structure.

[0015] Thus, for example, it will be appreciated by those skilled in the art that any block diagrams herein represent conceptual views of illustrative circuitry embodying the principles of the disclosure.

[0016] Unless otherwise explicitly specified herein, the FIGs comprising the drawing are not drawn to scale.

**[0017]** By way of some additional background, we begin by noting that distributed fiber optic sensing (DFOS) is an important and widely used technology to detect environmental conditions (such as temperature, vibration, stretch level etc.) anywhere along an optical fiber cable that in turn is connected to an interrogator. As is known, contemporary interrogators are systems that generate an input signal to the fiber and detects / analyzes the reflected/scattered and subsequently received signal(s). The signals are analyzed, and an output is generated which is indicative of the environmental conditions encountered along the length of the fiber. The signal(s) so received may result from reflections in the fiber, such as Raman backscattering, Rayleigh backscattering, and Brillouin backscattering. It can also be a signal of forward direction that uses the speed difference of multiple modes. Without losing generality, the following description assumes reflected signal though the same approaches can be applied to forwarded signal as well.

**[0018]** As will be appreciated, a contemporary DFOS system includes an interrogator that periodically generates optical pulses (or any coded signal) and injects them into an optical fiber. The injected optical pulse signal is conveyed along the optical fiber.

**[0019]** At locations along the length of the fiber, a small portion of signal is reflected and conveyed back to the interrogator. The reflected signal carries information the interrogator uses to detect, such as a power level change that indicates – for example - a mechanical vibration.

**[0020]** The reflected signal is converted to electrical domain and processed inside the interrogator. Based on the pulse injection time and the time signal is detected, the interrogator determines at which location along the fiber the signal is coming from, thus able to sense the activity of each location along the fiber.

**[0021]** Those skilled in the art will understand and appreciate that by implementing a signal coding on the interrogation signal enables the sending of more

optical power into the fiber which can advantageously improve signal-to-noise ratio (SNR) of Rayleigh-scattering based system (e.g. distributed acoustic sensing or DAS) and Brillouin-scattering based system (e.g. Brillouin optical time domain reflectometry or BOTDR).

**[0022]** As currently implemented in contemporary implementations, dedicated fibers are assigned to DFOS systems in fiber-optic cables – physically separated from existing optical communication signals which are conveyed in different fiber(s). However, given the explosively growing bandwidth demands, it is becoming much more difficult to economically operate and maintain optical fibers for DFOS operations only. Consequently, there exists an increasing interest to integrate communications systems and sensing systems on a common fiber.

**[0023]** One of the greatest challenges in integrating sensing and communication signals on the same fiber as noted previously is the nonlinear cross-talk that occurs between the sensing and communications signals. One reason is that the instantaneous operation power of the DFOS signals is much higher as compared to the communications signals (channels), thus degrading communications performance due to fiber nonlinearity. Implementing a signal coding in DFOS allows reduction of the instantaneous operation power in the interrogation signal, however, there still exists a large power fluctuation in the beginning and the falling edges of the code sequence – which in turn leads to cross phase modulation (XPM) distortion on neighboring wavelength division multiplexed (WDM) communication channels.

**[0024]** Yet another difficulty when applying a coding to a DFOS system is the signal amplification. As is known and understood, an erbium-doped fiber amplifier (EDFA) arguably remains the best medium for optical signal amplification and as a result they are widely used in communications fibers. With respect to a possible signal coding noted, as the length of a code sequence increases, however, it approaches the carrier recovery time of the erbium atoms. As a result, an amplified output signal will exhibit an uneven amplitude profile and the code sequence will experience a decreasing gain over

the period of the whole sequence. If uncorrected, the uneven amplitude profile will affect the auto-correlation function of the implemented code and cause signal crosstalk between different fiber segments in the DFOS system.

**[0025]** FIG. 1 is a schematic block diagram of a coded constant-amplitude DFOS system with out-of band signal generation according to aspects of the present disclosure. In the depicted block diagram, we illustratively show how out-of-band signal generation will be applied to the DFOS system according to aspects of the present disclosure.

**[0026]** Operationally, we assume that the DFOS system will be Rayleigh-scattering based system (e.g. distributed acoustic sensing or DAS) and Brillouin-scattering based system (e.g. Brillouin optical time domain reflectometry or BOTDR) with a coding implementation. With such coding designs, these systems will be most likely be integrated with fiber communication systems due to their lower power operation and will also be more affected by the optical amplifier response time.

**[0027]** In the arrangement illustratively shown in the block diagram, we assume that the coded interrogation sequence is generated digitally and modulated onto the sensing laser via digital-to-analog-conversion (DAC) and an optical modulator. The modulated interrogation sequence may be amplified to optimal operation power before being directed into the fiber for interrogation.

**[0028]** Advantageously, the DFOS operation may also be integrated together with communication channels via WDM in the same fiber. Inside the sensing fiber, the interrogation sequence and the returned sensing signal may be optically amplified - either via discrete (EDFA/SOA) or distributed (Raman) methods. A returned sensing signal is routed to a coherent receiver after amplification and optical band-pass filtering. The coherent receiver detects the optical fields in both polarizations of the signal, down-converting them to 4 baseband lanes for analog-to-digital conversion (ADC) sampling and digital signal processor (DSP) processing. As those skilled in the art will readily understand and appreciate, the decoding operation is done in the DSP to generate the



interrogated Rayleigh or Brillouin response of the fiber, and the changes in the response is then identified and interpreted for sensor readouts.

**[0029]** With continued reference to the figure, since the coded interrogation sequence is generated digitally, the out-of-band signal is also generated digitally, and then combined with the code sequence before waveforms are created by the DAC. When generated together digitally, the out-of-band signal will only be generated outside the time period of the code sequence, so when added together, the combined waveform will have a constant amplitude.

**[0030]** Note that it is also possible to generate the out-of-band signal separately using a different DAC or waveform generator and combine it with a code-sequence. In that illustrative scenario, any separate modules need to be synchronized so that their relative waveform start/end time match such that the combined waveform maintains a constant amplitude.

**[0031]** Advantageously, it is also possible to optically generate the out-of-band signal and combine it with the code sequence in the optical domain.

**[0032]** Note that during the transmission, interrogation, and reception of the DFOS signal, the signal will be amplified by one or multiple optical amplifiers. With extended code length, a signal will experience different gain in the different part of the code sequence due to the optical amplifier carrier recovery response, if the signal is not a constant amplitude across the interrogation frame. According to aspects of the present disclosure - with our innovation - the out-of-band signal combined with the code sequence will keep the overall signal amplitude constant, and therefore stabilize the gain response.

**[0033]** In the case where sensing signals share the same fiber as WDM communication channels, keeping the signals at a constant amplitude will advantageously result in a performance benefit as well. Fiber nonlinearity crosstalk due to XPM, which

can be problematic during the rising and falling edges of code sequences, will be minimized according to our inventive techniques. More particularly, the combined sensing signal will remove the amplitude fluctuations exhibited in the original code sequence and therefore mitigate XPM crosstalk.

**[0034]** We note that the out-of-band signal has no actual contribution in the coding/decoding operation of the DFOS system. After reception of the sensing signal, it is removed from the coded signal before decoding by the DSP. The removal can be done by optical, electrical, or digital filters. Since the sensing signal likely exhibits a narrow band, so we assume an optical filter will not be used. As such, in the illustrative block diagram, we assume electrical filtering is used for cost and complexity purposes as lower sampling speed can be adopted for ADC after LPF.

**[0035]** To further describe aspects of our inventive disclosure, we use a coded DAS system which uses chirped code sequence as an example. The real and imaginary waveform of the chirp sequence is shown in **FIG. 2(A)**. The length of the sequence is 127 chip, with any remainder of the interrogation frame filled with zeros.

**[0036]** The autocorrelation function of the sequence is shown in **FIG. 2(B)**, with the response falling quickly below -15 dB after the first side lobe. The autocorrelation property of code allows the DAS interrogator to send a long sequence, with more optical power, into the fiber to achieve better SNR, while maintaining the spatial resolution (~2 chip) of distributive sensing after decoding

**[0037]** One challenge in using a long sequence for DFOS system is the amplification of the optical interrogation sequence and the returned sensing signal and it. Optical amplifiers such as EDFA and SOA has gain dynamics which correspond to the carrier recovery time, this will create uneven gain response across the code sequence, because the input signal to the amplifier has uneven power distribution in time. This phenomenon is illustrated in **FIG. 3(A)**, as the initial part of the code sequence traverses the EDFA, the carriers start to deplete and the latter part(s) of the sequence receive less

and less gain. This gain dynamic will distort the code sequence, and, as a result, the corresponding autocorrelation function, shown in **FIG. 3(B)**, will be impacted. Compared to **FIG. 2(B)**, the ratio of the autocorrelation peak to the side interference has reduced, thus the DAS performance after decoding will suffer as a result. The gain dynamic issue will also affect the DFOS system via optical amplifiers used in the fiber links as well as the receiver amplifiers since the returned sensing signal also exhibit uneven power profile over time.

**[0038]** Yet another problem is when a DFOS system is integrated with existing communication systems / signals in a same / common optical fiber. We note that this problem is not limited to DFOS with coding - in fact by using a coding DFOS system we can reduce the operation signal power which can help with this issue. The main problem is due primarily to a large fiber nonlinearity cross-talk that occurs due to the large power fluctuation(s) of the DFOS interrogation signal(s). The large power fluctuation is clearly observed in our example of chirped code sequence shown in **FIG. 2(A)**, as the rising and falling edges of the sequence has large optical amplitude swings. These instances will create nonlinear cross-talks to neighboring communication channels due to XPM, if the sensing signal is integrated via WDM.

**[0039]** Advantageously, systems, methods, and structures according to our inventive disclosure specifically solve these two main issues by creating an out-of-band signal which is amplified and transmitted together with a main code sequence. One of such example is shown in **FIG. 4(A)**, where a single frequency tone is used as the out-of-band signal. The single frequency waveform is added outside of the time occupied by the code sequence with equal amplitude so that the combined signal will achieve constant amplitude. (Note that only the real part of the signal is shown.) The tone frequency is deliberately selected to be outside of the code sequence operation frequency band, as shown in **FIG. 4(B)**. Therefore, the out-of-band signal can be easily removed by filtering before decoding process at the DFOS receiver DSP.

**[0040]** With the added out-of-band signal, the interrogation signal and the returned sensing signal will have constant amplitude distributed across time. In this case, the optical amplification process reaches an equilibrium in the amplifier dynamics and the gain response distortion is substantially eliminated. Advantageously, the large power fluctuations from the original code sequence are also removed. Therefore, the resulting interrogation signal waveform will have exhibit a much reduced XPM nonlinear crosstalk with neighboring communication channels if they are integrated in the same fiber.

**[0041]** We not note that according to aspects of the present disclosure, there are several ways to create and combine the out-of-band signal. A most convenient way is shown in the example illustrated in **FIG. 1**, that both the main code sequence and the out-of-band signal is created and combined digitally before waveform generation by DAC. As those skilled in the art will readily appreciate, this reduces the number of hardware components, however the sampling speed and bandwidth of the DAC may need to be higher due to the expanded frequency band generation.

**[0042]** Another way to is to generate the electrical waveforms for the code sequence and out-of-band separately and combine them before optical modulation by electrical power combiners. In this case the out-of-band signal can be generated via an RF frequency source or function generators. This method is more complex as the two signal generators need to be synchronized in time and the signal amplitudes adjusted separately to achieve the constant amplitude in the combined signal.

**[0043]** Yet another way is to combine the code-sequence and out-of-band signal optically after generating the optical signals separately. One such example is that the out-of-band signal can be created via acoustic-optic modulator (AOM) where the intrinsic modulator frequency shift can be used to move the laser frequency out of the band. Like the previous case, the two signal generators need to be synchronized and their amplitude tuned to achieve constant amplitude.

**[0044]** For decoding operation in the DFOS, the out-of-band signal needs to be removed from the returned sensing signal. This can be done simply by filtering in optical, electrical, and digital domain. A cost-effective way is electrical low-pass filtering, as shown in **FIG. 1** before the ADC. Compared to implementing digital filtering for the added out-of-band signal, it allows the use of lower sampling rate/bandwidth for the ADC, as well as reduce DSP resources required for filtering processes. Optical filters, having wide bandwidths, are likely not suitable for this process, however if the out-of-band signal is located far away from the main code sequence ( $>10$  GHz), then such method can likely be used.

**[0045]** One should note that systems, methods, and structures according to aspects of the present disclosure do not specifically limit the out-of-band signal waveform to a single frequency tone. In **FIG. 5(A)**, we illustrate an example of using chirped waveform as the out-of-band signal. The out-of-band waveform is a frequency shifted version of the original code sequence. The out-of-band waveform is repeated multiple times outside of the time occupied by the code sequence. As the original chirped sequence and the frequency shifted version both have constant amplitudes, the combined signal will achieve constant amplitude as well. (Note that only the real part of the signal is shown.) The frequency-shifted out-of-band chirped signal is separated from the original code sequence, shown in **FIG. 5(B)**. Other of out-of-band waveforms which exhibit constant amplitude property are M-ary phase-shift-keying (mPSK) signals, which can also be adopted as out-of-band signal for coded DFOS system

**[0046]** At this point, while we have presented this disclosure using some specific examples, those skilled in the art will recognize that our teachings are not so limited. Accordingly, this disclosure should only be limited by the scope of the claims attached hereto.

## Claims:

1. A coded distributed fiber optic sensing (DFOS) system comprising:
  - a length of optical fiber cable;
  - a DFOS interrogator system in optical communication with the length of optical fiber cable;
  - an intelligent analyzer configured to analyze DFOS sensing data received by the DFOS interrogator system;
  - the distributed fiber optic sensing system CHARACTERIZED BY
    - a code sequence generator that generates a coded interrogation sequence;
    - and
    - an out of band signal generator that generates an out-of-band signal (OOS), said OOS being combined with the coded interrogation sequence prior to introduction into the optical fiber cable;
  - wherein the OOS is not used by the DFOS system as part of any DFOS sensing data analysis.
2. The DFOS system of claim 1 FURTHER CHARACTERIZED BY the OOS is filtered out of any DFOS sensing data prior to its analysis.
3. The DFOS system of claim 2 FURTHER CHARACTERIZED BY the OOS is synchronized with the coded interrogation sequence such that the combination of the two signals is a signal exhibiting a constant amplitude waveform.
4. The DFOS system of claim 3 FURTHER CHARACTERIZED IN THAT the combined signals are output to the optical fiber and using the constant amplitude characteristic of the signal an equalized gain for the coded sequence is produced.

5. The DFOS system of claim 4 FURTHER CHARACTERIZED IN THAT the DFOS system is integrated in that the optical fiber simultaneously conveys non-sensory telecommunications optical signals.

6. The DFOS system of claim 5 FURTHER CHARACTERIZED IN THAT DFOS interrogation signals and the non-sensory telecommunications signals are wavelength-division-multiplexed into the optical fiber.

7. The DFOS system of claim 6 FURTHER CHARACTERIZED IN THAT the constant amplitude characteristic of the interrogation signals improves any nonlinear cross-talk characteristics with the telecommunications signals due to reduced cross-phase modulation – as compared with an operation using interrogation signals that did not exhibit the constant amplitude.

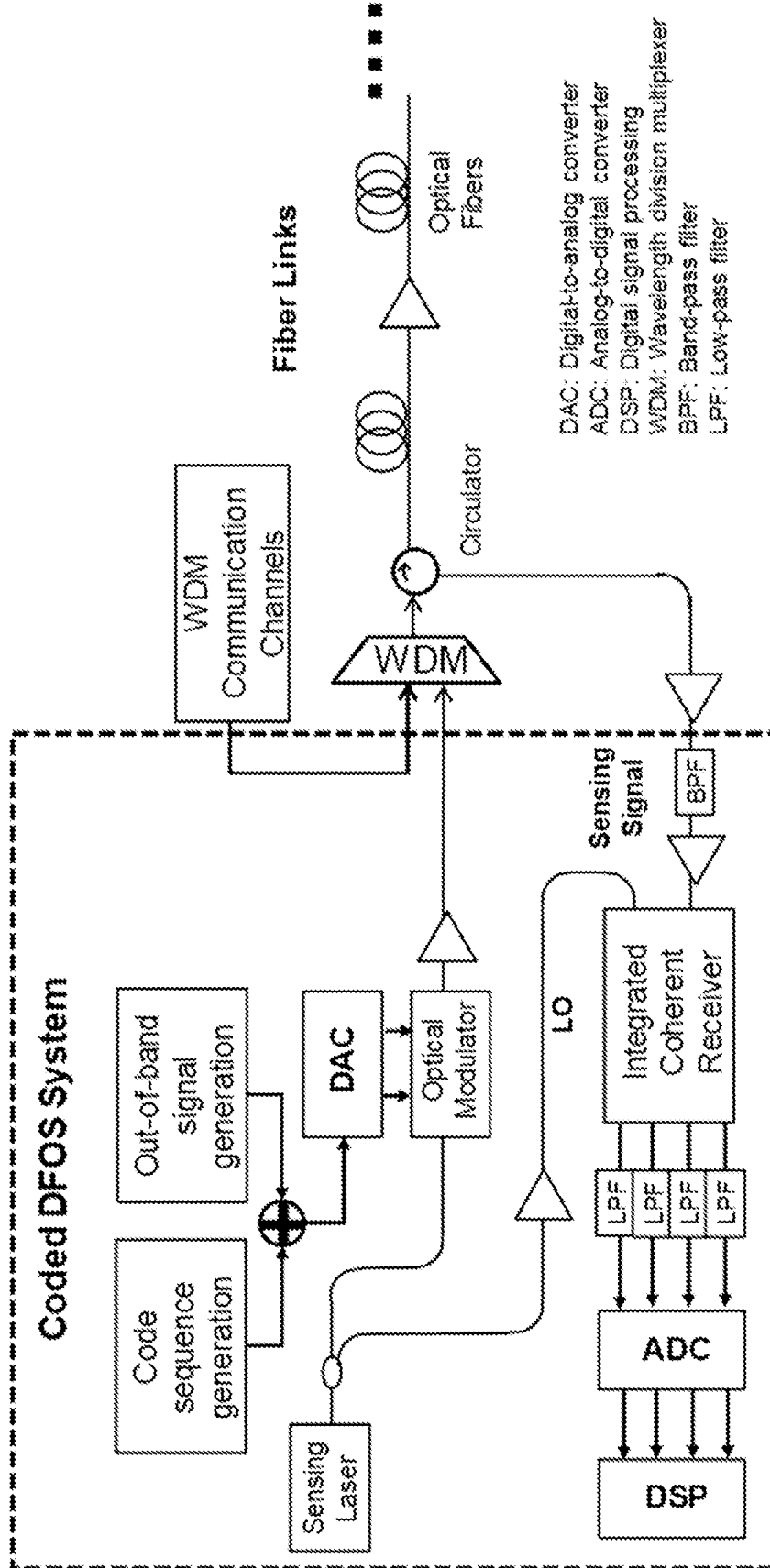
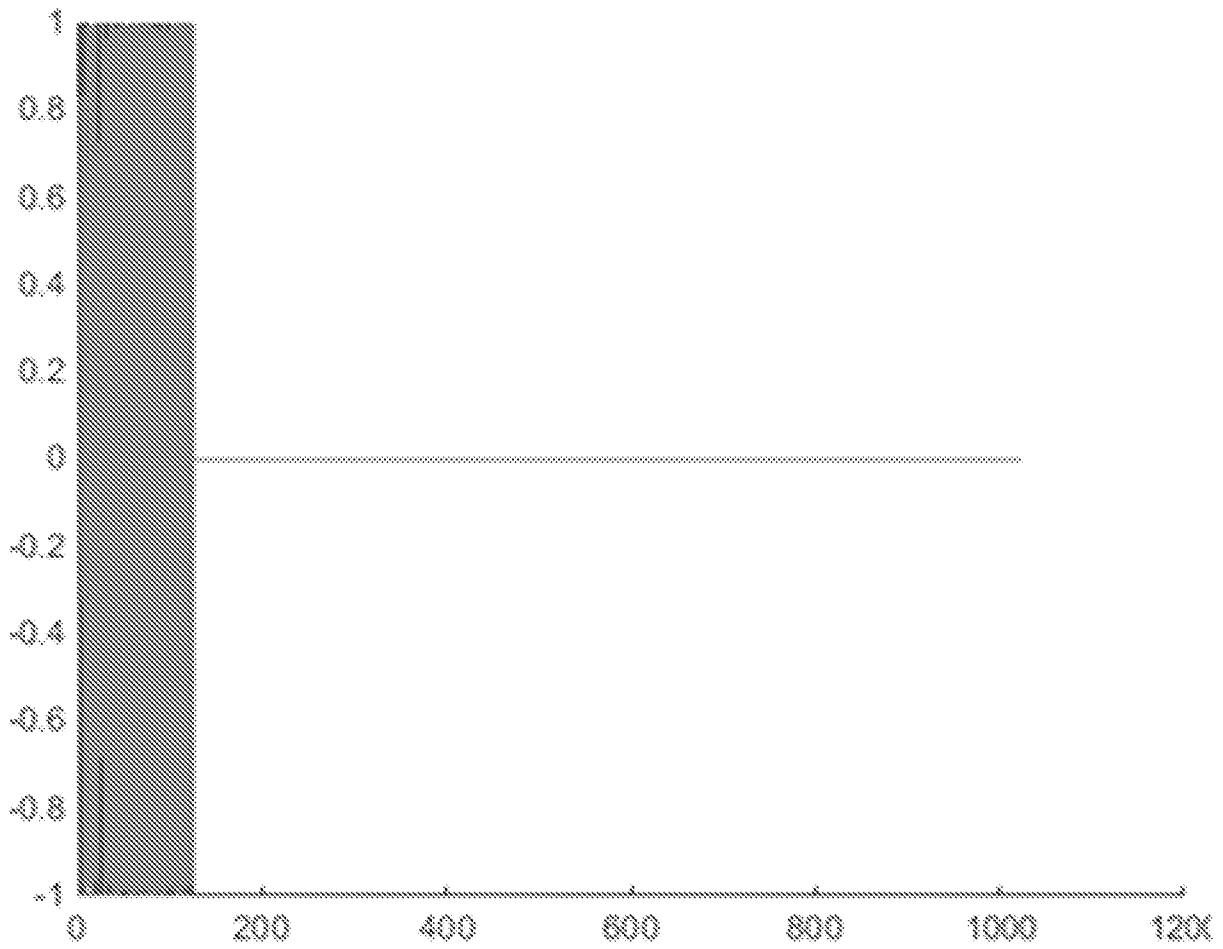
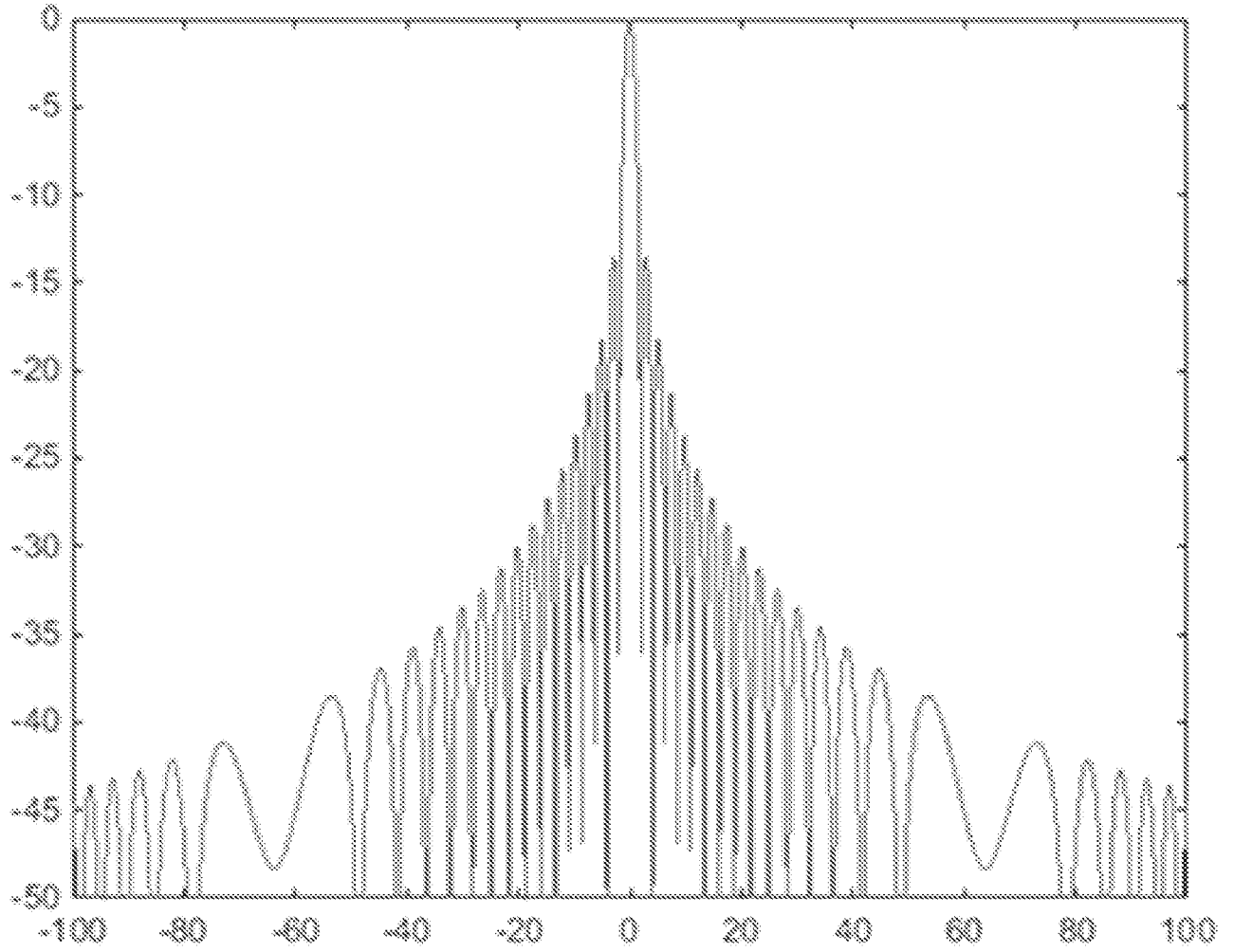

FIG. 1

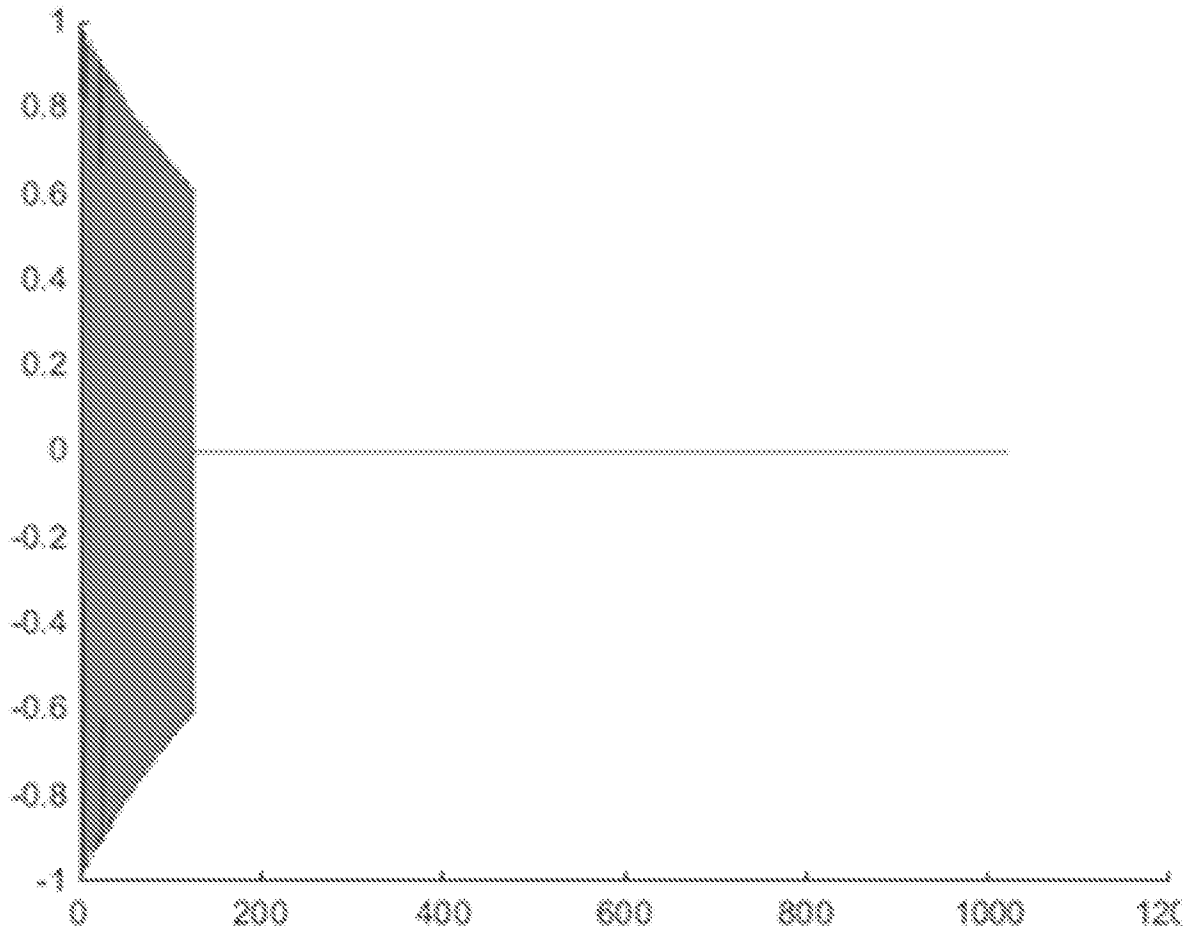



***FIG. 2(A)***



**FIG. 2(B)**



**FIG. 3(A)**

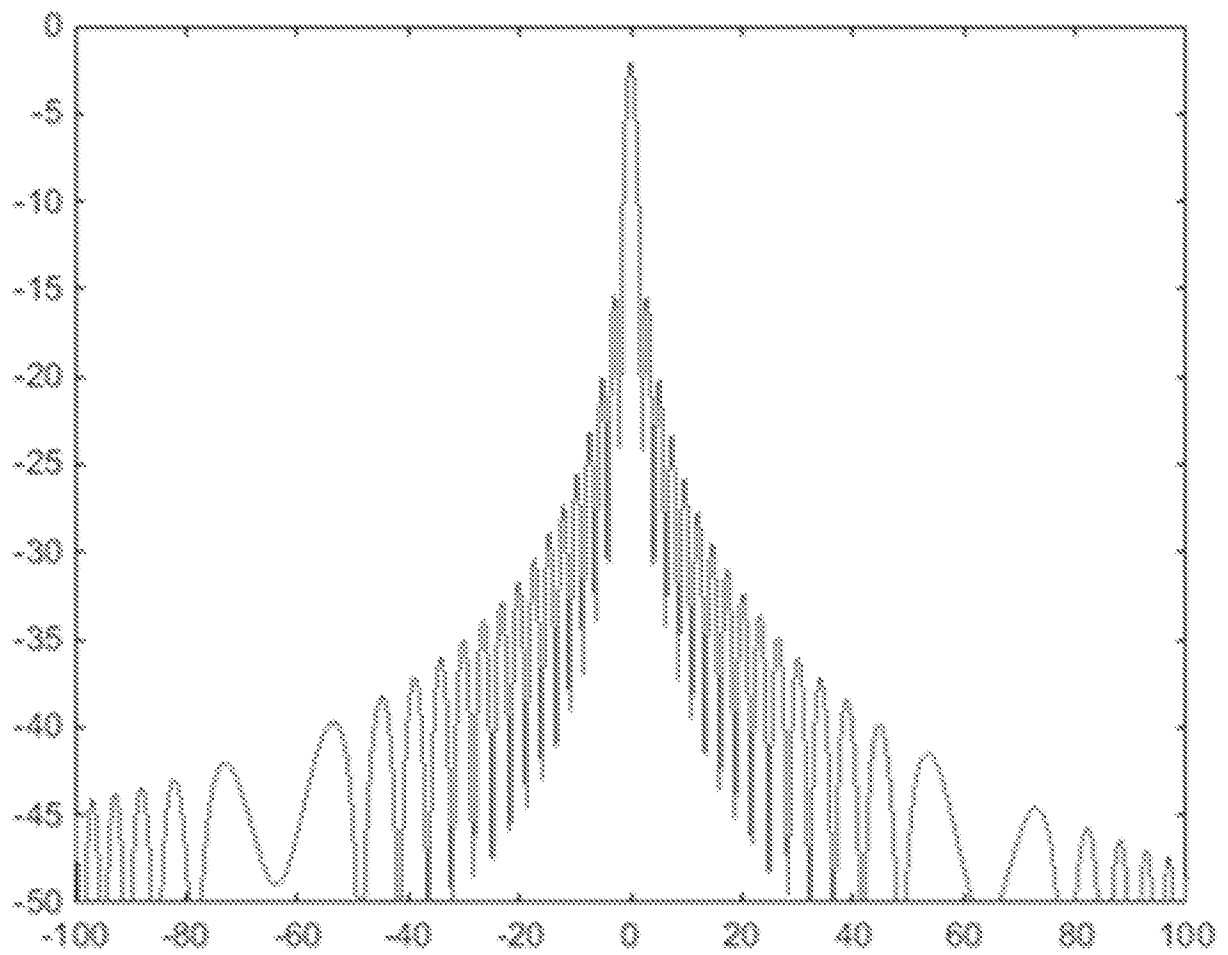

**FIG. 3(B)**

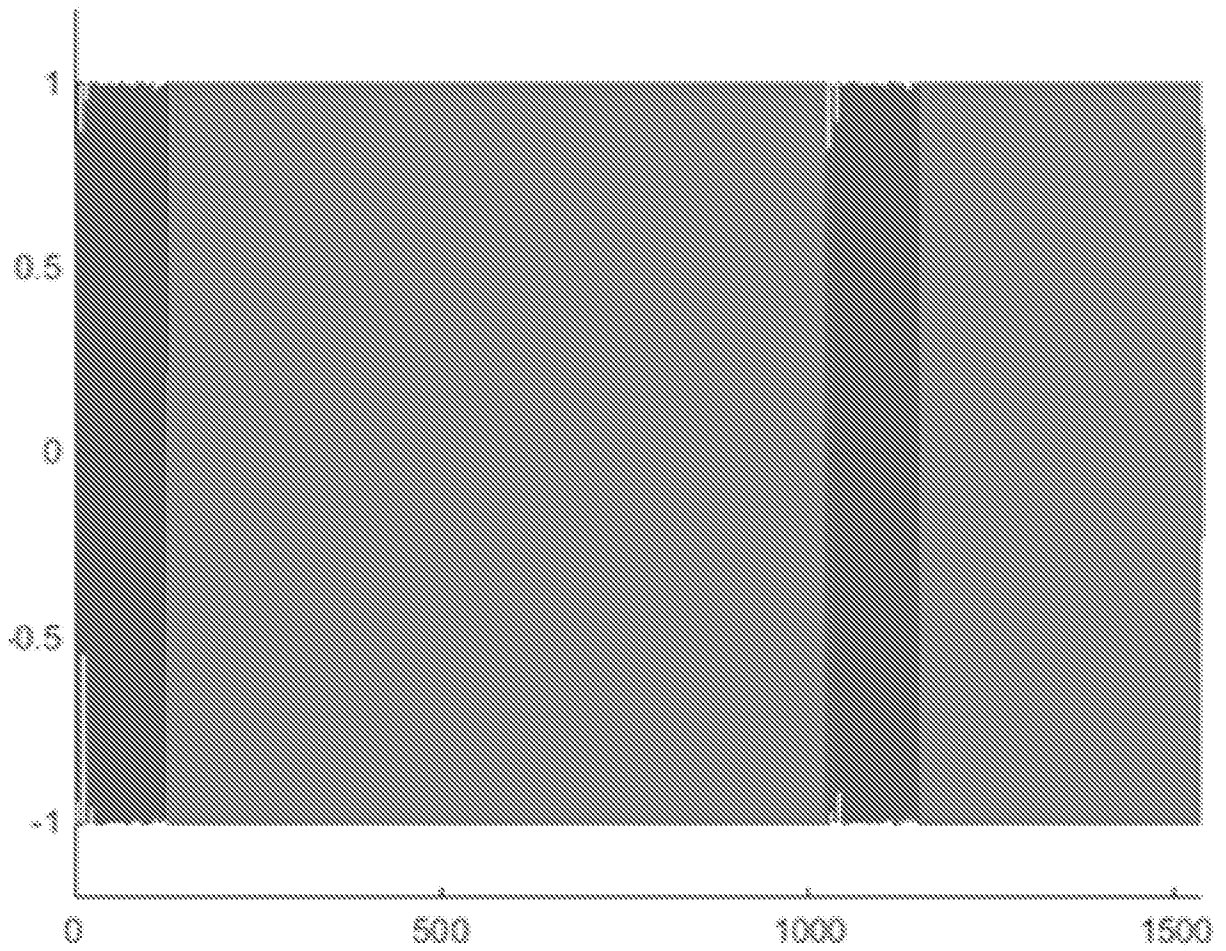

**FIG. 4(A)**

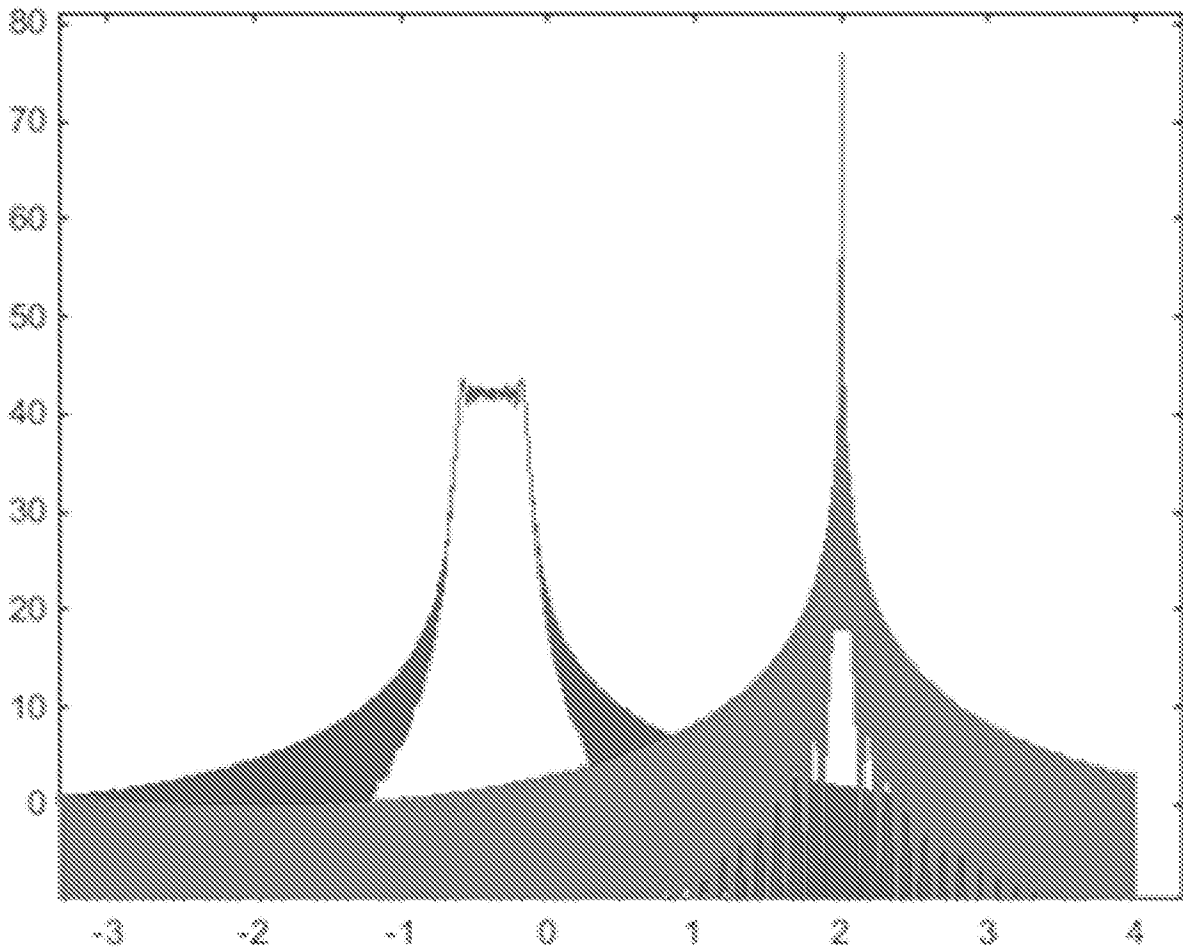

**FIG. 4(B)**

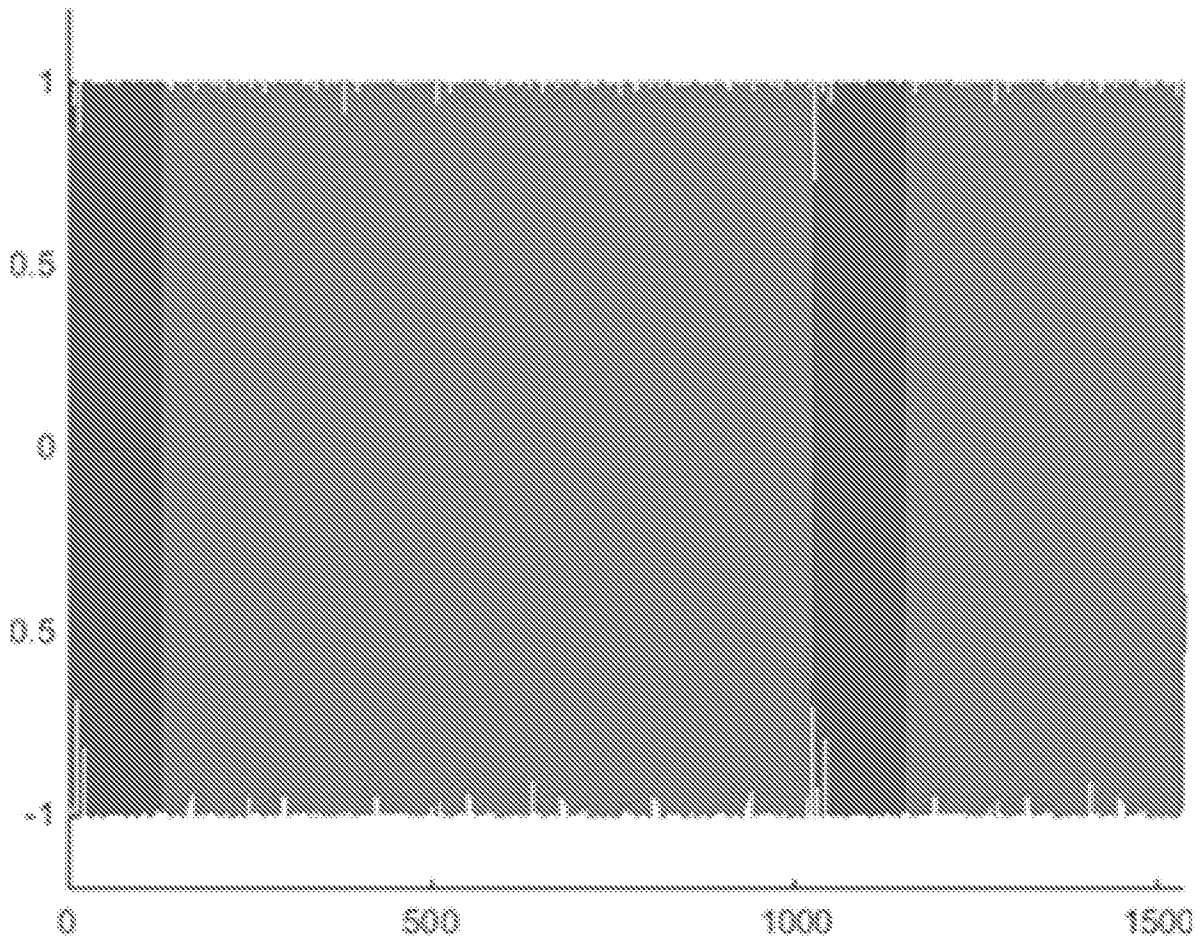

***FIG. 5(A)***

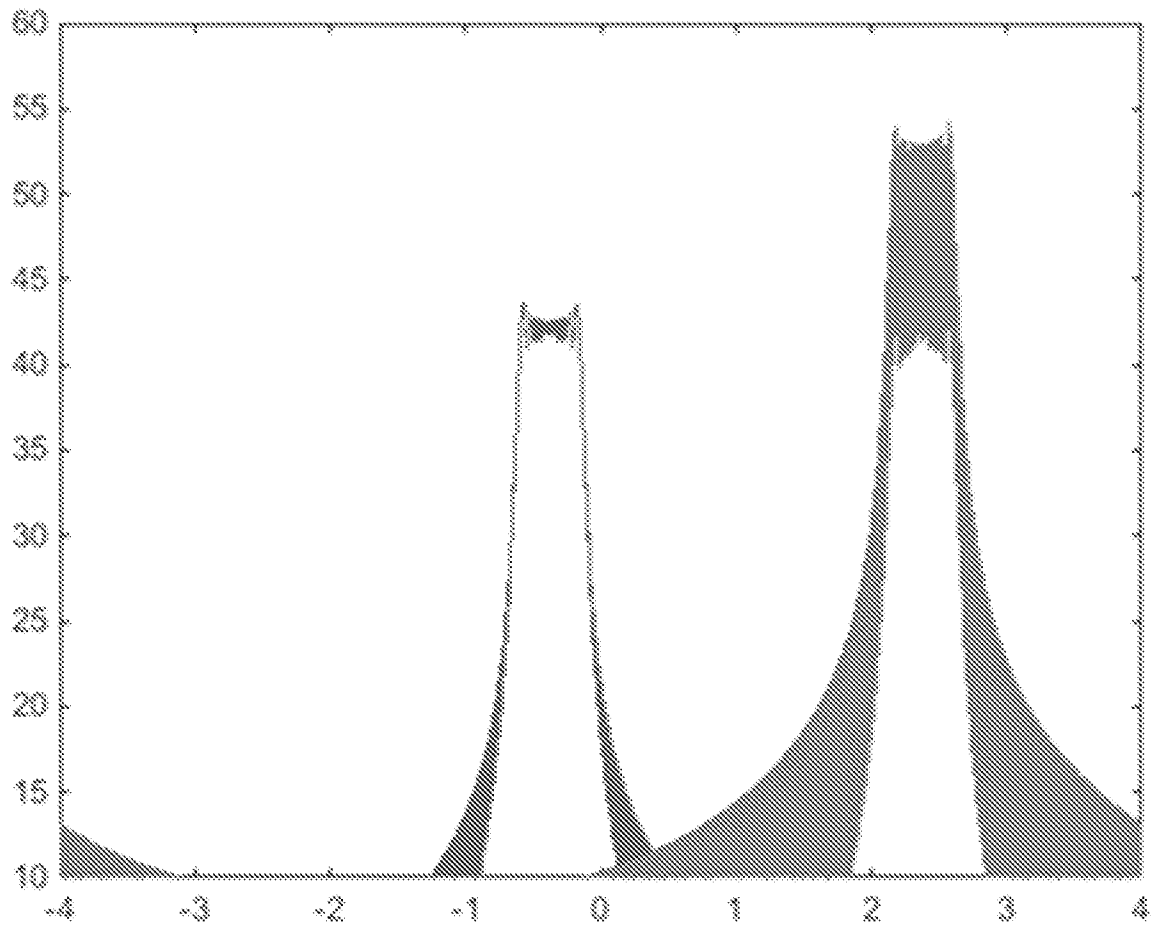

**FIG. 5(B)**



## INTERNATIONAL SEARCH REPORT

International application No.

PCT/US2021/026039

<b>A. CLASSIFICATION OF SUBJECT MATTER</b>		
<b>H04B 10/25(2013.01)i; H04B 10/075(2013.01)i; H04B 10/2537(2013.01)i</b>		
According to International Patent Classification (IPC) or to both national classification and IPC		
<b>B. FIELDS SEARCHED</b>		
Minimum documentation searched (classification system followed by classification symbols) H04B 10/25(2013.01); G01D 5/26(2006.01); G01D 5/353(2006.01); G01H 9/00(2006.01); G01M 11/00(2006.01)		
Documentation searched other than minimum documentation to the extent that such documents are included in the fields searched Korean utility models and applications for utility models Japanese utility models and applications for utility models		
Electronic data base consulted during the international search (name of data base and, where practicable, search terms used) eKOMPASS(KIPO internal) & keywords: coded distributed fiber optic sensing, interrogator, code sequence, out-of-band signal, analyzer		
<b>C. DOCUMENTS CONSIDERED TO BE RELEVANT</b>		
Category*	Citation of document, with indication, where appropriate, of the relevant passages	Relevant to claim No.
A	US 2019-0025094 A1 (OPTASENSE HOLDINGS LIMITED) 24 January 2019 (2019-01-24) paragraphs [0050]-[0140]; and figures 1-8	1-7
A	ZHISHENG YANG et al., 'Design rules for optimizing unipolar coded Brillouin optical time-domain analyzers', Optics Express Vol. 26, Issue 13, pp. 16505-16523, 25 June 2018 sections 3-5; and figure 3	1-7
A	MARCELO A. SOTO et al., 'Bipolar optical pulse coding for performance enhancement in BOTDA sensors', Optics Express Vol. 21, Issue 14, pp. 16390-16397, 02 July 2013 sections 2-3; and figures 2-3	1-7
A	EP 3460441 A1 (NOKIA SOLUTIONS AND NETWORKS OY et al.) 27 March 2019 (2019-03-27) paragraphs [0018]-[0103]; and figures 1-7	1-7
A	US 2017-0052041 A1 (AIQ DIENSTLEISTUNGEN UG (HAFTUNGSBESCHR NKT)) 23 February 2017 (2017-02-23) paragraphs [0082]-[0117]; and figures 1-7	1-7
<input type="checkbox"/> Further documents are listed in the continuation of Box C. <input checked="" type="checkbox"/> See patent family annex.		
* Special categories of cited documents: "A" document defining the general state of the art which is not considered to be of particular relevance "D" document cited by the applicant in the international application "E" earlier application or patent but published on or after the international filing date "L" document which may throw doubts on priority claim(s) or which is cited to establish the publication date of another citation or other special reason (as specified) "O" document referring to an oral disclosure, use, exhibition or other means "P" document published prior to the international filing date but later than the priority date claimed "T" later document published after the international filing date or priority date and not in conflict with the application but cited to understand the principle or theory underlying the invention "X" document of particular relevance; the claimed invention cannot be considered novel or cannot be considered to involve an inventive step when the document is taken alone "Y" document of particular relevance; the claimed invention cannot be considered to involve an inventive step when the document is combined with one or more other such documents, such combination being obvious to a person skilled in the art "&" document member of the same patent family		
Date of the actual completion of the international search <b>21 July 2021</b>		Date of mailing of the international search report <b>22 July 2021</b>
Name and mailing address of the ISA/KR <b>Korean Intellectual Property Office 189 Cheongsa-ro, Seo-gu, Daejeon 35208, Republic of Korea</b> Facsimile No. +82-42-481-8578		Authorized officer <b>YANG, JEONG ROK</b> Telephone No. +82-42-481-5709

**INTERNATIONAL SEARCH REPORT**  
**Information on patent family members**

International application No.

**PCT/US2021/026039**

Patent document cited in search report			Publication date (day/month/year)	Patent family member(s)			Publication date (day/month/year)
US	2019-0025094	A1	24 January 2019	CN	108139265	A	08 June 2018
				EP	3344958	A1	11 July 2018
				EP	3344958	B1	31 March 2021
				GB	201515505	D0	14 October 2015
				US	10495491	B2	03 December 2019
				WO	2017-037453	A1	09 March 2017
EP	3460441	A1	27 March 2019	EP	3460441	B1	29 July 2020
US	2017-0052041	A1	23 February 2017	DE	102015113581	A1	23 February 2017
				DE	102015113581	B4	04 February 2021
				EP	3141880	A1	15 March 2017
				EP	3141880	B1	14 November 2018
				US	10209100	B2	19 February 2019