

(19) 世界知的所有権機関
国際事務局



(43) 国際公開日
2002年10月31日 (31.10.2002)

PCT

(10) 国際公開番号
WO 02/085822 A1

(51) 国際特許分類: C07C 13/62, 211/54, 211/61, C09K 11/06, C07D 213/06, 333/08, 333/76, H05B 33/14, 33/22

(21) 国際出願番号: PCT/JP02/03925

(22) 国際出願日: 2002年4月19日 (19.04.2002)

(25) 国際出願の言語: 日本語

(26) 国際公開の言語: 日本語

(30) 優先権データ:
特願2001-121788 2001年4月19日 (19.04.2001) JP

(71) 出願人: ティーディーケイ株式会社 (TDK CORPORATION) [JP/JP]; 〒103-8272 東京都中央区日本橋一丁目13番1号 Tokyo (JP).

ケイ株式会社内 Tokyo (JP). 北川 寿美子 (KITAGAWA, Sumiko); 〒103-8272 東京都中央区日本橋一丁目13番1号 ティーディーケイ株式会社内 Tokyo (JP). 井上 鉄司 (INOUE, Tetsushi); 〒103-8272 東京都中央区日本橋一丁目13番1号 ティーディーケイ株式会社内 Tokyo (JP).

(74) 代理人: 石井 陽一 (ISHII, Yoichi); 〒113-0034 東京都文京区湯島3丁目23番1号 天神弥栄興産ビル3階 Tokyo (JP).

(81) 指定国 (国内): CN, KR.

(84) 指定国 (広域): ヨーロッパ特許 (AT, BE, CH, CY, DE, DK, ES, FI, FR, GB, GR, IE, IT, LU, MC, NL, PT, SE, TR).

添付公開書類:
— 国際調査報告書

(72) 発明者: 藤田 徹司 (FUJITA, Tetsuji); 〒103-8272 東京都中央区日本橋一丁目13番1号 ティーディー

2文字コード及び他の略語については、定期発行される各PCTガゼットの巻頭に掲載されている「コードと略語のガイダンスノート」を参照。

(54) Title: COMPOUND FOR ORGANIC EL ELEMENT AND ORGANIC EL ELEMENT

(54) 発明の名称: 有機EL素子用化合物、有機EL素子

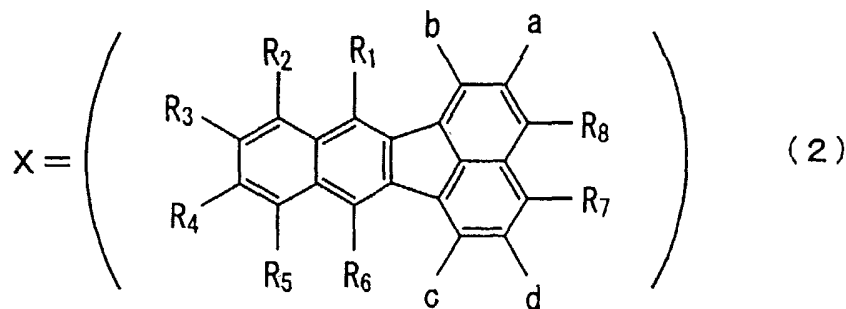

(57) Abstract: A compound for organic EL elements which is represented by the following formula (1). It retains such excellent durability that its excellent color purity and satisfactory luminescent performance last over long. Xn-Y (1) In the formula, X represents a group represented by the following formula (2), Y represents a single bond or connecting group, and n is 2 or 3: (2) wherein R1 to R8 and a to d each represents hydrogen, alkyl, aryl, allyl, a heterocyclic group, amino, or arylamino.

[続葉有]



WO 02/085822 A1



(57) 要約:

本発明は優れた色純度かつ良好な発光性能が長期にわたり持続する耐久性に優れた下記式(1)で表される有機EL素子用化合物および有機EL素子を提供することを目的とする。



[式中、Xは下記式(2)で表される基、Yは単結合または連結基、nは2または3を表す。]

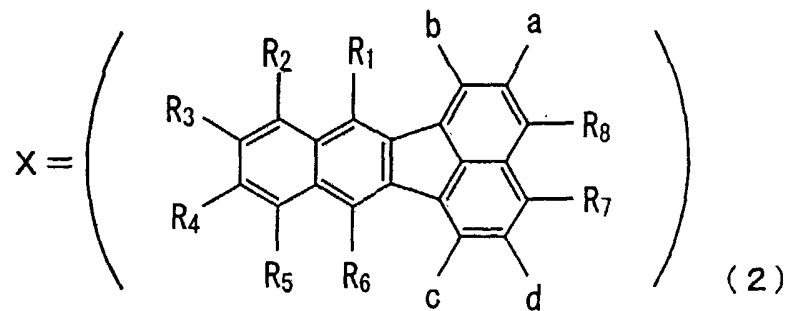

[式中、R₁~R₈、a~dは水素、アルキル基、アリール基、アリル基、複素環基、アミノ基、アリールアミノ基を表す。]

明 細 書

有機EL素子用化合物、有機EL素子

5 技術分野

本発明は、有機EL（電界発光）素子に関し、詳しくは、有機化合物からなる薄膜に電界を印加して光を放出する素子に用いられる化合物に関する。

背景技術

- 10 有機EL素子は、蛍光性有機化合物を含む薄膜を、電子注入電極とホール注入電極とで挟んだ構成を有し、前記薄膜に電子およびホールを注入して再結合させることにより励起子（エキシトン）を生成させ、このエキシトンが失活する際の光の放出（蛍光・燐光）を利用して発光する素子である。

- 有機EL素子の特徴は、10V前後の電圧で数100から数10000cd/m²
15 ときわめて高い輝度の面発光が可能であり、また蛍光物質の種類を選択することにより青色から赤色までの発光が可能なことである。

- 有機EL素子の任意の発光色を得るための手法としてドーピング法があり、アントラセン結晶中に微量のテトラセンをドーピングすることで発光色を青色から緑色に変化させた報告(Jpn. J. Appl. Phys., 10,527(1971))がある。また積層構造
20 を有する有機薄膜EL素子においては、発光機能を有するホスト物質に、その発光に应答しホスト物質とは異なる発光を放出する蛍光色素をドーパントとして微量混入させて発光層を形成し、緑色から橙～赤色へ発光色を変化させた報告（特開昭63-264692号公報）がなされている。

- 黄～赤色の長波長発光に関しては、発光材料あるいはドーパント材料として、
25 赤色発振を行うレーザー色素（EPO281381号）、エキサイプレックス発

光を示す化合物（特開平2-255788号公報）、ペリレン化合物（特開平3-791号公報）、クマリン化合物（特開平3-792号公報）、ジシアノメチレン系化合物（特開平3-162481号公報）、チオキサテン化合物（特開平3-177486号公報）、共役系高分子と電子輸送性化合物の混合物（特開平6-73374号公報）、スクアリリウム化合物（特開平6-93257号公報）、オキサジアゾール系化合物（特開平6-136359号公報）、オキシネイト誘導体（特開平6-145146号公報）、ピレン系化合物（特開平6-240246号公報）がある。

また、ベンゾフルオランラン誘導体が非常に高い蛍光量子収率を有することは、
10 J. Am. Chem. Soc. 1996, 118, 2374-2379に記載されており、特開平10-330295号公報および特開平11-233261号公報では種々のホスト材料にベンゾフルオランテンより誘導されるジベンゾ [f, f'] ジインデノ [1, 2, 3-cd : 1', 2', 3' -lm] ペリレン誘導体をドーピングして発光層とした有機EL素子を開示している。

15 他の発光材料として縮合多環芳香族化合物（特開平5-32966号公報、特開平5-214334号公報）も開示されている。またドーパント材料としても種々の縮合多環芳香族化合物（特開平5-258859号公報）が提案されている。

しかしながら、これら従来の蛍光材料では純青に近い発光色が得られた例は極めて少なく、高品位のフルカラーディスプレイを実現する上でも、高効率の純青系蛍光材料が望まれていた。

発明の開示

本発明の目的は、十分な輝度の発光、特に長波長における発光が得られ、優れた色純度、特にフルカラーディスプレイに用いるのに十分な色純度が得られ、か
25

つ良好な発光性能が長期にわたって持続する耐久性に優れた有機EL素子用化合物、および有機EL素子を提供することである。

上記目的は、以下の構成により達成される。

(1) 下記式(1)で表される基本骨格を有する有機EL素子用化合物。



[式(1)中、Xは下記式(2)で表される化合物を表し、同一であっても異なってもよい。Yは単結合もしくは置換または非置換のアリール基、または複素環基からなる連結基を表し、nは2または3の整数を表す。]

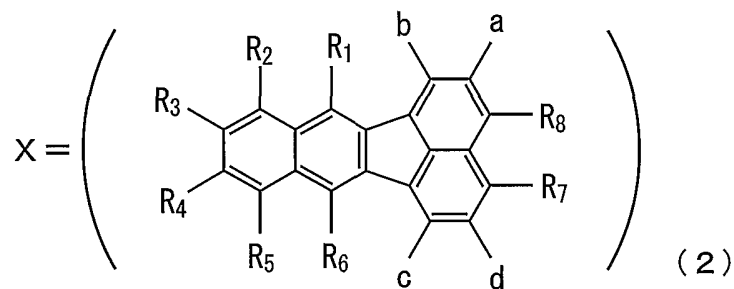

10 [式(2)中、 $R_1 \sim R_8$ および a ~ d は水素、アルキル基、置換基を有しているもよいアリール基、置換基を有しているもよいアリル基、置換基を有しているもよい複素環基、アミノ基、または置換基を有しているもよいアリールアミノ基のいずれかを表す。]

15 (2) 前記 Y は下記化合物より選択される 1 種である (1) の有機 EL 素子用化合物。

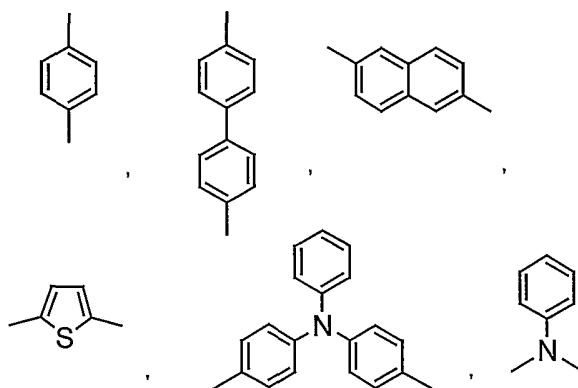

(3) 前記 n は 2 である (1) または (2) の有機 EL 素子用化合物。

(4) ドーパントとして用いられる (1) ~ (3) のいずれかの有機 EL 素子用化合物。

(5) 電子輸送材料である (1) ~ (4) のいずれかの有機 EL 素子用化合物。

(6) ホール注入または輸送材料である (1) ~ (4) のいずれかの有機 EL 素子用化合物。

(7) 下記式 (3 a) で表される基本骨格を有する (1) ~ (6) のいずれかの有機 EL 素子用化合物。

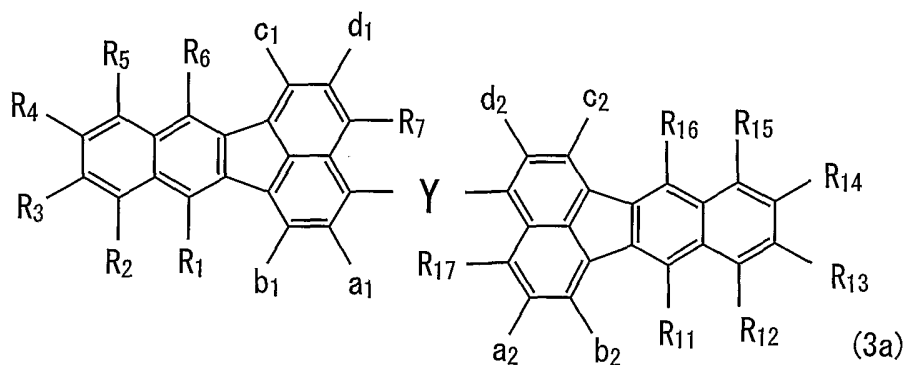

10

[式 (3 a) 中、 $R_1 \sim R_8$ および $a_1 \sim d_1$ 、 $R_{11} \sim R_{18}$ および $a_2 \sim d_2$ は、水素、アルキル基、置換基を有していてもよいアリール基、置換基を有していてもよいアリル基、置換基を有していてもよい複素環基、アミノ基、置換基を有していてもよいアリールアミノ基のいずれかを表す。Y は置換または非置換のフェニレン、ビフェニレン、ナフタセン、ペリレン、ピレン、フェナントレン、チオフェン、ピリジン、ピラジン、トリアジン、アミン、トリアリールアミン、ピロール誘導体、チアゾール、チアジアゾール、フェナントロリン、キノリン、およびキノキサリンのいずれかからなる連結基を表す。]

(8) 下記式 (3 b) で表される基本骨格を有する (1) ~ (6) のいずれかの有機 EL 素子用化合物。

20

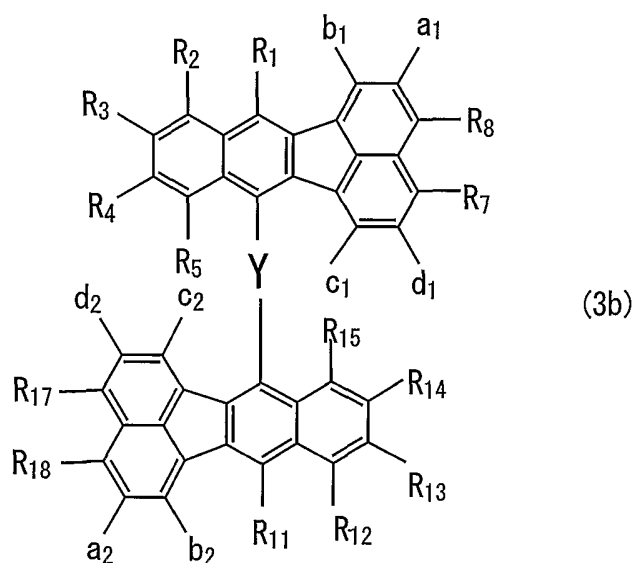

- 5 [式(3b)中、 $R_1 \sim R_8$ および $a_1 \sim d_1$ 、 $R_{11} \sim R_{18}$ および $a_2 \sim d_2$ は、水素、アルキル基、置換基を有していてもよいアリール基、置換基を有していてもよいアリル基、置換基を有していてもよい複素環基、アミノ基、置換基を有していてもよいアリールアミノ基のいずれかを表す。Yは単結合、置換または非置換のアリール基、あるいは複素環基からなる連結基を表す。]

(9) 下記式(3c)で表される基本骨格を有する(1)～(6)のいずれかの有機EL素子用化合物。

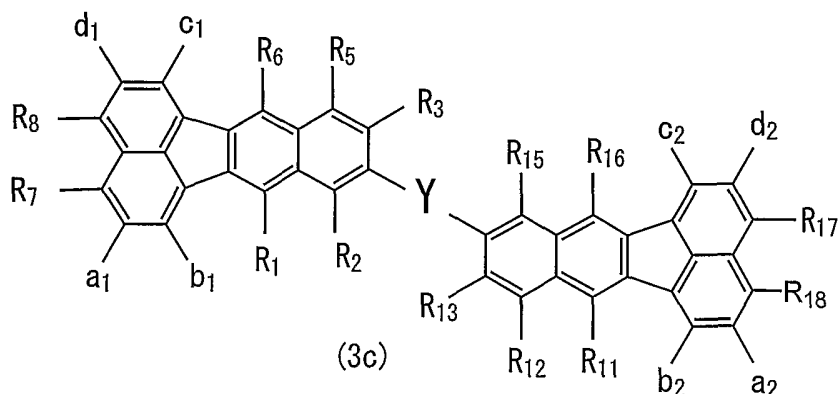

- 10 [式(3c)中、 $R_1 \sim R_8$ および $a_1 \sim d_1$ 、 $R_{11} \sim R_{18}$ および $a_2 \sim d_2$ は、水素、アルキル基、置換基を有していてもよいアリール基、置換基を有していてもよいアリル基、置換基を有していてもよい複素環基、アミノ基、置換基を

有していてもよいアリールアミノ基のいずれかを表す。Yは単結合、置換または非置換のアリール基、あるいは複素環基からなる連結基を表す。]

(10) 下記式(A)で表される基本骨格を有する(1)~(6)のいずれかの有機EL素子用化合物。

5

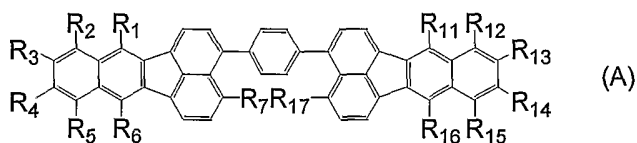

[式(A)中、R₁~R₇およびR₁₁~R₁₇は、水素、アルキル基、置換または非置換のアリール基、あるいは複素環基を表す。]

(11) 下記式(B)で表される基本骨格を有する(1)~(6)のいずれかの有機EL素子用化合物。

10

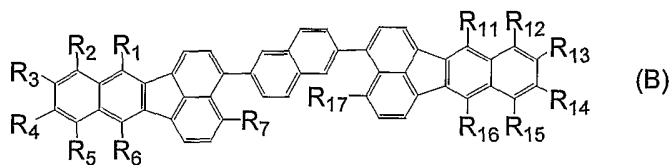

[式(B)中、R₁~R₇およびR₁₁~R₁₇は、水素、アルキル基、置換または非置換のアリール基、あるいは複素環基を表す。]

(12) 下記式(E)で表される基本骨格を有する(1)~(6)のいずれかの有機EL素子用化合物。

15

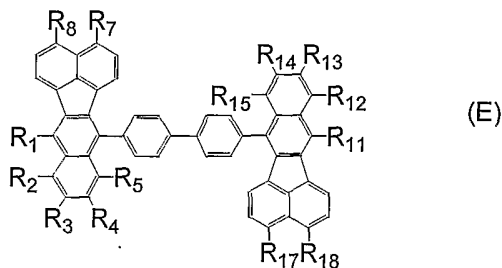

[式(E)中、R₁~R₈およびR₁₁~R₁₈は、水素、アルキル基、置換または非置換のアリール基、あるいは複素環基を表す。]

(13) 下記式 (H) で表される基本骨格を有する (1) ~ (6) のいずれかの有機 EL 素子用化合物。

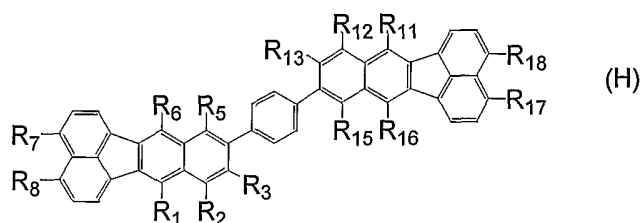

[式 (H) 中、 $R_1 \sim R_8$ および $R_{11} \sim R_{18}$ は、水素、アルキル基、置換または非置換のアリール基、あるいは複素環基を表す。]

(14) 下記式 (X) で表される基本骨格を有する (1) ~ (6) のいずれかの有機 EL 素子用化合物。

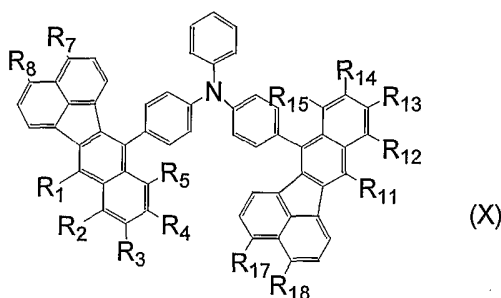

[式 (X) 中、 $R_1 \sim R_8$ および $R_{11} \sim R_{18}$ は、水素、アルキル基、置換または非置換のアリール基、あるいは複素環基を表す。]

(15) 下記式 (Z) で表される基本骨格を有する (1) ~ (6) のいずれかの有機 EL 素子用化合物。

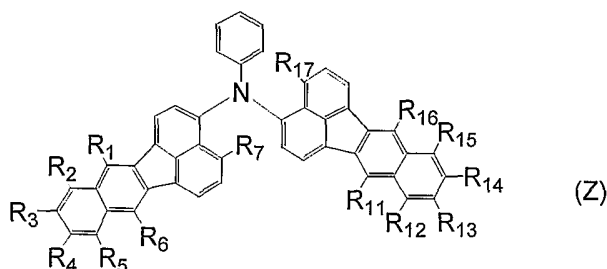

[式 (Z) 中、 $R_1 \sim R_7$ および $R_{11} \sim R_{17}$ は、水素、アルキル基、置換ま

たは非置換のアリール基、あるいは複素環基を表す。]

(16) 下記式(AAA')で表される基本骨格を有する(1)~(6)のいずれかの有機EL素子用化合物。

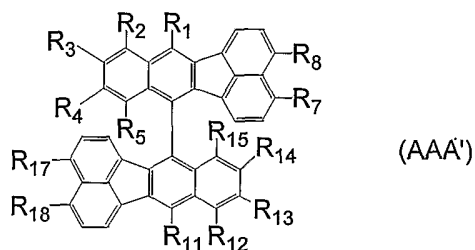

- 5 [式(AAA')中、 $R_1 \sim R_8$ 、および $R_{11} \sim R_{18}$ は、水素、アルキル基、置換基を有していてもよいアリール基、置換基を有していてもよいアリル基、置換基を有していてもよい複素環基、アミノ基、置換基を有していてもよいアリールアミノ基のいずれかを表す。]

- 10 (17) 下記式(BBB')で表される基本骨格を有する(1)~(6)のいずれかの有機EL素子用化合物。

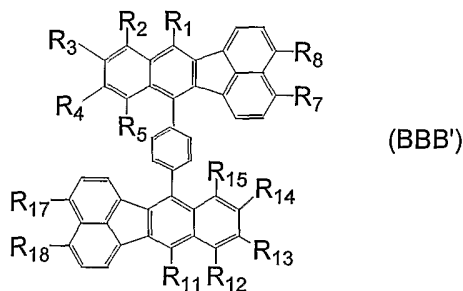

- 15 [式(BBB')中、 $R_1 \sim R_8$ 、および $R_{11} \sim R_{18}$ は、水素、アルキル基、置換基を有していてもよいアリール基、置換基を有していてもよいアリル基、置換基を有していてもよい複素環基、アミノ基、置換基を有していてもよいアリールアミノ基のいずれかを表す。]

(18) 下記式(CCC')で表される基本骨格を有する(1)~(6)のいずれかの有機EL素子用化合物。

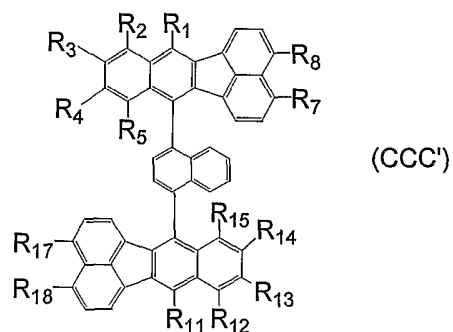

[式 (CCC') 中、 $R_1 \sim R_8$ 、および $R_{11} \sim R_{18}$ は、水素、アルキル基、置換基を有していてもよいアリール基、置換基を有していてもよいアリル基、置換基を有していてもよい複素環基、アミノ基、置換基を有していてもよいアリールアミノ基のいずれかを表す。]

(19) 下記式 (DDD') で表される基本骨格を有する (1) ~ (6) のいずれかの有機EL素子用化合物。

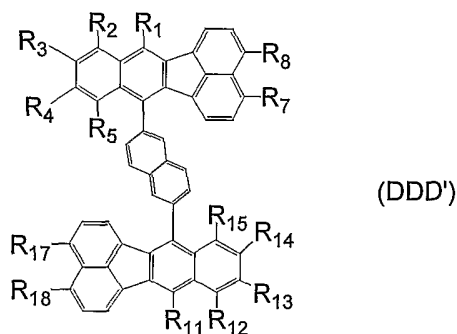

10

[式 (DDD') 中、 $R_1 \sim R_8$ 、および $R_{11} \sim R_{18}$ は、水素、アルキル基、置換基を有していてもよいアリール基、置換基を有していてもよいアリル基、置換基を有していてもよい複素環基、アミノ基、置換基を有していてもよいアリールアミノ基のいずれかを表す。]

15 (20) 下記式 (EEE') で表される基本骨格を有する (1) ~ (6) のいずれかの有機EL素子用化合物。

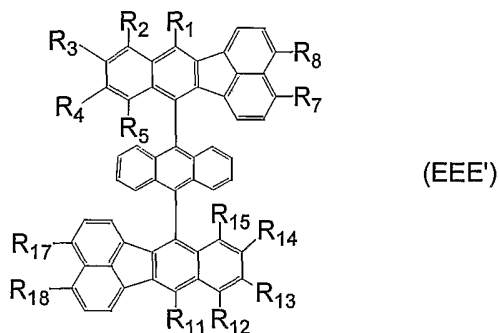

5 [式 (EEE') 中、 $R_1 \sim R_8$ 、および $R_{11} \sim R_{18}$ は、水素、アルキル基、置換基を有していてもよいアリール基、置換基を有していてもよいアリル基、置換基を有していてもよい複素環基、アミノ基、置換基を有していてもよいアリールアミノ基のいずれかを表す。]

(21) 下記式 (RRR') で表される基本骨格を有する (1) ~ (6) のいずれかの有機 EL 素子用化合物。

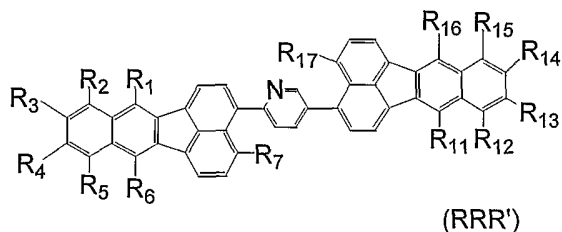

10 [式 (RRR') 中、 $R_1 \sim R_8$ 、および $R_{11} \sim R_{18}$ は、水素、アルキル基、置換基を有していてもよいアリール基、置換基を有していてもよいアリル基、置換基を有していてもよい複素環基、アミノ基、置換基を有していてもよいアリールアミノ基のいずれかを表す。]

15 (22) 下記式 (SSS') で表される基本骨格を有する (1) ~ (6) のいずれかの有機 EL 素子用化合物。

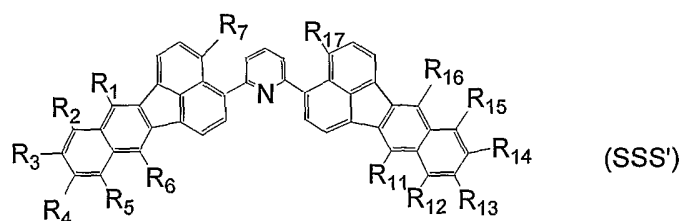

[式 (SSS') 中、 $R_1 \sim R_8$ 、および $R_{11} \sim R_{18}$ は、水素、アルキル基、置換基を有していてもよいアリール基、置換基を有していてもよいアリル基、置換基を有していてもよい複素環基、アミノ基、置換基を有していてもよいアリールアミノ基のいずれかを表す。]

(23) 一対の電極間に少なくとも発光機能に関与する1種または2種以上の有機層を有し、

前記有機層の少なくとも1層には(1)～(22)のいずれかの有機EL素子用化合物を1種又は2種以上含有する有機EL素子。

(24) 前記有機EL素子用化合物に加え、さらにアントラセン系化合物の1種又は2種以上含有する(23)の有機EL素子。

(25) 前記アントラセン誘導体を発光層のホスト材料として含有する(24)の有機EL素子。

(26) 前記有機EL素子用化合物をドーパントとして含有する(23)～(25)のいずれかの有機EL素子。

(27) 前記有機EL用化合物を発光層に含有する(23)～(26)のいずれかの有機EL素子。

(28) 前記有機EL用化合物を電子輸送層に含有する(23)～(25)のいずれかの有機EL素子。

(29) 前記有機EL素子用化合物をホール注入輸送層に含有する(23)～(28)のいずれかの有機EL素子。

(30) 2種以上の発光材料による2種以上の発光極大波長を有する(2

3) ~ (29) のいずれかの有機EL素子。

図面の簡単な説明

- 図1は、本発明の有機EL素子の基本構成を示す概略断面図である。
- 5 図2は、マスペクトルを示した図である。
- 図3は、赤外吸収スペクトルを示した図である。
- 図4は、NMRスペクトルを示した図である。
- 図5は、実施例1の素子の発光スペクトルを示した図である。
- 図6は、実施例11の素子の発光スペクトルを示した図である。
- 10 図7は、実施例12の素子の発光スペクトルを示した図である。
- 図8は、実施例13の素子の発光スペクトルを示した図である。

発明を実施するための最良の形態

- 本発明の有機EL素子用化合物は、下記式(1)で表される基本骨格を有する
- 15 ものである。



[式(1)中、Xは下記式(2)で表される化合物を表し、同一であっても異なってもよい。Yは単結合もしくは置換または非置換のアリール基、または複素環基からなる連結基を表し、nは2または3の整数を表す。]

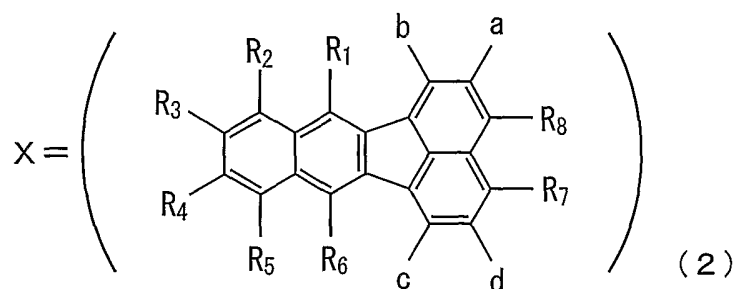

20

[式(2)中、R₁ ~ R₈ および a ~ d は、水素、アルキル基、置換基を有し

ていてもよいアリール基、置換基を有していてもよいアリル基、置換基を有していてもよい複素環基、アミノ基、または置換基を有していてもよいアリールアミノ基のいずれかを表す。]

上記式(1)で表される化合物についてさらに詳述する。

- 5 式(1)中、Xは上記式(2)で表される化合物を表し、各Xは同一であっても異なってもよい。すなわち、Xは上記式(2)で表される化合物であればそれぞれ同一の化合物であっても異なった化合物であってもよいが、同一であることが好ましい。n=3のとき、3種のXがそれぞれ異なってもよい。

式(2)において、 $R_1 \sim R_8$ および a~d は、水素、アルキル基、置換基を有していてもよいアリール基、置換基を有していてもよいアリル基、置換基を有していてもよい複素環基、アミノ基、置換基を有していてもよいアリールアミノ基のいずれかを表す。また、好ましくは、メチル基、エチル基、プロピル基、フェニル基、トリル基、ビフェニル基、ナフチル基、チオフェニル基、ピリジル基、ピロール基、スチリル基、トリフェニルアミノ基、フェニルアミノ基のいずれか
10 であり、特にメチル基、フェニル基、トリル基、ビフェニル基、ナフチル基、トリフェニルアミノ基、フェニルアミノ基のいずれかが好ましい。

$R_1 \sim R_8$ および a~d は、それぞれ同一でも異なってもよい。また、隣り合う $R_1 \sim R_8$ および a~d の間で縮合環を形成していてもよい。

特に、 R_7 、 R_8 の部位は、構造的に反応活性が高いため、置換基を有することが好ましい。 R_7 、 R_8 の部位を置換基でマスクすることにより、化合物を化学的に安定にし、EL発光時の材料の劣化を防止することができる。 R_7 、 R_8 は、少なくともどちらか一方に置換基を有することが好ましく、特に双方に置換基を有することが好ましい。

R_7 、 R_8 の置換基としては、上記で例示したものが挙げられるが、特に、アルキル基、アリール基、アリル基、複素環基が好ましい。
25

また、 R_7 、 R_8 に導入する置換基の種類により、発光波長が敏感に影響を受ける。このため、 R_7 、 R_8 に導入する置換基を選択することで、発光波長をコントロールすることもできる。

X の数を表す n は、2または3の整数であり、好ましくは $n=2$ である。 $n=3$ になると、昇華性が低下し、昇華時の熱分解などが起こり、また化合物の安定性が若干低下してくる。一方、 $n=1$ では結晶化しやすく、青紫外発光となりやすく、EL発光させることが難しくなる。

式(1)中、 Y は単結合もしくは置換または非置換のアリール基、または複素環基からなる連結基を表す。好ましくは、 Y が R_7 と R_7 、 R_8 と R_8 または R_7 と R_8 の位置の組み合わせで結合するとき、単結合および下記式(11)、(12)で表される結合位置のナフタレンおよびアントラセン化合物は含まない。

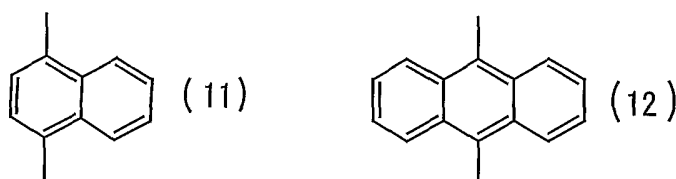

X 同士の連結位置としては、特に限定されるものではなく X のいずれの位置でも、連結基のいずれの炭素で連結していてもよい。すなわち、上記式(2)で表される基本骨格のうち、 $R_1 \sim R_8$ および $a \sim d$ のいずれの位置であってもかまわなが、好ましくは $R_1 \sim R_8$ から選択されるいずれかの部位であり、特に R_1 、 R_6 、 R_7 、および R_8 のいずれかの部位である。

また、好ましくは、 Y が R_7 、 R_8 の位置で結合する場合には、単結合の場合、つまり X どうしが直接結合する場合、および上記結合部位でのナフタレンおよびアントラセン結合基は含まない。 R_7 、 R_8 の位置で X 同士が直接連結すると、昇華精製時の熱的安定性、およびEL発光時の電気化学的安定性が不安定となり、 R_7 、 R_8 の2カ所(対象位置)で結合したりする。

特に、 Y は置換または非置換のフェニレン、ビフェニレン、ナフタセン、ペリ

- レン、ピレン、フェナントレン、チオフェン、ピリジン、ピラジン、トリアジン、アミン、トリアリールアミン、ピロール誘導体、チアゾール、チアジアゾール、フェナントロリン、キノリン、およびキノキサリンのいずれかからなる連結基が好ましく、特に置換または非置換のベンゼン、テトラセン、ペリレン、ピレン、
- 5 複素環基のいずれかが好ましい。さらに、下記の化合物から選択される1種の連結基が好ましい。

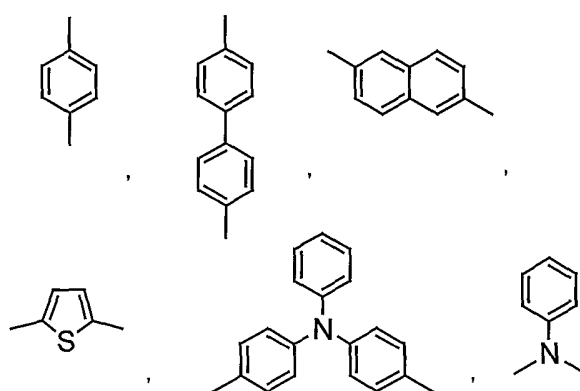

Xは、好ましくは下記式(3a)、(3b)、(3c)で表される化合物である。

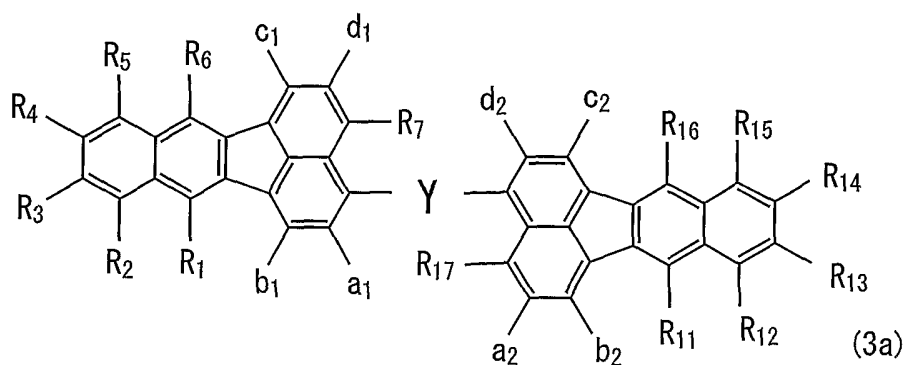

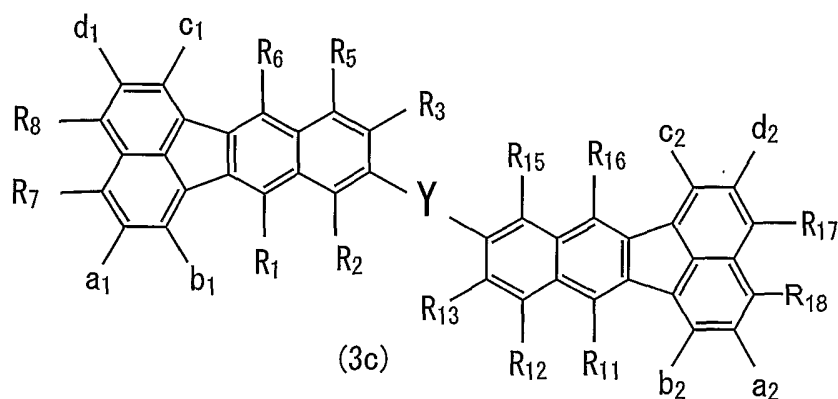
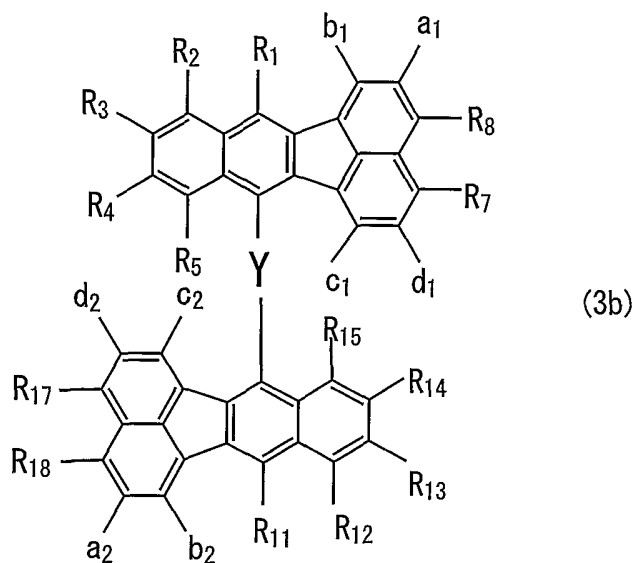

式 (3 a) ~ (3 c) において、 $R_1 \sim R_8$ および $a_1 \sim d_1$ 、 $R_{11} \sim R_{18}$ および $a_2 \sim d_2$ は、式 (2) における $R_1 \sim R_8$ および $a \sim d$ と同義である。式
 5 (3 a) ~ (3 c) のなかでは式 (3 a) で表されるものが最も好ましく、次いで式 (3 b) で表されるものが好ましい。

本発明の化合物は、イオン化ポテンシャルの絶対値が 5.9 eV より小さいことが好ましく、特に 5.8 eV 以下、さらに 5.7 eV 以下であるとよい。イオン化ポテンシャルの絶対値が 5.9 eV より小さいと、イオン化ポテンシャルの絶対値が 5.9 eV 程度の化合物との組み合わせ、特にアントラセンダイマーとの
 10 組み合わせにおいて良好な発光が得られるようになる。その下限としては特に限定されるものではないが、通常 5.2 eV 程度である。

本発明の化合物は、塩化メチレン溶液中、白金電極において半波酸化電位が 1.5V 以下であることが好ましく、特に 1.4V 以下、さらには 1.3V 以下であるとよい。酸化電位が上記値以下であると、安定性が増し、素子の寿命が延びる。また、上記イオン化ポテンシャルと同様の効果が得られる。その下限として

5 は特に限定されるものではないが、通常 0.4V 程度である。

本発明の化合物の好ましい例を以下に示す。

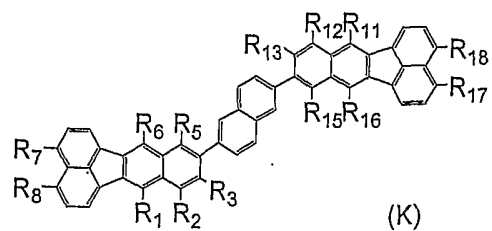
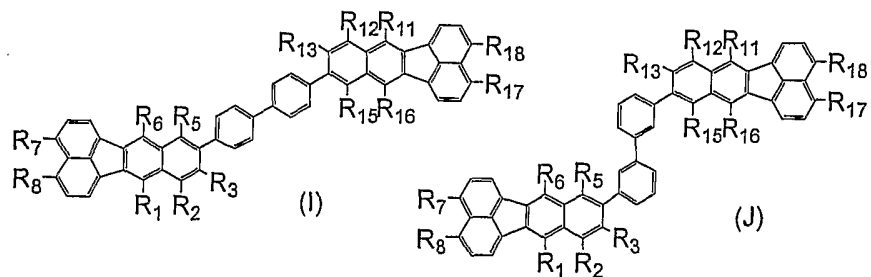
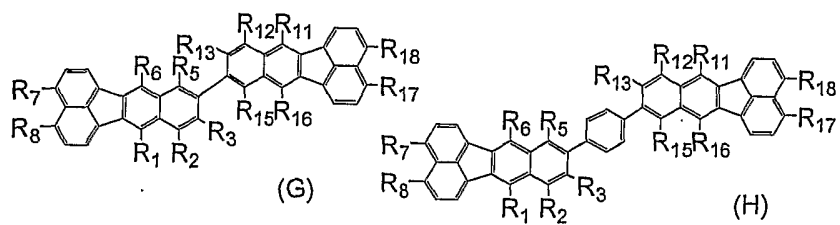
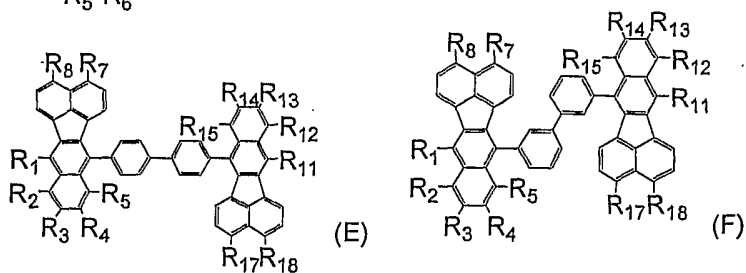
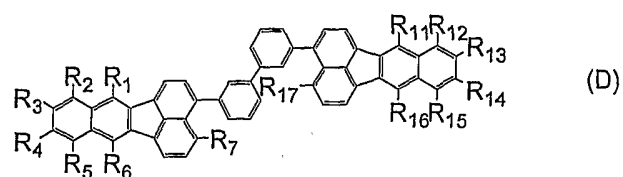
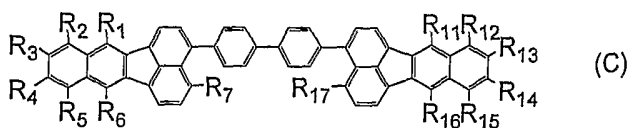
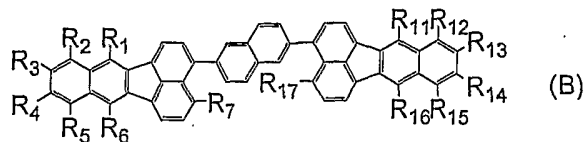
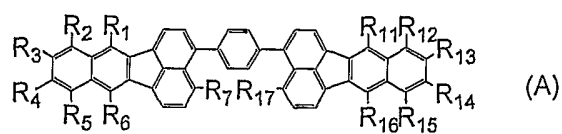

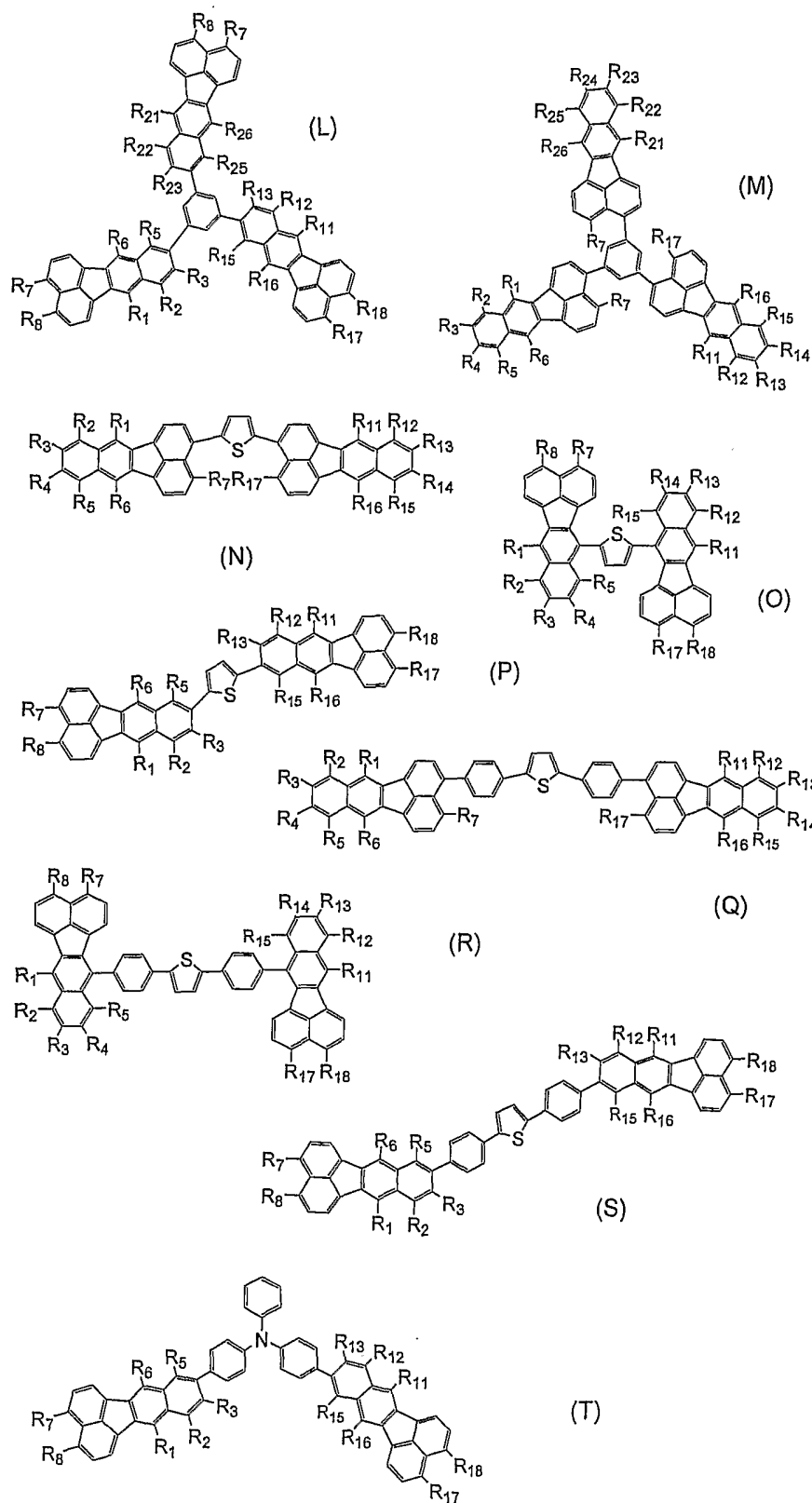

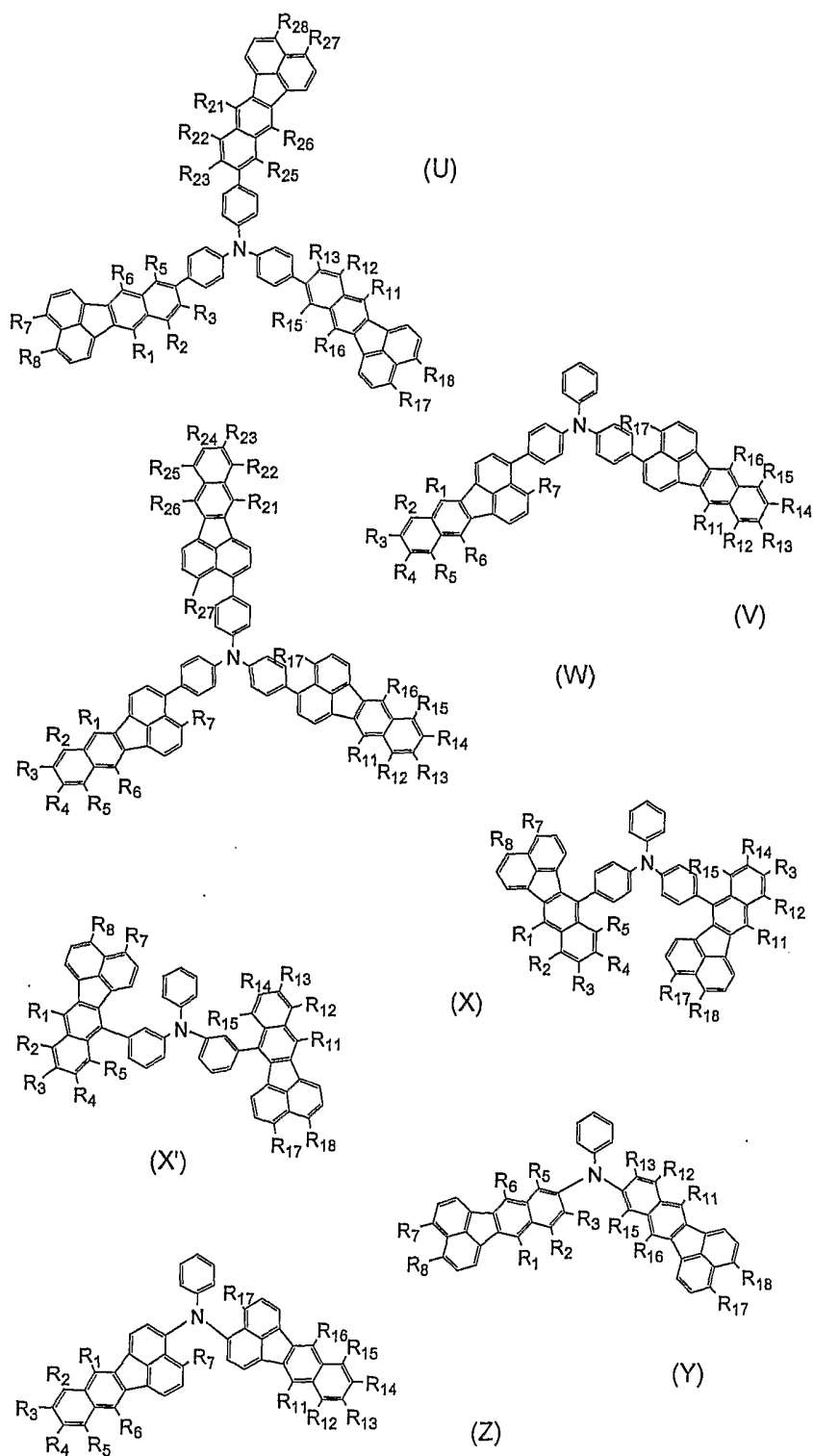

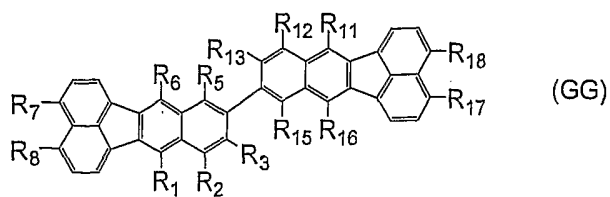
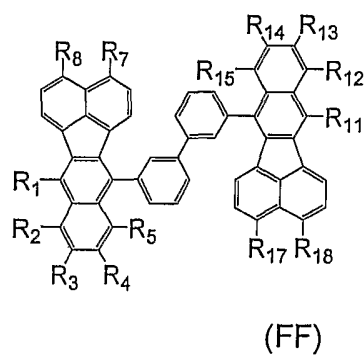
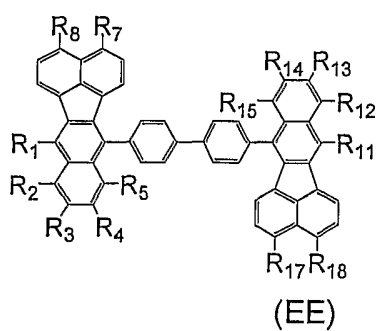
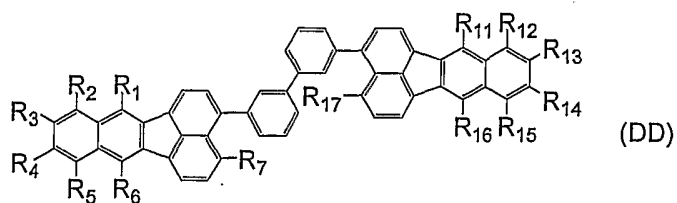
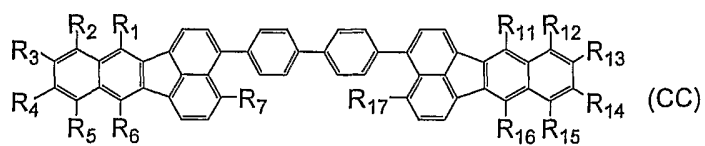
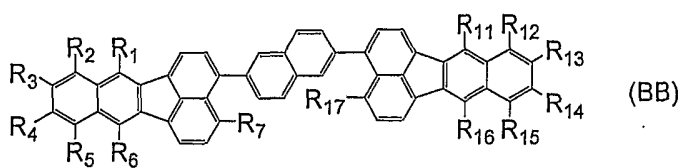
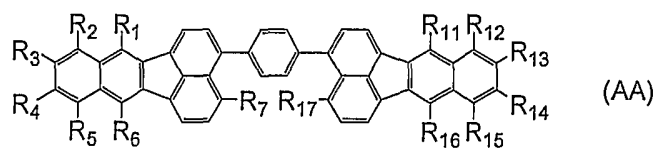

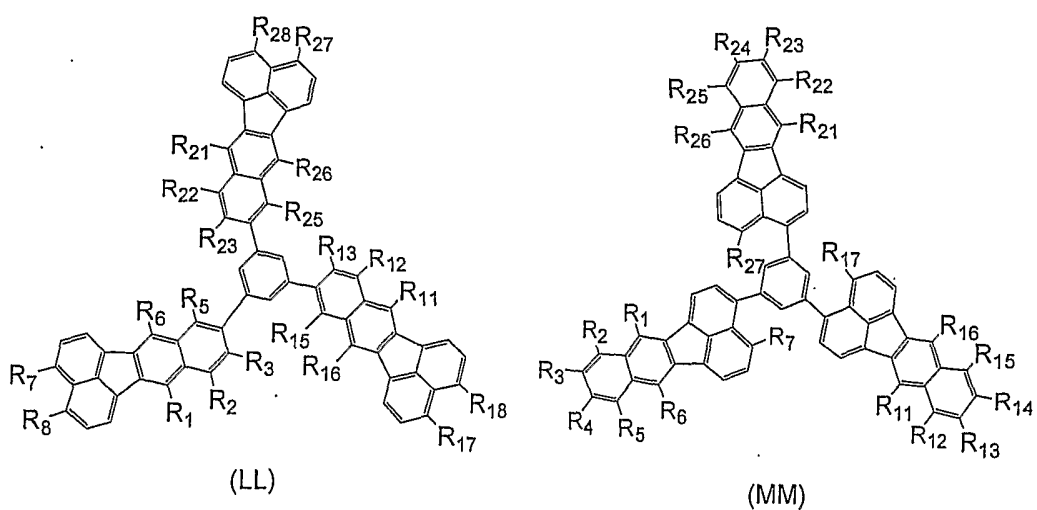
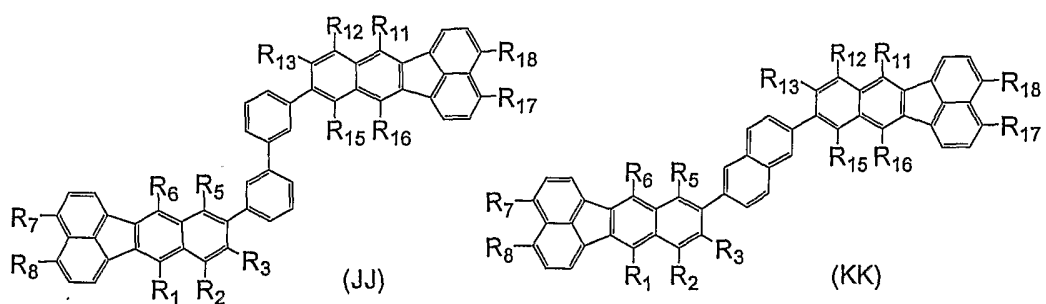
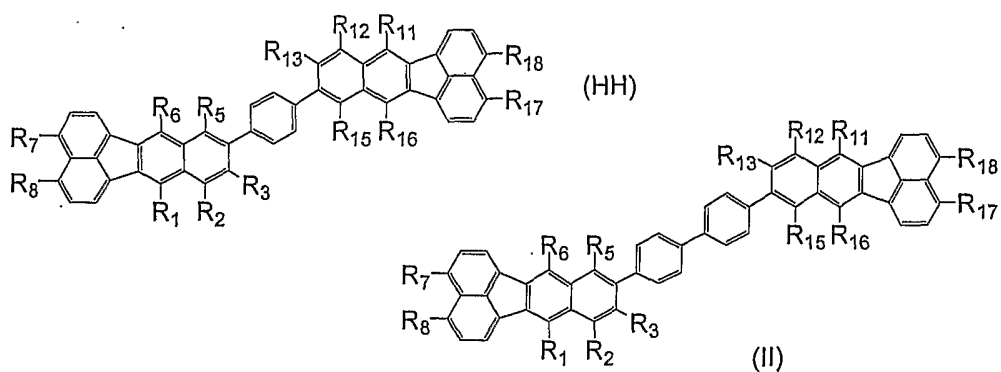

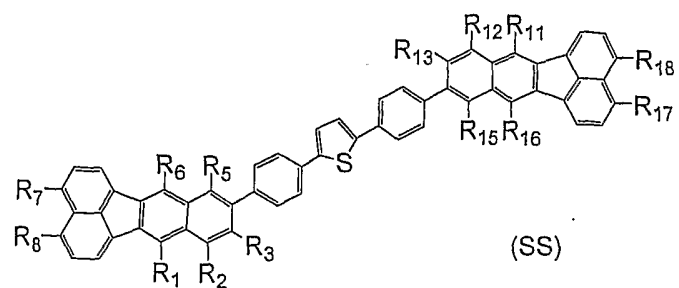
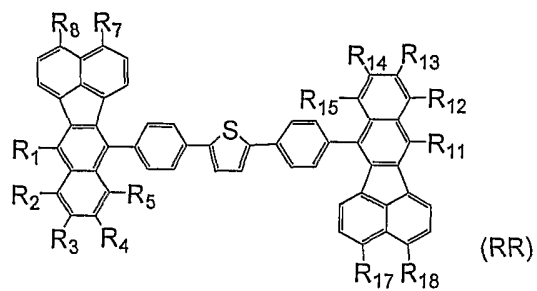
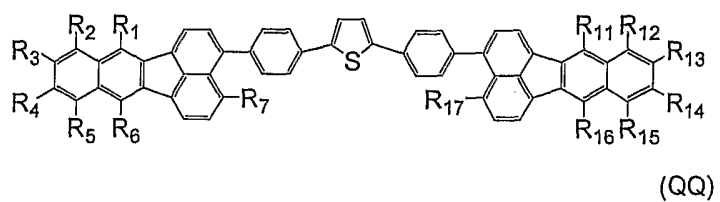
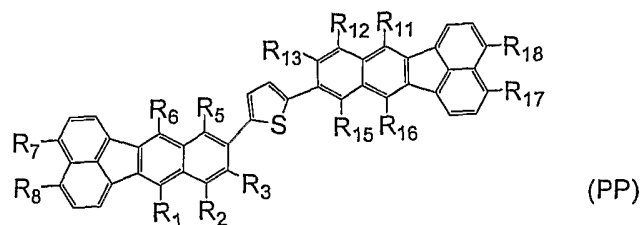
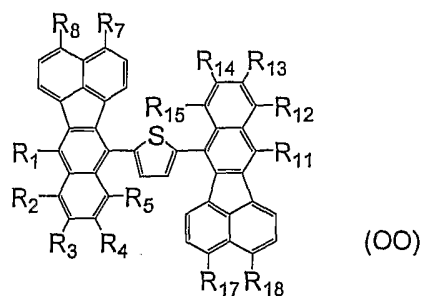

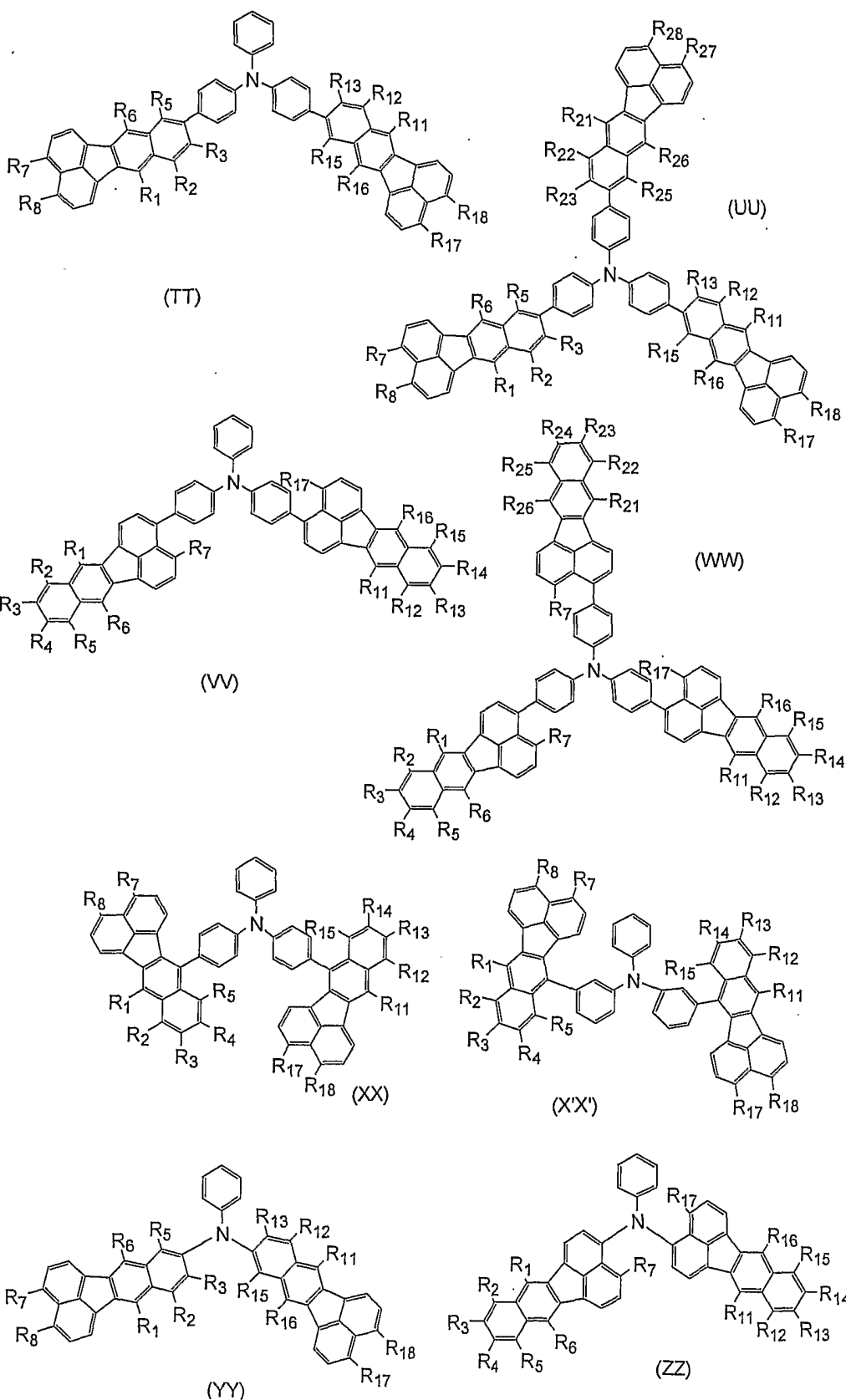

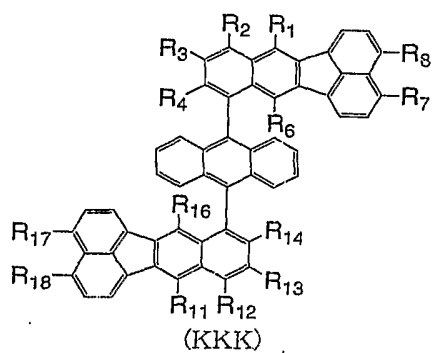
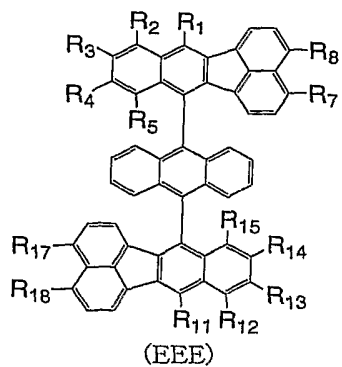
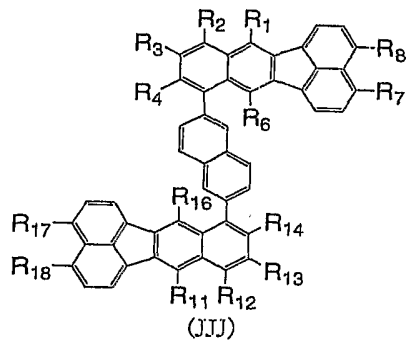
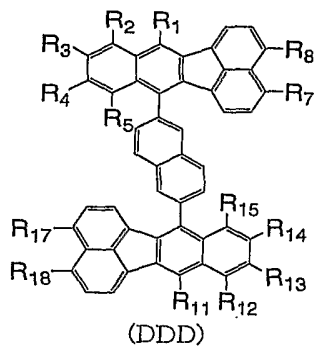
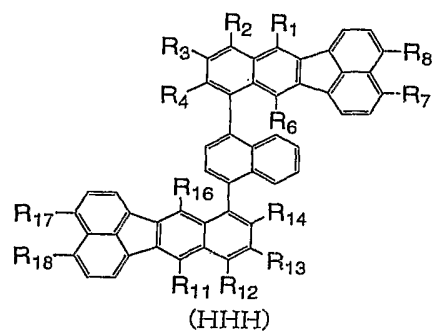
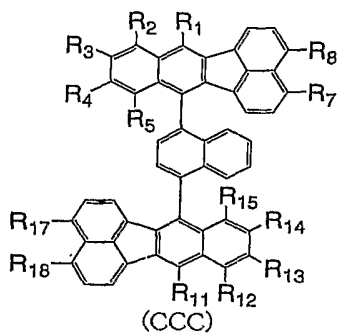
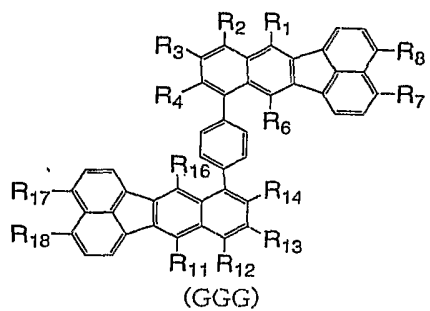
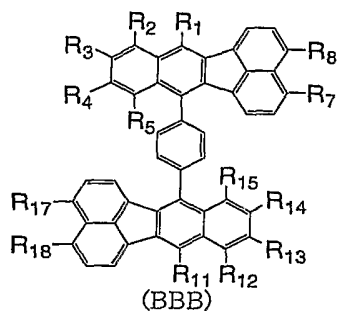
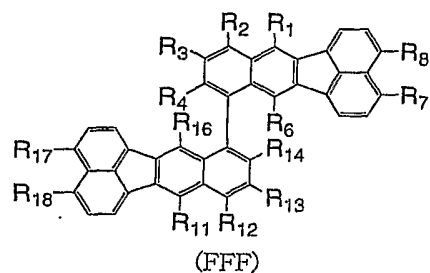
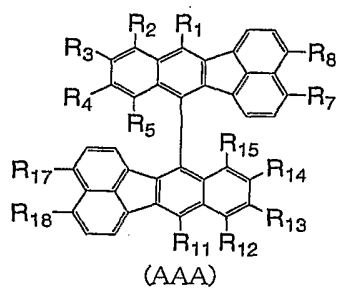

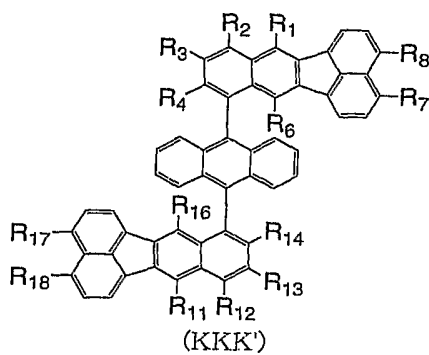
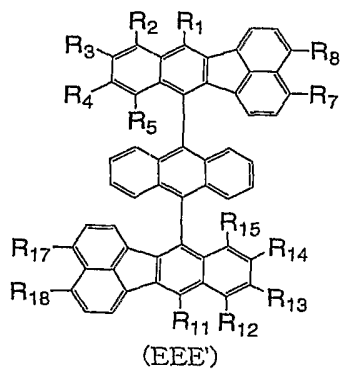
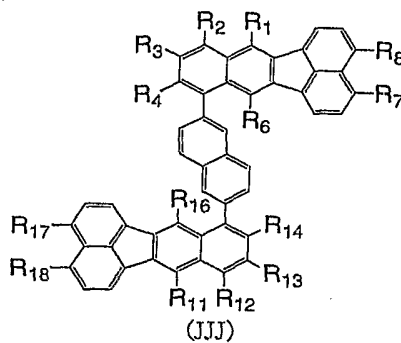
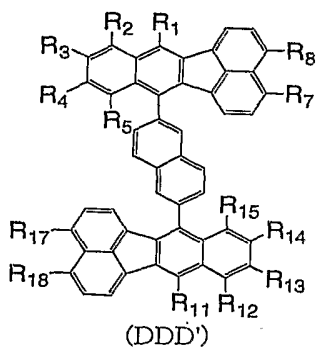
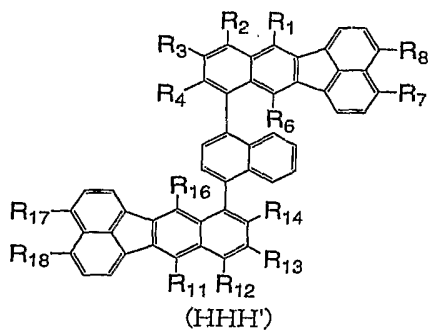
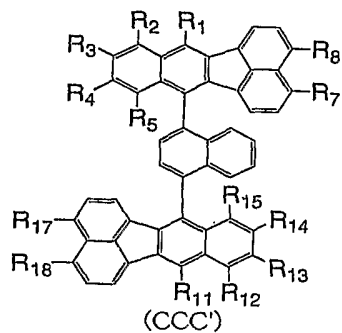
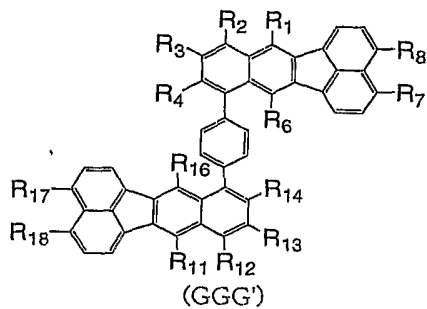
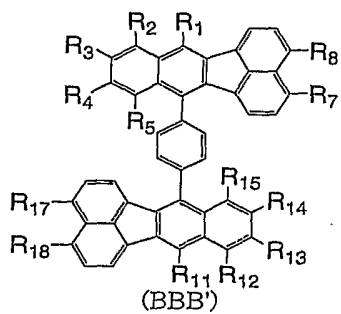
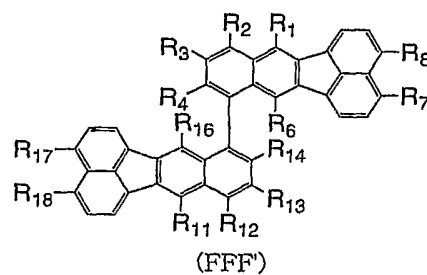
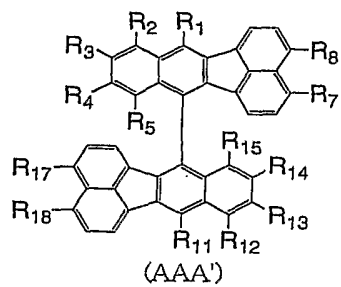

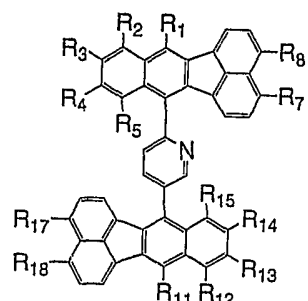

(LLL)

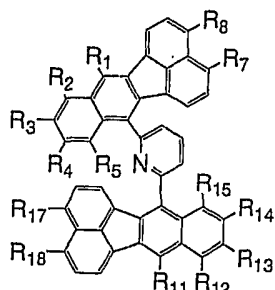

(MMM)

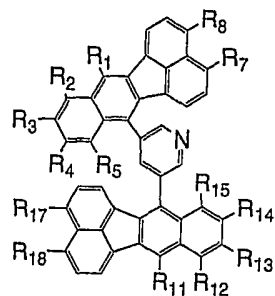

(NNN)

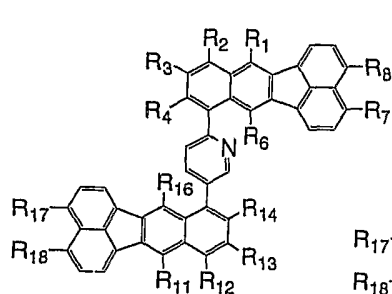

(OOO)

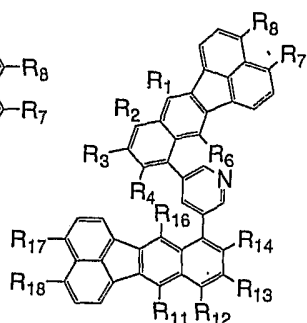

(PPP)

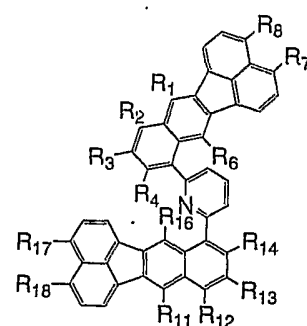

(QQQ)

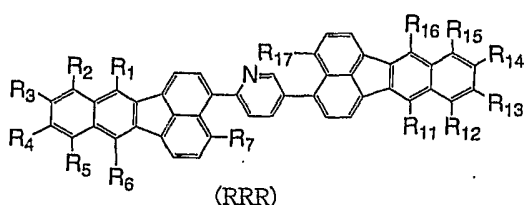

(RRR)

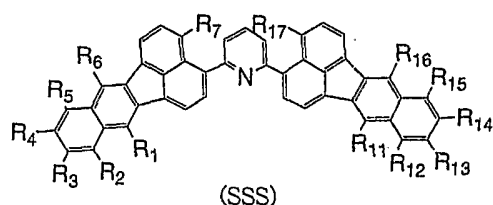

(SSS)

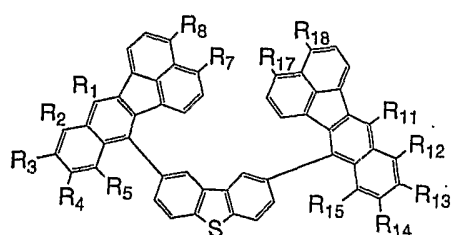

(TTT)

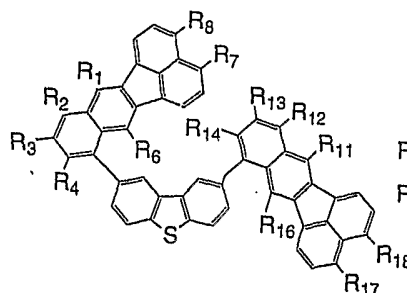

(UUU)

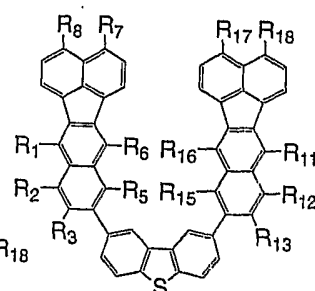

(VVV)

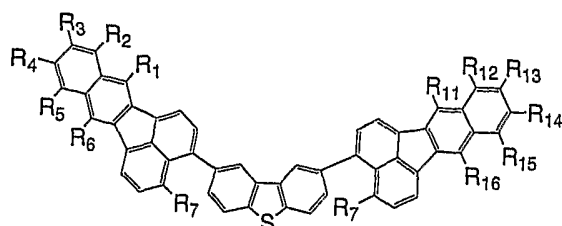

(WWW)

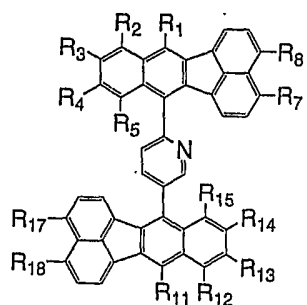

(LLL)

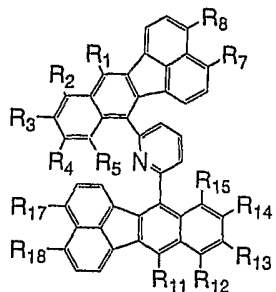

(MMM)

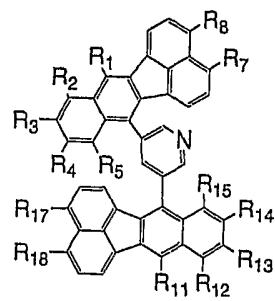

(NNN')

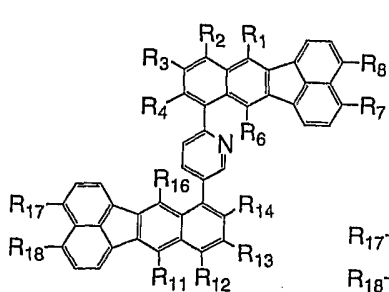

(OOO')

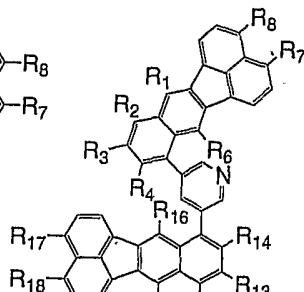

(PPP')

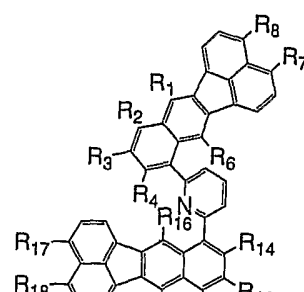

(QQQ')

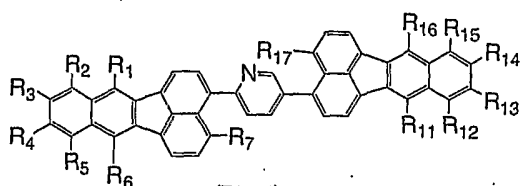

(RRR')

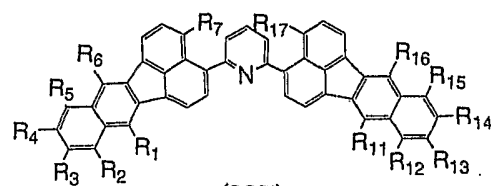

(SSS')

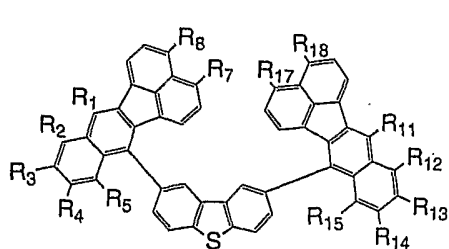

(TTT)

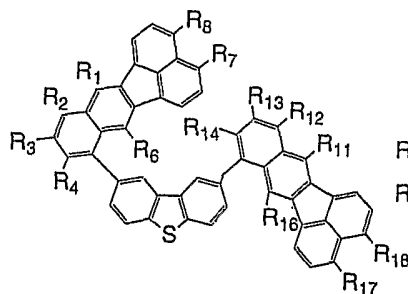

(UUU)

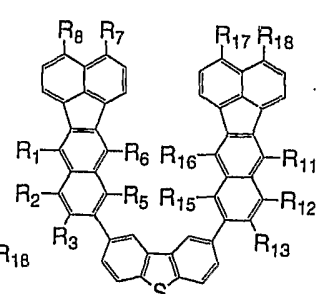

(VVV)

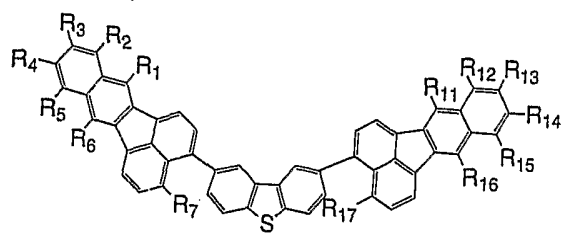

(WWW)

これらのなかでも、特に下記の式 (A), (B), (E), (H), (X), (Z)、および (AAA'), (BBB'), (CCC'), (DDD'), (EEE'), (RRR'), (SSS') で表される化合物が好ましい。

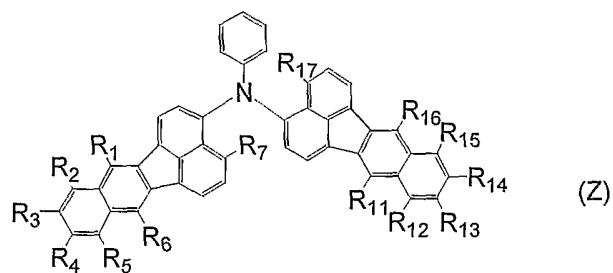
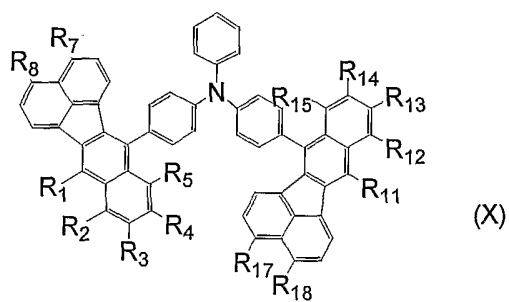
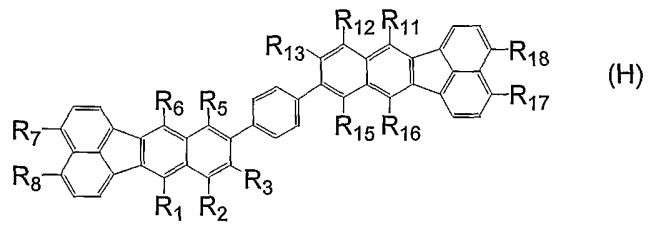
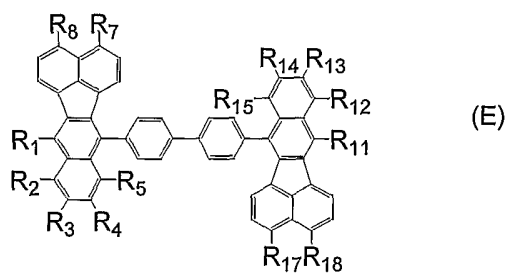
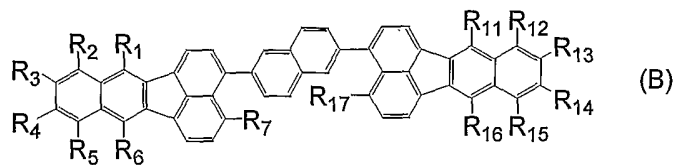
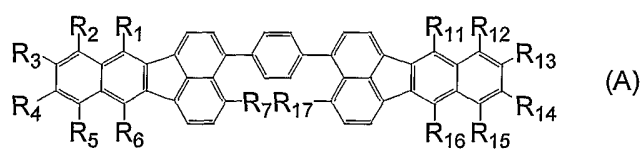

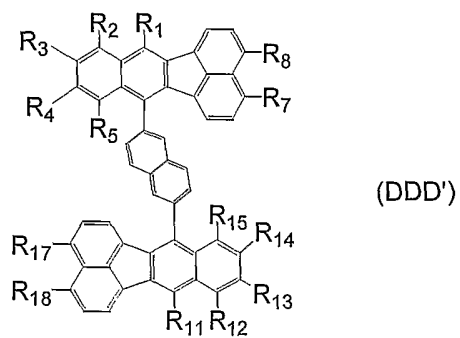
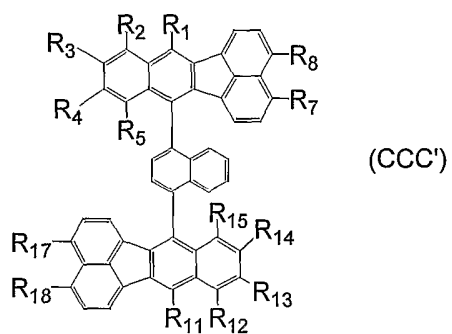
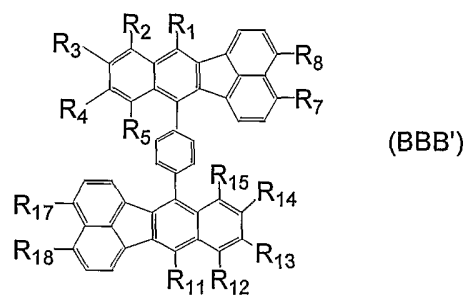
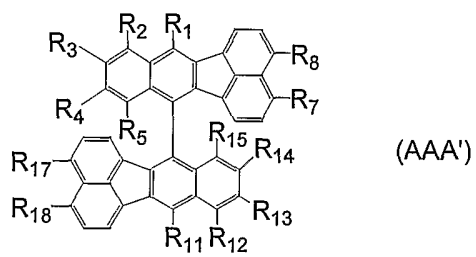

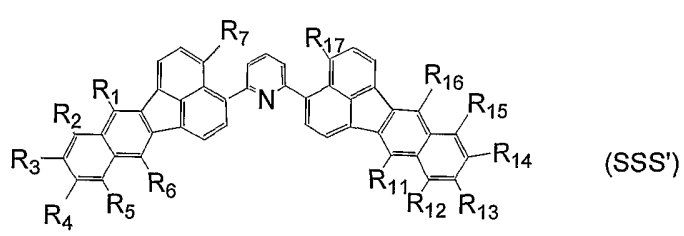
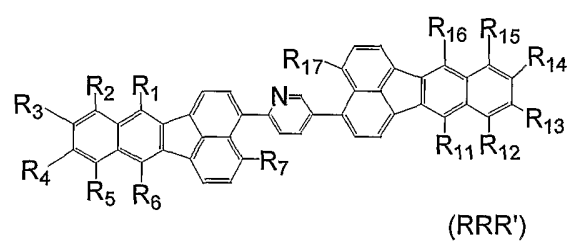
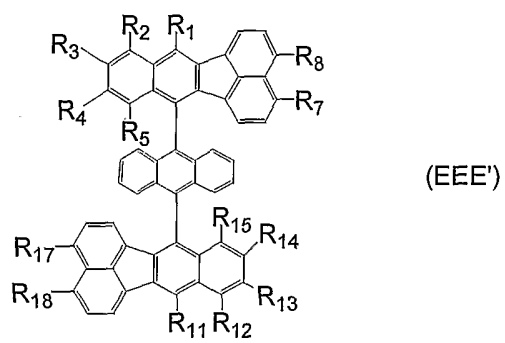



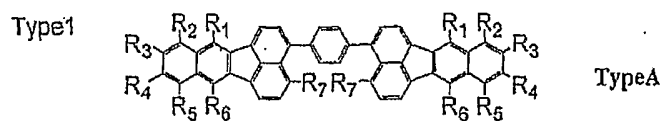



































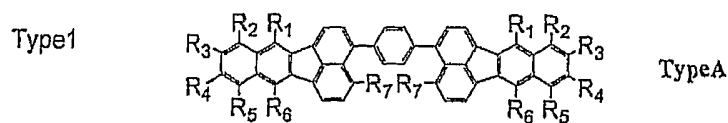

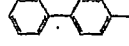
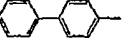
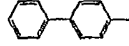
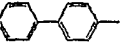
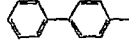
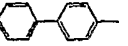
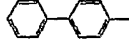
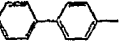
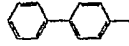
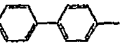
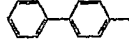
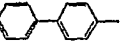
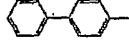
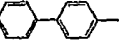
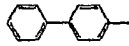
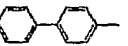
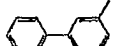
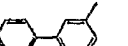
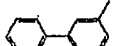
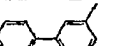
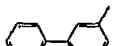
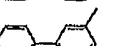

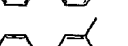
本発明の化合物のより具体的な例を以下に示す。

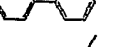
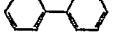
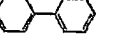
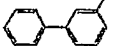
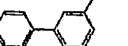
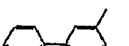
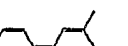

	R ₁	R ₂	R ₃	R ₄	R ₅	R ₆	R ₇
A-1	H	H	H	H	H	H	H
A-2	Ph	H	H	H	H	Ph	H
A-3	Ph	Ph	H	H	Ph	Ph	H
A-4	Ph	H	Ph	Ph	H	Ph	H
A-5	Ph	H	Ph	H	H	Ph	H
A-6	Ph	H	H	H	H	Ph	Ph
A-7	Ph	Me	H	H	Me	Ph	H
A-8	Ph	H	Me	Me	H	Ph	H
A-9	Ph	H	H	H	H	Ph	Me
A-10		H	H	H	H		H
A-11		Ph	H	H	Ph		H
A-12		H	Ph	Ph	H		H
A-13		H	Ph	H	H		H
A-14		H	H	H	H		Ph
A-15		Me	H	H	Me		H
A-16		H	Me	Me	H		H
A-17		H	H	H	H		Me
A-18		H	H	H	H		H
A-19		Ph	H	H	Ph		H
A-20		H	Ph	Ph	H		H
A-21		H	Ph	H	H		H
A-22		H	H	H	H		Ph
A-23		Me	H	H	Me		H
A-24		H	Me	Me	H		H
A-25		H	H	H	H		Me

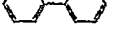
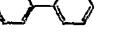
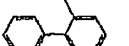
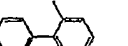
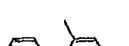

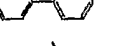
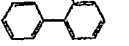
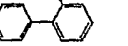
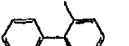
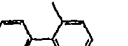

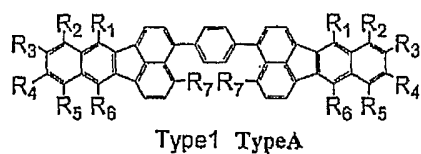



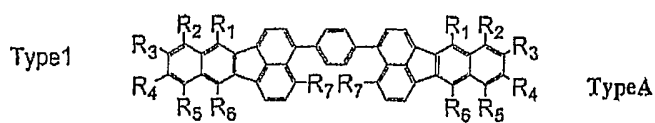

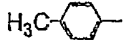
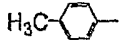
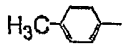
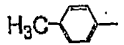
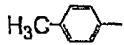
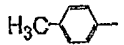
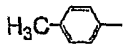
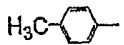
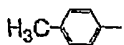
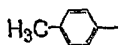
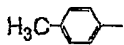
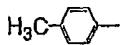
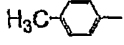
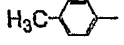
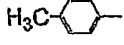
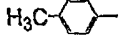
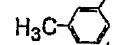
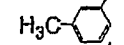
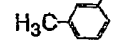
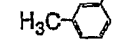
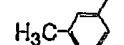
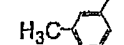
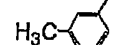
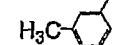
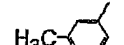
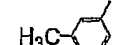
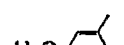

	R ₁	R ₂	R ₃	R ₄	R ₅	R ₆	R ₇
A-26		H	H	H	H		H
A-27		Ph	H	H	Ph		H
A-28		H	Ph	Ph	H		H
A-29		H	Ph	H	H		H
A-30		H	H	H	H		Ph
A-31		Me	H	H	Me		H
A-32		H	Me	Me	H		H
A-33		H	H	H	H		Me
A-34		H	H	H	H		H
A-35		Ph	H	H	Ph		H
A-36		H	Ph	Ph	H		H
A-37		H	Ph	H	H		H
A-38		H	H	H	H		Ph
A-39		Me	H	H	Me		H
A-40		H	Me	Me	H		H
A-41		H	H	H	H		Me
A-42		H	H	H	H		H
A-43		Ph	H	H	Ph		H
A-44		H	Ph	Ph	H		H
A-45		H	Ph	H	H		H
A-46		H	H	H	H		Ph
A-47		Me	H	H	Me		H
A-48		H	Me	Me	H		H
A-49		H	H	H	H		Me

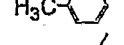
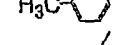
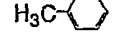
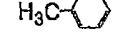
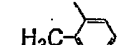
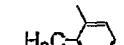

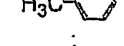
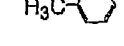
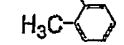
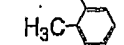
	R ₁	R ₂	R ₃	R ₄	R ₅	R ₆	R ₇
A-50	Ph	H	H	H	H		H
A-51	Ph	H	H	H	H		H
A-52	Ph	H	H	H	H		H
A-53	Ph	H	H	H	H		H
A-54	Ph	H	H	H	H		H
A-55		H	H	H	H		H
A-56		H	H	H	H		H
A-57		H	H	H	H		H
A-58		H	H	H	H		H
A-59		H	H	H	H		H
A-60		H	H	H	H		H
A-61		H	H	H	H		H
A-62		H	H	H	H		H
A-63		H	H	H	H		H
A-64		H	H	H	H		H
A-65	H	Ph	H	H	Ph	H	H
A-66	H		H	H		H	H
A-67	H		H	H		H	H
A-68	H		H	H		H	H
A-69	H		H	H		H	H
A-70	H		H	H		H	H
A-71	H	H			H	H	H
A-72	H	H			H	H	H
A-73	H	H			H	H	H
A-74	H	H			H	H	H
A-75	H	H			H	H	H

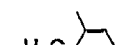

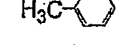
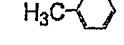
	R ₁	R ₂	R ₃	R ₄	R ₅	R ₆	R ₇
A-76		H	H	H	H		H
A-77		Ph	H	H	Ph		H
A-78		H	Ph	Ph	H		H
A-79		H	Ph	H	H		H
A-80		H	H	H	H		Ph
A-81		Me	H	H	Me		H
A-82		H	Me	Me	H		H
A-83		H	H	H	H		Me
A-84		H	H	H	H		H
A-85		Ph	H	H	Ph		H
A-86		H	Ph	Ph	H		H
A-87		H	Ph	H	H		H
A-88		H	H	H	H		Ph
A-89		Me	H	H	Me		H
A-90		H	Me	Me	H		H
A-91		H	H	H	H		Me
A-92		H	H	H	H		H
A-93		Ph	H	H	Ph		H
A-94		H	Ph	Ph	H		H
A-96		H	Ph	H	H		H
A-96		H	H	H	H		Ph
A-97		Me	H	H	Me		H
A-98		H	Me	Me	H		H
A-99		H	H	H	H		Me

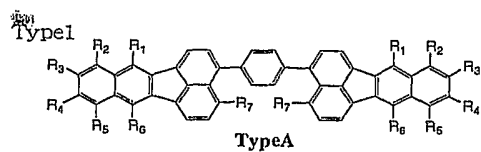

	R ₁	R ₂	R ₃	R ₄	R ₅	R ₆	R ₇
100		H	H	H	H		H
101		Ph	H	H	Ph		H
102		H	Ph	Ph	H		H
103		H	Ph	H	H		H
104		H	H	H	H		Ph
105		Me	H	H	Me		H
106		H	Me	Me	H		H
107		H	H	H	H		Me
108		H	H	H	H		H
109		Ph	H	H	Ph		H
110		H	Ph	Ph	H		H
111		H	Ph	H	H		H
112		H	H	H	H		Ph
113		Me	H	H	Me		H
114		H	Me	Me	H		H
115		H	H	H	H		Me
116		H	H	H	H		H
117		Ph	H	H	Ph		H
118		H	Ph	Ph	H		H
119		H	Ph	H	H		H
120		H	H	H	H		Ph
121		Me	H	H	Me		H
122		H	Me	Me	H		H
123		H	H	H	H		Me

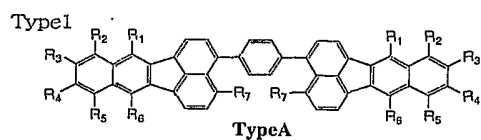

	R ₁	R ₂	R ₃	R ₄	R ₅	R ₆	R ₇
124		H	H	H	H		H
125		Ph	H	H	Ph		H
126		H	Ph	Ph	H		H
127		H	Ph	H	H		H
128		H	H	H	H		Ph
129		Me	H	H	Me		H
130		H	Me	Me	H		H
131		H	H	H	H		Me
132		H	H	H	H		H
133		Ph	H	H	Ph		H
134		H	Ph	Ph	H		H
135		H	Ph	H	H		H
136		H	H	H	H		Ph
137		Me	H	H	Me		H
138		H	Me	Me	H		H
139		H	H	H	H		Me
140		H	H	H	H		H
141		Ph	H	H	Ph		H
142		H	Ph	Ph	H		H
143		H	Ph	H	H		H
144		H	H	H	H		Ph
145		Me	H	H	Me		H
146		H	Me	Me	H		H
147		H	H	H	H		Me

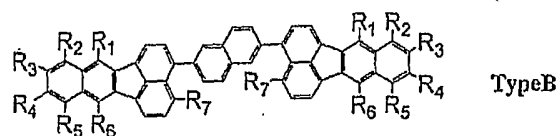



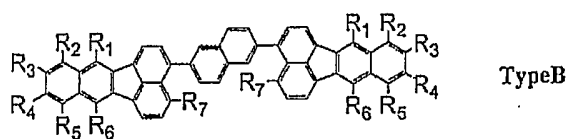



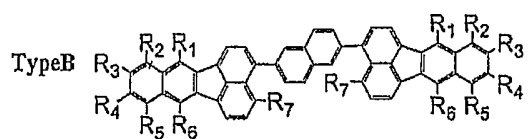



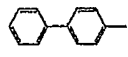
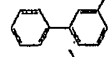
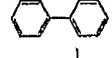



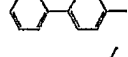

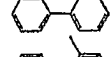

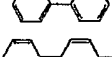



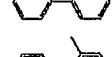

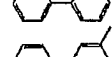

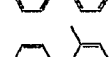

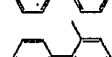
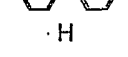
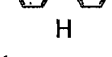



	R ₁	R ₂	R ₃	R ₄	R ₅	R ₆	R ₇
B-1	H	H	H	H	H	H	H
B-2	Ph	H	H	H	H	Ph	H
B-3	Ph	Ph	H	H	Ph	Ph	H
B-4	Ph	H	Ph	Ph	H	Ph	H
B-5	Ph	H	Ph	H	H	Ph	H
B-6	Ph	H	H	H	H	Ph	Ph
B-7	Ph	Me	H	H	Me	Ph	H
B-8	Ph	H	Me	Me	H	Ph	H
B-9	Ph	H	H	H	H	Ph	Me
B-10		H	H	H	H		H
B-11		Ph	H	H	Ph		H
B-12		H	Ph	Ph	H		H
B-13		H	Ph	H	H		H
B-14		H	H	H	H		Ph
B-15		Me	H	H	Me		H
B-16		H	Me	Me	H		H
B-17		H	H	H	H		Me
B-18		H	H	H	H		H
B-19		Ph	H	H	Ph		H
B-20		H	Ph	Ph	H		H
B-21		H	Ph	H	H		H
B-22		H	H	H	H		Ph
B-23		Me	H	H	Me		H
B-24		H	Me	Me	H		H
B-25		H	H	H	H		Me

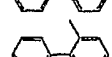
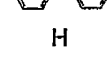
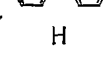

	R ₁	R ₂	R ₃	R ₄	R ₅	R ₆	R ₇
B-26		H	H	H	H		H
B-27		Ph	H	H	Ph		H
B-28		H	Ph	Ph	H		H
B-29		H	Ph	H	H		H
B-30		H	H	H	H		Ph
B-31		Me	H	H	Me		H
B-32		H	Me	Me	H		H
B-33		H	H	H	H		Me
B-34		H	H	H	H		H
B-35		Ph	H	H	Ph		H
B-36		H	Ph	Ph	H		H
B-37		H	Ph	H	H		H
B-38		H	H	H	H		Ph
B-39		Me	H	H	Me		H
B-40		H	Me	Me	H		H
B-41		H	H	H	H		Me
B-42		H	H	H	H		H
B-43		Ph	H	H	Ph		H
B-44		H	Ph	Ph	H		H
B-45		H	Ph	H	H		H
B-46		H	H	H	H		Ph
B-47		Me	H	H	Me		H
B-48		H	Me	Me	H		H
B-49		H	H	H	H		Me

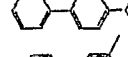
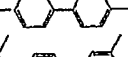
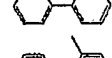
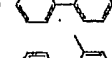
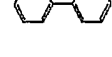
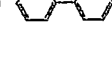

	R ₁	R ₂	R ₃	R ₄	R ₅	R ₆	R ₇
B-50	Ph	H	H	H	H		H
B-51	Ph	H	H	H	H		H
B-52	Ph	H	H	H	H		H
B-53	Ph	H	H	H	H		H
B-54	Ph	H	H	H	H		H
B-55		H	H	H	H		H
B-56		H	H	H	H		H
B-57		H	H	H	H		H
B-58		H	H	H	H		H
B-59		H	H	H	H		H
B-60		H	H	H	H		H
B-61		H	H	H	H		H
B-62		H	H	H	H		H
B-63		H	H	H	H		H
B-64		H	H	H	H		H
B-65	H	Ph	H	H	Ph	H	H
B-66	H		H	H		H	H
B-67	H		H	H		H	H
B-68	H		H	H		H	H
B-69	H		H	H		H	H
B-70	H		H	H		H	H
B-71	H	H			H	H	H
B-72	H	H			H	H	H
B-73	H	H			H	H	H
B-74	H	H			H	H	H
B-75	H	H			H	H	H

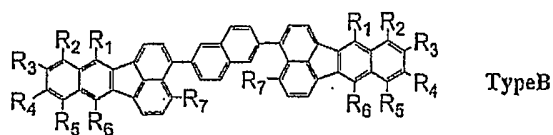

	R ₁	R ₂	R ₃	R ₄	R ₅	R ₆	R ₇
B-76		H	H	H	H		H
B-77		Ph	H	H	Ph		H
B-78		H	Ph	Ph	H		H
B-79		H	Ph	H	H		H
B-80		H	H	H	H		Ph
B-81		Me	H	H	Me		H
B-82		H	Me	Me	H		H
B-83		H	H	H	H		Me
B-84		H	H	H	H		H
B-85		Ph	H	H	Ph		H
B-86		H	Ph	Ph	H		H
B-87		H	Ph	H	H		H
B-88		H	H	H	H		Ph
B-89		Me	H	H	Me		H
B-90		H	Me	Me	H		H
B-91		H	H	H	H		Me
B-92		H	H	H	H		H
B-93		Ph	H	H	Ph		H
B-94		H	Ph	Ph	H		H
B-96		H	Ph	H	H		H
B-96		H	H	H	H		Ph
B-97		Me	H	H	Me		H
B-98		H	Me	Me	H		H
B-99		H	H	H	H		Me

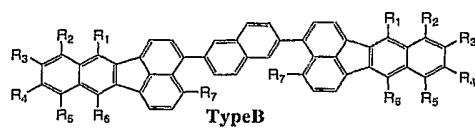

	R ₁	R ₂	R ₃	R ₄	R ₅	R ₆	R ₇
100		H	H	H	H		H
101		Ph	H	H	Ph		H
102		H	Ph	Ph	H		H
103		H	Ph	H	H		H
104		H	H	H	H		Ph
105		Me	H	H	Me		H
106		H	Me	Me	H		H
107		H	H	H	H		Me
108		H	H	H	H		H
109		Ph	H	H	Ph		H
110		H	Ph	Ph	H		H
111		H	Ph	H	H		H
112		H	H	H	H		Ph
113		Me	H	H	Me		H
114		H	Me	Me	H		H
115		H	H	H	H		Me
116		H	H	H	H		H
117		Ph	H	H	Ph		H
118		H	Ph	Ph	H		H
119		H	Ph	H	H		H
120		H	H	H	H		Ph
121		Me	H	H	Me		H
122		H	Me	Me	H		H
123		H	H	H	H		Me

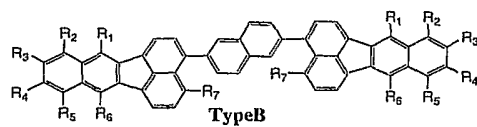

	R ₁	R ₂	R ₃	R ₄	R ₅	R ₆	R ₇
124		H	H	H	H		H
125		Ph	H	H	Ph		H
126		H	Ph	Ph	H		H
127		H	Ph	H	H		H
128		H	H	H	H		Ph
129		Me	H	H	Me		H
130		H	Me	Me	H		H
131		H	H	H	H		Me
132		H	H	H	H		H
133		Ph	H	H	Ph		H
134		H	Ph	Ph	H		H
135		H	Ph	H	H		H
136		H	H	H	H		Ph
137		Me	H	H	Me		H
138		H	Me	Me	H		H
139		H	H	H	H		Me
140		H	H	H	H		H
141		Ph	H	H	Ph		H
142		H	Ph	Ph	H		H
143		H	Ph	H	H		H
144		H	H	H	H		Ph
145		Me	H	H	Me		H
146		H	Me	Me	H		H
147		H	H	H	H		Me

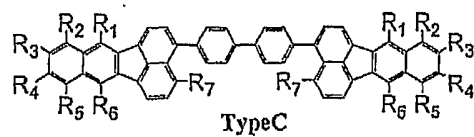

	R ₁	R ₂	R ₃	R ₄	R ₅	R ₆	R ₇
C-1	H	H	H	H	H	H	H
C-2	Ph	H	H	H	H	Ph	H
C-3	Ph	Ph	H	H	Ph	Ph	H
C-4	Ph	H	Ph	Ph	H	Ph	H
C-5	Ph	H	Ph	H	H	Ph	H
C-6	Ph	H	H	H	H	Ph	Ph
C-7	Ph	Me	H	H	Me	Ph	H
C-8	Ph	H	Me	Me	H	Ph	H
C-9	Ph	H	H	H	H	Ph	Me
C-10		H	H	H	H		H
C-11		Ph	H	H	Ph		H
C-12		H	Ph	Ph	H		H
C-13		H	Ph	H	H		H
C-14		H	H	H	H		Ph
C-15		Me	H	H	Me		H
C-16		H	Me	Me	H		H
C-17		H	H	H	H		Me
C-18		H	H	H	H		H
C-19		Ph	H	H	Ph		H
C-20		H	Ph	Ph	H		H
C-21		H	Ph	H	H		H
C-22		H	H	H	H		Ph
C-23		Me	H	H	Me		H
C-24		H	Me	Me	H		H
C-25		H	H	H	H		Me

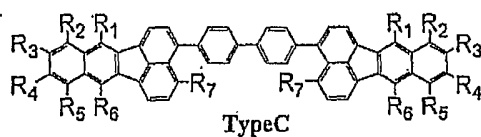

	R ₁	R ₂	R ₃	R ₄	R ₅	R ₆	R ₇
C-26		H	H	H	H		H
C-27		Ph	H	H	Ph		H
C-28		H	Ph	Ph	H		H
C-29		H	Ph	H	H		H
C-30		H	H	H	H		Ph
C-31		Me	H	H	Me		H
C-32		H	Me	Me	H		H
C-33		H	H	H	H		Me
C-34		H	H	H	H		H
C-35		Ph	H	H	Ph		H
C-36		H	Ph	Ph	H		H
C-37		H	Ph	H	H		H
C-38		H	H	H	H		Ph
C-39		Me	H	H	Me		H
C-40		H	Me	Me	H		H
C-41		H	H	H	H		Me
C-42		H	H	H	H		H
C-43		Ph	H	H	Ph		H
C-44		H	Ph	Ph	H		H
C-45		H	Ph	H	H		H
C-46		H	H	H	H		Ph
C-47		Me	H	H	Me		H
C-48		H	Me	Me	H		H
C-49		H	H	H	H		Me

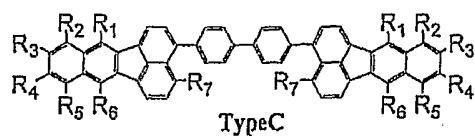

	R ₁	R ₂	R ₃	R ₄	R ₅	R ₆	R ₇
C-50	Ph	H	H	H	H		H
C-51	Ph	H	H	H	H		H
C-52	Ph	H	H	H	H		H
C-53	Ph	H	H	H	H		H
C-54	Ph	H	H	H	H		H
C-55		H	H	H	H		H
C-56		H	H	H	H		H
C-57		H	H	H	H		H
C-58		H	H	H	H		H
C-59		H	H	H	H		H
C-60		H	H	H	H		H
C-61		H	H	H	H		H
C-62		H	H	H	H		H
C-63		H	H	H	H		H
C-64		H	H	H	H		H
C-65	H	Ph	H	H	Ph	H	H
C-66	H		H	H		H	H
C-67	H		H	H		H	H
C-68	H		H	H		H	H
C-69	H		H	H		H	H
C-70	H		H	H		H	H
C-71	H	H			H	H	H
C-72	H	H			H	H	H
C-73	H	H			H	H	H
C-74	H	H			H	H	H
C-75	H	H			H	H	H

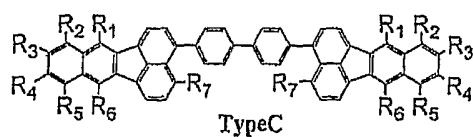

	R ₁	R ₂	R ₃	R ₄	R ₅	R ₆	R ₇
C-76		H	H	H	H		H
C-77		Ph	H	H	Ph		H
C-78		H	Ph	Ph	H		H
C-79		H	Ph	H	H		H
C-80		H	H	H	H		Ph
C-81		Me	H	H	Me		H
C-82		H	Me	Me	H		H
C-83		H	H	H	H		Me
C-84		H	H	H	H		H
C-85		Ph	H	H	Ph		H
C-86		H	Ph	Ph	H		H
C-87		H	Ph	H	H		H
C-88		H	H	H	H		Ph
C-89		Me	H	H	Me		H
C-90		H	Me	Me	H		H
C-91		H	H	H	H		Me
C-92		H	H	H	H		H
C-93		Ph	H	H	Ph		H
C-94		H	Ph	Ph	H		H
C-96		H	Ph	H	H		H
C-96		H	H	H	H		Ph
C-97		Me	H	H	Me		H
C-98		H	Me	Me	H		H
C-99		H	H	H	H		Me

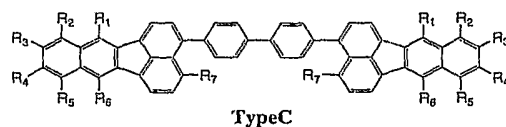

	R ₁	R ₂	R ₃	R ₄	R ₅	R ₆	R ₇
100		H	H	H	H		H
101		Ph	H	H	Ph		H
102		H	Ph	Ph	H		H
103		H	Ph	H	H		H
104		H	H	H	H		Ph
105		Me	H	H	Me		H
106		H	Me	Me	H		H
107		H	H	H	H		Me
108		H	H	H	H		H
109		Ph	H	H	Ph		H
110		H	Ph	Ph	H		H
111		H	Ph	H	H		H
112		H	H	H	H		Ph
113		Me	H	H	Me		H
114		H	Me	Me	H		H
115		H	H	H	H		Me
116		H	H	H	H		H
117		Ph	H	H	Ph		H
118		H	Ph	Ph	H		H
119		H	Ph	H	H		H
120		H	H	H	H		Ph
121		Me	H	H	Me		H
122		H	Me	Me	H		H
123		H	H	H	H		Me

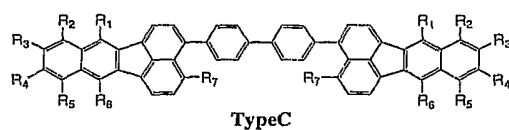

	R ₁	R ₂	R ₃	R ₄	R ₅	R ₆	R ₇
124		H	H	H	H		H
125		Ph	H	H	Ph		H
126		H	Ph	Ph	H		H
127		H	Ph	H	H		H
128		H	H	H	H		Ph
129		Me	H	H	Me		H
130		H	Me	Me	H		H
131		H	H	H	H		Me
132		H	H	H	H		H
133		Ph	H	H	Ph		H
134		H	Ph	Ph	H		H
135		H	Ph	H	H		H
136		H	H	H	H		Ph
137		Me	H	H	Me		H
138		H	Me	Me	H		H
139		H	H	H	H		Me
140		H	H	H	H		H
141		Ph	H	H	Ph		H
142		H	Ph	Ph	H		H
143		H	Ph	H	H		H
144		H	H	H	H		Ph
145		Me	H	H	Me		H
146		H	Me	Me	H		H
147		H	H	H	H		Me

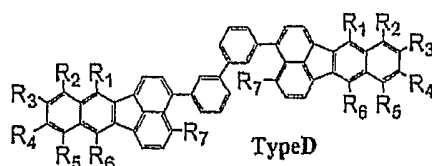

	R ₁	R ₂	R ₃	R ₄	R ₅	R ₆	R ₇
D-1	H	H	H	H	H	H	H
D-2	Ph	H	H	H	H	Ph	H
D-3	Ph	Ph	H	H	Ph	Ph	H
D-4	Ph	H	Ph	Ph	H	Ph	H
D-5	Ph	H	Ph	H	H	Ph	H
D-6	Ph	H	H	H	H	Ph	Ph
D-7	Ph	Me	H	H	Me	Ph	H
D-8	Ph	H	Me	Me	H	Ph	H
D-9	Ph	H	H	H	H	Ph	Me
D-10		H	H	H	H		H
D-11		Ph	H	H	Ph		H
D-12		H	Ph	Ph	H		H
D-13		H	Ph	H	H		H
D-14		H	H	H	H		Ph
D-15		Me	H	H	Me		H
D-16		H	Me	Me	H		H
D-17		H	H	H	H		Me
D-18		H	H	H	H		H
D-19		Ph	H	H	Ph		H
D-20		H	Ph	Ph	H		H
D-21		H	Ph	H	H		H
D-22		H	H	H	H		Ph
D-23		Me	H	H	Me		H
D-24		H	Me	Me	H		H
D-25		H	H	H	H		Me

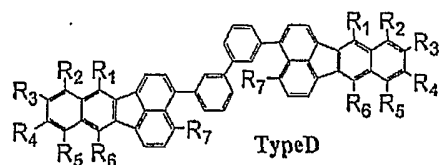

	R ₁	R ₂	R ₃	R ₄	R ₅	R ₆	R ₇
D-26		H	H	H	H		H
D-27		Ph	H	H	Ph		H
D-28		H	Ph	Ph	H		H
D-29		H	Ph	H	H		H
D-30		H	H	H	H		Ph
D-31		Me	H	H	Me		H
D-32		H	Me	Me	H		H
D-33		H	H	H	H		Me
D-34		H	H	H	H		H
D-35		Ph	H	H	Ph		H
D-36		H	Ph	Ph	H		H
D-37		H	Ph	H	H		H
D-38		H	H	H	H		Ph
D-39		Me	H	H	Me		H
D-40		H	Me	Me	H		H
D-41		H	H	H	H		Me
D-42		H	H	H	H		H
D-43		Ph	H	H	Ph		H
D-44		H	Ph	Ph	H		H
D-45		H	Ph	H	H		H
D-46		H	H	H	H		Ph
D-47		Me	H	H	Me		H
D-48		H	Me	Me	H		H
D-49		H	H	H	H		Me

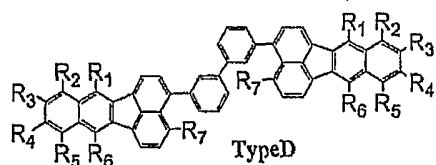

	R ₁	R ₂	R ₃	R ₄	R ₅	R ₆	R ₇
D-50	Ph	H	H	H	H		H
D-51	Ph	H	H	H	H		H
D-52	Ph	H	H	H	H		H
D-53	Ph	H	H	H	H		H
D-54	Ph	H	H	H	H		H
D-55		H	H	H	H		H
D-56		H	H	H	H		H
D-57		H	H	H	H		H
D-58		H	H	H	H		H
D-59		H	H	H	H		H
D-60		H	H	H	H		H
D-61		H	H	H	H		H
D-62		H	H	H	H		H
D-63		H	H	H	H		H
D-64		H	H	H	H		H
D-65	H	Ph	H	H	Ph	H	H
D-66	H		H	H		H	H
D-67	H		H	H		H	H
D-68	H		H	H		H	H
D-69	H		H	H		H	H
D-70	H		H	H		H	H
D-71	H	H			H	H	H
D-72	H	H			H	H	H
D-73	H	H			H	H	H
D-74	H	H			H	H	H
D-75	H	H			H	H	H

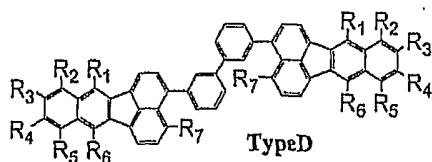

	R ₁	R ₂	R ₃	R ₄	R ₅	R ₆	R ₇
D-76		H	H	H	H		H
D-77		Ph	H	H	Ph		H
D-78		H	Ph	Ph	H		H
D-79		H	Ph	H	H		H
D-80		H	H	H	H		Ph
D-81		Me	H	H	Me		H
D-82		H	Me	Me	H		H
D-83		H	H	H	H		Me
D-84		H	H	H	H		H
D-85		Ph	H	H	Ph		H
D-86		H	Ph	Ph	H		H
D-87		H	Ph	H	H		H
D-88		H	H	H	H		Ph
D-89		Me	H	H	Me		H
D-90		H	Me	Me	H		H
D-91		H	H	H	H		Me
D-92		H	H	H	H		H
D-93		Ph	H	H	Ph		H
D-94		H	Ph	Ph	H		H
D-96		H	Ph	H	H		H
D-96		H	H	H	H		Ph
D-97		Me	H	H	Me		H
D-98		H	Me	Me	H		H
D-99		H	H	H	H		Me

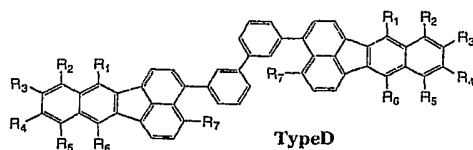

	R ₁	R ₂	R ₃	R ₄	R ₅	R ₆	R ₇
100		H	H	H	H		H
101		Ph	H	H	Ph		H
102		H	Ph	Ph	H		H
103		H	Ph	H	H		H
104		H	H	H	H		Ph
105		Me	H	H	Me		H
106		H	Me	Me	H		H
107		H	H	H	H		Me
108		H	H	H	H		H
109		Ph	H	H	Ph		H
110		H	Ph	Ph	H		H
111		H	Ph	H	H		H
112		H	H	H	H		Ph
113		Me	H	H	Me		H
114		H	Me	Me	H		H
115		H	H	H	H		Me
116		H	H	H	H		H
117		Ph	H	H	Ph		H
118		H	Ph	Ph	H		H
119		H	Ph	H	H		H
120		H	H	H	H		Ph
121		Me	H	H	Me		H
122		H	Me	Me	H		H
123		H	H	H	H		Me

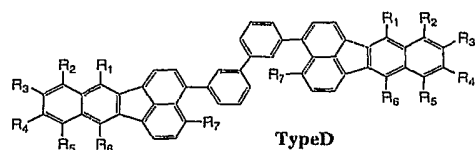

	R ₁	R ₂	R ₃	R ₄	R ₅	R ₆	R ₇
124		H	H	H	H		H
125		Ph	H	H	Ph		H
126		H	Ph	Ph	H		H
127		H	Ph	H	H		H
128		H	H	H	H		Ph
129		Me	H	H	Me		H
130		H	Me	Me	H		H
131		H	H	H	H		Me
132		H	H	H	H		H
133		Ph	H	H	Ph		H
134		H	Ph	Ph	H		H
135		H	Ph	H	H		H
136		H	H	H	H		Ph
137		Me	H	H	Me		H
138		H	Me	Me	H		H
139		H	H	H	H		Me
140		H	H	H	H		H
141		Ph	H	H	Ph		H
142		H	Ph	Ph	H		H
143		H	Ph	H	H		H
144		H	H	H	H		Ph
145		Me	H	H	Me		H
146		H	Me	Me	H		H
147		H	H	H	H		Me

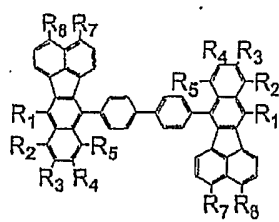

Type E

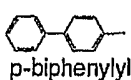
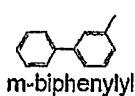
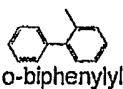
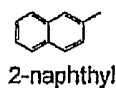
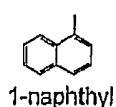

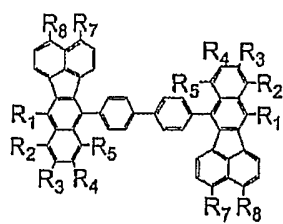

	R ₁	R ₂	R ₃	R ₄	R ₅	R ₇	R ₈
E-1	H	H	H	H	H	H	H
E-2	Ph	H	H	H	H	H	H
E-3	Ph	Ph	H	H	Ph	H	H
E-4	Ph	H	Ph	Ph	H	H	H
E-5	Ph	H	Ph	H	H	H	H
E-6	Ph	H	H	Ph	H	H	H
E-7	Ph	H	H	H	H	Ph	H
E-8	Ph	H	H	H	H	H	Ph
E-9	Ph	H	H	H	H	Ph	Ph
E-10	Ph	H	H	H	H	1-naphthyl	H
E-11	Ph	H	H	H	H	H	1-naphthyl
E-12	Ph	H	H	H	H	1-naphthyl	1-naphthyl
E-13	Ph	H	H	H	H	2-naphthyl	H
E-14	Ph	H	H	H	H	H	2-naphthyl
E-15	Ph	H	H	H	H	2-naphthyl	2-naphthyl
E-16	Ph	H	H	H	H	o-biphenyl	H
E-17	Ph	H	H	H	H	H	o-biphenyl
E-18	Ph	H	H	H	H	o-biphenyl	o-biphenyl
E-19	Ph	H	H	H	H	m-biphenyl	H
E-20	Ph	H	H	H	H	H	m-biphenyl
E-21	Ph	H	H	H	H	m-biphenyl	m-biphenyl
E-22	Ph	H	H	H	H	p-biphenyl	H
E-23	Ph	H	H	H	H	H	p-biphenyl
E-24	Ph	H	H	H	H	p-biphenyl	p-biphenyl
E-25	1-naphthyl	H	H	H	H	H	H
E-26	1-naphthyl	Ph	H	H	Ph	H	H
E-27	1-naphthyl	H	Ph	Ph	H	H	H
E-28	1-naphthyl	H	Ph	H	H	H	H
E-29	1-naphthyl	H	H	Ph	H	H	H
E-30	1-naphthyl	H	H	H	H	Ph	H
E-31	1-naphthyl	H	H	H	H	H	Ph
E-32	1-naphthyl	H	H	H	H	Ph	Ph
E-33	1-naphthyl	H	H	H	H	1-naphthyl	H
E-34	1-naphthyl	H	H	H	H	H	1-naphthyl
E-35	1-naphthyl	H	H	H	H	1-naphthyl	1-naphthyl
E-36	1-naphthyl	H	H	H	H	2-naphthyl	H
E-37	1-naphthyl	H	H	H	H	H	2-naphthyl
E-38	1-naphthyl	H	H	H	H	2-naphthyl	2-naphthyl
E-39	1-naphthyl	H	H	H	H	o-biphenyl	H
E-40	1-naphthyl	H	H	H	H	H	o-biphenyl
E-41	1-naphthyl	H	H	H	H	o-biphenyl	o-biphenyl
E-42	1-naphthyl	H	H	H	H	m-biphenyl	H
E-43	1-naphthyl	H	H	H	H	H	m-biphenyl
E-44	1-naphthyl	H	H	H	H	m-biphenyl	m-biphenyl
E-45	1-naphthyl	H	H	H	H	p-biphenyl	H
E-46	1-naphthyl	H	H	H	H	H	p-biphenyl
E-47	1-naphthyl	H	H	H	H	p-biphenyl	p-biphenyl

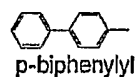
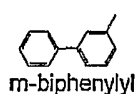
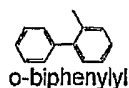
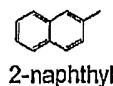
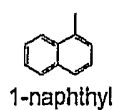

Type E

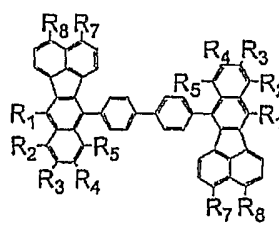

	R ₁	R ₂	R ₃	R ₄	R ₅	R ₇	R ₈
E-48	2-naphthyl	H	H	H	H	H	H
E-49	2-naphthyl	Ph	H	H	Ph	H	H
E-50	2-naphthyl	H	Ph	Ph	H	H	H
E-51	2-naphthyl	H	Ph	H	H	H	H
E-52	2-naphthyl	H	H	Ph	H	H	H
E-53	2-naphthyl	H	H	H	H	Ph	H
E-54	2-naphthyl	H	H	H	H	H	Ph
E-55	2-naphthyl	H	H	H	H	Ph	Ph
E-56	2-naphthyl	H	H	H	H	1-naphthyl	H
E-57	2-naphthyl	H	H	H	H	H	1-naphthyl
E-58	2-naphthyl	H	H	H	H	1-naphthyl	1-naphthyl
E-59	2-naphthyl	H	H	H	H	2-naphthyl	H
E-60	2-naphthyl	H	H	H	H	H	2-naphthyl
E-61	2-naphthyl	H	H	H	H	2-naphthyl	2-naphthyl
E-62	2-naphthyl	H	H	H	H	o-biphenyl	H
E-63	2-naphthyl	H	H	H	H	H	o-biphenyl
E-64	2-naphthyl	H	H	H	H	o-biphenyl	o-biphenyl
E-65	2-naphthyl	H	H	H	H	m-biphenyl	H
E-66	2-naphthyl	H	H	H	H	H	m-biphenyl
E-67	2-naphthyl	H	H	H	H	m-biphenyl	m-biphenyl
E-68	2-naphthyl	H	H	H	H	p-biphenyl	H
E-69	2-naphthyl	H	H	H	H	H	p-biphenyl
E-70	2-naphthyl	H	H	H	H	p-biphenyl	p-biphenyl
E-71	o-biphenyl	H	H	H	H	H	H
E-72	o-biphenyl	Ph	H	H	Ph	H	H
E-73	o-biphenyl	H	Ph	Ph	H	H	H
E-74	o-biphenyl	H	Ph	H	H	H	H
E-75	o-biphenyl	H	H	Ph	H	H	H
E-76	o-biphenyl	H	H	H	H	Ph	H
E-77	o-biphenyl	H	H	H	H	H	Ph
E-78	o-biphenyl	H	H	H	H	Ph	Ph
E-79	o-biphenyl	H	H	H	H	1-naphthyl	H
E-80	o-biphenyl	H	H	H	H	H	1-naphthyl
E-81	o-biphenyl	H	H	H	H	1-naphthyl	1-naphthyl
E-82	o-biphenyl	H	H	H	H	2-naphthyl	H
E-83	o-biphenyl	H	H	H	H	H	2-naphthyl
E-84	o-biphenyl	H	H	H	H	2-naphthyl	2-naphthyl
E-85	o-biphenyl	H	H	H	H	o-biphenyl	H
E-86	o-biphenyl	H	H	H	H	H	o-biphenyl
E-87	o-biphenyl	H	H	H	H	o-biphenyl	o-biphenyl
E-88	o-biphenyl	H	H	H	H	m-biphenyl	H
E-89	o-biphenyl	H	H	H	H	H	m-biphenyl
E-90	o-biphenyl	H	H	H	H	m-biphenyl	m-biphenyl
E-91	o-biphenyl	H	H	H	H	p-biphenyl	H
E-92	o-biphenyl	H	H	H	H	H	p-biphenyl
E-93	o-biphenyl	H	H	H	H	p-biphenyl	p-biphenyl

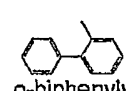
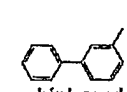
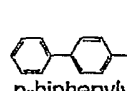
	R ₁	R ₂	R ₃	R ₄	R ₅	R ₇	R ₈	
 <p>Type E</p>	E-94	m-biphenyl	H	H	H	H	H	
	E-95	m-biphenyl	Ph	H	H	Ph	H	
	E-96	m-biphenyl	H	Ph	Ph	H	H	
	E-97	m-biphenyl	H	Ph	H	H	H	
	E-98	m-biphenyl	H	H	Ph	H	H	
	E-99	m-biphenyl	H	H	H	H	Ph	
	E-100	m-biphenyl	H	H	H	H	H	Ph
	E-101	m-biphenyl	H	H	H	H	Ph	Ph
	E-102	m-biphenyl	H	H	H	H	1-naphthyl	H
	E-103	m-biphenyl	H	H	H	H	H	1-naphthyl
 <p>1-naphthyl</p>	E-104	m-biphenyl	H	H	H	H	1-naphthyl	
	E-105	m-biphenyl	H	H	H	H	2-naphthyl	H
 <p>2-naphthyl</p>	E-106	m-biphenyl	H	H	H	H	2-naphthyl	
	E-107	m-biphenyl	H	H	H	H	2-naphthyl	2-naphthyl
 <p>o-biphenyl</p>								
	E-108	m-biphenyl	H	H	H	H	o-biphenyl	H
 <p>m-biphenyl</p>								
	E-109	m-biphenyl	H	H	H	H	H	o-biphenyl
 <p>p-biphenyl</p>								
	E-110	m-biphenyl	H	H	H	H	o-biphenyl	o-biphenyl
E-111	m-biphenyl	H	H	H	H	m-biphenyl	H	
E-112	m-biphenyl	H	H	H	H	H	m-biphenyl	
E-113	m-biphenyl	H	H	H	H	m-biphenyl	m-biphenyl	
E-114	m-biphenyl	H	H	H	H	p-biphenyl	H	
E-115	m-biphenyl	H	H	H	H	H	p-biphenyl	
E-116	m-biphenyl	H	H	H	H	p-biphenyl	p-biphenyl	
E-117	p-biphenyl	H	H	H	H	H	H	
E-118	p-biphenyl	Ph	H	H	Ph	H	H	
E-119	p-biphenyl	H	Ph	Ph	H	H	H	
E-120	p-biphenyl	H	Ph	H	H	H	H	
E-121	p-biphenyl	H	H	Ph	H	H	H	
E-122	p-biphenyl	H	H	H	H	Ph	H	
E-123	p-biphenyl	H	H	H	H	H	Ph	
E-124	p-biphenyl	H	H	H	H	Ph	Ph	
E-125	p-biphenyl	H	H	H	H	1-naphthyl	H	
E-126	p-biphenyl	H	H	H	H	H	1-naphthyl	
E-127	p-biphenyl	H	H	H	H	1-naphthyl	1-naphthyl	
E-128	p-biphenyl	H	H	H	H	2-naphthyl	H	
E-129	p-biphenyl	H	H	H	H	H	2-naphthyl	
E-130	p-biphenyl	H	H	H	H	2-naphthyl	2-naphthyl	
E-131	p-biphenyl	H	H	H	H	o-biphenyl	H	
E-132	p-biphenyl	H	H	H	H	H	o-biphenyl	
E-133	p-biphenyl	H	H	H	H	o-biphenyl	o-biphenyl	
E-134	p-biphenyl	H	H	H	H	m-biphenyl	H	
E-135	p-biphenyl	H	H	H	H	H	m-biphenyl	
E-136	p-biphenyl	H	H	H	H	m-biphenyl	m-biphenyl	
E-137	p-biphenyl	H	H	H	H	p-biphenyl	H	
E-138	p-biphenyl	H	H	H	H	H	p-biphenyl	
E-139	p-biphenyl	H	H	H	H	p-biphenyl	p-biphenyl	

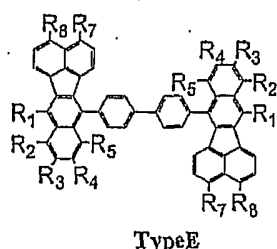

	R ₁	R ₂	R ₃	R ₄	R ₅	R ₇	R ₈
E-140	o-tolyl	H	H	H	H	H	H
E-141	o-tolyl	Ph	H	H	Ph	H	H
E-142	o-tolyl	H	Ph	Ph	H	H	H
E-143	o-tolyl	H	H	H	H	Ph	H
E-144	o-tolyl	H	H	H	H	H	Ph
E-145	o-tolyl	H	H	H	H	1-naphthyl	H
E-146	o-tolyl	H	H	H	H	H	1-naphthyl
E-147	o-tolyl	H	H	H	H	2-naphthyl	H
E-148	o-tolyl	H	H	H	H	H	2-naphthyl
E-149	o-tolyl	H	H	H	H	o-biphenyl	H
E-150	o-tolyl	H	H	H	H	H	o-biphenyl
E-151	o-tolyl	H	H	H	H	m-biphenyl	H
E-152	o-tolyl	H	H	H	H	H	m-biphenyl
E-153	o-tolyl	H	H	H	H	p-biphenyl	H
E-154	o-tolyl	H	H	H	H	H	p-biphenyl
E-155	o-tolyl	H	H	H	H	o-tolyl	H
E-156	o-tolyl	H	H	H	H	H	o-tolyl
E-157	m-tolyl	H	H	H	H	H	H
E-158	m-tolyl	Ph	H	H	Ph	H	H
E-159	m-tolyl	H	Ph	Ph	H	H	H
E-160	m-tolyl	H	H	H	H	Ph	H
E-161	m-tolyl	H	H	H	H	H	Ph
E-162	m-tolyl	H	H	H	H	1-naphthyl	H
E-163	m-tolyl	H	H	H	H	H	1-naphthyl
E-164	m-tolyl	H	H	H	H	2-naphthyl	H
E-165	m-tolyl	H	H	H	H	H	2-naphthyl
E-166	m-tolyl	H	H	H	H	o-biphenyl	H
E-167	m-tolyl	H	H	H	H	H	o-biphenyl
E-168	m-tolyl	H	H	H	H	m-biphenyl	H
E-169	m-tolyl	H	H	H	H	H	m-biphenyl
E-170	m-tolyl	H	H	H	H	p-biphenyl	H
E-171	m-tolyl	H	H	H	H	H	p-biphenyl
E-172	m-tolyl	H	H	H	H	m-tolyl	H
E-173	m-tolyl	H	H	H	H	H	m-tolyl
E-174	p-tolyl	H	H	H	H	H	H
E-175	p-tolyl	Ph	H	H	Ph	H	H
E-176	p-tolyl	H	Ph	Ph	H	H	H
E-177	p-tolyl	H	H	H	H	Ph	H
E-178	p-tolyl	H	H	H	H	H	Ph
E-179	p-tolyl	H	H	H	H	1-naphthyl	H
E-180	p-tolyl	H	H	H	H	H	1-naphthyl
E-181	p-tolyl	H	H	H	H	2-naphthyl	H
E-182	p-tolyl	H	H	H	H	H	2-naphthyl
E-183	p-tolyl	H	H	H	H	o-biphenyl	H
E-184	p-tolyl	H	H	H	H	H	o-biphenyl
E-185	p-tolyl	H	H	H	H	m-biphenyl	H
E-186	p-tolyl	H	H	H	H	H	m-biphenyl
E-187	p-tolyl	H	H	H	H	p-biphenyl	H
E-188	p-tolyl	H	H	H	H	H	p-biphenyl
E-189	p-tolyl	H	H	H	H	p-tolyl	H
E-190	p-tolyl	H	H	H	H	H	p-tolyl

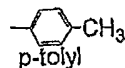
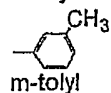
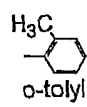
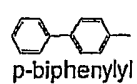
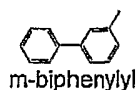
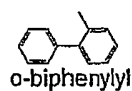
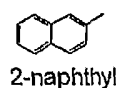
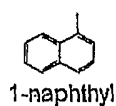

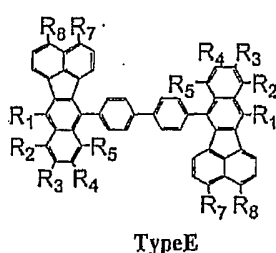

	R ₁	R ₂	R ₃	R ₄	R ₅	R ₇	R ₈
E-191	Ph	H	-CH3	-CH3	H	H	H
E-192	1-naphthyl	H	-CH3	-CH3	H	H	H
E-193	2-naphthyl	H	-CH3	-CH3	H	H	H
E-194	o-biphenyl	H	-CH3	-CH3	H	H	H
E-195	m-biphenyl	H	-CH3	-CH3	H	H	H
E-196	p-biphenyl	H	-CH3	-CH3	H	H	H
E-197	o-tolyl	H	-CH3	-CH3	H	H	H
E-198	m-tolyl	H	-CH3	-CH3	H	H	H
E-199	p-tolyl	H	-CH3	-CH3	H	H	H
E-200	Ph	H	H	H	H	-CH3	H
E-201	1-naphthyl	H	H	H	H	-CH3	H
E-202	2-naphthyl	H	H	H	H	-CH3	H
E-203	o-biphenyl	H	H	H	H	-CH3	H
E-204	m-biphenyl	H	H	H	H	-CH3	H
E-205	p-biphenyl	H	H	H	H	-CH3	H
E-206	o-tolyl	H	H	H	H	-CH3	H
E-207	m-tolyl	H	H	H	H	-CH3	H
E-208	p-tolyl	H	H	H	H	-CH3	H
E-209	Ph	H	H	H	H	H	-CH3
E-210	1-naphthyl	H	H	H	H	H	-CH3
E-211	2-naphthyl	H	H	H	H	H	-CH3
E-212	o-biphenyl	H	H	H	H	H	-CH3
E-213	m-biphenyl	H	H	H	H	H	-CH3
E-214	p-biphenyl	H	H	H	H	H	-CH3
E-215	o-tolyl	H	H	H	H	H	-CH3
E-216	m-tolyl	H	H	H	H	H	-CH3
E-217	p-tolyl	H	H	H	H	H	-CH3
E-218	Ph	H	H	H	H	-CH3	-CH3
E-219	1-naphthyl	H	H	H	H	-CH3	-CH3
E-220	2-naphthyl	H	H	H	H	-CH3	-CH3
E-221	o-biphenyl	H	H	H	H	-CH3	-CH3
E-222	m-biphenyl	H	H	H	H	-CH3	-CH3
E-223	p-biphenyl	H	H	H	H	-CH3	-CH3
E-224	o-tolyl	H	H	H	H	-CH3	-CH3
E-225	m-tolyl	H	H	H	H	-CH3	-CH3
E-226	p-tolyl	H	H	H	H	-CH3	-CH3
E-227	Ph	H	H	H	H	H	DPA
E-228	1-naphthyl	H	H	H	H	H	DPA
E-229	2-naphthyl	H	H	H	H	H	DPA
E-230	o-biphenyl	H	H	H	H	H	DPA
E-231	m-biphenyl	H	H	H	H	H	DPA
E-232	p-biphenyl	H	H	H	H	H	DPA
E-233	Ph	H	H	H	H	DPA	H
E-234	1-naphthyl	H	H	H	H	DPA	H
E-235	2-naphthyl	H	H	H	H	DPA	H
E-236	o-biphenyl	H	H	H	H	DPA	H
E-237	m-biphenyl	H	H	H	H	DPA	H
E-238	p-biphenyl	H	H	H	H	DPA	H
E-239	Ph	H	H	H	H	H	TPA
E-240	1-naphthyl	H	H	H	H	H	TPA
E-241	2-naphthyl	H	H	H	H	H	TPA
E-242	o-biphenyl	H	H	H	H	H	TPA
E-243	m-biphenyl	H	H	H	H	H	TPA
E-244	p-biphenyl	H	H	H	H	H	TPA
E-245	Ph	H	H	H	H	TPA	H
E-246	1-naphthyl	H	H	H	H	TPA	H
E-247	2-naphthyl	H	H	H	H	TPA	H
E-248	o-biphenyl	H	H	H	H	TPA	H
E-249	m-biphenyl	H	H	H	H	TPA	H
E-250	p-biphenyl	H	H	H	H	TPA	H

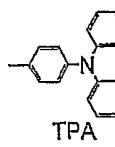
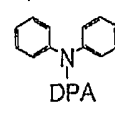
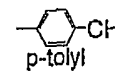
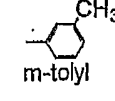
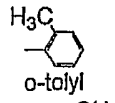
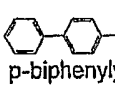
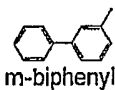
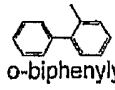
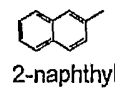
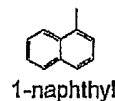

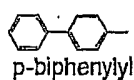
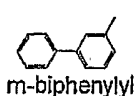
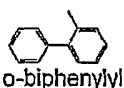
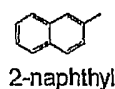
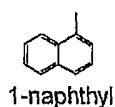
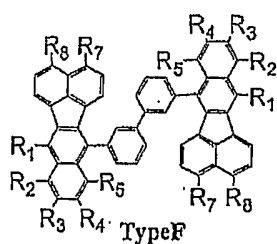

	R ₁	R ₂	R ₃	R ₄	R ₅	R ₇	R ₈
F-1	H	H	H	H	H	H	H
F-2	Ph	H	H	H	H	H	H
F-3	Ph	Ph	H	H	Ph	H	H
F-4	Ph	H	Ph	Ph	H	H	H
F-5	Ph	H	Ph	H	H	H	H
F-6	Ph	H	H	Ph	H	H	H
F-7	Ph	H	H	H	H	Ph	H
F-8	Ph	H	H	H	H	H	Ph
F-9	Ph	H	H	H	H	Ph	Ph
F-10	Ph	H	H	H	H	1-naphthyl	H
F-11	Ph	H	H	H	H	H	1-naphthyl
F-12	Ph	H	H	H	H	1-naphthyl	1-naphthyl
F-13	Ph	H	H	H	H	2-naphthyl	H
F-14	Ph	H	H	H	H	H	2-naphthyl
F-15	Ph	H	H	H	H	2-naphthyl	2-naphthyl
F-16	Ph	H	H	H	H	o-biphenyl	H
F-17	Ph	H	H	H	H	H	o-biphenyl
F-18	Ph	H	H	H	H	o-biphenyl	o-biphenyl
F-19	Ph	H	H	H	H	m-biphenyl	H
F-20	Ph	H	H	H	H	H	m-biphenyl
F-21	Ph	H	H	H	H	m-biphenyl	m-biphenyl
F-22	Ph	H	H	H	H	p-biphenyl	H
F-23	Ph	H	H	H	H	H	p-biphenyl
F-24	Ph	H	H	H	H	p-biphenyl	p-biphenyl
F-25	1-naphthyl	H	H	H	H	H	H
F-26	1-naphthyl	Ph	H	H	Ph	H	H
F-27	1-naphthyl	H	Ph	Ph	H	H	H
F-28	1-naphthyl	H	Ph	H	H	H	H
F-29	1-naphthyl	H	H	Ph	H	H	H
F-30	1-naphthyl	H	H	H	H	Ph	H
F-31	1-naphthyl	H	H	H	H	H	Ph
F-32	1-naphthyl	H	H	H	H	Ph	Ph
F-33	1-naphthyl	H	H	H	H	1-naphthyl	H
F-34	1-naphthyl	H	H	H	H	H	1-naphthyl
F-35	1-naphthyl	H	H	H	H	1-naphthyl	1-naphthyl
F-36	1-naphthyl	H	H	H	H	2-naphthyl	H
F-37	1-naphthyl	H	H	H	H	H	2-naphthyl
F-38	1-naphthyl	H	H	H	H	2-naphthyl	2-naphthyl
F-39	1-naphthyl	H	H	H	H	o-biphenyl	H
F-40	1-naphthyl	H	H	H	H	H	o-biphenyl
F-41	1-naphthyl	H	H	H	H	o-biphenyl	o-biphenyl
F-42	1-naphthyl	H	H	H	H	m-biphenyl	H
F-43	1-naphthyl	H	H	H	H	H	m-biphenyl
F-44	1-naphthyl	H	H	H	H	m-biphenyl	m-biphenyl
F-45	1-naphthyl	H	H	H	H	p-biphenyl	H
F-46	1-naphthyl	H	H	H	H	H	p-biphenyl
F-47	1-naphthyl	H	H	H	H	p-biphenyl	p-biphenyl

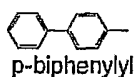
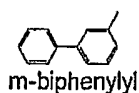
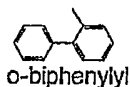
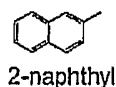
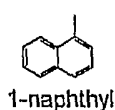
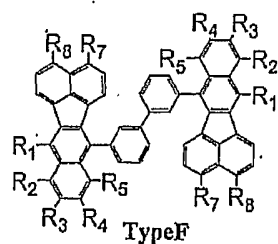

	R ₁	R ₂	R ₃	R ₄	R ₅	R ₇	R ₈
F-48	2-naphthyl	H	H	H	H	H	H
F-49	2-naphthyl	Ph	H	H	Ph	H	H
F-50	2-naphthyl	H	Ph	Ph	H	H	H
F-51	2-naphthyl	H	Ph	H	H	H	H
F-52	2-naphthyl	H	H	Ph	H	H	H
F-53	2-naphthyl	H	H	H	H	Ph	H
F-54	2-naphthyl	H	H	H	H	H	Ph
F-55	2-naphthyl	H	H	H	H	Ph	Ph
F-56	2-naphthyl	H	H	H	H	1-naphthyl	H
F-57	2-naphthyl	H	H	H	H	H	1-naphthyl
F-58	2-naphthyl	H	H	H	H	1-naphthyl	1-naphthyl
F-59	2-naphthyl	H	H	H	H	2-naphthyl	H
F-60	2-naphthyl	H	H	H	H	H	2-naphthyl
F-61	2-naphthyl	H	H	H	H	2-naphthyl	2-naphthyl
F-62	2-naphthyl	H	H	H	H	o-biphenyl	H
F-63	2-naphthyl	H	H	H	H	H	o-biphenyl
F-64	2-naphthyl	H	H	H	H	o-biphenyl	o-biphenyl
F-65	2-naphthyl	H	H	H	H	m-biphenyl	H
F-66	2-naphthyl	H	H	H	H	H	m-biphenyl
F-67	2-naphthyl	H	H	H	H	m-biphenyl	m-biphenyl
F-68	2-naphthyl	H	H	H	H	p-biphenyl	H
F-69	2-naphthyl	H	H	H	H	H	p-biphenyl
F-70	2-naphthyl	H	H	H	H	p-biphenyl	p-biphenyl
F-71	o-biphenyl	H	H	H	H	H	H
F-72	o-biphenyl	Ph	H	H	Ph	H	H
F-73	o-biphenyl	H	Ph	Ph	H	H	H
F-74	o-biphenyl	H	Ph	H	H	H	H
F-75	o-biphenyl	H	H	Ph	H	H	H
F-76	o-biphenyl	H	H	H	H	Ph	H
F-77	o-biphenyl	H	H	H	H	H	Ph
F-78	o-biphenyl	H	H	H	H	Ph	Ph
F-79	o-biphenyl	H	H	H	H	1-naphthyl	H
F-80	o-biphenyl	H	H	H	H	H	1-naphthyl
F-81	o-biphenyl	H	H	H	H	1-naphthyl	1-naphthyl
F-82	o-biphenyl	H	H	H	H	2-naphthyl	H
F-83	o-biphenyl	H	H	H	H	H	2-naphthyl
F-84	o-biphenyl	H	H	H	H	2-naphthyl	2-naphthyl
F-85	o-biphenyl	H	H	H	H	o-biphenyl	H
F-86	o-biphenyl	H	H	H	H	H	o-biphenyl
F-87	o-biphenyl	H	H	H	H	o-biphenyl	o-biphenyl
F-88	o-biphenyl	H	H	H	H	m-biphenyl	H
F-89	o-biphenyl	H	H	H	H	H	m-biphenyl
F-90	o-biphenyl	H	H	H	H	m-biphenyl	m-biphenyl
F-91	o-biphenyl	H	H	H	H	p-biphenyl	H
F-92	o-biphenyl	H	H	H	H	H	p-biphenyl
F-93	o-biphenyl	H	H	H	H	p-biphenyl	p-biphenyl

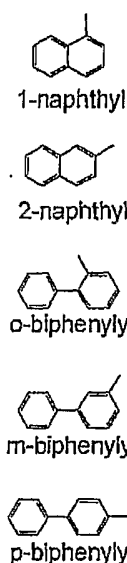
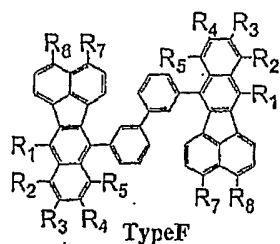

	R ₁	R ₂	R ₃	R ₄	R ₅	R ₇	R ₈
F-94	m-biphenyl	H	H	H	H	H	H
F-95	m-biphenyl	Ph	H	H	Ph	H	H
F-96	m-biphenyl	H	Ph	Ph	H	H	H
F-97	m-biphenyl	H	Ph	H	H	H	H
F-98	m-biphenyl	H	H	Ph	H	H	H
F-99	m-biphenyl	H	H	H	H	Ph	H
F-100	m-biphenyl	H	H	H	H	H	Ph
F-101	m-biphenyl	H	H	H	H	Ph	Ph
F-102	m-biphenyl	H	H	H	H	1-naphthyl	H
F-103	m-biphenyl	H	H	H	H	H	1-naphthyl
F-104	m-biphenyl	H	H	H	H	1-naphthyl	1-naphthyl
F-105	m-biphenyl	H	H	H	H	2-naphthyl	H
F-106	m-biphenyl	H	H	H	H	H	2-naphthyl
F-107	m-biphenyl	H	H	H	H	2-naphthyl	2-naphthyl
F-108	m-biphenyl	H	H	H	H	o-biphenyl	H
F-109	m-biphenyl	H	H	H	H	H	o-biphenyl
F-110	m-biphenyl	H	H	H	H	o-biphenyl	o-biphenyl
F-111	m-biphenyl	H	H	H	H	m-biphenyl	H
F-112	m-biphenyl	H	H	H	H	H	m-biphenyl
F-113	m-biphenyl	H	H	H	H	m-biphenyl	m-biphenyl
F-114	m-biphenyl	H	H	H	H	p-biphenyl	H
F-115	m-biphenyl	H	H	H	H	H	p-biphenyl
F-116	m-biphenyl	H	H	H	H	p-biphenyl	p-biphenyl
F-117	p-biphenyl	H	H	H	H	H	H
F-118	p-biphenyl	Ph	H	H	Ph	H	H
F-119	p-biphenyl	H	Ph	Ph	H	H	H
F-120	p-biphenyl	H	Ph	H	H	H	H
F-121	p-biphenyl	H	H	Ph	H	H	H
F-122	p-biphenyl	H	H	H	H	Ph	H
F-123	p-biphenyl	H	H	H	H	H	Ph
F-124	p-biphenyl	H	H	H	H	Ph	Ph
F-125	p-biphenyl	H	H	H	H	1-naphthyl	H
F-126	p-biphenyl	H	H	H	H	H	1-naphthyl
F-127	p-biphenyl	H	H	H	H	1-naphthyl	1-naphthyl
F-128	p-biphenyl	H	H	H	H	2-naphthyl	H
F-129	p-biphenyl	H	H	H	H	H	2-naphthyl
F-130	p-biphenyl	H	H	H	H	2-naphthyl	2-naphthyl
F-131	p-biphenyl	H	H	H	H	o-biphenyl	H
F-132	p-biphenyl	H	H	H	H	H	o-biphenyl
F-133	p-biphenyl	H	H	H	H	o-biphenyl	o-biphenyl
F-134	p-biphenyl	H	H	H	H	m-biphenyl	H
F-135	p-biphenyl	H	H	H	H	H	m-biphenyl
F-136	p-biphenyl	H	H	H	H	m-biphenyl	m-biphenyl
F-137	p-biphenyl	H	H	H	H	p-biphenyl	H
F-138	p-biphenyl	H	H	H	H	H	p-biphenyl
F-139	p-biphenyl	H	H	H	H	p-biphenyl	p-biphenyl

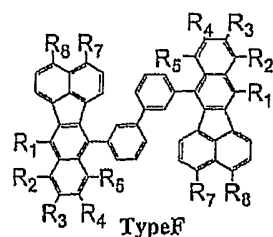

	R ₁	R ₂	R ₃	R ₄	R ₅	R ₇	R ₈
F-140	o-tolyl	H	H	H	H	H	H
F-141	o-tolyl	Ph	H	H	Ph	H	H
F-142	o-tolyl	H	Ph	Ph	H	H	H
F-143	o-tolyl	H	H	H	H	Ph	H
F-144	o-tolyl	H	H	H	H	H	Ph
F-145	o-tolyl	H	H	H	H	1-naphthyl	H
F-146	o-tolyl	H	H	H	H	H	1-naphthyl
F-147	o-tolyl	H	H	H	H	2-naphthyl	H
F-148	o-tolyl	H	H	H	H	H	2-naphthyl
F-149	o-tolyl	H	H	H	H	o-biphenyl	H
F-150	o-tolyl	H	H	H	H	H	o-biphenyl
F-151	o-tolyl	H	H	H	H	m-biphenyl	H
F-152	o-tolyl	H	H	H	H	H	m-biphenyl
F-153	o-tolyl	H	H	H	H	p-biphenyl	H
E-154	o-tolyl	H	H	H	H	H	p-biphenyl
F-155	o-tolyl	H	H	H	H	o-tolyl	H
F-156	o-tolyl	H	H	H	H	H	o-tolyl
F-157	m-tolyl	H	H	H	H	H	H
F-158	m-tolyl	Ph	H	H	Ph	H	H
F-159	m-tolyl	H	Ph	Ph	H	H	H
E-160	m-tolyl	H	H	H	H	Ph	H
F-161	m-tolyl	H	H	H	H	H	Ph
F-162	m-tolyl	H	H	H	H	1-naphthyl	H
F-163	m-tolyl	H	H	H	H	H	1-naphthyl
F-164	m-tolyl	H	H	H	H	2-naphthyl	H
F-165	m-tolyl	H	H	H	H	H	2-naphthyl
F-166	m-tolyl	H	H	H	H	o-biphenyl	H
F-167	m-tolyl	H	H	H	H	H	o-biphenyl
F-168	m-tolyl	H	H	H	H	m-biphenyl	H
F-169	m-tolyl	H	H	H	H	H	m-biphenyl
F-170	m-tolyl	H	H	H	H	p-biphenyl	H
F-171	m-tolyl	H	H	H	H	H	p-biphenyl
F-172	m-tolyl	H	H	H	H	m-tolyl	H
F-173	m-tolyl	H	H	H	H	H	m-tolyl
F-174	p-tolyl	H	H	H	H	H	H
F-175	p-tolyl	Ph	H	H	Ph	H	H
F-176	p-tolyl	H	Ph	Ph	H	H	H
F-177	p-tolyl	H	H	H	H	Ph	H
F-178	p-tolyl	H	H	H	H	H	Ph
F-179	p-tolyl	H	H	H	H	1-naphthyl	H
F-180	p-tolyl	H	H	H	H	H	1-naphthyl
F-181	p-tolyl	H	H	H	H	2-naphthyl	H
F-182	p-tolyl	H	H	H	H	H	2-naphthyl
F-183	p-tolyl	H	H	H	H	o-biphenyl	H
F-184	p-tolyl	H	H	H	H	H	o-biphenyl
F-185	p-tolyl	H	H	H	H	m-biphenyl	H
F-186	p-tolyl	H	H	H	H	H	m-biphenyl
F-187	p-tolyl	H	H	H	H	p-biphenyl	H
F-188	p-tolyl	H	H	H	H	H	p-biphenyl
F-189	p-tolyl	H	H	H	H	p-tolyl	H
F-190	p-tolyl	H	H	H	H	H	p-tolyl

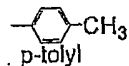
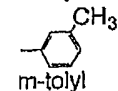
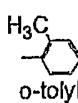
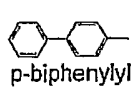
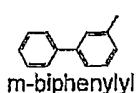
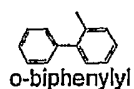
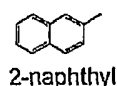
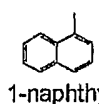

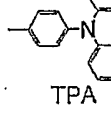
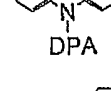
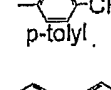
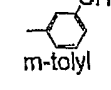
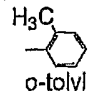
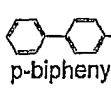
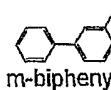
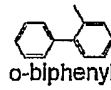
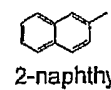
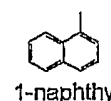
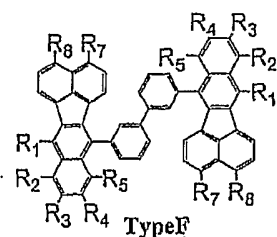

	R ₁	R ₂	R ₃	R ₄	R ₅	R ₇	R ₈
F-191	Ph	H	-CH3	-CH3	H	H	H
F-192	1-naphthyl	H	-CH3	-CH3	H	H	H
F-193	2-naphthyl	H	-CH3	-CH3	H	H	H
F-194	o-biphenyl	H	-CH3	-CH3	H	H	H
F-195	m-biphenyl	H	-CH3	-CH3	H	H	H
F-196	p-biphenyl	H	-CH3	-CH3	H	H	H
F-197	o-tolyl	H	-CH3	-CH3	H	H	H
F-198	m-tolyl	H	-CH3	-CH3	H	H	H
F-199	p-tolyl	H	-CH3	-CH3	H	H	H
F-200	Ph	H	H	H	H	-CH3	H
F-201	1-naphthyl	H	H	H	H	-CH3	H
F-202	2-naphthyl	H	H	H	H	-CH3	H
F-203	o-biphenyl	H	H	H	H	-CH3	H
F-204	m-biphenyl	H	H	H	H	-CH3	H
F-205	p-biphenyl	H	H	H	H	-CH3	H
F-206	o-tolyl	H	H	H	H	-CH3	H
F-207	m-tolyl	H	H	H	H	-CH3	H
E-208	p-tolyl	H	H	H	H	-CH3	H
F-209	Ph	H	H	H	H	H	-CH3
F-210	1-naphthyl	H	H	H	H	H	-CH3
F-211	2-naphthyl	H	H	H	H	H	-CH3
F-212	o-biphenyl	H	H	H	H	H	-CH3
F-213	m-biphenyl	H	H	H	H	H	-CH3
F-214	p-biphenyl	H	H	H	H	H	-CH3
F-215	o-tolyl	H	H	H	H	H	-CH3
F-216	m-tolyl	H	H	H	H	H	-CH3
F-217	p-tolyl	H	H	H	H	H	-CH3
F-218	Ph	H	H	H	H	-CH3	-CH3
F-219	1-naphthyl	H	H	H	H	-CH3	-CH3
F-220	2-naphthyl	H	H	H	H	-CH3	-CH3
F-221	o-biphenyl	H	H	H	H	-CH3	-CH3
F-222	m-biphenyl	H	H	H	H	-CH3	-CH3
F-223	p-biphenyl	H	H	H	H	-CH3	-CH3
F-224	o-tolyl	H	H	H	H	-CH3	-CH3
F-225	m-tolyl	H	H	H	H	-CH3	-CH3
F-226	p-tolyl	H	H	H	H	-CH3	-CH3
F-227	Ph	H	H	H	H	H	DPA
F-228	1-naphthyl	H	H	H	H	H	DPA
F-229	2-naphthyl	H	H	H	H	H	DPA
F-230	o-biphenyl	H	H	H	H	H	DPA
F-231	m-biphenyl	H	H	H	H	H	DPA
F-232	p-biphenyl	H	H	H	H	H	DPA
F-233	Ph	H	H	H	H	DPA	H
F-234	1-naphthyl	H	H	H	H	DPA	H
F-235	2-naphthyl	H	H	H	H	DPA	H
F-236	o-biphenyl	H	H	H	H	DPA	H
F-237	m-biphenyl	H	H	H	H	DPA	H
F-238	p-biphenyl	H	H	H	H	DPA	H
F-239	Ph	H	H	H	H	H	TPA
F-240	1-naphthyl	H	H	H	H	H	TPA
F-241	2-naphthyl	H	H	H	H	H	TPA
F-242	o-biphenyl	H	H	H	H	H	TPA
F-243	m-biphenyl	H	H	H	H	H	TPA
F-244	p-biphenyl	H	H	H	H	H	TPA
F-245	Ph	H	H	H	H	TPA	H
F-246	1-naphthyl	H	H	H	H	TPA	H
F-247	2-naphthyl	H	H	H	H	TPA	H
F-248	o-biphenyl	H	H	H	H	TPA	H
F-249	m-biphenyl	H	H	H	H	TPA	H
F-250	p-biphenyl	H	H	H	H	TPA	H

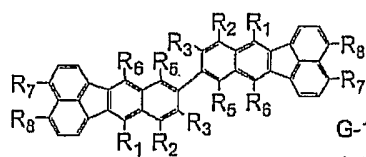

TypeG

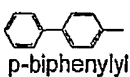
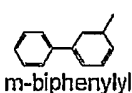
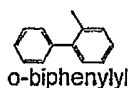
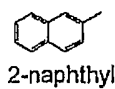
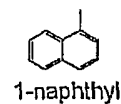

	R ₁	R ₂	R ₃	R ₅	R ₆	R ₇	R ₈
G-1	H	H	H	H	H	H	H
G-2	Ph	H	H	H	Ph	H	H
G-3	Ph	Ph	H	H	Ph	H	H
G-4	Ph	H	H	Ph	Ph	H	H
G-5	Ph	Ph	H	Ph	Ph	H	H
G-6	Ph	H	Ph	H	Ph	H	H
G-7	Ph	H	H	H	Ph	Ph	H
G-8	Ph	H	H	H	Ph	H	Ph
G-9	Ph	H	H	H	Ph	Ph	Ph
G-10	Ph	H	H	H	Ph	1-naphthyl	H
G-11	Ph	H	H	H	Ph	H	1-naphthyl
G-12	Ph	H	H	H	Ph	1-naphthyl	1-naphthyl
G-13	Ph	H	H	H	Ph	2-naphthyl	H
G-14	Ph	H	H	H	Ph	H	2-naphthyl
G-15	Ph	H	H	H	Ph	2-naphthyl	2-naphthyl
G-16	Ph	H	H	H	Ph	o-biphenyl	H
G-17	Ph	H	H	H	Ph	H	o-biphenyl
G-18	Ph	H	H	H	Ph	o-biphenyl	o-biphenyl
G-19	Ph	H	H	H	Ph	m-biphenyl	H
G-20	Ph	H	H	H	Ph	H	m-biphenyl
G-21	Ph	H	H	H	Ph	m-biphenyl	m-biphenyl
G-22	Ph	H	H	H	Ph	p-biphenyl	H
G-23	Ph	H	H	H	Ph	H	p-biphenyl
G-24	Ph	H	H	H	Ph	p-biphenyl	p-biphenyl
G-25	1-naphthyl	H	H	H	1-naphthyl	H	H
G-26	1-naphthyl	Ph	H	H	1-naphthyl	H	H
G-27	1-naphthyl	H	H	Ph	1-naphthyl	H	H
G-28	1-naphthyl	Ph	H	Ph	1-naphthyl	H	H
G-29	1-naphthyl	H	Ph	H	1-naphthyl	H	H
G-30	1-naphthyl	H	H	H	1-naphthyl	Ph	H
G-31	1-naphthyl	H	H	H	1-naphthyl	H	Ph
G-32	1-naphthyl	H	H	H	1-naphthyl	Ph	Ph
G-33	1-naphthyl	H	H	H	1-naphthyl	1-naphthyl	H
G-34	1-naphthyl	H	H	H	1-naphthyl	H	1-naphthyl
G-35	1-naphthyl	H	H	H	1-naphthyl	1-naphthyl	1-naphthyl
G-36	1-naphthyl	H	H	H	1-naphthyl	2-naphthyl	H
G-37	1-naphthyl	H	H	H	1-naphthyl	H	2-naphthyl
G-38	1-naphthyl	H	H	H	1-naphthyl	2-naphthyl	2-naphthyl
G-39	1-naphthyl	H	H	H	1-naphthyl	o-biphenyl	H
G-40	1-naphthyl	H	H	H	1-naphthyl	H	o-biphenyl
G-41	1-naphthyl	H	H	H	1-naphthyl	o-biphenyl	o-biphenyl
G-42	1-naphthyl	H	H	H	1-naphthyl	m-biphenyl	H
G-43	1-naphthyl	H	H	H	1-naphthyl	H	m-biphenyl
G-44	1-naphthyl	H	H	H	1-naphthyl	m-biphenyl	m-biphenyl
G-45	1-naphthyl	H	H	H	1-naphthyl	p-biphenyl	H
G-46	1-naphthyl	H	H	H	1-naphthyl	H	p-biphenyl
G-47	1-naphthyl	H	H	H	1-naphthyl	p-biphenyl	p-biphenyl

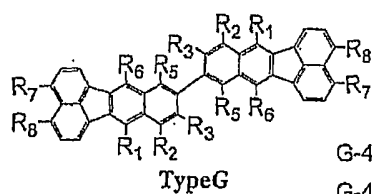

	R ₁	R ₂	R ₃	R ₅	R ₆	R ₇	R ₈
G-48	2-naphthyl	H	H	H	2-naphthyl	H	H
G-49	2-naphthyl	Ph	H	H	2-naphthyl	H	H
G-50	2-naphthyl	H	H	Ph	2-naphthyl	H	H
G-51	2-naphthyl	Ph	H	Ph	2-naphthyl	H	H
G-52	2-naphthyl	H	Ph	H	2-naphthyl	H	H
G-53	2-naphthyl	H	H	H	2-naphthyl	Ph	H
G-54	2-naphthyl	H	H	H	2-naphthyl	H	Ph
G-55	2-naphthyl	H	H	H	2-naphthyl	Ph	Ph
G-56	2-naphthyl	H	H	H	2-naphthyl	1-naphthyl	H
G-57	2-naphthyl	H	H	H	2-naphthyl	H	1-naphthyl
G-58	2-naphthyl	H	H	H	2-naphthyl	1-naphthyl	1-naphthyl
G-59	2-naphthyl	H	H	H	2-naphthyl	2-naphthyl	H
G-60	2-naphthyl	H	H	H	2-naphthyl	H	2-naphthyl
G-61	2-naphthyl	H	H	H	2-naphthyl	2-naphthyl	2-naphthyl
G-62	2-naphthyl	H	H	H	2-naphthyl	o-biphenyl	H
G-63	2-naphthyl	H	H	H	2-naphthyl	H	o-biphenyl
G-64	2-naphthyl	H	H	H	2-naphthyl	o-biphenyl	o-biphenyl
G-65	2-naphthyl	H	H	H	2-naphthyl	m-biphenyl	H
G-66	2-naphthyl	H	H	H	2-naphthyl	H	m-biphenyl
G-67	2-naphthyl	H	H	H	2-naphthyl	m-biphenyl	m-biphenyl
G-68	2-naphthyl	H	H	H	2-naphthyl	p-biphenyl	H
G-69	2-naphthyl	H	H	H	2-naphthyl	H	p-biphenyl
G-70	2-naphthyl	H	H	H	2-naphthyl	p-biphenyl	p-biphenyl
G-71	o-biphenyl	H	H	H	o-biphenyl	H	H
G-72	o-biphenyl	Ph	H	H	o-biphenyl	H	H
G-73	o-biphenyl	H	H	Ph	o-biphenyl	H	H
G-74	o-biphenyl	Ph	H	Ph	o-biphenyl	H	H
G-75	o-biphenyl	H	Ph	H	o-biphenyl	H	H
G-76	o-biphenyl	H	H	H	o-biphenyl	Ph	H
G-77	o-biphenyl	H	H	H	o-biphenyl	H	Ph
G-78	o-biphenyl	H	H	H	o-biphenyl	Ph	Ph
G-79	o-biphenyl	H	H	H	o-biphenyl	1-naphthyl	H
G-80	o-biphenyl	H	H	H	o-biphenyl	H	1-naphthyl
G-81	o-biphenyl	H	H	H	o-biphenyl	1-naphthyl	1-naphthyl
G-82	o-biphenyl	H	H	H	o-biphenyl	2-naphthyl	H
G-83	o-biphenyl	H	H	H	o-biphenyl	H	2-naphthyl
G-84	o-biphenyl	H	H	H	o-biphenyl	2-naphthyl	2-naphthyl
G-85	o-biphenyl	H	H	H	o-biphenyl	o-biphenyl	H
G-86	o-biphenyl	H	H	H	o-biphenyl	H	o-biphenyl
G-87	o-biphenyl	H	H	H	o-biphenyl	o-biphenyl	o-biphenyl
G-88	o-biphenyl	H	H	H	o-biphenyl	m-biphenyl	H
G-89	o-biphenyl	H	H	H	o-biphenyl	H	m-biphenyl
G-90	o-biphenyl	H	H	H	o-biphenyl	m-biphenyl	m-biphenyl
G-91	o-biphenyl	H	H	H	o-biphenyl	p-biphenyl	H
G-92	o-biphenyl	H	H	H	o-biphenyl	H	p-biphenyl
G-93	o-biphenyl	H	H	H	o-biphenyl	p-biphenyl	p-biphenyl

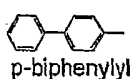
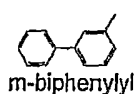
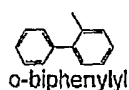
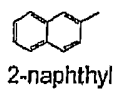
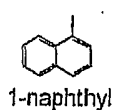

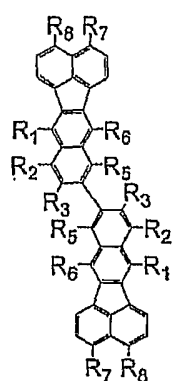

Type G

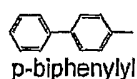
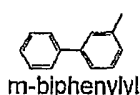
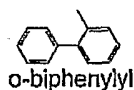
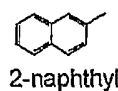
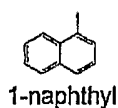

	R ₁	R ₂	R ₃	R ₅	R ₆	R ₇	R ₈
G-94	m-biphenyl	H	H	H	m-biphenyl	H	H
G-95	m-biphenyl	Ph	H	H	m-biphenyl	H	H
G-96	m-biphenyl	H	H	Ph	m-biphenyl	H	H
G-97	m-biphenyl	Ph	H	Ph	m-biphenyl	H	H
G-98	m-biphenyl	H	Ph	H	m-biphenyl	H	H
G-99	m-biphenyl	H	H	H	m-biphenyl	Ph	H
G-100	m-biphenyl	H	H	H	m-biphenyl	H	Ph
G-101	m-biphenyl	H	H	H	m-biphenyl	Ph	Ph
G-102	m-biphenyl	H	H	H	m-biphenyl	1-naphthyl	H
G-103	m-biphenyl	H	H	H	m-biphenyl	H	1-naphthyl
G-104	m-biphenyl	H	H	H	m-biphenyl	1-naphthyl	1-naphthyl
G-105	m-biphenyl	H	H	H	m-biphenyl	2-naphthyl	H
G-106	m-biphenyl	H	H	H	m-biphenyl	H	2-naphthyl
G-107	m-biphenyl	H	H	H	m-biphenyl	2-naphthyl	2-naphthyl
G-108	m-biphenyl	H	H	H	m-biphenyl	o-biphenyl	H
G-109	m-biphenyl	H	H	H	m-biphenyl	H	o-biphenyl
G-110	m-biphenyl	H	H	H	m-biphenyl	o-biphenyl	o-biphenyl
G-111	m-biphenyl	H	H	H	m-biphenyl	m-biphenyl	H
G-112	m-biphenyl	H	H	H	m-biphenyl	H	m-biphenyl
G-113	m-biphenyl	H	H	H	m-biphenyl	m-biphenyl	m-biphenyl
G-114	m-biphenyl	H	H	H	m-biphenyl	p-biphenyl	H
G-115	m-biphenyl	H	H	H	m-biphenyl	H	p-biphenyl
G-116	m-biphenyl	H	H	H	m-biphenyl	p-biphenyl	p-biphenyl
G-117	p-biphenyl	H	H	H	p-biphenyl	H	H
G-118	p-biphenyl	Ph	H	H	p-biphenyl	H	H
G-119	p-biphenyl	H	H	Ph	p-biphenyl	H	H
G-120	p-biphenyl	Ph	H	Ph	p-biphenyl	H	H
G-121	p-biphenyl	H	Ph	H	p-biphenyl	H	H
G-122	p-biphenyl	H	H	H	p-biphenyl	Ph	H
G-123	p-biphenyl	H	H	H	p-biphenyl	H	Ph
G-124	p-biphenyl	H	H	H	p-biphenyl	Ph	Ph
G-125	p-biphenyl	H	H	H	p-biphenyl	1-naphthyl	H
G-126	p-biphenyl	H	H	H	p-biphenyl	H	1-naphthyl
G-127	p-biphenyl	H	H	H	p-biphenyl	1-naphthyl	1-naphthyl
G-128	p-biphenyl	H	H	H	p-biphenyl	2-naphthyl	H
G-129	p-biphenyl	H	H	H	p-biphenyl	H	2-naphthyl
G-130	p-biphenyl	H	H	H	p-biphenyl	2-naphthyl	2-naphthyl
G-131	p-biphenyl	H	H	H	p-biphenyl	o-biphenyl	H
G-132	p-biphenyl	H	H	H	p-biphenyl	H	o-biphenyl
G-133	p-biphenyl	H	H	H	p-biphenyl	o-biphenyl	o-biphenyl
G-134	p-biphenyl	H	H	H	p-biphenyl	m-biphenyl	H
G-135	p-biphenyl	H	H	H	p-biphenyl	H	m-biphenyl
G-136	p-biphenyl	H	H	H	p-biphenyl	m-biphenyl	m-biphenyl
G-137	p-biphenyl	H	H	H	p-biphenyl	p-biphenyl	H
G-138	p-biphenyl	H	H	H	p-biphenyl	H	p-biphenyl
G-139	p-biphenyl	H	H	H	p-biphenyl	p-biphenyl	p-biphenyl

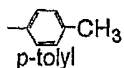
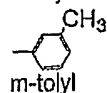
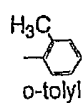
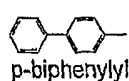
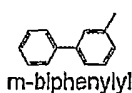
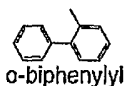
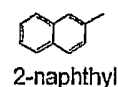
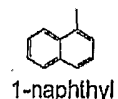
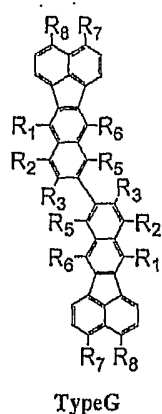

	R ₁	R ₂	R ₃	R ₅	R ₆	R ₇	R ₈
G-140	o-tolyl	H	H	H	o-tolyl	H	H
G-141	o-tolyl	Ph	H	Ph	o-tolyl	H	H
G-142	o-tolyl	H	Ph	H	o-tolyl	H	H
G-143	o-tolyl	H	H	H	o-tolyl	Ph	H
G-144	o-tolyl	H	H	H	o-tolyl	H	Ph
G-145	o-tolyl	H	H	H	o-tolyl	1-naphthyl	H
G-146	o-tolyl	H	H	H	o-tolyl	H	1-naphthyl
G-147	o-tolyl	H	H	H	o-tolyl	2-naphthyl	H
G-148	o-tolyl	H	H	H	o-tolyl	H	2-naphthyl
G-149	o-tolyl	H	H	H	o-tolyl	o-biphenylyl	H
G-150	o-tolyl	H	H	H	o-tolyl	H	o-biphenylyl
G-151	o-tolyl	H	H	H	o-tolyl	m-biphenylyl	H
G-152	o-tolyl	H	H	H	o-tolyl	H	m-biphenylyl
G-153	o-tolyl	H	H	H	o-tolyl	p-biphenylyl	H
G-154	o-tolyl	H	H	H	o-tolyl	H	p-biphenylyl
G-155	o-tolyl	H	H	H	o-tolyl	o-tolyl	H
G-156	o-tolyl	H	H	H	o-tolyl	H	o-tolyl
G-157	m-tolyl	H	H	H	m-tolyl	H	H
G-158	m-tolyl	Ph	H	Ph	m-tolyl	H	H
G-159	m-tolyl	H	Ph	H	m-tolyl	H	H
G-160	m-tolyl	H	H	H	m-tolyl	Ph	H
G-161	m-tolyl	H	H	H	m-tolyl	H	Ph
G-162	m-tolyl	H	H	H	m-tolyl	1-naphthyl	H
G-163	m-tolyl	H	H	H	m-tolyl	H	1-naphthyl
G-164	m-tolyl	H	H	H	m-tolyl	2-naphthyl	H
G-165	m-tolyl	H	H	H	m-tolyl	H	2-naphthyl
G-166	m-tolyl	H	H	H	m-tolyl	o-biphenylyl	H
G-167	m-tolyl	H	H	H	m-tolyl	H	o-biphenylyl
G-168	m-tolyl	H	H	H	m-tolyl	m-biphenylyl	H
G-169	m-tolyl	H	H	H	m-tolyl	H	m-biphenylyl
G-170	m-tolyl	H	H	H	m-tolyl	p-biphenylyl	H
G-171	m-tolyl	H	H	H	m-tolyl	H	p-biphenylyl
G-172	m-tolyl	H	H	H	m-tolyl	m-tolyl	H
G-173	m-tolyl	H	H	H	m-tolyl	H	m-tolyl
G-174	p-tolyl	H	H	H	p-tolyl	H	H
G-175	p-tolyl	Ph	H	Ph	p-tolyl	H	H
G-176	p-tolyl	H	Ph	H	p-tolyl	H	H
G-177	p-tolyl	H	H	H	p-tolyl	Ph	H
G-178	p-tolyl	H	H	H	p-tolyl	H	Ph
G-179	p-tolyl	H	H	H	p-tolyl	1-naphthyl	H
G-180	p-tolyl	H	H	H	p-tolyl	H	1-naphthyl
G-181	p-tolyl	H	H	H	p-tolyl	2-naphthyl	H
G-182	p-tolyl	H	H	H	p-tolyl	H	2-naphthyl
G-183	p-tolyl	H	H	H	p-tolyl	o-biphenylyl	H
G-184	p-tolyl	H	H	H	p-tolyl	H	o-biphenylyl
G-185	p-tolyl	H	H	H	p-tolyl	m-biphenylyl	H
G-186	p-tolyl	H	H	H	p-tolyl	H	m-biphenylyl
G-187	p-tolyl	H	H	H	p-tolyl	p-biphenylyl	H
G-188	p-tolyl	H	H	H	p-tolyl	H	p-biphenylyl
G-189	p-tolyl	H	H	H	p-tolyl	p-tolyl	H
G-190	p-tolyl	H	H	H	p-tolyl	H	p-tolyl

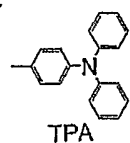
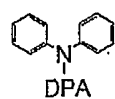
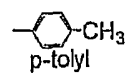
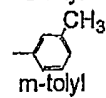
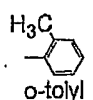
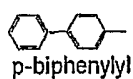
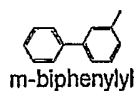
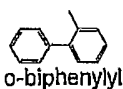
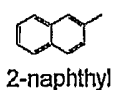
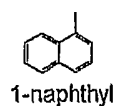
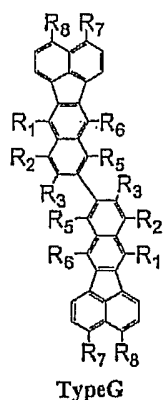

	R ₁	R ₂	R ₃	R ₅	R ₆	R ₇	R ₈
G-191	Ph	H	-CH3	H	Ph	H	H
G-192	1-naphthyl	H	-CH3	H	1-naphthyl	H	H
G-193	2-naphthyl	H	-CH3	H	2-naphthyl	H	H
G-194	o-biphenyl	H	-CH3	H	o-biphenyl	H	H
G-195	m-biphenyl	H	-CH3	H	m-biphenyl	H	H
G-196	p-biphenyl	H	-CH3	H	p-biphenyl	H	H
G-197	o-tolyl	H	-CH3	H	o-tolyl	H	H
G-198	m-tolyl	H	-CH3	H	m-tolyl	H	H
G-199	p-tolyl	H	-CH3	H	p-tolyl	H	H
G-200	Ph	H	H	H	Ph	-CH3	H
G-201	1-naphthyl	H	H	H	1-naphthyl	-CH3	H
G-202	2-naphthyl	H	H	H	2-naphthyl	-CH3	H
G-203	o-biphenyl	H	H	H	o-biphenyl	-CH3	H
G-204	m-biphenyl	H	H	H	m-biphenyl	-CH3	H
G-205	p-biphenyl	H	H	H	p-biphenyl	-CH3	H
G-206	o-tolyl	H	H	H	o-tolyl	-CH3	H
G-207	m-tolyl	H	H	H	m-tolyl	-CH3	H
G-208	p-tolyl	H	H	H	p-tolyl	-CH3	H
G-209	Ph	H	H	H	Ph	H	-CH3
G-210	1-naphthyl	H	H	H	1-naphthyl	H	-CH3
G-211	2-naphthyl	H	H	H	2-naphthyl	H	-CH3
G-212	o-biphenyl	H	H	H	o-biphenyl	H	-CH3
G-213	m-biphenyl	H	H	H	m-biphenyl	H	-CH3
G-214	p-biphenyl	H	H	H	p-biphenyl	H	-CH3
G-215	o-tolyl	H	H	H	o-tolyl	H	-CH3
G-216	m-tolyl	H	H	H	m-tolyl	H	-CH3
G-217	p-tolyl	H	H	H	p-tolyl	H	-CH3
G-218	Ph	H	H	H	Ph	-CH3	-CH3
G-219	1-naphthyl	H	H	H	1-naphthyl	-CH3	-CH3
G-220	2-naphthyl	H	H	H	2-naphthyl	-CH3	-CH3
G-221	o-biphenyl	H	H	H	o-biphenyl	-CH3	-CH3
G-222	m-biphenyl	H	H	H	m-biphenyl	-CH3	-CH3
G-223	p-biphenyl	H	H	H	p-biphenyl	-CH3	-CH3
G-224	o-tolyl	H	H	H	o-tolyl	-CH3	-CH3
G-225	m-tolyl	H	H	H	m-tolyl	-CH3	-CH3
G-226	p-tolyl	H	H	H	p-tolyl	-CH3	-CH3
G-227	Ph	H	H	H	Ph	H	DPA
G-228	1-naphthyl	H	H	H	1-naphthyl	H	DPA
G-229	2-naphthyl	H	H	H	2-naphthyl	H	DPA
G-230	o-biphenyl	H	H	H	o-biphenyl	H	DPA
G-231	m-biphenyl	H	H	H	m-biphenyl	H	DPA
G-232	p-biphenyl	H	H	H	p-biphenyl	H	DPA
G-233	Ph	H	H	H	Ph	DPA	H
G-234	1-naphthyl	H	H	H	1-naphthyl	DPA	H
G-235	2-naphthyl	H	H	H	2-naphthyl	DPA	H
G-236	o-biphenyl	H	H	H	o-biphenyl	DPA	H
G-237	m-biphenyl	H	H	H	m-biphenyl	DPA	H
G-238	p-biphenyl	H	H	H	p-biphenyl	DPA	H
G-239	Ph	H	H	H	Ph	H	TPA
G-240	1-naphthyl	H	H	H	1-naphthyl	H	TPA
G-241	2-naphthyl	H	H	H	2-naphthyl	H	TPA
G-242	o-biphenyl	H	H	H	o-biphenyl	H	TPA
G-243	m-biphenyl	H	H	H	m-biphenyl	H	TPA
G-244	p-biphenyl	H	H	H	p-biphenyl	H	TPA
G-245	Ph	H	H	H	Ph	TPA	H
G-246	1-naphthyl	H	H	H	1-naphthyl	TPA	H
G-247	2-naphthyl	H	H	H	2-naphthyl	TPA	H
G-248	o-biphenyl	H	H	H	o-biphenyl	TPA	H
G-249	m-biphenyl	H	H	H	m-biphenyl	TPA	H
G-250	p-biphenyl	H	H	H	p-biphenyl	TPA	H

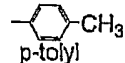
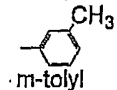
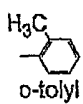
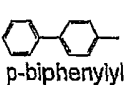
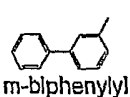
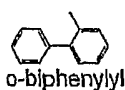
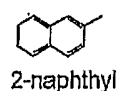
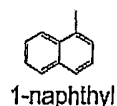
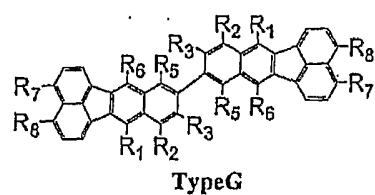

	R ₁	R ₂	R ₃	R ₅	R ₆	R ₇	R ₈
G-251	Ph	H	H	H	1-naphthyl	H	H
G-252	Ph	H	H	H	2-naphthyl	H	H
G-253	Ph	H	H	H	o-biphenyl	H	H
G-254	Ph	H	H	H	m-biphenyl	H	H
G-255	Ph	H	H	H	p-biphenyl	H	H
G-256	Ph	H	H	H	O-tolyl	H	H
G-257	Ph	H	H	H	m-tolyl	H	H
G-258	Ph	H	H	H	p-tolyl	H	H
G-259	1-naphthyl	H	H	H	2-naphthyl	H	H
G-260	1-naphthyl	H	H	H	o-biphenyl	H	H
G-261	1-naphthyl	H	H	H	m-biphenyl	H	H
G-262	1-naphthyl	H	H	H	p-biphenyl	H	H
G-263	1-naphthyl	H	H	H	O-tolyl	H	H
G-264	1-naphthyl	H	H	H	m-tolyl	H	H
G-265	1-naphthyl	H	H	H	p-tolyl	H	H
G-266	2-naphthyl	H	H	H	o-biphenyl	H	H
G-267	2-naphthyl	H	H	H	m-biphenyl	H	H
G-268	2-naphthyl	H	H	H	p-biphenyl	H	H
G-269	2-naphthyl	H	H	H	O-tolyl	H	H
G-270	2-naphthyl	H	H	H	m-tolyl	H	H
G-271	2-naphthyl	H	H	H	p-tolyl	H	H
G-272	o-biphenyl	H	H	H	m-biphenyl	H	H
G-273	o-biphenyl	H	H	H	p-biphenyl	H	H
G-274	o-biphenyl	H	H	H	O-tolyl	H	H
G-275	o-biphenyl	H	H	H	m-tolyl	H	H
G-276	o-biphenyl	H	H	H	p-tolyl	H	H
G-277	m-biphenyl	H	H	H	p-biphenyl	H	H
G-278	m-biphenyl	H	H	H	O-tolyl	H	H
G-279	m-biphenyl	H	H	H	m-tolyl	H	H
G-280	m-biphenyl	H	H	H	p-tolyl	H	H
G-281	p-biphenyl	H	H	H	O-tolyl	H	H
G-282	p-biphenyl	H	H	H	m-tolyl	H	H
G-283	p-biphenyl	H	H	H	p-tolyl	H	H
G-284	O-tolyl	H	H	H	m-tolyl	H	H
G-285	O-tolyl	H	H	H	p-tolyl	H	H
G-286	m-tolyl	H	H	H	p-tolyl	H	H

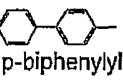
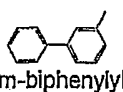
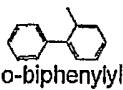
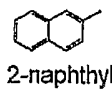
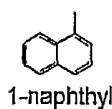
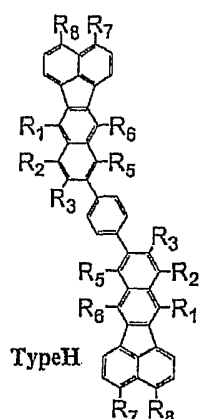

	R ₁	R ₂	R ₃	R ₅	R ₆	R ₇	R ₈
H-1	H	H	H	H	H	H	H
H-2	Ph	H	H	H	Ph	H	H
H-3	Ph	Ph	H	H	Ph	H	H
H-4	Ph	H	H	Ph	Ph	H	H
H-5	Ph	Ph	H	Ph	Ph	H	H
H-6	Ph	H	Ph	H	Ph	H	H
H-7	Ph	H	H	H	Ph	Ph	H
H-8	Ph	H	H	H	Ph	H	Ph
H-9	Ph	H	H	H	Ph	Ph	Ph
H-10	Ph	H	H	H	Ph	1-naphthyl	H
H-11	Ph	H	H	H	Ph	H	1-naphthyl
H-12	Ph	H	H	H	Ph	1-naphthyl	1-naphthyl
H-13	Ph	H	H	H	Ph	2-naphthyl	H
H-14	Ph	H	H	H	Ph	H	2-naphthyl
H-15	Ph	H	H	H	Ph	2-naphthyl	2-naphthyl
H-16	Ph	H	H	H	Ph	o-biphenyl	H
H-17	Ph	H	H	H	Ph	H	o-biphenyl
H-18	Ph	H	H	H	Ph	o-biphenyl	o-biphenyl
H-19	Ph	H	H	H	Ph	m-biphenyl	H
H-20	Ph	H	H	H	Ph	H	m-biphenyl
H-21	Ph	H	H	H	Ph	m-biphenyl	m-biphenyl
H-22	Ph	H	H	H	Ph	p-biphenyl	H
H-23	Ph	H	H	H	Ph	H	p-biphenyl
H-24	Ph	H	H	H	Ph	p-biphenyl	p-biphenyl
H-25	1-naphthyl	H	H	H	1-naphthyl	H	H
H-26	1-naphthyl	Ph	H	H	1-naphthyl	H	H
H-27	1-naphthyl	H	H	Ph	1-naphthyl	H	H
H-28	1-naphthyl	Ph	H	Ph	1-naphthyl	H	H
H-29	1-naphthyl	H	Ph	H	1-naphthyl	H	H
H-30	1-naphthyl	H	H	H	1-naphthyl	Ph	H
H-31	1-naphthyl	H	H	H	1-naphthyl	H	Ph
H-32	1-naphthyl	H	H	H	1-naphthyl	Ph	Ph
H-33	1-naphthyl	H	H	H	1-naphthyl	1-naphthyl	H
H-34	1-naphthyl	H	H	H	1-naphthyl	H	1-naphthyl
H-35	1-naphthyl	H	H	H	1-naphthyl	1-naphthyl	1-naphthyl
H-36	1-naphthyl	H	H	H	1-naphthyl	2-naphthyl	H
H-37	1-naphthyl	H	H	H	1-naphthyl	H	2-naphthyl
H-38	1-naphthyl	H	H	H	1-naphthyl	2-naphthyl	2-naphthyl
H-39	1-naphthyl	H	H	H	1-naphthyl	o-biphenyl	H
H-40	1-naphthyl	H	H	H	1-naphthyl	H	o-biphenyl
H-41	1-naphthyl	H	H	H	1-naphthyl	o-biphenyl	o-biphenyl
H-42	1-naphthyl	H	H	H	1-naphthyl	m-biphenyl	H
H-43	1-naphthyl	H	H	H	1-naphthyl	H	m-biphenyl
H-44	1-naphthyl	H	H	H	1-naphthyl	m-biphenyl	m-biphenyl
H-45	1-naphthyl	H	H	H	1-naphthyl	p-biphenyl	H
H-46	1-naphthyl	H	H	H	1-naphthyl	H	p-biphenyl
H-47	1-naphthyl	H	H	H	1-naphthyl	p-biphenyl	p-biphenyl

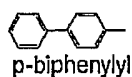
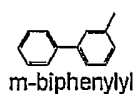
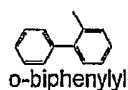
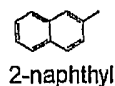
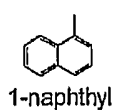
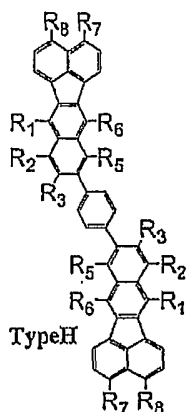

	R ₁	R ₂	R ₃	R ₅	R ₆	R ₇	R ₈
H-48	2-naphthyl	H	H	H	2-naphthyl	H	H
H-49	2-naphthyl	Ph	H	H	2-naphthyl	H	H
H-50	2-naphthyl	H	H	Ph	2-naphthyl	H	H
H-51	2-naphthyl	Ph	H	Ph	2-naphthyl	H	H
H-52	2-naphthyl	H	Ph	H	2-naphthyl	H	H
H-53	2-naphthyl	H	H	H	2-naphthyl	Ph	H
H-54	2-naphthyl	H	H	H	2-naphthyl	H	Ph
H-55	2-naphthyl	H	H	H	2-naphthyl	Ph	Ph
H-56	2-naphthyl	H	H	H	2-naphthyl	1-naphthyl	H
H-57	2-naphthyl	H	H	H	2-naphthyl	H	1-naphthyl
H-58	2-naphthyl	H	H	H	2-naphthyl	1-naphthyl	1-naphthyl
H-59	2-naphthyl	H	H	H	2-naphthyl	2-naphthyl	H
H-60	2-naphthyl	H	H	H	2-naphthyl	H	2-naphthyl
H-61	2-naphthyl	H	H	H	2-naphthyl	2-naphthyl	2-naphthyl
H-62	2-naphthyl	H	H	H	2-naphthyl	o-biphenylyl	H
H-63	2-naphthyl	H	H	H	2-naphthyl	H	o-biphenylyl
H-64	2-naphthyl	H	H	H	2-naphthyl	o-biphenylyl	o-biphenylyl
H-65	2-naphthyl	H	H	H	2-naphthyl	m-biphenylyl	H
H-66	2-naphthyl	H	H	H	2-naphthyl	H	m-biphenylyl
H-67	2-naphthyl	H	H	H	2-naphthyl	m-biphenylyl	m-biphenylyl
H-68	2-naphthyl	H	H	H	2-naphthyl	p-biphenylyl	H
H-69	2-naphthyl	H	H	H	2-naphthyl	H	p-biphenylyl
H-70	2-naphthyl	H	H	H	2-naphthyl	p-biphenylyl	p-biphenylyl
H-71	o-biphenylyl	H	H	H	o-biphenylyl	H	H
H-72	o-biphenylyl	Ph	H	H	o-biphenylyl	H	H
H-73	o-biphenylyl	H	H	Ph	o-biphenylyl	H	H
H-74	o-biphenylyl	Ph	H	Ph	o-biphenylyl	H	H
H-75	o-biphenylyl	H	Ph	H	o-biphenylyl	H	H
H-76	o-biphenylyl	H	H	H	o-biphenylyl	Ph	H
H-77	o-biphenylyl	H	H	H	o-biphenylyl	H	Ph
H-78	o-biphenylyl	H	H	H	o-biphenylyl	Ph	Ph
H-79	o-biphenylyl	H	H	H	o-biphenylyl	1-naphthyl	H
H-80	o-biphenylyl	H	H	H	o-biphenylyl	H	1-naphthyl
H-81	o-biphenylyl	H	H	H	o-biphenylyl	1-naphthyl	1-naphthyl
H-82	o-biphenylyl	H	H	H	o-biphenylyl	2-naphthyl	H
H-83	o-biphenylyl	H	H	H	o-biphenylyl	H	2-naphthyl
H-84	o-biphenylyl	H	H	H	o-biphenylyl	2-naphthyl	2-naphthyl
H-85	o-biphenylyl	H	H	H	o-biphenylyl	o-biphenylyl	H
H-86	o-biphenylyl	H	H	H	o-biphenylyl	H	o-biphenylyl
H-87	o-biphenylyl	H	H	H	o-biphenylyl	o-biphenylyl	o-biphenylyl
H-88	o-biphenylyl	H	H	H	o-biphenylyl	m-biphenylyl	H
H-89	o-biphenylyl	H	H	H	o-biphenylyl	H	m-biphenylyl
H-90	o-biphenylyl	H	H	H	o-biphenylyl	m-biphenylyl	m-biphenylyl
H-91	o-biphenylyl	H	H	H	o-biphenylyl	p-biphenylyl	H
H-92	o-biphenylyl	H	H	H	o-biphenylyl	H	p-biphenylyl
H-93	o-biphenylyl	H	H	H	o-biphenylyl	p-biphenylyl	p-biphenylyl

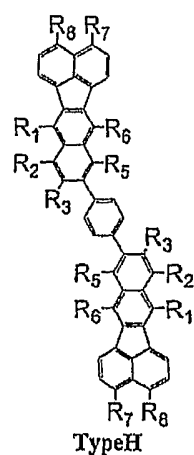

	R ₁	R ₂	R ₃	R ₅	R ₆	R ₇	R ₈
H-94	m-biphenyl	H	H	H	m-biphenyl	H	H
H-95	m-biphenyl	Ph	H	H	m-biphenyl	H	H
H-96	m-biphenyl	H	H	Ph	m-biphenyl	H	H
H-97	m-biphenyl	Ph	H	Ph	m-biphenyl	H	H
H-98	m-biphenyl	H	Ph	H	m-biphenyl	H	H
H-99	m-biphenyl	H	H	H	m-biphenyl	Ph	H
H-100	m-biphenyl	H	H	H	m-biphenyl	H	Ph
H-101	m-biphenyl	H	H	H	m-biphenyl	Ph	Ph
H-102	m-biphenyl	H	H	H	m-biphenyl	1-naphthyl	H
H-103	m-biphenyl	H	H	H	m-biphenyl	H	1-naphthyl
H-104	m-biphenyl	H	H	H	m-biphenyl	1-naphthyl	1-naphthyl
H-105	m-biphenyl	H	H	H	m-biphenyl	2-naphthyl	H
H-106	m-biphenyl	H	H	H	m-biphenyl	H	2-naphthyl
H-107	m-biphenyl	H	H	H	m-biphenyl	2-naphthyl	2-naphthyl
H-108	m-biphenyl	H	H	H	m-biphenyl	o-biphenyl	H
H-109	m-biphenyl	H	H	H	m-biphenyl	H	o-biphenyl
H-110	m-biphenyl	H	H	H	m-biphenyl	o-biphenyl	o-biphenyl
H-111	m-biphenyl	H	H	H	m-biphenyl	m-biphenyl	H
H-112	m-biphenyl	H	H	H	m-biphenyl	H	m-biphenyl
H-113	m-biphenyl	H	H	H	m-biphenyl	m-biphenyl	m-biphenyl
H-114	m-biphenyl	H	H	H	m-biphenyl	p-biphenyl	H
H-115	m-biphenyl	H	H	H	m-biphenyl	H	p-biphenyl
H-116	m-biphenyl	H	H	H	m-biphenyl	p-biphenyl	p-biphenyl
H-117	p-biphenyl	H	H	H	p-biphenyl	H	H
H-118	p-biphenyl	Ph	H	H	p-biphenyl	H	H
H-119	p-biphenyl	H	H	Ph	p-biphenyl	H	H
H-120	p-biphenyl	Ph	H	Ph	p-biphenyl	H	H
H-121	p-biphenyl	H	Ph	H	p-biphenyl	H	H
H-122	p-biphenyl	H	H	H	p-biphenyl	Ph	H
H-123	p-biphenyl	H	H	H	p-biphenyl	H	Ph
H-124	p-biphenyl	H	H	H	p-biphenyl	Ph	Ph
H-125	p-biphenyl	H	H	H	p-biphenyl	1-naphthyl	H
H-126	p-biphenyl	H	H	H	p-biphenyl	H	1-naphthyl
H-127	p-biphenyl	H	H	H	p-biphenyl	1-naphthyl	1-naphthyl
H-128	p-biphenyl	H	H	H	p-biphenyl	2-naphthyl	H
H-129	p-biphenyl	H	H	H	p-biphenyl	H	2-naphthyl
H-130	p-biphenyl	H	H	H	p-biphenyl	2-naphthyl	2-naphthyl
H-131	p-biphenyl	H	H	H	p-biphenyl	o-biphenyl	H
H-132	p-biphenyl	H	H	H	p-biphenyl	H	o-biphenyl
H-133	p-biphenyl	H	H	H	p-biphenyl	o-biphenyl	o-biphenyl
H-134	p-biphenyl	H	H	H	p-biphenyl	m-biphenyl	H
H-135	p-biphenyl	H	H	H	p-biphenyl	H	m-biphenyl
H-136	p-biphenyl	H	H	H	p-biphenyl	m-biphenyl	m-biphenyl
H-137	p-biphenyl	H	H	H	p-biphenyl	p-biphenyl	H
H-138	p-biphenyl	H	H	H	p-biphenyl	H	p-biphenyl
H-139	p-biphenyl	H	H	H	p-biphenyl	p-biphenyl	p-biphenyl

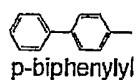
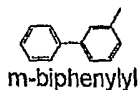
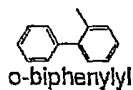
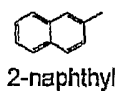
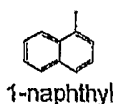

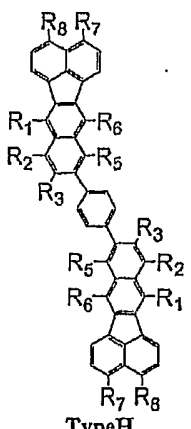
	R ₁	R ₂	R ₃	R ₅	R ₆	R ₇	R ₈
 <p>Type H</p>	H-140	o-tolyl	H	H	H	o-tolyl	H
	H-141	o-tolyl	Ph	H	Ph	o-tolyl	H
	H-142	o-tolyl	H	Ph	H	o-tolyl	H
	H-143	o-tolyl	H	H	H	o-tolyl	Ph
	H-144	o-tolyl	H	H	H	o-tolyl	H
	H-145	o-tolyl	H	H	H	o-tolyl	1-naphthyl
	H-146	o-tolyl	H	H	H	o-tolyl	H
	H-147	o-tolyl	H	H	H	o-tolyl	2-naphthyl
	H-148	o-tolyl	H	H	H	o-tolyl	H
	H-149	o-tolyl	H	H	H	o-tolyl	o-biphenyl
	H-150	o-tolyl	H	H	H	o-tolyl	H
	H-151	o-tolyl	H	H	H	o-tolyl	m-biphenyl
	H-152	o-tolyl	H	H	H	o-tolyl	H
	H-153	o-tolyl	H	H	H	o-tolyl	p-biphenyl
	H-154	o-tolyl	H	H	H	o-tolyl	H
H-155	o-tolyl	H	H	H	o-tolyl	o-tolyl	
H-156	o-tolyl	H	H	H	o-tolyl	H	
H-157	m-tolyl	H	H	H	m-tolyl	H	
H-158	m-tolyl	Ph	H	Ph	m-tolyl	H	
H-159	m-tolyl	H	Ph	H	m-tolyl	H	
H-160	m-tolyl	H	H	H	m-tolyl	Ph	
H-161	m-tolyl	H	H	H	m-tolyl	H	
H-162	m-tolyl	H	H	H	m-tolyl	1-naphthyl	
H-163	m-tolyl	H	H	H	m-tolyl	H	
H-164	m-tolyl	H	H	H	m-tolyl	2-naphthyl	
H-165	m-tolyl	H	H	H	m-tolyl	H	
H-166	m-tolyl	H	H	H	m-tolyl	o-biphenyl	
H-167	m-tolyl	H	H	H	m-tolyl	H	
H-168	m-tolyl	H	H	H	m-tolyl	m-biphenyl	
H-169	m-tolyl	H	H	H	m-tolyl	H	
H-170	m-tolyl	H	H	H	m-tolyl	p-biphenyl	
H-171	m-tolyl	H	H	H	m-tolyl	H	
H-172	m-tolyl	H	H	H	m-tolyl	m-tolyl	
H-173	m-tolyl	H	H	H	m-tolyl	H	
H-174	p-tolyl	H	H	H	p-tolyl	H	
H-175	p-tolyl	Ph	H	Ph	p-tolyl	H	
H-176	p-tolyl	H	Ph	H	p-tolyl	H	
H-177	p-tolyl	H	H	H	p-tolyl	Ph	
H-178	p-tolyl	H	H	H	p-tolyl	H	
H-179	p-tolyl	H	H	H	p-tolyl	1-naphthyl	
H-180	p-tolyl	H	H	H	p-tolyl	H	
H-181	p-tolyl	H	H	H	p-tolyl	2-naphthyl	
H-182	p-tolyl	H	H	H	p-tolyl	H	
H-183	p-tolyl	H	H	H	p-tolyl	o-biphenyl	
H-184	p-tolyl	H	H	H	p-tolyl	H	
H-185	p-tolyl	H	H	H	p-tolyl	m-biphenyl	
H-186	p-tolyl	H	H	H	p-tolyl	H	
H-187	p-tolyl	H	H	H	p-tolyl	p-biphenyl	
H-188	p-tolyl	H	H	H	p-tolyl	H	
H-189	p-tolyl	H	H	H	p-tolyl	p-tolyl	
H-190	p-tolyl	H	H	H	p-tolyl	H	

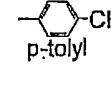
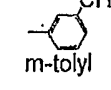
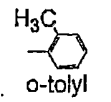
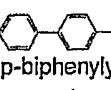
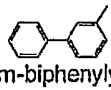
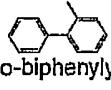
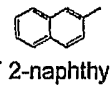
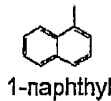

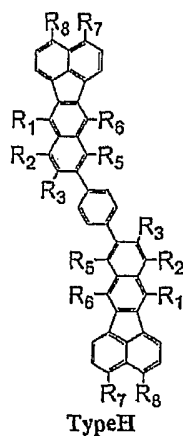

1-naphthyl

2-naphthyl

o-biphenyl

m-biphenyl

p-biphenyl

o-tolyl

m-tolyl







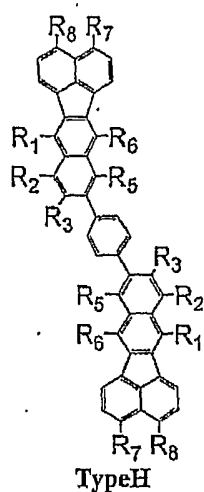

p-tolyl

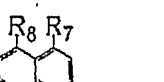
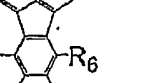
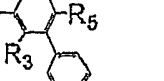
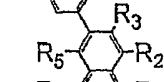
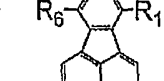
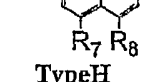
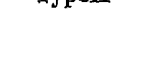
DPA

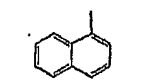
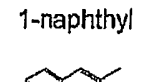
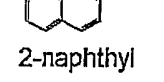
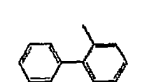
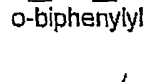
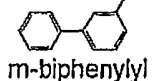
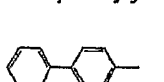
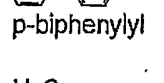
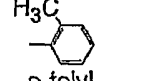
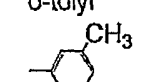
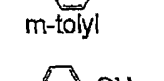
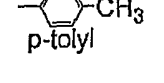
TPA

	R ₁	R ₂	R ₃	R ₅	R ₆	R ₇	R ₈
H-191	Ph	H	-CH ₃	H	Ph	H	H
H-192	1-naphthyl	H	-CH ₃	H	1-naphthyl	H	H
H-193	2-naphthyl	H	-CH ₃	H	2-naphthyl	H	H
H-194	o-biphenyl	H	-CH ₃	H	o-biphenyl	H	H
H-195	m-biphenyl	H	-CH ₃	H	m-biphenyl	H	H
H-196	p-biphenyl	H	-CH ₃	H	p-biphenyl	H	H
H-197	o-tolyl	H	-CH ₃	H	o-tolyl	H	H
H-198	m-tolyl	H	-CH ₃	H	m-tolyl	H	H
H-199	p-tolyl	H	-CH ₃	H	p-tolyl	H	H
H-200	Ph	H	H	H	Ph	-CH ₃	H
H-201	1-naphthyl	H	H	H	1-naphthyl	-CH ₃	H
H-202	2-naphthyl	H	H	H	2-naphthyl	-CH ₃	H
H-203	o-biphenyl	H	H	H	o-biphenyl	-CH ₃	H
H-204	m-biphenyl	H	H	H	m-biphenyl	-CH ₃	H
H-205	p-biphenyl	H	H	H	p-biphenyl	-CH ₃	H
H-206	o-tolyl	H	H	H	o-tolyl	-CH ₃	H
H-207	m-tolyl	H	H	H	m-tolyl	-CH ₃	H
H-208	p-tolyl	H	H	H	p-tolyl	-CH ₃	H
H-209	Ph	H	H	H	Ph	H	-CH ₃
H-210	1-naphthyl	H	H	H	1-naphthyl	H	-CH ₃
H-211	2-naphthyl	H	H	H	2-naphthyl	H	-CH ₃
H-212	o-biphenyl	H	H	H	o-biphenyl	H	-CH ₃
H-213	m-biphenyl	H	H	H	m-biphenyl	H	-CH ₃
H-214	p-biphenyl	H	H	H	p-biphenyl	H	-CH ₃
H-215	o-tolyl	H	H	H	o-tolyl	H	-CH ₃
H-216	m-tolyl	H	H	H	m-tolyl	H	-CH ₃
H-217	p-tolyl	H	H	H	p-tolyl	H	-CH ₃
H-218	Ph	H	H	H	Ph	-CH ₃	-CH ₃
H-219	1-naphthyl	H	H	H	1-naphthyl	-CH ₃	-CH ₃
H-220	2-naphthyl	H	H	H	2-naphthyl	-CH ₃	-CH ₃
H-221	o-biphenyl	H	H	H	o-biphenyl	-CH ₃	-CH ₃
H-222	m-biphenyl	H	H	H	m-biphenyl	-CH ₃	-CH ₃
H-223	p-biphenyl	H	H	H	p-biphenyl	-CH ₃	-CH ₃
H-224	o-tolyl	H	H	H	o-tolyl	-CH ₃	-CH ₃
H-225	m-tolyl	H	H	H	m-tolyl	-CH ₃	-CH ₃
H-226	p-tolyl	H	H	H	p-tolyl	-CH ₃	-CH ₃
H-227	Ph	H	H	H	Ph	H	DPA
H-228	1-naphthyl	H	H	H	1-naphthyl	H	DPA
H-229	2-naphthyl	H	H	H	2-naphthyl	H	DPA
H-230	o-biphenyl	H	H	H	o-biphenyl	H	DPA
H-231	m-biphenyl	H	H	H	m-biphenyl	H	DPA
H-232	p-biphenyl	H	H	H	p-biphenyl	H	DPA
H-233	Ph	H	H	H	Ph	DPA	H
H-234	1-naphthyl	H	H	H	1-naphthyl	DPA	H
H-235	2-naphthyl	H	H	H	2-naphthyl	DPA	H
H-236	o-biphenyl	H	H	H	o-biphenyl	DPA	H
H-237	m-biphenyl	H	H	H	m-biphenyl	DPA	H
H-238	p-biphenyl	H	H	H	p-biphenyl	DPA	H
H-239	Ph	H	H	H	Ph	H	TPA
H-240	1-naphthyl	H	H	H	1-naphthyl	H	TPA
H-241	2-naphthyl	H	H	H	2-naphthyl	H	TPA
H-242	o-biphenyl	H	H	H	o-biphenyl	H	TPA
H-243	m-biphenyl	H	H	H	m-biphenyl	H	TPA
H-244	p-biphenyl	H	H	H	p-biphenyl	H	TPA
H-245	Ph	H	H	H	Ph	TPA	H
H-246	1-naphthyl	H	H	H	1-naphthyl	TPA	H
H-247	2-naphthyl	H	H	H	2-naphthyl	TPA	H
H-248	o-biphenyl	H	H	H	o-biphenyl	TPA	H
H-249	m-biphenyl	H	H	H	m-biphenyl	TPA	H
H-250	p-biphenyl	H	H	H	p-biphenyl	TPA	H



	R ₁	R ₂	R ₃	R ₅	R ₆	R ₇	R ₈	
	H-251	Ph	H	H	H	1-naphthyl	H	H
	H-252	Ph	H	H	H	2-naphthyl	H	H
	H-253	Ph	H	H	H	o-biphenyl	H	H
	H-254	Ph	H	H	H	m-biphenyl	H	H
	H-255	Ph	H	H	H	p-biphenyl	H	H
	H-256	Ph	H	H	H	O-tolyl	H	H
	H-257	Ph	H	H	H	m-tolyl	H	H
	H-258	Ph	H	H	H	p-tolyl	H	H
	H-259	1-naphthyl	H	H	H	2-naphthyl	H	H
	H-260	1-naphthyl	H	H	H	o-biphenyl	H	H
	H-261	1-naphthyl	H	H	H	m-biphenyl	H	H
	H-262	1-naphthyl	H	H	H	p-biphenyl	H	H
	H-263	1-naphthyl	H	H	H	O-tolyl	H	H
	H-264	1-naphthyl	H	H	H	m-tolyl	H	H
	H-265	1-naphthyl	H	H	H	p-tolyl	H	H
	H-266	2-naphthyl	H	H	H	o-biphenyl	H	H
	H-267	2-naphthyl	H	H	H	m-biphenyl	H	H
	H-268	2-naphthyl	H	H	H	p-biphenyl	H	H
	H-269	2-naphthyl	H	H	H	O-tolyl	H	H
	H-270	2-naphthyl	H	H	H	m-tolyl	H	H
	H-271	2-naphthyl	H	H	H	p-tolyl	H	H
	H-272	o-biphenyl	H	H	H	m-biphenyl	H	H
	H-273	o-biphenyl	H	H	H	p-biphenyl	H	H
	H-274	o-biphenyl	H	H	H	O-tolyl	H	H
	H-275	o-biphenyl	H	H	H	m-tolyl	H	H
	H-276	o-biphenyl	H	H	H	p-tolyl	H	H
	H-277	m-biphenyl	H	H	H	p-biphenyl	H	H
	H-278	m-biphenyl	H	H	H	O-tolyl	H	H
	H-279	m-biphenyl	H	H	H	m-tolyl	H	H
	H-280	m-biphenyl	H	H	H	p-tolyl	H	H
	H-281	p-biphenyl	H	H	H	O-tolyl	H	H
	H-282	p-biphenyl	H	H	H	m-tolyl	H	H
	H-283	p-biphenyl	H	H	H	p-tolyl	H	H
	H-284	O-tolyl	H	H	H	m-tolyl	H	H
	H-285	O-tolyl	H	H	H	p-tolyl	H	H
	H-286	m-tolyl	H	H	H	p-tolyl	H	H

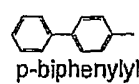
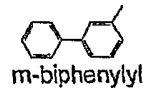
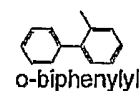
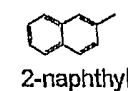
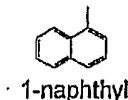
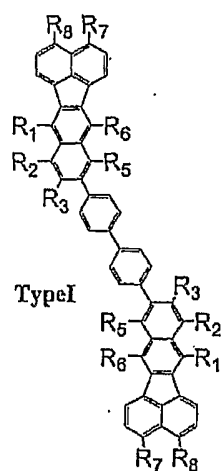

	R ₁	R ₂	R ₃	R ₅	R ₆	R ₇	R ₈
I-1	H	H	H	H	H	H	H
I-2	Ph	H	H	H	Ph	H	H
I-3	Ph	Ph	H	H	Ph	H	H
I-4	Ph	H	H	Ph	Ph	H	H
I-5	Ph	Ph	H	Ph	Ph	H	H
I-6	Ph	H	Ph	H	Ph	H	H
I-7	Ph	H	H	H	Ph	Ph	H
I-8	Ph	H	H	H	Ph	H	Ph
I-9	Ph	H	H	H	Ph	Ph	Ph
I-10	Ph	H	H	H	Ph	1-naphthyl	H
I-11	Ph	H	H	H	Ph	H	1-naphthyl
I-12	Ph	H	H	H	Ph	1-naphthyl	1-naphthyl
I-13	Ph	H	H	H	Ph	2-naphthyl	H
I-14	Ph	H	H	H	Ph	H	2-naphthyl
I-15	Ph	H	H	H	Ph	2-naphthyl	2-naphthyl
I-16	Ph	H	H	H	Ph	o-biphenylyl	H
I-17	Ph	H	H	H	Ph	H	o-biphenylyl
I-18	Ph	H	H	H	Ph	o-biphenylyl	o-biphenylyl
I-19	Ph	H	H	H	Ph	m-biphenylyl	H
I-20	Ph	H	H	H	Ph	H	m-biphenylyl
I-21	Ph	H	H	H	Ph	m-biphenylyl	m-biphenylyl
I-22	Ph	H	H	H	Ph	p-biphenylyl	H
I-23	Ph	H	H	H	Ph	H	p-biphenylyl
I-24	Ph	H	H	H	Ph	p-biphenylyl	p-biphenylyl
I-25	1-naphthyl	H	H	H	1-naphthyl	H	H
I-26	1-naphthyl	Ph	H	H	1-naphthyl	H	H
I-27	1-naphthyl	H	H	Ph	1-naphthyl	H	H
I-28	1-naphthyl	Ph	H	Ph	1-naphthyl	H	H
I-29	1-naphthyl	H	Ph	H	1-naphthyl	H	H
I-30	1-naphthyl	H	H	H	1-naphthyl	Ph	H
I-31	1-naphthyl	H	H	H	1-naphthyl	H	Ph
I-32	1-naphthyl	H	H	H	1-naphthyl	Ph	Ph
I-33	1-naphthyl	H	H	H	1-naphthyl	1-naphthyl	H
I-34	1-naphthyl	H	H	H	1-naphthyl	H	1-naphthyl
I-35	1-naphthyl	H	H	H	1-naphthyl	1-naphthyl	1-naphthyl
I-36	1-naphthyl	H	H	H	1-naphthyl	2-naphthyl	H
I-37	1-naphthyl	H	H	H	1-naphthyl	H	2-naphthyl
I-38	1-naphthyl	H	H	H	1-naphthyl	2-naphthyl	2-naphthyl
I-39	1-naphthyl	H	H	H	1-naphthyl	o-biphenylyl	H
I-40	1-naphthyl	H	H	H	1-naphthyl	H	o-biphenylyl
I-41	1-naphthyl	H	H	H	1-naphthyl	o-biphenylyl	o-biphenylyl
I-42	1-naphthyl	H	H	H	1-naphthyl	m-biphenylyl	H
I-43	1-naphthyl	H	H	H	1-naphthyl	H	m-biphenylyl
I-44	1-naphthyl	H	H	H	1-naphthyl	m-biphenylyl	m-biphenylyl
I-45	1-naphthyl	H	H	H	1-naphthyl	p-biphenylyl	H
I-46	1-naphthyl	H	H	H	1-naphthyl	H	p-biphenylyl
I-47	1-naphthyl	H	H	H	1-naphthyl	p-biphenylyl	p-biphenylyl

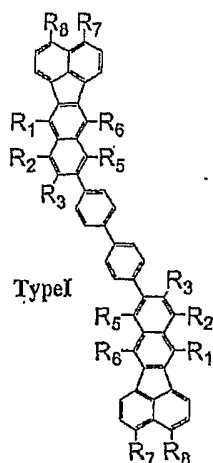

Type I

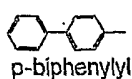
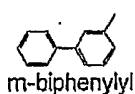
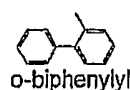
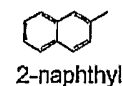
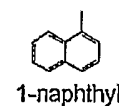

	R ₁	R ₂	R ₃	R ₄	R ₅	R ₆	R ₇	R ₈
I-48	2-naphthyl	H	H	H	2-naphthyl	H	H	
I-49	2-naphthyl	Ph	H	H	2-naphthyl	H	H	
I-50	2-naphthyl	H	H	Ph	2-naphthyl	H	H	
I-51	2-naphthyl	Ph	H	Ph	2-naphthyl	H	H	
I-52	2-naphthyl	H	Ph	H	2-naphthyl	H	H	
I-53	2-naphthyl	H	H	H	2-naphthyl	Ph	H	
I-54	2-naphthyl	H	H	H	2-naphthyl	H	Ph	
I-55	2-naphthyl	H	H	H	2-naphthyl	Ph	Ph	
I-56	2-naphthyl	H	H	H	2-naphthyl	1-naphthyl	H	
I-57	2-naphthyl	H	H	H	2-naphthyl	H	1-naphthyl	
I-58	2-naphthyl	H	H	H	2-naphthyl	1-naphthyl	1-naphthyl	
I-59	2-naphthyl	H	H	H	2-naphthyl	2-naphthyl	H	
I-60	2-naphthyl	H	H	H	2-naphthyl	H	2-naphthyl	
I-61	2-naphthyl	H	H	H	2-naphthyl	2-naphthyl	2-naphthyl	
I-62	2-naphthyl	H	H	H	2-naphthyl	o-biphenyl	H	
I-63	2-naphthyl	H	H	H	2-naphthyl	H	o-biphenyl	
I-64	2-naphthyl	H	H	H	2-naphthyl	o-biphenyl	o-biphenyl	
I-65	2-naphthyl	H	H	H	2-naphthyl	m-biphenyl	H	
I-66	2-naphthyl	H	H	H	2-naphthyl	H	m-biphenyl	
I-67	2-naphthyl	H	H	H	2-naphthyl	m-biphenyl	m-biphenyl	
I-68	2-naphthyl	H	H	H	2-naphthyl	p-biphenyl	H	
I-69	2-naphthyl	H	H	H	2-naphthyl	H	p-biphenyl	
I-70	2-naphthyl	H	H	H	2-naphthyl	p-biphenyl	p-biphenyl	
I-71	o-biphenyl	H	H	H	o-biphenyl	H	H	
I-72	o-biphenyl	Ph	H	H	o-biphenyl	H	H	
I-73	o-biphenyl	H	H	Ph	o-biphenyl	H	H	
I-74	o-biphenyl	Ph	H	Ph	o-biphenyl	H	H	
I-75	o-biphenyl	H	Ph	H	o-biphenyl	H	H	
I-76	o-biphenyl	H	H	H	o-biphenyl	Ph	H	
I-77	o-biphenyl	H	H	H	o-biphenyl	H	Ph	
I-78	o-biphenyl	H	H	H	o-biphenyl	Ph	Ph	
I-79	o-biphenyl	H	H	H	o-biphenyl	1-naphthyl	H	
I-80	o-biphenyl	H	H	H	o-biphenyl	H	1-naphthyl	
I-81	o-biphenyl	H	H	H	o-biphenyl	1-naphthyl	1-naphthyl	
I-82	o-biphenyl	H	H	H	o-biphenyl	2-naphthyl	H	
I-83	o-biphenyl	H	H	H	o-biphenyl	H	2-naphthyl	
I-84	o-biphenyl	H	H	H	o-biphenyl	2-naphthyl	2-naphthyl	
I-85	o-biphenyl	H	H	H	o-biphenyl	o-biphenyl	H	
I-86	o-biphenyl	H	H	H	o-biphenyl	H	o-biphenyl	
I-87	o-biphenyl	H	H	H	o-biphenyl	o-biphenyl	o-biphenyl	
I-88	o-biphenyl	H	H	H	o-biphenyl	m-biphenyl	H	
I-89	o-biphenyl	H	H	H	o-biphenyl	H	m-biphenyl	
I-90	o-biphenyl	H	H	H	o-biphenyl	m-biphenyl	m-biphenyl	
I-91	o-biphenyl	H	H	H	o-biphenyl	p-biphenyl	H	
I-92	o-biphenyl	H	H	H	o-biphenyl	H	p-biphenyl	
I-93	o-biphenyl	H	H	H	o-biphenyl	p-biphenyl	p-biphenyl	

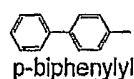
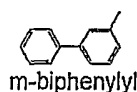
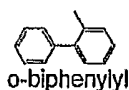
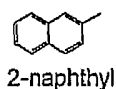
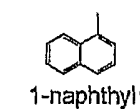
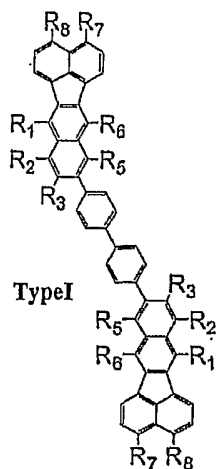

	R ₁	R ₂	R ₃	R ₅	R ₆	R ₇	R ₈
I-94	m-biphenyl	H	H	H	m-biphenyl	H	H
I-95	m-biphenyl	Ph	H	H	m-biphenyl	H	H
I-96	m-biphenyl	H	H	Ph	m-biphenyl	H	H
I-97	m-biphenyl	Ph	H	Ph	m-biphenyl	H	H
I-98	m-biphenyl	H	Ph	H	m-biphenyl	H	H
I-99	m-biphenyl	H	H	H	m-biphenyl	Ph	H
I-100	m-biphenyl	H	H	H	m-biphenyl	H	Ph
I-101	m-biphenyl	H	H	H	m-biphenyl	Ph	Ph
I-102	m-biphenyl	H	H	H	m-biphenyl	1-naphthyl	H
I-103	m-biphenyl	H	H	H	m-biphenyl	H	1-naphthyl
I-104	m-biphenyl	H	H	H	m-biphenyl	1-naphthyl	1-naphthyl
I-105	m-biphenyl	H	H	H	m-biphenyl	2-naphthyl	H
I-106	m-biphenyl	H	H	H	m-biphenyl	H	2-naphthyl
I-107	m-biphenyl	H	H	H	m-biphenyl	2-naphthyl	2-naphthyl
I-108	m-biphenyl	H	H	H	m-biphenyl	o-biphenyl	H
I-109	m-biphenyl	H	H	H	m-biphenyl	H	o-biphenyl
I-110	m-biphenyl	H	H	H	m-biphenyl	o-biphenyl	o-biphenyl
I-111	m-biphenyl	H	H	H	m-biphenyl	m-biphenyl	H
I-112	m-biphenyl	H	H	H	m-biphenyl	H	m-biphenyl
I-113	m-biphenyl	H	H	H	m-biphenyl	m-biphenyl	m-biphenyl
I-114	m-biphenyl	H	H	H	m-biphenyl	p-biphenyl	H
I-115	m-biphenyl	H	H	H	m-biphenyl	H	p-biphenyl
I-116	m-biphenyl	H	H	H	m-biphenyl	p-biphenyl	p-biphenyl
I-117	p-biphenyl	H	H	H	p-biphenyl	H	H
I-118	p-biphenyl	Ph	H	H	p-biphenyl	H	H
I-119	p-biphenyl	H	H	Ph	p-biphenyl	H	H
I-120	p-biphenyl	Ph	H	Ph	p-biphenyl	H	H
I-121	p-biphenyl	H	Ph	H	p-biphenyl	H	H
I-122	p-biphenyl	H	H	H	p-biphenyl	Ph	H
I-123	p-biphenyl	H	H	H	p-biphenyl	H	Ph
I-124	p-biphenyl	H	H	H	p-biphenyl	Ph	Ph
I-125	p-biphenyl	H	H	H	p-biphenyl	1-naphthyl	H
I-126	p-biphenyl	H	H	H	p-biphenyl	H	1-naphthyl
I-127	p-biphenyl	H	H	H	p-biphenyl	1-naphthyl	1-naphthyl
I-128	p-biphenyl	H	H	H	p-biphenyl	2-naphthyl	H
I-129	p-biphenyl	H	H	H	p-biphenyl	H	2-naphthyl
I-130	p-biphenyl	H	H	H	p-biphenyl	2-naphthyl	2-naphthyl
I-131	p-biphenyl	H	H	H	p-biphenyl	o-biphenyl	H
I-132	p-biphenyl	H	H	H	p-biphenyl	H	o-biphenyl
I-133	p-biphenyl	H	H	H	p-biphenyl	o-biphenyl	o-biphenyl
I-134	p-biphenyl	H	H	H	p-biphenyl	m-biphenyl	H
I-135	p-biphenyl	H	H	H	p-biphenyl	H	m-biphenyl
I-136	p-biphenyl	H	H	H	p-biphenyl	m-biphenyl	m-biphenyl
I-137	p-biphenyl	H	H	H	p-biphenyl	p-biphenyl	H
I-138	p-biphenyl	H	H	H	p-biphenyl	H	p-biphenyl
I-139	p-biphenyl	H	H	H	p-biphenyl	p-biphenyl	p-biphenyl

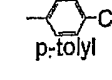
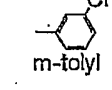
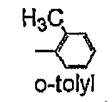
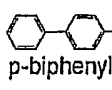
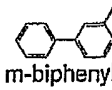
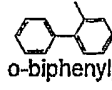
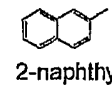
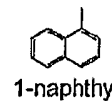
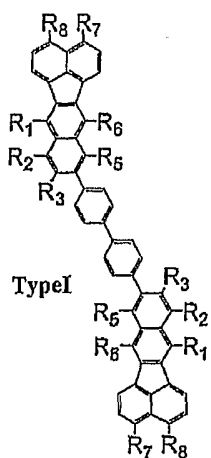

	R ₁	R ₂	R ₃	R ₅	R ₆	R ₇	R ₈
I-140	o-tolyl	H	H	H	o-tolyl	H	H
I-141	o-tolyl	Ph	H	Ph	o-tolyl	H	H
I-142	o-tolyl	H	Ph	H	o-tolyl	H	H
I-143	o-tolyl	H	H	H	o-tolyl	Ph	H
I-144	o-tolyl	H	H	H	o-tolyl	H	Ph
I-145	o-tolyl	H	H	H	o-tolyl	1-naphthyl	H
I-146	o-tolyl	H	H	H	o-tolyl	H	1-naphthyl
I-147	o-tolyl	H	H	H	o-tolyl	2-naphthyl	H
I-148	o-tolyl	H	H	H	o-tolyl	H	2-naphthyl
I-149	o-tolyl	H	H	H	o-tolyl	o-biphenylyl	H
I-150	o-tolyl	H	H	H	o-tolyl	H	o-biphenylyl
I-151	o-tolyl	H	H	H	o-tolyl	m-biphenylyl	H
I-152	o-tolyl	H	H	H	o-tolyl	H	m-biphenylyl
I-153	o-tolyl	H	H	H	o-tolyl	p-biphenylyl	H
I-154	o-tolyl	H	H	H	o-tolyl	H	p-biphenylyl
I-155	o-tolyl	H	H	H	o-tolyl	o-tolyl	H
I-156	o-tolyl	H	H	H	o-tolyl	H	o-tolyl
I-157	m-tolyl	H	H	H	m-tolyl	H	H
I-158	m-tolyl	Ph	H	Ph	m-tolyl	H	H
I-159	m-tolyl	H	Ph	H	m-tolyl	H	H
I-160	m-tolyl	H	H	H	m-tolyl	Ph	H
I-161	m-tolyl	H	H	H	m-tolyl	H	Ph
I-162	m-tolyl	H	H	H	m-tolyl	1-naphthyl	H
I-163	m-tolyl	H	H	H	m-tolyl	H	1-naphthyl
I-164	m-tolyl	H	H	H	m-tolyl	2-naphthyl	H
I-165	m-tolyl	H	H	H	m-tolyl	H	2-naphthyl
I-166	m-tolyl	H	H	H	m-tolyl	o-biphenylyl	H
I-167	m-tolyl	H	H	H	m-tolyl	H	o-biphenylyl
I-168	m-tolyl	H	H	H	m-tolyl	m-biphenylyl	H
I-169	m-tolyl	H	H	H	m-tolyl	H	m-biphenylyl
I-170	m-tolyl	H	H	H	m-tolyl	p-biphenylyl	H
I-171	m-tolyl	H	H	H	m-tolyl	H	p-biphenylyl
I-172	m-tolyl	H	H	H	m-tolyl	m-tolyl	H
I-173	m-tolyl	H	H	H	m-tolyl	H	m-tolyl
I-174	p-tolyl	H	H	H	p-tolyl	H	H
I-175	p-tolyl	Ph	H	Ph	p-tolyl	H	H
I-176	p-tolyl	H	Ph	H	p-tolyl	H	H
I-177	p-tolyl	H	H	H	p-tolyl	Ph	H
I-178	p-tolyl	H	H	H	p-tolyl	H	Ph
I-179	p-tolyl	H	H	H	p-tolyl	1-naphthyl	H
I-180	p-tolyl	H	H	H	p-tolyl	H	1-naphthyl
I-181	p-tolyl	H	H	H	p-tolyl	2-naphthyl	H
I-182	p-tolyl	H	H	H	p-tolyl	H	2-naphthyl
I-183	p-tolyl	H	H	H	p-tolyl	o-biphenylyl	H
I-184	p-tolyl	H	H	H	p-tolyl	H	o-biphenylyl
I-185	p-tolyl	H	H	H	p-tolyl	m-biphenylyl	H
I-186	p-tolyl	H	H	H	p-tolyl	H	m-biphenylyl
I-187	p-tolyl	H	H	H	p-tolyl	p-biphenylyl	H
I-188	p-tolyl	H	H	H	p-tolyl	H	p-biphenylyl
I-189	p-tolyl	H	H	H	p-tolyl	p-tolyl	H
I-190	p-tolyl	H	H	H	p-tolyl	H	p-tolyl

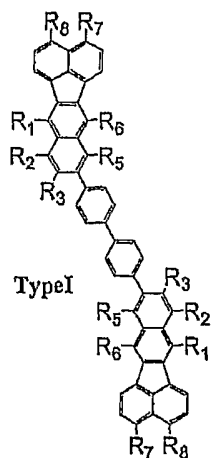

	R ₁	R ₂	R ₃	R ₅	R ₆	R ₇	R ₈
I-191	Ph	H	-CH ₃	H	Ph	H	H
I-192	1-naphthyl	H	-CH ₃	H	1-naphthyl	H	H
I-193	2-naphthyl	H	-CH ₃	H	2-naphthyl	H	H
I-194	o-biphenyl	H	-CH ₃	H	o-biphenyl	H	H
I-195	m-biphenyl	H	-CH ₃	H	m-biphenyl	H	H
I-196	p-biphenyl	H	-CH ₃	H	p-biphenyl	H	H
I-197	o-tolyl	H	-CH ₃	H	o-tolyl	H	H
I-198	m-tolyl	H	-CH ₃	H	m-tolyl	H	H
I-199	p-tolyl	H	-CH ₃	H	p-tolyl	H	H
I-200	Ph	H	H	H	Ph	-CH ₃	H
I-201	1-naphthyl	H	H	H	1-naphthyl	-CH ₃	H
I-202	2-naphthyl	H	H	H	2-naphthyl	-CH ₃	H
I-203	o-biphenyl	H	H	H	o-biphenyl	-CH ₃	H
I-204	m-biphenyl	H	H	H	m-biphenyl	-CH ₃	H
I-205	p-biphenyl	H	H	H	p-biphenyl	-CH ₃	H
I-206	o-tolyl	H	H	H	o-tolyl	-CH ₃	H
I-207	m-tolyl	H	H	H	m-tolyl	-CH ₃	H
I-208	p-tolyl	H	H	H	p-tolyl	-CH ₃	H
I-209	Ph	H	H	H	Ph	H	-CH ₃
I-210	1-naphthyl	H	H	H	1-naphthyl	H	-CH ₃
I-211	2-naphthyl	H	H	H	2-naphthyl	H	-CH ₃
I-212	o-biphenyl	H	H	H	o-biphenyl	H	-CH ₃
I-213	m-biphenyl	H	H	H	m-biphenyl	H	-CH ₃
I-214	p-biphenyl	H	H	H	p-biphenyl	H	-CH ₃
I-215	o-tolyl	H	H	H	o-tolyl	H	-CH ₃
I-216	m-tolyl	H	H	H	m-tolyl	H	-CH ₃
I-217	p-tolyl	H	H	H	p-tolyl	H	-CH ₃
I-218	Ph	H	H	H	Ph	-CH ₃	-CH ₃
I-219	1-naphthyl	H	H	H	1-naphthyl	-CH ₃	-CH ₃
I-220	2-naphthyl	H	H	H	2-naphthyl	-CH ₃	-CH ₃
I-221	o-biphenyl	H	H	H	o-biphenyl	-CH ₃	-CH ₃
I-222	m-biphenyl	H	H	H	m-biphenyl	-CH ₃	-CH ₃
I-223	p-biphenyl	H	H	H	p-biphenyl	-CH ₃	-CH ₃
I-224	o-tolyl	H	H	H	o-tolyl	-CH ₃	-CH ₃
I-225	m-tolyl	H	H	H	m-tolyl	-CH ₃	-CH ₃
I-226	p-tolyl	H	H	H	p-tolyl	-CH ₃	-CH ₃
I-227	Ph	H	H	H	Ph	H	DPA
I-228	1-naphthyl	H	H	H	1-naphthyl	H	DPA
I-229	2-naphthyl	H	H	H	2-naphthyl	H	DPA
I-230	o-biphenyl	H	H	H	o-biphenyl	H	DPA
I-231	m-biphenyl	H	H	H	m-biphenyl	H	DPA
I-232	p-biphenyl	H	H	H	p-biphenyl	H	DPA
I-233	Ph	H	H	H	Ph	DPA	H
I-234	1-naphthyl	H	H	H	1-naphthyl	DPA	H
I-235	2-naphthyl	H	H	H	2-naphthyl	DPA	H
I-236	o-biphenyl	H	H	H	o-biphenyl	DPA	H
I-237	m-biphenyl	H	H	H	m-biphenyl	DPA	H
I-238	p-biphenyl	H	H	H	p-biphenyl	DPA	H
I-239	Ph	H	H	H	Ph	H	TPA
I-240	1-naphthyl	H	H	H	1-naphthyl	H	TPA
I-241	2-naphthyl	H	H	H	2-naphthyl	H	TPA
I-242	o-biphenyl	H	H	H	o-biphenyl	H	TPA
I-243	m-biphenyl	H	H	H	m-biphenyl	H	TPA
I-244	p-biphenyl	H	H	H	p-biphenyl	H	TPA
I-245	Ph	H	H	H	Ph	TPA	H
I-246	1-naphthyl	H	H	H	1-naphthyl	TPA	H
I-247	2-naphthyl	H	H	H	2-naphthyl	TPA	H
I-248	o-biphenyl	H	H	H	o-biphenyl	TPA	H
I-249	m-biphenyl	H	H	H	m-biphenyl	TPA	H
I-250	p-biphenyl	H	H	H	p-biphenyl	TPA	H

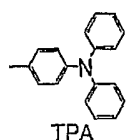
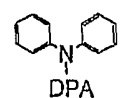
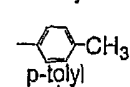
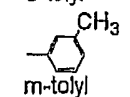
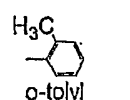
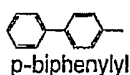
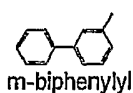
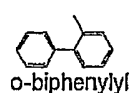
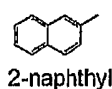
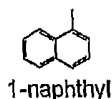

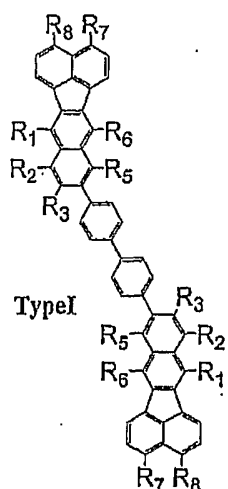

	R ₁	R ₂	R ₃	R ₅	R ₆	R ₇	R ₈
I-251	Ph	H	H	H	1-naphthyl	H	H
I-252	Ph	H	H	H	2-naphthyl	H	H
I-253	Ph	H	H	H	o-biphenyl	H	H
I-254	Ph	H	H	H	m-biphenyl	H	H
I-255	Ph	H	H	H	p-biphenyl	H	H
I-256	Ph	H	H	H	O-tolyl	H	H
I-257	Ph	H	H	H	m-tolyl	H	H
I-258	Ph	H	H	H	p-tolyl	H	H
I-259	1-naphthyl	H	H	H	2-naphthyl	H	H
I-260	1-naphthyl	H	H	H	o-biphenyl	H	H
I-261	1-naphthyl	H	H	H	m-biphenyl	H	H
I-262	1-naphthyl	H	H	H	p-biphenyl	H	H
I-263	1-naphthyl	H	H	H	O-tolyl	H	H
I-264	1-naphthyl	H	H	H	m-tolyl	H	H
I-265	1-naphthyl	H	H	H	p-tolyl	H	H
I-266	2-naphthyl	H	H	H	o-biphenyl	H	H
I-267	2-naphthyl	H	H	H	m-biphenyl	H	H
I-268	2-naphthyl	H	H	H	p-biphenyl	H	H
I-269	2-naphthyl	H	H	H	O-tolyl	H	H
I-270	2-naphthyl	H	H	H	m-tolyl	H	H
I-271	2-naphthyl	H	H	H	p-tolyl	H	H
I-272	o-biphenyl	H	H	H	m-biphenyl	H	H
I-273	o-biphenyl	H	H	H	p-biphenyl	H	H
I-274	o-biphenyl	H	H	H	O-tolyl	H	H
I-275	o-biphenyl	H	H	H	m-tolyl	H	H
I-276	o-biphenyl	H	H	H	p-tolyl	H	H
I-277	m-biphenyl	H	H	H	p-biphenyl	H	H
I-278	m-biphenyl	H	H	H	O-tolyl	H	H
I-279	m-biphenyl	H	H	H	m-tolyl	H	H
I-280	m-biphenyl	H	H	H	p-tolyl	H	H
I-281	p-biphenyl	H	H	H	O-tolyl	H	H
I-282	p-biphenyl	H	H	H	m-tolyl	H	H
I-283	p-biphenyl	H	H	H	p-tolyl	H	H
I-284	O-tolyl	H	H	H	m-tolyl	H	H
I-285	O-tolyl	H	H	H	p-tolyl	H	H
I-286	m-tolyl	H	H	H	p-tolyl	H	H

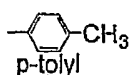
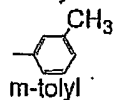
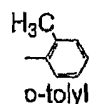
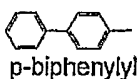
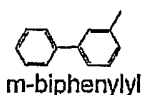
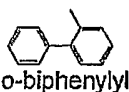
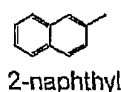
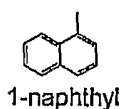

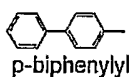
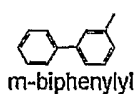
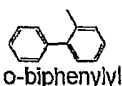
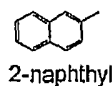
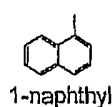
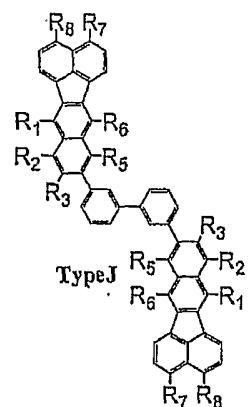

	R ₁	R ₂	R ₃	R ₅	R ₆	R ₇	R ₈
J-1	H	H	H	H	H	H	H
J-2	Ph	H	H	H	Ph	H	H
J-3	Ph	Ph	H	H	Ph	H	H
J-4	Ph	H	H	Ph	Ph	H	H
J-5	Ph	Ph	H	Ph	Ph	H	H
J-6	Ph	H	Ph	H	Ph	H	H
J-7	Ph	H	H	H	Ph	Ph	H
J-8	Ph	H	H	H	Ph	H	Ph
J-9	Ph	H	H	H	Ph	Ph	Ph
J-10	Ph	H	H	H	Ph	1-naphthyl	H
J-11	Ph	H	H	H	Ph	H	1-naphthyl
J-12	Ph	H	H	H	Ph	1-naphthyl	1-naphthyl
J-13	Ph	H	H	H	Ph	2-naphthyl	H
J-14	Ph	H	H	H	Ph	H	2-naphthyl
J-15	Ph	H	H	H	Ph	2-naphthyl	2-naphthyl
J-16	Ph	H	H	H	Ph	o-biphenyl	H
J-17	Ph	H	H	H	Ph	H	o-biphenyl
J-18	Ph	H	H	H	Ph	o-biphenyl	o-biphenyl
J-19	Ph	H	H	H	Ph	m-biphenyl	H
J-20	Ph	H	H	H	Ph	H	m-biphenyl
J-21	Ph	H	H	H	Ph	m-biphenyl	m-biphenyl
J-22	Ph	H	H	H	Ph	p-biphenyl	H
J-23	Ph	H	H	H	Ph	H	p-biphenyl
J-24	Ph	H	H	H	Ph	p-biphenyl	p-biphenyl
J-25	1-naphthyl	H	H	H	1-naphthyl	H	H
J-26	1-naphthyl	Ph	H	H	1-naphthyl	H	H
J-27	1-naphthyl	H	H	Ph	1-naphthyl	H	H
J-28	1-naphthyl	Ph	H	Ph	1-naphthyl	H	H
J-29	1-naphthyl	H	Ph	H	1-naphthyl	H	H
J-30	1-naphthyl	H	H	H	1-naphthyl	Ph	H
J-31	1-naphthyl	H	H	H	1-naphthyl	H	Ph
J-32	1-naphthyl	H	H	H	1-naphthyl	Ph	Ph
J-33	1-naphthyl	H	H	H	1-naphthyl	1-naphthyl	H
J-34	1-naphthyl	H	H	H	1-naphthyl	H	1-naphthyl
J-35	1-naphthyl	H	H	H	1-naphthyl	1-naphthyl	1-naphthyl
J-36	1-naphthyl	H	H	H	1-naphthyl	2-naphthyl	H
J-37	1-naphthyl	H	H	H	1-naphthyl	H	2-naphthyl
J-38	1-naphthyl	H	H	H	1-naphthyl	2-naphthyl	2-naphthyl
J-39	1-naphthyl	H	H	H	1-naphthyl	o-biphenyl	H
J-40	1-naphthyl	H	H	H	1-naphthyl	H	o-biphenyl
J-41	1-naphthyl	H	H	H	1-naphthyl	o-biphenyl	o-biphenyl
J-42	1-naphthyl	H	H	H	1-naphthyl	m-biphenyl	H
J-43	1-naphthyl	H	H	H	1-naphthyl	H	m-biphenyl
J-44	1-naphthyl	H	H	H	1-naphthyl	m-biphenyl	m-biphenyl
J-45	1-naphthyl	H	H	H	1-naphthyl	p-biphenyl	H
J-46	1-naphthyl	H	H	H	1-naphthyl	H	p-biphenyl
J-47	1-naphthyl	H	H	H	1-naphthyl	p-biphenyl	p-biphenyl

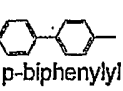
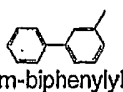
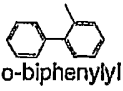
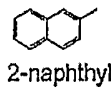
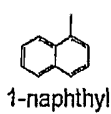
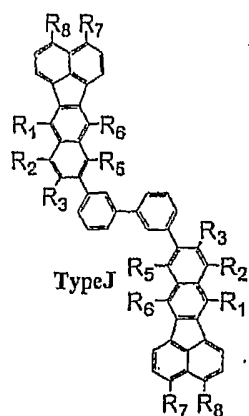

	R ₁	R ₂	R ₃	R ₅	R ₆	R ₇	R ₈
J-48	2-naphthyl	H	H	H	2-naphthyl	H	H
J-49	2-naphthyl	Ph	H	H	2-naphthyl	H	H
J-50	2-naphthyl	H	H	Ph	2-naphthyl	H	H
J-51	2-naphthyl	Ph	H	Ph	2-naphthyl	H	H
J-52	2-naphthyl	H	Ph	H	2-naphthyl	H	H
J-53	2-naphthyl	H	H	H	2-naphthyl	Ph	H
J-54	2-naphthyl	H	H	H	2-naphthyl	H	Ph
J-55	2-naphthyl	H	H	H	2-naphthyl	Ph	Ph
J-56	2-naphthyl	H	H	H	2-naphthyl	1-naphthyl	H
J-57	2-naphthyl	H	H	H	2-naphthyl	H	1-naphthyl
J-58	2-naphthyl	H	H	H	2-naphthyl	1-naphthyl	1-naphthyl
J-59	2-naphthyl	H	H	H	2-naphthyl	2-naphthyl	H
J-60	2-naphthyl	H	H	H	2-naphthyl	H	2-naphthyl
J-61	2-naphthyl	H	H	H	2-naphthyl	2-naphthyl	2-naphthyl
J-62	2-naphthyl	H	H	H	2-naphthyl	o-biphenyl	H
J-63	2-naphthyl	H	H	H	2-naphthyl	H	o-biphenyl
J-64	2-naphthyl	H	H	H	2-naphthyl	o-biphenyl	o-biphenyl
J-65	2-naphthyl	H	H	H	2-naphthyl	m-biphenyl	H
J-66	2-naphthyl	H	H	H	2-naphthyl	H	m-biphenyl
J-67	2-naphthyl	H	H	H	2-naphthyl	m-biphenyl	m-biphenyl
J-68	2-naphthyl	H	H	H	2-naphthyl	p-biphenyl	H
J-69	2-naphthyl	H	H	H	2-naphthyl	H	p-biphenyl
J-70	2-naphthyl	H	H	H	2-naphthyl	p-biphenyl	p-biphenyl
J-71	o-biphenyl	H	H	H	o-biphenyl	H	H
J-72	o-biphenyl	Ph	H	H	o-biphenyl	H	H
J-73	o-biphenyl	H	H	Ph	o-biphenyl	H	H
J-74	o-biphenyl	Ph	H	Ph	o-biphenyl	H	H
J-75	o-biphenyl	H	Ph	H	o-biphenyl	H	H
J-76	o-biphenyl	H	H	H	o-biphenyl	Ph	H
J-77	o-biphenyl	H	H	H	o-biphenyl	H	Ph
J-78	o-biphenyl	H	H	H	o-biphenyl	Ph	Ph
J-79	o-biphenyl	H	H	H	o-biphenyl	1-naphthyl	H
J-80	o-biphenyl	H	H	H	o-biphenyl	H	1-naphthyl
J-81	o-biphenyl	H	H	H	o-biphenyl	1-naphthyl	1-naphthyl
J-82	o-biphenyl	H	H	H	o-biphenyl	2-naphthyl	H
J-83	o-biphenyl	H	H	H	o-biphenyl	H	2-naphthyl
J-84	o-biphenyl	H	H	H	o-biphenyl	2-naphthyl	2-naphthyl
J-85	o-biphenyl	H	H	H	o-biphenyl	o-biphenyl	H
J-86	o-biphenyl	H	H	H	o-biphenyl	H	o-biphenyl
J-87	o-biphenyl	H	H	H	o-biphenyl	o-biphenyl	o-biphenyl
J-88	o-biphenyl	H	H	H	o-biphenyl	m-biphenyl	H
J-89	o-biphenyl	H	H	H	o-biphenyl	H	m-biphenyl
J-90	o-biphenyl	H	H	H	o-biphenyl	m-biphenyl	m-biphenyl
J-91	o-biphenyl	H	H	H	o-biphenyl	p-biphenyl	H
J-92	o-biphenyl	H	H	H	o-biphenyl	H	p-biphenyl
J-93	o-biphenyl	H	H	H	o-biphenyl	p-biphenyl	p-biphenyl

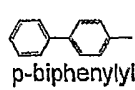
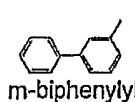
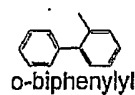
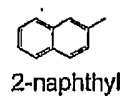
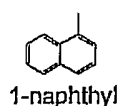
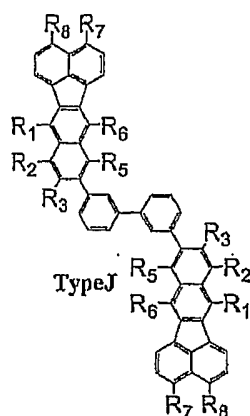

	R ₁	R ₂	R ₃	R ₅	R ₆	R ₇	R ₈
J-94	m-biphenyl	H	H	H	m-biphenyl	H	H
J-95	m-biphenyl	Ph	H	H	m-biphenyl	H	H
J-96	m-biphenyl	H	H	Ph	m-biphenyl	H	H
J-97	m-biphenyl	Ph	H	Ph	m-biphenyl	H	H
J-98	m-biphenyl	H	Ph	H	m-biphenyl	H	H
J-99	m-biphenyl	H	H	H	m-biphenyl	Ph	H
J-100	m-biphenyl	H	H	H	m-biphenyl	H	Ph
J-101	m-biphenyl	H	H	H	m-biphenyl	Ph	Ph
J-102	m-biphenyl	H	H	H	m-biphenyl	1-naphthyl	H
J-103	m-biphenyl	H	H	H	m-biphenyl	H	1-naphthyl
J-104	m-biphenyl	H	H	H	m-biphenyl	1-naphthyl	1-naphthyl
J-105	m-biphenyl	H	H	H	m-biphenyl	2-naphthyl	H
J-106	m-biphenyl	H	H	H	m-biphenyl	H	2-naphthyl
J-107	m-biphenyl	H	H	H	m-biphenyl	2-naphthyl	2-naphthyl
J-108	m-biphenyl	H	H	H	m-biphenyl	o-biphenyl	H
J-109	m-biphenyl	H	H	H	m-biphenyl	H	o-biphenyl
J-110	m-biphenyl	H	H	H	m-biphenyl	o-biphenyl	o-biphenyl
J-111	m-biphenyl	H	H	H	m-biphenyl	m-biphenyl	H
J-112	m-biphenyl	H	H	H	m-biphenyl	H	m-biphenyl
J-113	m-biphenyl	H	H	H	m-biphenyl	m-biphenyl	m-biphenyl
J-114	m-biphenyl	H	H	H	m-biphenyl	p-biphenyl	H
J-115	m-biphenyl	H	H	H	m-biphenyl	H	p-biphenyl
J-116	m-biphenyl	H	H	H	m-biphenyl	p-biphenyl	p-biphenyl
J-117	p-biphenyl	H	H	H	p-biphenyl	H	H
J-118	p-biphenyl	Ph	H	H	p-biphenyl	H	H
J-119	p-biphenyl	H	H	Ph	p-biphenyl	H	H
J-120	p-biphenyl	Ph	H	Ph	p-biphenyl	H	H
J-121	p-biphenyl	H	Ph	H	p-biphenyl	H	H
J-122	p-biphenyl	H	H	H	p-biphenyl	Ph	H
J-123	p-biphenyl	H	H	H	p-biphenyl	H	Ph
J-124	p-biphenyl	H	H	H	p-biphenyl	Ph	Ph
J-125	p-biphenyl	H	H	H	p-biphenyl	1-naphthyl	H
J-126	p-biphenyl	H	H	H	p-biphenyl	H	1-naphthyl
J-127	p-biphenyl	H	H	H	p-biphenyl	1-naphthyl	1-naphthyl
J-128	p-biphenyl	H	H	H	p-biphenyl	2-naphthyl	H
J-129	p-biphenyl	H	H	H	p-biphenyl	H	2-naphthyl
J-130	p-biphenyl	H	H	H	p-biphenyl	2-naphthyl	2-naphthyl
J-131	p-biphenyl	H	H	H	p-biphenyl	o-biphenyl	H
J-132	p-biphenyl	H	H	H	p-biphenyl	H	o-biphenyl
J-133	p-biphenyl	H	H	H	p-biphenyl	o-biphenyl	o-biphenyl
J-134	p-biphenyl	H	H	H	p-biphenyl	m-biphenyl	H
J-135	p-biphenyl	H	H	H	p-biphenyl	H	m-biphenyl
J-136	p-biphenyl	H	H	H	p-biphenyl	m-biphenyl	m-biphenyl
J-137	p-biphenyl	H	H	H	p-biphenyl	p-biphenyl	H
J-138	p-biphenyl	H	H	H	p-biphenyl	H	p-biphenyl
J-139	p-biphenyl	H	H	H	p-biphenyl	p-biphenyl	p-biphenyl

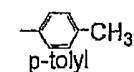
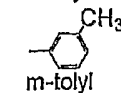
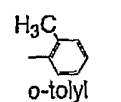
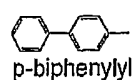
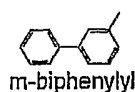
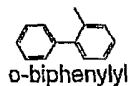
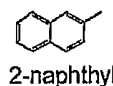
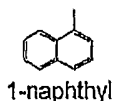
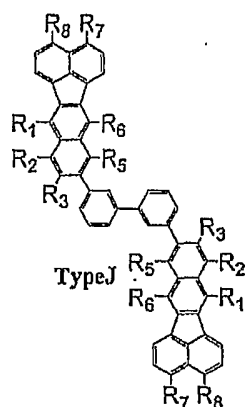

	R ₁	R ₂	R ₃	R ₅	R ₆	R ₇	R ₈
J-140	o-tolyl	H	H	H	o-tolyl	H	H
J-141	o-tolyl	Ph	H	Ph	o-tolyl	H	H
J-142	o-tolyl	H	Ph	H	o-tolyl	H	H
J-143	o-tolyl	H	H	H	o-tolyl	Ph	H
J-144	o-tolyl	H	H	H	o-tolyl	H	Ph
J-145	o-tolyl	H	H	H	o-tolyl	1-naphthyl	H
J-146	o-tolyl	H	H	H	o-tolyl	H	1-naphthyl
J-147	o-tolyl	H	H	H	o-tolyl	2-naphthyl	H
J-148	o-tolyl	H	H	H	o-tolyl	H	2-naphthyl
J-149	o-tolyl	H	H	H	o-tolyl	o-biphenyl	H
J-150	o-tolyl	H	H	H	o-tolyl	H	o-biphenyl
J-151	o-tolyl	H	H	H	o-tolyl	m-biphenyl	H
J-152	o-tolyl	H	H	H	o-tolyl	H	m-biphenyl
J-153	o-tolyl	H	H	H	o-tolyl	p-biphenyl	H
J-154	o-tolyl	H	H	H	o-tolyl	H	p-biphenyl
J-155	o-tolyl	H	H	H	o-tolyl	o-tolyl	H
J-156	o-tolyl	H	H	H	o-tolyl	H	o-tolyl
J-157	m-tolyl	H	H	H	m-tolyl	H	H
J-158	m-tolyl	Ph	H	Ph	m-tolyl	H	H
J-159	m-tolyl	H	Ph	H	m-tolyl	H	H
J-160	m-tolyl	H	H	H	m-tolyl	Ph	H
J-161	m-tolyl	H	H	H	m-tolyl	H	Ph
J-162	m-tolyl	H	H	H	m-tolyl	1-naphthyl	H
J-163	m-tolyl	H	H	H	m-tolyl	H	1-naphthyl
J-164	m-tolyl	H	H	H	m-tolyl	2-naphthyl	H
J-165	m-tolyl	H	H	H	m-tolyl	H	2-naphthyl
J-166	m-tolyl	H	H	H	m-tolyl	o-biphenyl	H
J-167	m-tolyl	H	H	H	m-tolyl	H	o-biphenyl
J-168	m-tolyl	H	H	H	m-tolyl	m-biphenyl	H
J-169	m-tolyl	H	H	H	m-tolyl	H	m-biphenyl
J-170	m-tolyl	H	H	H	m-tolyl	p-biphenyl	H
J-171	m-tolyl	H	H	H	m-tolyl	H	p-biphenyl
J-172	m-tolyl	H	H	H	m-tolyl	m-tolyl	H
J-173	m-tolyl	H	H	H	m-tolyl	H	m-tolyl
J-174	p-tolyl	H	H	H	p-tolyl	H	H
J-175	p-tolyl	Ph	H	Ph	p-tolyl	H	H
J-176	p-tolyl	H	Ph	H	p-tolyl	H	H
J-177	p-tolyl	H	H	H	p-tolyl	Ph	H
J-178	p-tolyl	H	H	H	p-tolyl	H	Ph
J-179	p-tolyl	H	H	H	p-tolyl	1-naphthyl	H
J-180	p-tolyl	H	H	H	p-tolyl	H	1-naphthyl
J-181	p-tolyl	H	H	H	p-tolyl	2-naphthyl	H
J-182	p-tolyl	H	H	H	p-tolyl	H	2-naphthyl
J-183	p-tolyl	H	H	H	p-tolyl	o-biphenyl	H
J-184	p-tolyl	H	H	H	p-tolyl	H	o-biphenyl
J-185	p-tolyl	H	H	H	p-tolyl	m-biphenyl	H
J-186	p-tolyl	H	H	H	p-tolyl	H	m-biphenyl
J-187	p-tolyl	H	H	H	p-tolyl	p-biphenyl	H
J-188	p-tolyl	H	H	H	p-tolyl	H	p-biphenyl
J-189	p-tolyl	H	H	H	p-tolyl	p-tolyl	H
J-190	p-tolyl	H	H	H	p-tolyl	H	p-tolyl

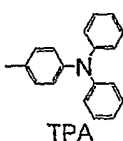
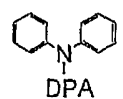
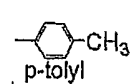
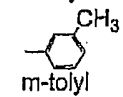
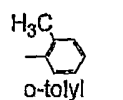
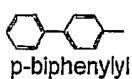
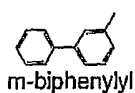
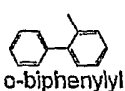
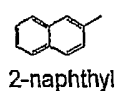
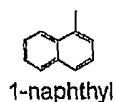
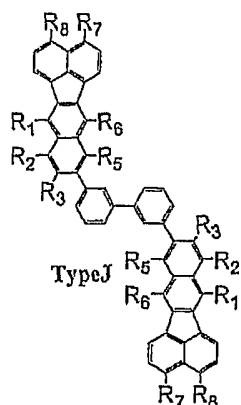

	R ₁	R ₂	R ₃	R ₅	R ₆	R ₇	R ₈
J-191	Ph	H	-CH3	H	Ph	H	H
J-192	1-naphthyl	H	-CH3	H	1-naphthyl	H	H
J-193	2-naphthyl	H	-CH3	H	2-naphthyl	H	H
J-194	o-biphenyl	H	-CH3	H	o-biphenyl	H	H
J-195	m-biphenyl	H	-CH3	H	m-biphenyl	H	H
J-196	p-biphenyl	H	-CH3	H	p-biphenyl	H	H
J-197	o-tolyl	H	-CH3	H	o-tolyl	H	H
J-198	m-tolyl	H	-CH3	H	m-tolyl	H	H
J-199	p-tolyl	H	-CH3	H	p-tolyl	H	H
J-200	Ph	H	H	H	Ph	-CH3	H
J-201	1-naphthyl	H	H	H	1-naphthyl	-CH3	H
J-202	2-naphthyl	H	H	H	2-naphthyl	-CH3	H
J-203	o-biphenyl	H	H	H	o-biphenyl	-CH3	H
J-204	m-biphenyl	H	H	H	m-biphenyl	-CH3	H
J-205	p-biphenyl	H	H	H	p-biphenyl	-CH3	H
J-206	o-tolyl	H	H	H	o-tolyl	-CH3	H
J-207	m-tolyl	H	H	H	m-tolyl	-CH3	H
J-208	p-tolyl	H	H	H	p-tolyl	-CH3	H
J-209	Ph	H	H	H	Ph	H	-CH3
J-210	1-naphthyl	H	H	H	1-naphthyl	H	-CH3
J-211	2-naphthyl	H	H	H	2-naphthyl	H	-CH3
J-212	o-biphenyl	H	H	H	o-biphenyl	H	-CH3
J-213	m-biphenyl	H	H	H	m-biphenyl	H	-CH3
J-214	p-biphenyl	H	H	H	p-biphenyl	H	-CH3
J-215	o-tolyl	H	H	H	o-tolyl	H	-CH3
J-216	m-tolyl	H	H	H	m-tolyl	H	-CH3
J-217	p-tolyl	H	H	H	p-tolyl	H	-CH3
J-218	Ph	H	H	H	Ph	-CH3	-CH3
J-219	1-naphthyl	H	H	H	1-naphthyl	-CH3	-CH3
J-220	2-naphthyl	H	H	H	2-naphthyl	-CH3	-CH3
J-221	o-biphenyl	H	H	H	o-biphenyl	-CH3	-CH3
J-222	m-biphenyl	H	H	H	m-biphenyl	-CH3	-CH3
J-223	p-biphenyl	H	H	H	p-biphenyl	-CH3	-CH3
J-224	o-tolyl	H	H	H	o-tolyl	-CH3	-CH3
J-225	m-tolyl	H	H	H	m-tolyl	-CH3	-CH3
J-226	p-tolyl	H	H	H	p-tolyl	-CH3	-CH3
J-227	Ph	H	H	H	Ph	H	DPA
J-228	1-naphthyl	H	H	H	1-naphthyl	H	DPA
J-229	2-naphthyl	H	H	H	2-naphthyl	H	DPA
J-230	o-biphenyl	H	H	H	o-biphenyl	H	DPA
J-231	m-biphenyl	H	H	H	m-biphenyl	H	DPA
J-232	p-biphenyl	H	H	H	p-biphenyl	H	DPA
J-233	Ph	H	H	H	Ph	DPA	H
J-234	1-naphthyl	H	H	H	1-naphthyl	DPA	H
J-235	2-naphthyl	H	H	H	2-naphthyl	DPA	H
J-236	o-biphenyl	H	H	H	o-biphenyl	DPA	H
J-237	m-biphenyl	H	H	H	m-biphenyl	DPA	H
J-238	p-biphenyl	H	H	H	p-biphenyl	DPA	H
J-239	Ph	H	H	H	Ph	H	TPA
J-240	1-naphthyl	H	H	H	1-naphthyl	H	TPA
J-241	2-naphthyl	H	H	H	2-naphthyl	H	TPA
J-242	o-biphenyl	H	H	H	o-biphenyl	H	TPA
J-243	m-biphenyl	H	H	H	m-biphenyl	H	TPA
J-244	p-biphenyl	H	H	H	p-biphenyl	H	TPA
J-245	Ph	H	H	H	Ph	TPA	H
J-246	1-naphthyl	H	H	H	1-naphthyl	TPA	H
J-247	2-naphthyl	H	H	H	2-naphthyl	TPA	H
J-248	o-biphenyl	H	H	H	o-biphenyl	TPA	H
J-249	m-biphenyl	H	H	H	m-biphenyl	TPA	H
J-250	p-biphenyl	H	H	H	p-biphenyl	TPA	H

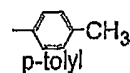
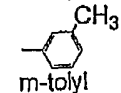
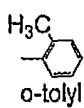
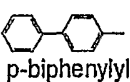
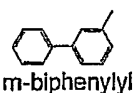
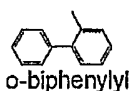
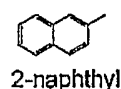
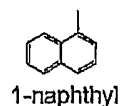
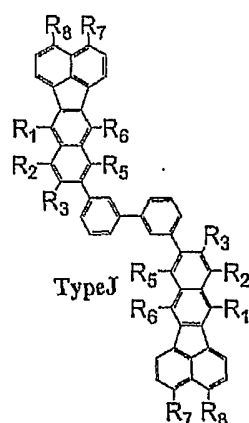



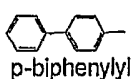
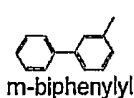
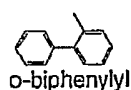
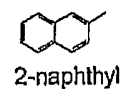
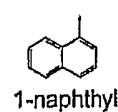
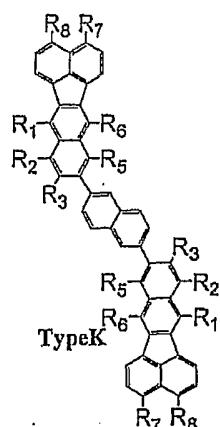

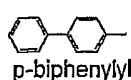
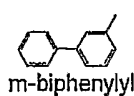
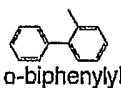
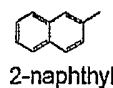
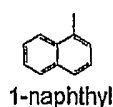
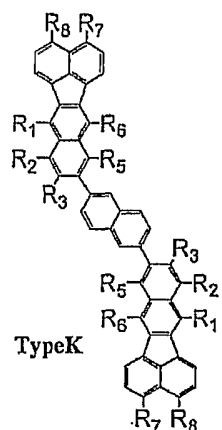

	R ₁	R ₂	R ₃	R ₅	R ₆	R ₇	R ₈
J-251	Ph	H	H	H	1-naphthyl	H	H
J-252	Ph	H	H	H	2-naphthyl	H	H
J-253	Ph	H	H	H	o-biphenyl	H	H
J-254	Ph	H	H	H	m-biphenyl	H	H
J-255	Ph	H	H	H	p-biphenyl	H	H
J-256	Ph	H	H	H	O-tolyl	H	H
J-257	Ph	H	H	H	m-tolyl	H	H
J-258	Ph	H	H	H	p-tolyl	H	H
J-259	1-naphthyl	H	H	H	2-naphthyl	H	H
J-260	1-naphthyl	H	H	H	o-biphenyl	H	H
J-261	1-naphthyl	H	H	H	m-biphenyl	H	H
J-262	1-naphthyl	H	H	H	p-biphenyl	H	H
J-263	1-naphthyl	H	H	H	O-tolyl	H	H
J-264	1-naphthyl	H	H	H	m-tolyl	H	H
J-265	1-naphthyl	H	H	H	p-tolyl	H	H
J-266	2-naphthyl	H	H	H	o-biphenyl	H	H
J-267	2-naphthyl	H	H	H	m-biphenyl	H	H
J-268	2-naphthyl	H	H	H	p-biphenyl	H	H
J-269	2-naphthyl	H	H	H	O-tolyl	H	H
J-270	2-naphthyl	H	H	H	m-tolyl	H	H
J-271	2-naphthyl	H	H	H	p-tolyl	H	H
J-272	o-biphenyl	H	H	H	m-biphenyl	H	H
J-273	o-biphenyl	H	H	H	p-biphenyl	H	H
J-274	o-biphenyl	H	H	H	O-tolyl	H	H
J-275	o-biphenyl	H	H	H	m-tolyl	H	H
J-276	o-biphenyl	H	H	H	p-tolyl	H	H
J-277	m-biphenyl	H	H	H	p-biphenyl	H	H
J-278	m-biphenyl	H	H	H	O-tolyl	H	H
J-279	m-biphenyl	H	H	H	m-tolyl	H	H
J-280	m-biphenyl	H	H	H	p-tolyl	H	H
J-281	p-biphenyl	H	H	H	O-tolyl	H	H
J-282	p-biphenyl	H	H	H	m-tolyl	H	H
J-283	p-biphenyl	H	H	H	p-tolyl	H	H
J-284	O-tolyl	H	H	H	m-tolyl	H	H
J-285	O-tolyl	H	H	H	p-tolyl	H	H
J-286	m-tolyl	H	H	H	p-tolyl	H	H

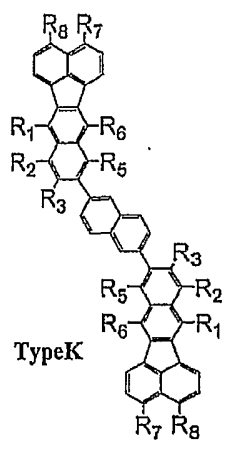

	R ₁	R ₂	R ₃	R ₅	R ₆	R ₇	R ₈
K-1	H	H	H	H	H	H	H
K-2	Ph	H	H	H	Ph	H	H
K-3	Ph	Ph	H	H	Ph	H	H
K-4	Ph	H	H	Ph	Ph	H	H
K-5	Ph	Ph	H	Ph	Ph	H	H
K-6	Ph	H	Ph	H	Ph	H	H
K-7	Ph	H	H	H	Ph	Ph	H
K-8	Ph	H	H	H	Ph	H	Ph
K-9	Ph	H	H	H	Ph	Ph	Ph
K-10	Ph	H	H	H	Ph	1-naphthyl	H
K-11	Ph	H	H	H	Ph	H	1-naphthyl
K-12	Ph	H	H	H	Ph	1-naphthyl	1-naphthyl
K-13	Ph	H	H	H	Ph	2-naphthyl	H
K-14	Ph	H	H	H	Ph	H	2-naphthyl
K-15	Ph	H	H	H	Ph	2-naphthyl	2-naphthyl
K-16	Ph	H	H	H	Ph	o-biphenyl	H
K-17	Ph	H	H	H	Ph	H	o-biphenyl
K-18	Ph	H	H	H	Ph	o-biphenyl	o-biphenyl
K-19	Ph	H	H	H	Ph	m-biphenyl	H
K-20	Ph	H	H	H	Ph	H	m-biphenyl
K-21	Ph	H	H	H	Ph	m-biphenyl	m-biphenyl
K-22	Ph	H	H	H	Ph	p-biphenyl	H
K-23	Ph	H	H	H	Ph	H	p-biphenyl
K-24	Ph	H	H	H	Ph	p-biphenyl	p-biphenyl
K-25	1-naphthyl	H	H	H	1-naphthyl	H	H
K-26	1-naphthyl	Ph	H	H	1-naphthyl	H	H
K-27	1-naphthyl	H	H	Ph	1-naphthyl	H	H
K-28	1-naphthyl	Ph	H	Ph	1-naphthyl	H	H
K-29	1-naphthyl	H	Ph	H	1-naphthyl	H	H
K-30	1-naphthyl	H	H	H	1-naphthyl	Ph	H
K-31	1-naphthyl	H	H	H	1-naphthyl	H	Ph
K-32	1-naphthyl	H	H	H	1-naphthyl	Ph	Ph
K-33	1-naphthyl	H	H	H	1-naphthyl	1-naphthyl	H
K-34	1-naphthyl	H	H	H	1-naphthyl	H	1-naphthyl
K-35	1-naphthyl	H	H	H	1-naphthyl	1-naphthyl	1-naphthyl
K-36	1-naphthyl	H	H	H	1-naphthyl	2-naphthyl	H
K-37	1-naphthyl	H	H	H	1-naphthyl	H	2-naphthyl
K-38	1-naphthyl	H	H	H	1-naphthyl	2-naphthyl	2-naphthyl
K-39	1-naphthyl	H	H	H	1-naphthyl	o-biphenyl	H
K-40	1-naphthyl	H	H	H	1-naphthyl	H	o-biphenyl
K-41	1-naphthyl	H	H	H	1-naphthyl	o-biphenyl	o-biphenyl
K-42	1-naphthyl	H	H	H	1-naphthyl	m-biphenyl	H
K-43	1-naphthyl	H	H	H	1-naphthyl	H	m-biphenyl
K-44	1-naphthyl	H	H	H	1-naphthyl	m-biphenyl	m-biphenyl
K-45	1-naphthyl	H	H	H	1-naphthyl	p-biphenyl	H
K-46	1-naphthyl	H	H	H	1-naphthyl	H	p-biphenyl
K-47	1-naphthyl	H	H	H	1-naphthyl	p-biphenyl	p-biphenyl



	R ₁	R ₂	R ₃	R ₅	R ₆	R ₇	R ₈
K-48	2-naphthyl	H	H	H	2-naphthyl	H	H
K-49	2-naphthyl	Ph	H	H	2-naphthyl	H	H
K-50	2-naphthyl	H	H	Ph	2-naphthyl	H	H
K-51	2-naphthyl	Ph	H	Ph	2-naphthyl	H	H
K-52	2-naphthyl	H	Ph	H	2-naphthyl	H	H
K-53	2-naphthyl	H	H	H	2-naphthyl	Ph	H
K-54	2-naphthyl	H	H	H	2-naphthyl	H	Ph
K-55	2-naphthyl	H	H	H	2-naphthyl	Ph	Ph
K-56	2-naphthyl	H	H	H	2-naphthyl	1-naphthyl	H
K-57	2-naphthyl	H	H	H	2-naphthyl	H	1-naphthyl
K-58	2-naphthyl	H	H	H	2-naphthyl	1-naphthyl	1-naphthyl
K-59	2-naphthyl	H	H	H	2-naphthyl	2-naphthyl	H
K-60	2-naphthyl	H	H	H	2-naphthyl	H	2-naphthyl
K-61	2-naphthyl	H	H	H	2-naphthyl	2-naphthyl	2-naphthyl
K-62	2-naphthyl	H	H	H	2-naphthyl	o-biphenyl	H
K-63	2-naphthyl	H	H	H	2-naphthyl	H	o-biphenyl
K-64	2-naphthyl	H	H	H	2-naphthyl	o-biphenyl	o-biphenyl
K-65	2-naphthyl	H	H	H	2-naphthyl	m-biphenyl	H
K-66	2-naphthyl	H	H	H	2-naphthyl	H	m-biphenyl
K-67	2-naphthyl	H	H	H	2-naphthyl	m-biphenyl	m-biphenyl
K-68	2-naphthyl	H	H	H	2-naphthyl	p-biphenyl	H
K-69	2-naphthyl	H	H	H	2-naphthyl	H	p-biphenyl
K-70	2-naphthyl	H	H	H	2-naphthyl	p-biphenyl	p-biphenyl
K-71	o-biphenyl	H	H	H	o-biphenyl	H	H
K-72	o-biphenyl	Ph	H	H	o-biphenyl	H	H
K-73	o-biphenyl	H	H	Ph	o-biphenyl	H	H
K-74	o-biphenyl	Ph	H	Ph	o-biphenyl	H	H
K-75	o-biphenyl	H	Ph	H	o-biphenyl	H	H
K-76	o-biphenyl	H	H	H	o-biphenyl	Ph	H
K-77	o-biphenyl	H	H	H	o-biphenyl	H	Ph
K-78	o-biphenyl	H	H	H	o-biphenyl	Ph	Ph
K-79	o-biphenyl	H	H	H	o-biphenyl	1-naphthyl	H
K-80	o-biphenyl	H	H	H	o-biphenyl	H	1-naphthyl
K-81	o-biphenyl	H	H	H	o-biphenyl	1-naphthyl	1-naphthyl
K-82	o-biphenyl	H	H	H	o-biphenyl	2-naphthyl	H
K-83	o-biphenyl	H	H	H	o-biphenyl	H	2-naphthyl
K-84	o-biphenyl	H	H	H	o-biphenyl	2-naphthyl	2-naphthyl
K-85	o-biphenyl	H	H	H	o-biphenyl	o-biphenyl	H
K-86	o-biphenyl	H	H	H	o-biphenyl	H	o-biphenyl
K-87	o-biphenyl	H	H	H	o-biphenyl	o-biphenyl	o-biphenyl
K-88	o-biphenyl	H	H	H	o-biphenyl	m-biphenyl	H
K-89	o-biphenyl	H	H	H	o-biphenyl	H	m-biphenyl
K-90	o-biphenyl	H	H	H	o-biphenyl	m-biphenyl	m-biphenyl
K-91	o-biphenyl	H	H	H	o-biphenyl	p-biphenyl	H
K-92	o-biphenyl	H	H	H	o-biphenyl	H	p-biphenyl
K-93	o-biphenyl	H	H	H	o-biphenyl	p-biphenyl	p-biphenyl

	R ₁	R ₂	R ₃	R ₅	R ₆	R ₇	R ₈	
 <p>TypeK</p>	K-94	m-biphenyl	H	H	H	m-biphenyl	H	
	K-95	m-biphenyl	Ph	H	H	m-biphenyl	H	
	K-96	m-biphenyl	H	H	Ph	m-biphenyl	H	
	K-97	m-biphenyl	Ph	H	Ph	m-biphenyl	H	
	K-98	m-biphenyl	H	Ph	H	m-biphenyl	H	
	K-99	m-biphenyl	H	H	H	m-biphenyl	Ph	
	K-100	m-biphenyl	H	H	H	m-biphenyl	H	
	K-101	m-biphenyl	H	H	H	m-biphenyl	Ph	
	K-102	m-biphenyl	H	H	H	m-biphenyl	1-naphthyl	H
	K-103	m-biphenyl	H	H	H	m-biphenyl	H	1-naphthyl
	K-104	m-biphenyl	H	H	H	m-biphenyl	1-naphthyl	1-naphthyl
	K-105	m-biphenyl	H	H	H	m-biphenyl	2-naphthyl	H
	K-106	m-biphenyl	H	H	H	m-biphenyl	H	2-naphthyl
	K-107	m-biphenyl	H	H	H	m-biphenyl	2-naphthyl	2-naphthyl
	K-108	m-biphenyl	H	H	H	m-biphenyl	o-biphenyl	H
	K-109	m-biphenyl	H	H	H	m-biphenyl	H	o-biphenyl
 <p>1-naphthyl</p>  <p>2-naphthyl</p>  <p>o-biphenyl</p>  <p>m-biphenyl</p>  <p>p-biphenyl</p>	K-110	m-biphenyl	H	H	H	m-biphenyl	o-biphenyl	
	K-111	m-biphenyl	H	H	H	m-biphenyl	m-biphenyl	H
	K-112	m-biphenyl	H	H	H	m-biphenyl	H	m-biphenyl
	K-113	m-biphenyl	H	H	H	m-biphenyl	m-biphenyl	m-biphenyl
	K-114	m-biphenyl	H	H	H	m-biphenyl	p-biphenyl	H
	K-115	m-biphenyl	H	H	H	m-biphenyl	H	p-biphenyl
	K-116	m-biphenyl	H	H	H	m-biphenyl	p-biphenyl	p-biphenyl
	K-117	p-biphenyl	H	H	H	p-biphenyl	H	H
	K-118	p-biphenyl	Ph	H	H	p-biphenyl	H	H
	K-119	p-biphenyl	H	H	Ph	p-biphenyl	H	H
	K-120	p-biphenyl	Ph	H	Ph	p-biphenyl	H	H
	K-121	p-biphenyl	H	Ph	H	p-biphenyl	H	H
	K-122	p-biphenyl	H	H	H	p-biphenyl	Ph	H
	K-123	p-biphenyl	H	H	H	p-biphenyl	H	Ph
	K-124	p-biphenyl	H	H	H	p-biphenyl	Ph	Ph
	K-125	p-biphenyl	H	H	H	p-biphenyl	1-naphthyl	H
K-126	p-biphenyl	H	H	H	p-biphenyl	H	1-naphthyl	
K-127	p-biphenyl	H	H	H	p-biphenyl	1-naphthyl	1-naphthyl	
K-128	p-biphenyl	H	H	H	p-biphenyl	2-naphthyl	H	
K-129	p-biphenyl	H	H	H	p-biphenyl	H	2-naphthyl	
K-130	p-biphenyl	H	H	H	p-biphenyl	2-naphthyl	2-naphthyl	
K-131	p-biphenyl	H	H	H	p-biphenyl	o-biphenyl	H	
K-132	p-biphenyl	H	H	H	p-biphenyl	H	o-biphenyl	
K-133	p-biphenyl	H	H	H	p-biphenyl	o-biphenyl	o-biphenyl	
K-134	p-biphenyl	H	H	H	p-biphenyl	m-biphenyl	H	
K-135	p-biphenyl	H	H	H	p-biphenyl	H	m-biphenyl	
K-136	p-biphenyl	H	H	H	p-biphenyl	m-biphenyl	m-biphenyl	
K-137	p-biphenyl	H	H	H	p-biphenyl	p-biphenyl	H	
K-138	p-biphenyl	H	H	H	p-biphenyl	H	p-biphenyl	
K-139	p-biphenyl	H	H	H	p-biphenyl	p-biphenyl	p-biphenyl	

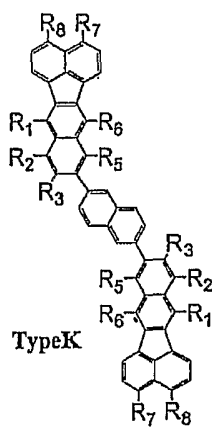
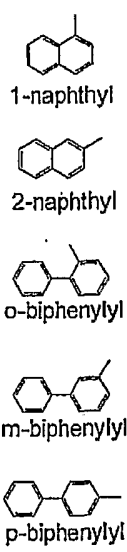
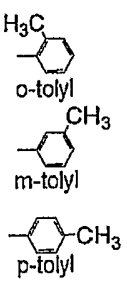
	R ₁	R ₂	R ₃	R ₅	R ₆	R ₇	R ₈
 <p>Type K</p>	K-140	o-tolyl	H	H	H	o-tolyl	H
	K-141	o-tolyl	Ph	H	Ph	o-tolyl	H
	K-142	o-tolyl	H	Ph	H	o-tolyl	H
	K-143	o-tolyl	H	H	H	o-tolyl	Ph
	K-144	o-tolyl	H	H	H	o-tolyl	H
	K-145	o-tolyl	H	H	H	o-tolyl	1-naphthyl
	K-146	o-tolyl	H	H	H	o-tolyl	H
	K-147	o-tolyl	H	H	H	o-tolyl	2-naphthyl
	K-148	o-tolyl	H	H	H	o-tolyl	H
	K-149	o-tolyl	H	H	H	o-tolyl	o-biphenyl
	K-150	o-tolyl	H	H	H	o-tolyl	H
	K-151	o-tolyl	H	H	H	o-tolyl	m-biphenyl
	K-152	o-tolyl	H	H	H	o-tolyl	H
	K-153	o-tolyl	H	H	H	o-tolyl	p-biphenyl
	K-154	o-tolyl	H	H	H	o-tolyl	H
K-155	o-tolyl	H	H	H	o-tolyl	o-tolyl	
 <p>1-naphthyl</p> <p>2-naphthyl</p> <p>o-biphenyl</p> <p>m-biphenyl</p> <p>p-biphenyl</p>	K-156	o-tolyl	H	H	H	o-tolyl	o-tolyl
	K-157	m-tolyl	H	H	H	m-tolyl	H
	K-158	m-tolyl	Ph	H	Ph	m-tolyl	H
	K-159	m-tolyl	H	Ph	H	m-tolyl	H
	K-160	m-tolyl	H	H	H	m-tolyl	Ph
	K-161	m-tolyl	H	H	H	m-tolyl	H
	K-162	m-tolyl	H	H	H	m-tolyl	1-naphthyl
	K-163	m-tolyl	H	H	H	m-tolyl	H
	K-164	m-tolyl	H	H	H	m-tolyl	2-naphthyl
	K-165	m-tolyl	H	H	H	m-tolyl	H
	K-166	m-tolyl	H	H	H	m-tolyl	o-biphenyl
	K-167	m-tolyl	H	H	H	m-tolyl	H
	K-168	m-tolyl	H	H	H	m-tolyl	m-biphenyl
	K-169	m-tolyl	H	H	H	m-tolyl	H
	K-170	m-tolyl	H	H	H	m-tolyl	p-biphenyl
	K-171	m-tolyl	H	H	H	m-tolyl	H
	K-172	m-tolyl	H	H	H	m-tolyl	m-tolyl
	K-173	m-tolyl	H	H	H	m-tolyl	H
 <p>o-tolyl</p> <p>m-tolyl</p> <p>p-tolyl</p>	K-174	p-tolyl	H	H	H	p-tolyl	H
	K-175	p-tolyl	Ph	H	Ph	p-tolyl	H
	K-176	p-tolyl	H	Ph	H	p-tolyl	H
	K-177	p-tolyl	H	H	H	p-tolyl	Ph
	K-178	p-tolyl	H	H	H	p-tolyl	H
	K-179	p-tolyl	H	H	H	p-tolyl	1-naphthyl
	K-180	p-tolyl	H	H	H	p-tolyl	H
	K-181	p-tolyl	H	H	H	p-tolyl	2-naphthyl
	K-182	p-tolyl	H	H	H	p-tolyl	H
	K-183	p-tolyl	H	H	H	p-tolyl	o-biphenyl
	K-184	p-tolyl	H	H	H	p-tolyl	H
	K-185	p-tolyl	H	H	H	p-tolyl	m-biphenyl
	K-186	p-tolyl	H	H	H	p-tolyl	H
	K-187	p-tolyl	H	H	H	p-tolyl	p-biphenyl
	K-188	p-tolyl	H	H	H	p-tolyl	H
	K-189	p-tolyl	H	H	H	p-tolyl	p-tolyl
	K-190	p-tolyl	H	H	H	p-tolyl	H

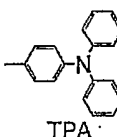
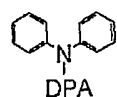
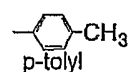
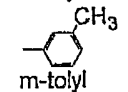
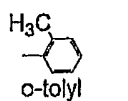
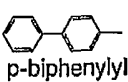
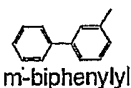
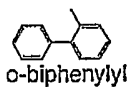
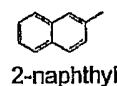
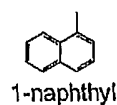
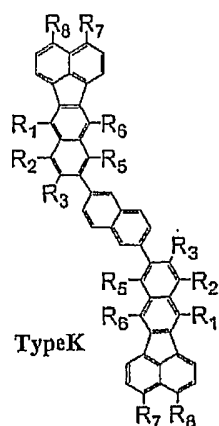

	R ₁	R ₂	R ₃	R ₅	R ₆	R ₇	R ₈
K-191	Ph	H	-CH ₃	H	Ph	H	H
K-192	1-naphthyl	H	-CH ₃	H	1-naphthyl	H	H
K-193	2-naphthyl	H	-CH ₃	H	2-naphthyl	H	H
K-194	o-biphenylyl	H	-CH ₃	H	o-biphenylyl	H	H
K-195	m-biphenylyl	H	-CH ₃	H	m-biphenylyl	H	H
K-196	p-biphenylyl	H	-CH ₃	H	p-biphenylyl	H	H
K-197	o-tolyl	H	-CH ₃	H	o-tolyl	H	H
K-198	m-tolyl	H	-CH ₃	H	m-tolyl	H	H
K-199	p-tolyl	H	-CH ₃	H	p-tolyl	H	H
K-200	Ph	H	H	H	Ph	-CH ₃	H
K-201	1-naphthyl	H	H	H	1-naphthyl	-CH ₃	H
K-202	2-naphthyl	H	H	H	2-naphthyl	-CH ₃	H
K-203	o-biphenylyl	H	H	H	o-biphenylyl	-CH ₃	H
K-204	m-biphenylyl	H	H	H	m-biphenylyl	-CH ₃	H
K-205	p-biphenylyl	H	H	H	p-biphenylyl	-CH ₃	H
K-206	o-tolyl	H	H	H	o-tolyl	-CH ₃	H
K-207	m-tolyl	H	H	H	m-tolyl	-CH ₃	H
K-208	p-tolyl	H	H	H	p-tolyl	-CH ₃	H
K-209	Ph	H	H	H	Ph	H	-CH ₃
K-210	1-naphthyl	H	H	H	1-naphthyl	H	-CH ₃
K-211	2-naphthyl	H	H	H	2-naphthyl	H	-CH ₃
K-212	o-biphenylyl	H	H	H	o-biphenylyl	H	-CH ₃
K-213	m-biphenylyl	H	H	H	m-biphenylyl	H	-CH ₃
K-214	p-biphenylyl	H	H	H	p-biphenylyl	H	-CH ₃
K-215	o-tolyl	H	H	H	o-tolyl	H	-CH ₃
K-216	m-tolyl	H	H	H	m-tolyl	H	-CH ₃
K-217	p-tolyl	H	H	H	p-tolyl	H	-CH ₃
K-218	Ph	H	H	H	Ph	-CH ₃	-CH ₃
K-219	1-naphthyl	H	H	H	1-naphthyl	-CH ₃	-CH ₃
K-220	2-naphthyl	H	H	H	2-naphthyl	-CH ₃	-CH ₃
K-221	o-biphenylyl	H	H	H	o-biphenylyl	-CH ₃	-CH ₃
K-222	m-biphenylyl	H	H	H	m-biphenylyl	-CH ₃	-CH ₃
K-223	p-biphenylyl	H	H	H	p-biphenylyl	-CH ₃	-CH ₃
K-224	o-tolyl	H	H	H	o-tolyl	-CH ₃	-CH ₃
K-225	m-tolyl	H	H	H	m-tolyl	-CH ₃	-CH ₃
K-226	p-tolyl	H	H	H	p-tolyl	-CH ₃	-CH ₃
K-227	Ph	H	H	H	Ph	H	DPA
K-228	1-naphthyl	H	H	H	1-naphthyl	H	DPA
K-229	2-naphthyl	H	H	H	2-naphthyl	H	DPA
K-230	o-biphenylyl	H	H	H	o-biphenylyl	H	DPA
K-231	m-biphenylyl	H	H	H	m-biphenylyl	H	DPA
K-232	p-biphenylyl	H	H	H	p-biphenylyl	H	DPA
K-233	Ph	H	H	H	Ph	DPA	H
K-234	1-naphthyl	H	H	H	1-naphthyl	DPA	H
K-235	2-naphthyl	H	H	H	2-naphthyl	DPA	H
K-236	o-biphenylyl	H	H	H	o-biphenylyl	DPA	H
K-237	m-biphenylyl	H	H	H	m-biphenylyl	DPA	H
K-238	p-biphenylyl	H	H	H	p-biphenylyl	DPA	H
K-239	Ph	H	H	H	Ph	H	TPA
K-240	1-naphthyl	H	H	H	1-naphthyl	H	TPA
K-241	2-naphthyl	H	H	H	2-naphthyl	H	TPA
K-242	o-biphenylyl	H	H	H	o-biphenylyl	H	TPA
K-243	m-biphenylyl	H	H	H	m-biphenylyl	H	TPA
K-244	p-biphenylyl	H	H	H	p-biphenylyl	H	TPA
K-245	Ph	H	H	H	Ph	TPA	H
K-246	1-naphthyl	H	H	H	1-naphthyl	TPA	H
K-247	2-naphthyl	H	H	H	2-naphthyl	TPA	H
K-248	o-biphenylyl	H	H	H	o-biphenylyl	TPA	H
K-249	m-biphenylyl	H	H	H	m-biphenylyl	TPA	H
K-250	p-biphenylyl	H	H	H	p-biphenylyl	TPA	H

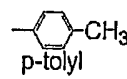
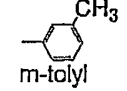
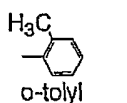
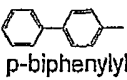
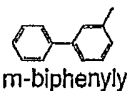
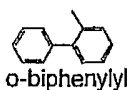
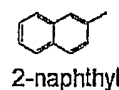
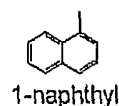
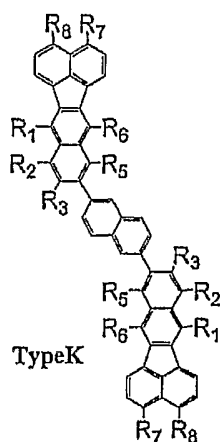

	R ₁	R ₂	R ₃	R ₅	R ₆	R ₇	R ₈
K-251	Ph	H	H	H	1-naphthyl	H	H
K-252	Ph	H	H	H	2-naphthyl	H	H
K-253	Ph	H	H	H	o-biphenyl	H	H
K-254	Ph	H	H	H	m-biphenyl	H	H
K-255	Ph	H	H	H	p-biphenyl	H	H
K-256	Ph	H	H	H	O-tolyl	H	H
K-257	Ph	H	H	H	m-tolyl	H	H
K-258	Ph	H	H	H	p-tolyl	H	H
K-259	1-naphthyl	H	H	H	2-naphthyl	H	H
K-260	1-naphthyl	H	H	H	o-biphenyl	H	H
K-261	1-naphthyl	H	H	H	m-biphenyl	H	H
K-262	1-naphthyl	H	H	H	p-biphenyl	H	H
K-263	1-naphthyl	H	H	H	O-tolyl	H	H
K-264	1-naphthyl	H	H	H	m-tolyl	H	H
K-265	1-naphthyl	H	H	H	p-tolyl	H	H
K-266	2-naphthyl	H	H	H	o-biphenyl	H	H
K-267	2-naphthyl	H	H	H	m-biphenyl	H	H
K-268	2-naphthyl	H	H	H	p-biphenyl	H	H
K-269	2-naphthyl	H	H	H	O-tolyl	H	H
K-270	2-naphthyl	H	H	H	m-tolyl	H	H
K-271	2-naphthyl	H	H	H	p-tolyl	H	H
K-272	o-biphenyl	H	H	H	m-biphenyl	H	H
K-273	o-biphenyl	H	H	H	p-biphenyl	H	H
K-274	o-biphenyl	H	H	H	O-tolyl	H	H
K-275	o-biphenyl	H	H	H	m-tolyl	H	H
K-276	o-biphenyl	H	H	H	p-tolyl	H	H
K-277	m-biphenyl	H	H	H	p-biphenyl	H	H
K-278	m-biphenyl	H	H	H	O-tolyl	H	H
K-279	m-biphenyl	H	H	H	m-tolyl	H	H
K-280	m-biphenyl	H	H	H	p-tolyl	H	H
K-281	p-biphenyl	H	H	H	O-tolyl	H	H
K-282	p-biphenyl	H	H	H	m-tolyl	H	H
K-283	p-biphenyl	H	H	H	p-tolyl	H	H
K-284	O-tolyl	H	H	H	m-tolyl	H	H
K-285	O-tolyl	H	H	H	p-tolyl	H	H
K-286	m-tolyl	H	H	H	p-tolyl	H	H

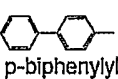
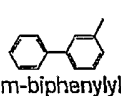
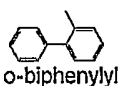
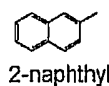
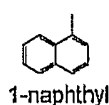
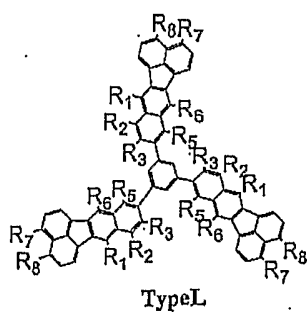

	R ₁	R ₂	R ₃	R ₅	R ₆	R ₇	R ₈
L-1	H	H	H	H	H	H	H
L-2	Ph	H	H	H	Ph	H	H
L-3	Ph	Ph	H	H	Ph	H	H
L-4	Ph	H	H	Ph	Ph	H	H
L-5	Ph	Ph	H	Ph	Ph	H	H
L-6	Ph	H	Ph	H	Ph	H	H
L-7	Ph	H	H	H	Ph	Ph	H
L-8	Ph	H	H	H	Ph	H	Ph
L-9	Ph	H	H	H	Ph	Ph	Ph
L-10	Ph	H	H	H	Ph	1-naphthyl	H
L-11	Ph	H	H	H	Ph	H	1-naphthyl
L-12	Ph	H	H	H	Ph	1-naphthyl	1-naphthyl
L-13	Ph	H	H	H	Ph	2-naphthyl	H
L-14	Ph	H	H	H	Ph	H	2-naphthyl
L-15	Ph	H	H	H	Ph	2-naphthyl	2-naphthyl
L-16	Ph	H	H	H	Ph	o-biphenyl	H
L-17	Ph	H	H	H	Ph	H	o-biphenyl
L-18	Ph	H	H	H	Ph	o-biphenyl	o-biphenyl
L-19	Ph	H	H	H	Ph	m-biphenyl	H
L-20	Ph	H	H	H	Ph	H	m-biphenyl
L-21	Ph	H	H	H	Ph	m-biphenyl	m-biphenyl
L-22	Ph	H	H	H	Ph	p-biphenyl	H
L-23	Ph	H	H	H	Ph	H	p-biphenyl
L-24	Ph	H	H	H	Ph	p-biphenyl	p-biphenyl
L-25	1-naphthyl	H	H	H	1-naphthyl	H	H
L-26	1-naphthyl	Ph	H	H	1-naphthyl	H	H
L-27	1-naphthyl	H	H	Ph	1-naphthyl	H	H
L-28	1-naphthyl	Ph	H	Ph	1-naphthyl	H	H
L-29	1-naphthyl	H	Ph	H	1-naphthyl	H	H
L-30	1-naphthyl	H	H	H	1-naphthyl	Ph	H
L-31	1-naphthyl	H	H	H	1-naphthyl	H	Ph
L-32	1-naphthyl	H	H	H	1-naphthyl	Ph	Ph
L-33	1-naphthyl	H	H	H	1-naphthyl	1-naphthyl	H
L-34	1-naphthyl	H	H	H	1-naphthyl	H	1-naphthyl
L-35	1-naphthyl	H	H	H	1-naphthyl	1-naphthyl	1-naphthyl
L-36	1-naphthyl	H	H	H	1-naphthyl	2-naphthyl	H
L-37	1-naphthyl	H	H	H	1-naphthyl	H	2-naphthyl
L-38	1-naphthyl	H	H	H	1-naphthyl	2-naphthyl	2-naphthyl
L-39	1-naphthyl	H	H	H	1-naphthyl	o-biphenyl	H
L-40	1-naphthyl	H	H	H	1-naphthyl	H	o-biphenyl
L-41	1-naphthyl	H	H	H	1-naphthyl	o-biphenyl	o-biphenyl
L-42	1-naphthyl	H	H	H	1-naphthyl	m-biphenyl	H
L-43	1-naphthyl	H	H	H	1-naphthyl	H	m-biphenyl
L-44	1-naphthyl	H	H	H	1-naphthyl	m-biphenyl	m-biphenyl
L-45	1-naphthyl	H	H	H	1-naphthyl	p-biphenyl	H
L-46	1-naphthyl	H	H	H	1-naphthyl	H	p-biphenyl
L-47	1-naphthyl	H	H	H	1-naphthyl	p-biphenyl	p-biphenyl

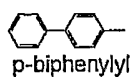
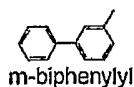
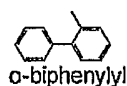
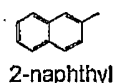
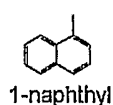
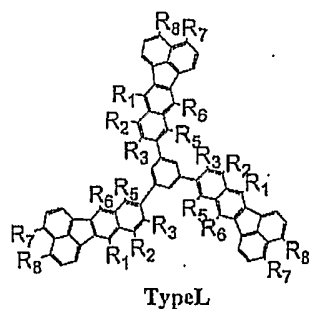

	R ₁	R ₂	R ₃	R ₅	R ₆	R ₇	R ₈
L-48	2-naphthyl	H	H	H	2-naphthyl	H	H
L-49	2-naphthyl	Ph	H	H	2-naphthyl	H	H
L-50	2-naphthyl	H	H	Ph	2-naphthyl	H	H
L-51	2-naphthyl	Ph	H	Ph	2-naphthyl	H	H
L-52	2-naphthyl	H	Ph	H	2-naphthyl	H	H
L-53	2-naphthyl	H	H	H	2-naphthyl	Ph	H
L-54	2-naphthyl	H	H	H	2-naphthyl	H	Ph
L-55	2-naphthyl	H	H	H	2-naphthyl	Ph	Ph
L-56	2-naphthyl	H	H	H	2-naphthyl	1-naphthyl	H
L-57	2-naphthyl	H	H	H	2-naphthyl	H	1-naphthyl
L-58	2-naphthyl	H	H	H	2-naphthyl	1-naphthyl	1-naphthyl
L-59	2-naphthyl	H	H	H	2-naphthyl	2-naphthyl	H
L-60	2-naphthyl	H	H	H	2-naphthyl	H	2-naphthyl
L-61	2-naphthyl	H	H	H	2-naphthyl	2-naphthyl	2-naphthyl
L-62	2-naphthyl	H	H	H	2-naphthyl	o-biphenyl	H
L-63	2-naphthyl	H	H	H	2-naphthyl	H	o-biphenyl
L-64	2-naphthyl	H	H	H	2-naphthyl	o-biphenyl	o-biphenyl
L-65	2-naphthyl	H	H	H	2-naphthyl	m-biphenyl	H
L-66	2-naphthyl	H	H	H	2-naphthyl	H	m-biphenyl
L-67	2-naphthyl	H	H	H	2-naphthyl	m-biphenyl	m-biphenyl
L-68	2-naphthyl	H	H	H	2-naphthyl	p-biphenyl	H
L-69	2-naphthyl	H	H	H	2-naphthyl	H	p-biphenyl
L-70	2-naphthyl	H	H	H	2-naphthyl	p-biphenyl	p-biphenyl
L-71	o-biphenyl	H	H	H	o-biphenyl	H	H
L-72	o-biphenyl	Ph	H	H	o-biphenyl	H	H
L-73	o-biphenyl	H	H	Ph	o-biphenyl	H	H
L-74	o-biphenyl	Ph	H	Ph	o-biphenyl	H	H
L-75	o-biphenyl	H	Ph	H	o-biphenyl	H	H
L-76	o-biphenyl	H	H	H	o-biphenyl	Ph	H
L-77	o-biphenyl	H	H	H	o-biphenyl	H	Ph
L-78	o-biphenyl	H	H	H	o-biphenyl	Ph	Ph
L-79	o-biphenyl	H	H	H	o-biphenyl	1-naphthyl	H
L-80	o-biphenyl	H	H	H	o-biphenyl	H	1-naphthyl
L-81	o-biphenyl	H	H	H	o-biphenyl	1-naphthyl	1-naphthyl
L-82	o-biphenyl	H	H	H	o-biphenyl	2-naphthyl	H
L-83	o-biphenyl	H	H	H	o-biphenyl	H	2-naphthyl
L-84	o-biphenyl	H	H	H	o-biphenyl	2-naphthyl	2-naphthyl
L-85	o-biphenyl	H	H	H	o-biphenyl	o-biphenyl	H
L-86	o-biphenyl	H	H	H	o-biphenyl	H	o-biphenyl
L-87	o-biphenyl	H	H	H	o-biphenyl	o-biphenyl	o-biphenyl
L-88	o-biphenyl	H	H	H	o-biphenyl	m-biphenyl	H
L-89	o-biphenyl	H	H	H	o-biphenyl	H	m-biphenyl
L-90	o-biphenyl	H	H	H	o-biphenyl	m-biphenyl	m-biphenyl
L-91	o-biphenyl	H	H	H	o-biphenyl	p-biphenyl	H
L-92	o-biphenyl	H	H	H	o-biphenyl	H	p-biphenyl
L-93	o-biphenyl	H	H	H	o-biphenyl	p-biphenyl	p-biphenyl

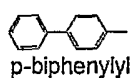
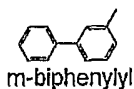
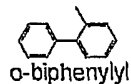
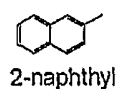
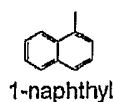
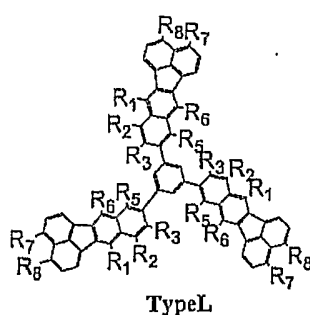

	R ₁	R ₂	R ₃	R ₅	R ₆	R ₇	R ₈
L-94	m-biphenyl	H	H	H	m-biphenyl	H	H
L-95	m-biphenyl	Ph	H	H	m-biphenyl	H	H
L-96	m-biphenyl	H	H	Ph	m-biphenyl	H	H
L-97	m-biphenyl	Ph	H	Ph	m-biphenyl	H	H
L-98	m-biphenyl	H	Ph	H	m-biphenyl	H	H
L-99	m-biphenyl	H	H	H	m-biphenyl	Ph	H
L-100	m-biphenyl	H	H	H	m-biphenyl	H	Ph
L-101	m-biphenyl	H	H	H	m-biphenyl	Ph	Ph
L-102	m-biphenyl	H	H	H	m-biphenyl	1-naphthyl	H
L-103	m-biphenyl	H	H	H	m-biphenyl	H	1-naphthyl
L-104	m-biphenyl	H	H	H	m-biphenyl	1-naphthyl	1-naphthyl
L-105	m-biphenyl	H	H	H	m-biphenyl	2-naphthyl	H
L-106	m-biphenyl	H	H	H	m-biphenyl	H	2-naphthyl
L-107	m-biphenyl	H	H	H	m-biphenyl	2-naphthyl	2-naphthyl
L-108	m-biphenyl	H	H	H	m-biphenyl	o-biphenyl	H
L-109	m-biphenyl	H	H	H	m-biphenyl	H	o-biphenyl
L-110	m-biphenyl	H	H	H	m-biphenyl	o-biphenyl	o-biphenyl
L-111	m-biphenyl	H	H	H	m-biphenyl	m-biphenyl	H
L-112	m-biphenyl	H	H	H	m-biphenyl	H	m-biphenyl
L-113	m-biphenyl	H	H	H	m-biphenyl	m-biphenyl	m-biphenyl
L-114	m-biphenyl	H	H	H	m-biphenyl	p-biphenyl	H
L-115	m-biphenyl	H	H	H	m-biphenyl	H	p-biphenyl
L-116	m-biphenyl	H	H	H	m-biphenyl	p-biphenyl	p-biphenyl
L-117	p-biphenyl	H	H	H	p-biphenyl	H	H
L-118	p-biphenyl	Ph	H	H	p-biphenyl	H	H
L-119	p-biphenyl	H	H	Ph	p-biphenyl	H	H
L-120	p-biphenyl	Ph	H	Ph	p-biphenyl	H	H
L-121	p-biphenyl	H	Ph	H	p-biphenyl	H	H
L-122	p-biphenyl	H	H	H	p-biphenyl	Ph	H
L-123	p-biphenyl	H	H	H	p-biphenyl	H	Ph
L-124	p-biphenyl	H	H	H	p-biphenyl	Ph	Ph
L-125	p-biphenyl	H	H	H	p-biphenyl	1-naphthyl	H
L-126	p-biphenyl	H	H	H	p-biphenyl	H	1-naphthyl
L-127	p-biphenyl	H	H	H	p-biphenyl	1-naphthyl	1-naphthyl
L-128	p-biphenyl	H	H	H	p-biphenyl	2-naphthyl	H
L-129	p-biphenyl	H	H	H	p-biphenyl	H	2-naphthyl
L-130	p-biphenyl	H	H	H	p-biphenyl	2-naphthyl	2-naphthyl
L-131	p-biphenyl	H	H	H	p-biphenyl	o-biphenyl	H
L-132	p-biphenyl	H	H	H	p-biphenyl	H	o-biphenyl
L-133	p-biphenyl	H	H	H	p-biphenyl	o-biphenyl	o-biphenyl
L-134	p-biphenyl	H	H	H	p-biphenyl	m-biphenyl	H
L-135	p-biphenyl	H	H	H	p-biphenyl	H	m-biphenyl
L-136	p-biphenyl	H	H	H	p-biphenyl	m-biphenyl	m-biphenyl
L-137	p-biphenyl	H	H	H	p-biphenyl	p-biphenyl	H
L-138	p-biphenyl	H	H	H	p-biphenyl	H	p-biphenyl
L-139	p-biphenyl	H	H	H	p-biphenyl	p-biphenyl	p-biphenyl

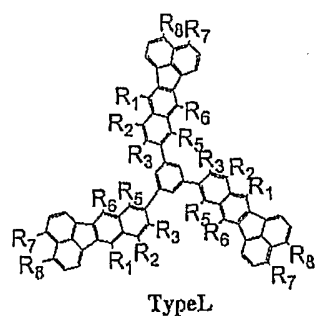

	R ₁	R ₂	R ₃	R ₅	R ₆	R ₇	R ₈
L-140	o-tolyl	H	H	H	o-tolyl	H	H
L-141	o-tolyl	Ph	H	Ph	o-tolyl	H	H
L-142	o-tolyl	H	Ph	H	o-tolyl	H	H
L-143	o-tolyl	H	H	H	o-tolyl	Ph	H
L-144	o-tolyl	H	H	H	o-tolyl	H	Ph
L-145	o-tolyl	H	H	H	o-tolyl	1-naphthyl	H
L-146	o-tolyl	H	H	H	o-tolyl	H	1-naphthyl
L-147	o-tolyl	H	H	H	o-tolyl	2-naphthyl	H
L-148	o-tolyl	H	H	H	o-tolyl	H	2-naphthyl
L-149	o-tolyl	H	H	H	o-tolyl	o-biphenyl	H
L-150	o-tolyl	H	H	H	o-tolyl	H	o-biphenyl
L-151	o-tolyl	H	H	H	o-tolyl	m-biphenyl	H
L-152	o-tolyl	H	H	H	o-tolyl	H	m-biphenyl
L-153	o-tolyl	H	H	H	o-tolyl	p-biphenyl	H
L-154	o-tolyl	H	H	H	o-tolyl	H	p-biphenyl
L-155	o-tolyl	H	H	H	o-tolyl	o-tolyl	H
L-156	o-tolyl	H	H	H	o-tolyl	H	o-tolyl
L-157	m-tolyl	H	H	H	m-tolyl	H	H
L-158	m-tolyl	Ph	H	Ph	m-tolyl	H	H
L-159	m-tolyl	H	Ph	H	m-tolyl	H	H
L-160	m-tolyl	H	H	H	m-tolyl	Ph	H
L-161	m-tolyl	H	H	H	m-tolyl	H	Ph
L-162	m-tolyl	H	H	H	m-tolyl	1-naphthyl	H
L-163	m-tolyl	H	H	H	m-tolyl	H	1-naphthyl
L-164	m-tolyl	H	H	H	m-tolyl	2-naphthyl	H
L-165	m-tolyl	H	H	H	m-tolyl	H	2-naphthyl
L-166	m-tolyl	H	H	H	m-tolyl	o-biphenyl	H
L-167	m-tolyl	H	H	H	m-tolyl	H	o-biphenyl
L-168	m-tolyl	H	H	H	m-tolyl	m-biphenyl	H
L-169	m-tolyl	H	H	H	m-tolyl	H	m-biphenyl
L-170	m-tolyl	H	H	H	m-tolyl	p-biphenyl	H
L-171	m-tolyl	H	H	H	m-tolyl	H	p-biphenyl
L-172	m-tolyl	H	H	H	m-tolyl	m-tolyl	H
L-173	m-tolyl	H	H	H	m-tolyl	H	m-tolyl
L-174	p-tolyl	H	H	H	p-tolyl	H	H
L-175	p-tolyl	Ph	H	Ph	p-tolyl	H	H
L-176	p-tolyl	H	Ph	H	p-tolyl	H	H
L-177	p-tolyl	H	H	H	p-tolyl	Ph	H
L-178	p-tolyl	H	H	H	p-tolyl	H	Ph
L-179	p-tolyl	H	H	H	p-tolyl	1-naphthyl	H
L-180	p-tolyl	H	H	H	p-tolyl	H	1-naphthyl
L-181	p-tolyl	H	H	H	p-tolyl	2-naphthyl	H
L-182	p-tolyl	H	H	H	p-tolyl	H	2-naphthyl
L-183	p-tolyl	H	H	H	p-tolyl	o-biphenyl	H
L-184	p-tolyl	H	H	H	p-tolyl	H	o-biphenyl
L-185	p-tolyl	H	H	H	p-tolyl	m-biphenyl	H
L-186	p-tolyl	H	H	H	p-tolyl	H	m-biphenyl
L-187	p-tolyl	H	H	H	p-tolyl	p-biphenyl	H
L-188	p-tolyl	H	H	H	p-tolyl	H	p-biphenyl
L-189	p-tolyl	H	H	H	p-tolyl	p-tolyl	H
L-190	p-tolyl	H	H	H	p-tolyl	H	p-tolyl

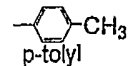
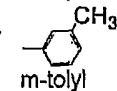
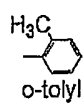
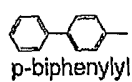
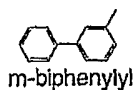
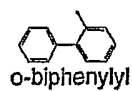
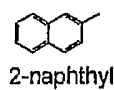
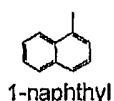

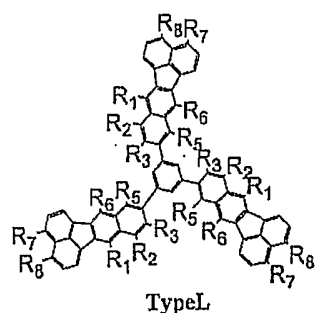

	R ₁	R ₂	R ₃	R ₅	R ₆	R ₇	R ₈
L-191	Ph	H	-CH3	H	Ph	H	H
L-192	1-naphthyl	H	-CH3	H	1-naphthyl	H	H
L-193	2-naphthyl	H	-CH3	H	2-naphthyl	H	H
L-194	o-biphenyl	H	-CH3	H	o-biphenyl	H	H
L-195	m-biphenyl	H	-CH3	H	m-biphenyl	H	H
L-196	p-biphenyl	H	-CH3	H	p-biphenyl	H	H
L-197	o-tolyl	H	-CH3	H	o-tolyl	H	H
L-198	m-tolyl	H	-CH3	H	m-tolyl	H	H
L-199	p-tolyl	H	-CH3	H	p-tolyl	H	H
L-200	Ph	H	H	H	Ph	-CH3	H
L-201	1-naphthyl	H	H	H	1-naphthyl	-CH3	H
L-202	2-naphthyl	H	H	H	2-naphthyl	-CH3	H
L-203	o-biphenyl	H	H	H	o-biphenyl	-CH3	H
L-204	m-biphenyl	H	H	H	m-biphenyl	-CH3	H
L-205	p-biphenyl	H	H	H	p-biphenyl	-CH3	H
L-206	o-tolyl	H	H	H	o-tolyl	-CH3	H
L-207	m-tolyl	H	H	H	m-tolyl	-CH3	H
L-208	p-tolyl	H	H	H	p-tolyl	-CH3	H
L-209	Ph	H	H	H	Ph	H	-CH3
L-210	1-naphthyl	H	H	H	1-naphthyl	H	-CH3
L-211	2-naphthyl	H	H	H	2-naphthyl	H	-CH3
L-212	o-biphenyl	H	H	H	o-biphenyl	H	-CH3
L-213	m-biphenyl	H	H	H	m-biphenyl	H	-CH3
L-214	p-biphenyl	H	H	H	p-biphenyl	H	-CH3
L-215	o-tolyl	H	H	H	o-tolyl	H	-CH3
L-216	m-tolyl	H	H	H	m-tolyl	H	-CH3
L-217	p-tolyl	H	H	H	p-tolyl	H	-CH3
L-218	Ph	H	H	H	Ph	-CH3	-CH3
L-219	1-naphthyl	H	H	H	1-naphthyl	-CH3	-CH3
L-220	2-naphthyl	H	H	H	2-naphthyl	-CH3	-CH3
L-221	o-biphenyl	H	H	H	o-biphenyl	-CH3	-CH3
L-222	m-biphenyl	H	H	H	m-biphenyl	-CH3	-CH3
L-223	p-biphenyl	H	H	H	p-biphenyl	-CH3	-CH3
L-224	o-tolyl	H	H	H	o-tolyl	-CH3	-CH3
L-225	m-tolyl	H	H	H	m-tolyl	-CH3	-CH3
L-226	p-tolyl	H	H	H	p-tolyl	-CH3	-CH3
L-227	Ph	H	H	H	Ph	H	DPA
L-228	1-naphthyl	H	H	H	1-naphthyl	H	DPA
L-229	2-naphthyl	H	H	H	2-naphthyl	H	DPA
L-230	o-biphenyl	H	H	H	o-biphenyl	H	DPA
L-231	m-biphenyl	H	H	H	m-biphenyl	H	DPA
L-232	p-biphenyl	H	H	H	p-biphenyl	H	DPA
L-233	Ph	H	H	H	Ph	DPA	H
L-234	1-naphthyl	H	H	H	1-naphthyl	DPA	H
L-235	2-naphthyl	H	H	H	2-naphthyl	DPA	H
L-236	o-biphenyl	H	H	H	o-biphenyl	DPA	H
L-237	m-biphenyl	H	H	H	m-biphenyl	DPA	H
L-238	p-biphenyl	H	H	H	p-biphenyl	DPA	H
L-239	Ph	H	H	H	Ph	H	TPA
L-240	1-naphthyl	H	H	H	1-naphthyl	H	TPA
L-241	2-naphthyl	H	H	H	2-naphthyl	H	TPA
L-242	o-biphenyl	H	H	H	o-biphenyl	H	TPA
L-243	m-biphenyl	H	H	H	m-biphenyl	H	TPA
L-244	p-biphenyl	H	H	H	p-biphenyl	H	TPA
L-245	Ph	H	H	H	Ph	TPA	H
L-246	1-naphthyl	H	H	H	1-naphthyl	TPA	H
L-247	2-naphthyl	H	H	H	2-naphthyl	TPA	H
L-248	o-biphenyl	H	H	H	o-biphenyl	TPA	H
L-249	m-biphenyl	H	H	H	m-biphenyl	TPA	H
L-250	p-biphenyl	H	H	H	p-biphenyl	TPA	H

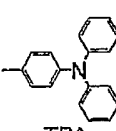
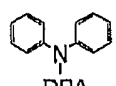
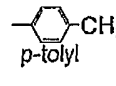
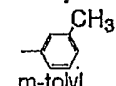
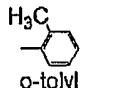
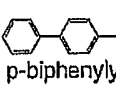
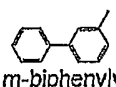
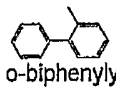
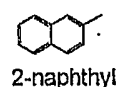
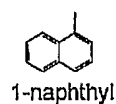

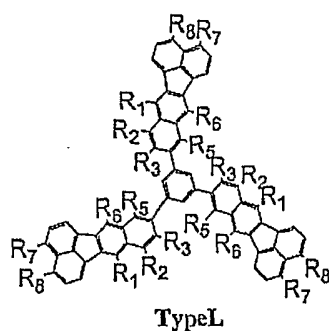

	R ₁	R ₂	R ₃	R ₅	R ₆	R ₇	R ₈
L-251	Ph	H	H	H	1-naphthyl	H	H
L-252	Ph	H	H	H	2-naphthyl	H	H
L-253	Ph	H	H	H	o-biphenyl	H	H
L-254	Ph	H	H	H	m-biphenyl	H	H
L-255	Ph	H	H	H	p-biphenyl	H	H
L-256	Ph	H	H	H	O-tolyl	H	H
L-257	Ph	H	H	H	m-tolyl	H	H
L-258	Ph	H	H	H	p-tolyl	H	H
L-259	1-naphthyl	H	H	H	2-naphthyl	H	H
L-260	1-naphthyl	H	H	H	o-biphenyl	H	H
L-261	1-naphthyl	H	H	H	m-biphenyl	H	H
L-262	1-naphthyl	H	H	H	p-biphenyl	H	H
L-263	1-naphthyl	H	H	H	O-tolyl	H	H
L-264	1-naphthyl	H	H	H	m-tolyl	H	H
L-265	1-naphthyl	H	H	H	p-tolyl	H	H
L-266	2-naphthyl	H	H	H	o-biphenyl	H	H
L-267	2-naphthyl	H	H	H	m-biphenyl	H	H
L-268	2-naphthyl	H	H	H	p-biphenyl	H	H
L-269	2-naphthyl	H	H	H	O-tolyl	H	H
L-270	2-naphthyl	H	H	H	m-tolyl	H	H
L-271	2-naphthyl	H	H	H	p-tolyl	H	H
L-272	o-biphenyl	H	H	H	m-biphenyl	H	H
L-273	o-biphenyl	H	H	H	p-biphenyl	H	H
L-274	o-biphenyl	H	H	H	O-tolyl	H	H
L-275	o-biphenyl	H	H	H	m-tolyl	H	H
L-276	o-biphenyl	H	H	H	p-tolyl	H	H
L-277	m-biphenyl	H	H	H	p-biphenyl	H	H
L-278	m-biphenyl	H	H	H	O-tolyl	H	H
L-279	m-biphenyl	H	H	H	m-tolyl	H	H
L-280	m-biphenyl	H	H	H	p-tolyl	H	H
L-281	p-biphenyl	H	H	H	O-tolyl	H	H
L-282	p-biphenyl	H	H	H	m-tolyl	H	H
L-283	p-biphenyl	H	H	H	p-tolyl	H	H
L-284	O-tolyl	H	H	H	m-tolyl	H	H
L-285	O-tolyl	H	H	H	p-tolyl	H	H
L-286	m-tolyl	H	H	H	p-tolyl	H	H

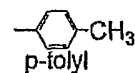
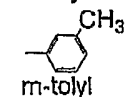
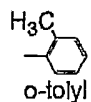
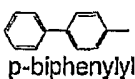
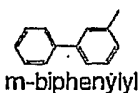
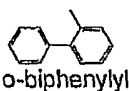
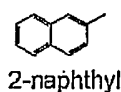
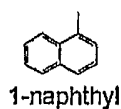

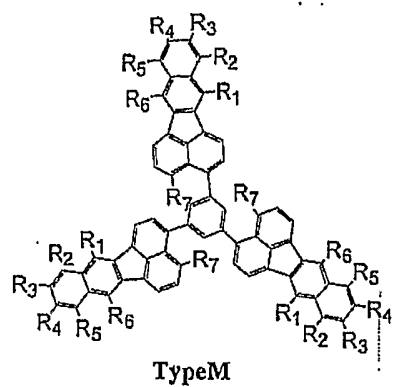

	R ₁	R ₂	R ₃	R ₄	R ₅	R ₆	R ₇
M-1	H	H	H	H	H	H	H
M-2	Ph	H	H	H	H	Ph	H
M-3	Ph	Ph	H	H	Ph	Ph	H
M-4	Ph	H	Ph	Ph	H	Ph	H
M-5	Ph	H	Ph	H	H	Ph	H
M-6	Ph	H	H	H	H	Ph	Ph
M-7	Ph	Me	H	H	Me	Ph	H
M-8	Ph	H	Me	Me	H	Ph	H
M-9	Ph	H	H	H	H	Ph	Me
M-10		H	H	H	H		H
M-11		Ph	H	H	Ph		H
M-12		H	Ph	Ph	H		H
M-13		H	Ph	H	H		H
M-14		H	H	H	H		Ph
M-15		Me	H	H	Me		H
M-16		H	Me	Me	H		H
M-17		H	H	H	H		Me
M-18		H	H	H	H		H
M-19		Ph	H	H	Ph		H
M-20		H	Ph	Ph	H		H
M-21		H	Ph	H	H		H
M-22		H	H	H	H		Ph
M-23		Me	H	H	Me		H
M-24		H	Me	Me	H		H
M-25		H	H	H	H		Me

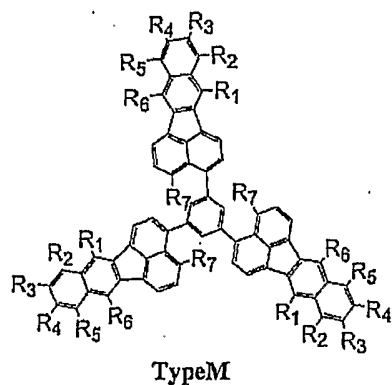

	R ₁	R ₂	R ₃	R ₄	R ₅	R ₆	R ₇
M-26		H	H	H	H		H
M-27		Ph	H	H	Ph		H
M-28		H	Ph	Ph	H		H
M-29		H	Ph	H	H		H
M-30		H	H	H	H		Ph
M-31		Me	H	H	Me		H
M-32		H	Me	Me	H		H
M-33		H	H	H	H		Me
M-34		H	H	H	H		H
M-35		Ph	H	H	Ph		H
M-36		H	Ph	Ph	H		H
M-37		H	Ph	H	H		H
M-38		H	H	H	H		Ph
M-39		Me	H	H	Me		H
M-40		H	Me	Me	H		H
M-41		H	H	H	H		Me
M-42		H	H	H	H		H
M-43		Ph	H	H	Ph		H
M-44		H	Ph	Ph	H		H
M-45		H	Ph	H	H		H
M-46		H	H	H	H		Ph
M-47		Me	H	H	Me		H
M-48		H	Me	Me	H		H
M-49		H	H	H	H		Me

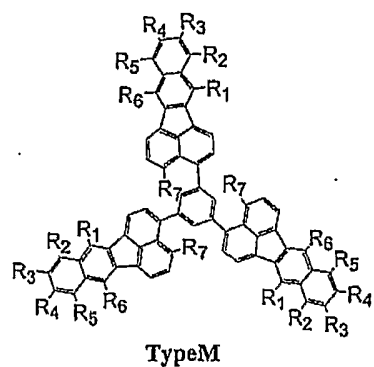

	R ₁	R ₂	R ₃	R ₄	R ₅	R ₆	R ₇
M-50	Ph	H	H	H	H		H
M-51	Ph	H	H	H	H		H
M-52	Ph	H	H	H	H		H
M-53	Ph	H	H	H	H		H
M-54	Ph	H	H	H	H		H
M-55		H	H	H	H		H
M-56		H	H	H	H		H
M-57		H	H	H	H		H
M-58		H	H	H	H		H
M-59		H	H	H	H		H
M-60		H	H	H	H		H
M-61		H	H	H	H		H
M-62		H	H	H	H		H
M-63		H	H	H	H		H
M-64		H	H	H	H		H
M-65	H	Ph	H	H	Ph	H	H
M-66	H		H	H		H	H
M-67	H		H	H		H	H
M-68	H		H	H		H	H
M-69	H		H	H		H	H
M-70	H		H	H		H	H
M-71	H	H			H	H	H
M-72	H	H			H	H	H
M-73	H	H			H	H	H
M-74	H	H			H	H	H
M-75	H	H			H	H	H

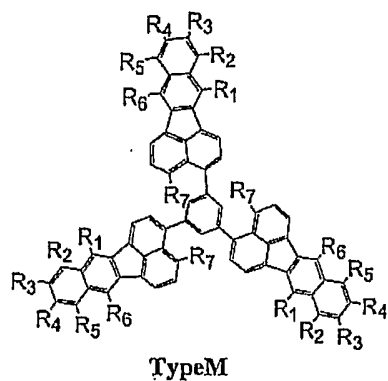

	R ₁	R ₂	R ₃	R ₄	R ₅	R ₆	R ₇
M-76		H	H	H	H		H
M-77		Ph	H	H	Ph		H
M-78		H	Ph	Ph	H		H
M-79		H	Ph	H	H		H
M-80		H	H	H	H		Ph
M-81		Me	H	H	Me		H
M-82		H	Me	Me	H		H
M-83		H	H	H	H		Me
M-84		H	H	H	H		H
M-85		Ph	H	H	Ph		H
M-86		H	Ph	Ph	H		H
M-87		H	Ph	H	H		H
M-88		H	H	H	H		Ph
M-89		Me	H	H	Me		H
M-90		H	Me	Me	H		H
M-91		H	H	H	H		Me
M-92		H	H	H	H		H
M-93		Ph	H	H	Ph		H
M-94		H	Ph	Ph	H		H
M-96		H	Ph	H	H		H
M-96		H	H	H	H		Ph
M-97		Me	H	H	Me		H
M-98		H	Me	Me	H		H
M-99		H	H	H	H		Me

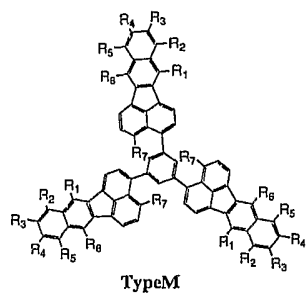

	R ₁	R ₂	R ₃	R ₄	R ₅	R ₆	R ₇
100		H	H	H	H		H
101		Ph	H	H	Ph		H
102		H	Ph	Ph	H		H
103		H	Ph	H	H		H
104		H	H	H	H		Ph
105		Me	H	H	Me		H
106		H	Me	Me	H		H
107		H	H	H	H		Me
108		H	H	H	H		H
109		Ph	H	H	Ph		H
110		H	Ph	Ph	H		H
111		H	Ph	H	H		H
112		H	H	H	H		Ph
113		Me	H	H	Me		H
114		H	Me	Me	H		H
115		H	H	H	H		Me
116		H	H	H	H		H
117		Ph	H	H	Ph		H
118		H	Ph	Ph	H		H
119		H	Ph	H	H		H
120		H	H	H	H		Ph
121		Me	H	H	Me		H
122		H	Me	Me	H		H
123		H	H	H	H		Me

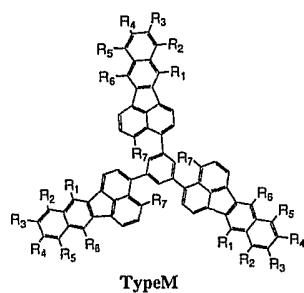

	R ₁	R ₂	R ₃	R ₄	R ₅	R ₆	R ₇
124		H	H	H	H		H
125		Ph	H	H	Ph		H
126		H	Ph	Ph	H		H
127		H	Ph	H	H		H
128		H	H	H	H		Ph
129		Me	H	H	Me		H
130		H	Me	Me	H		H
131		H	H	H	H		Me
132		H	H	H	H		H
133		Ph	H	H	Ph		H
134		H	Ph	Ph	H		H
135		H	Ph	H	H		H
136		H	H	H	H		Ph
137		Me	H	H	Me		H
138		H	Me	Me	H		H
139		H	H	H	H		Me
140		H	H	H	H		H
141		Ph	H	H	Ph		H
142		H	Ph	Ph	H		H
143		H	Ph	H	H		H
144		H	H	H	H		Ph
145		Me	H	H	Me		H
146		H	Me	Me	H		H
147		H	H	H	H		Me

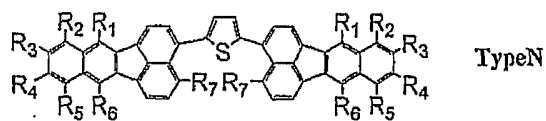

	R ₁	R ₂	R ₃	R ₄	R ₅	R ₆	R ₇
N-1	H	H	H	H	H	H	H
N-2	Ph	H	H	H	H	Ph	H
N-3	Ph	Ph	H	H	Ph	Ph	H
N-4	Ph	H	Ph	Ph	H	Ph	H
N-5	Ph	H	Ph	H	H	Ph	H
N-6	Ph	H	H	H	H	Ph	Ph
N-7	Ph	Me	H	H	Me	Ph	H
N-8	Ph	H	Me	Me	H	Ph	H
N-9	Ph	H	H	H	H	Ph	Me
N-10		H	H	H	H		H
N-11		Ph	H	H	Ph		H
N-12		H	Ph	Ph	H		H
N-13		H	Ph	H	H		H
N-14		H	H	H	H		Ph
N-15		Me	H	H	Me		H
N-16		H	Me	Me	H		H
N-17		H	H	H	H		Me
N-18		H	H	H	H		H
N-19		Ph	H	H	Ph		H
N-20		H	Ph	Ph	H		H
N-21		H	Ph	H	H		H
N-22		H	H	H	H		Ph
N-23		Me	H	H	Me		H
N-24		H	Me	Me	H		H
N-25		H	H	H	H		Me

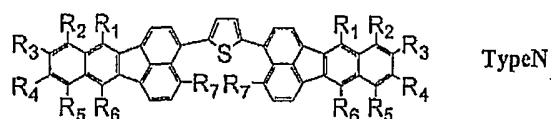

	R ₁	R ₂	R ₃	R ₄	R ₅	R ₆	R ₇
N-26		H	H	H	H		H
N-27		Ph	H	H	Ph		H
N-28		H	Ph	Ph	H		H
N-29		H	Ph	H	H		H
N-30		H	H	H	H		Ph
N-31		Me	H	H	Me		H
N-32		H	Me	Me	H		H
N-33		H	H	H	H		Me
N-34		H	H	H	H		H
N-35		Ph	H	H	Ph		H
N-36		H	Ph	Ph	H		H
N-37		H	Ph	H	H		H
N-38		H	H	H	H		Ph
N-39		Me	H	H	Me		H
N-40		H	Me	Me	H		H
N-41		H	H	H	H		Me
N-42		H	H	H	H		H
N-43		Ph	H	H	Ph		H
N-44		H	Ph	Ph	H		H
N-45		H	Ph	H	H		H
N-46		H	H	H	H		Ph
N-47		Me	H	H	Me		H
N-48		H	Me	Me	H		H
N-49		H	H	H	H		Me

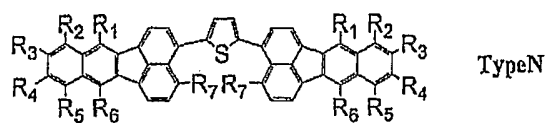

	R ₁	R ₂	R ₃	R ₄	R ₅	R ₆	R ₇
N-50	Ph	H	H	H	H		H
N-51	Ph	H	H	H	H		H
N-52	Ph	H	H	H	H		H
N-53	Ph	H	H	H	H		H
N-54	Ph	H	H	H	H		H
N-55		H	H	H	H		H
N-56		H	H	H	H		H
N-57		H	H	H	H		H
N-58		H	H	H	H		H
N-59		H	H	H	H		H
N-60		H	H	H	H		H
N-61		H	H	H	H		H
N-62		H	H	H	H		H
N-63		H	H	H	H		H
N-64		H	H	H	H		H
N-65	H	Ph	H	H	Ph	H	H
N-66	H		H	H		H	H
N-67	H		H	H		H	H
N-68	H		H	H		H	H
N-69	H		H	H		H	H
N-70	H		H	H		H	H
N-71	H	H			H	H	H
N-72	H	H			H	H	H
N-73	H	H			H	H	H
N-74	H	H			H	H	H
N-75	H	H			H	H	H

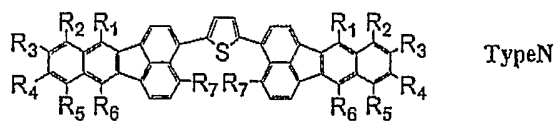

	R ₁	R ₂	R ₃	R ₄	R ₅	R ₆	R ₇
N-76		H	H	H	H		H
N-77		Ph	H	H	Ph		H
N-78		H	Ph	Ph	H		H
N-79		H	Ph	H	H		H
N-80		H	H	H	H		Ph
N-81		Me	H	H	Me		H
N-82		H	Me	Me	H		H
N-83		H	H	H	H		Me
N-84		H	H	H	H		H
N-85		Ph	H	H	Ph		H
N-86		H	Ph	Ph	H		H
N-87		H	Ph	H	H		H
N-88		H	H	H	H		Ph
N-89		Me	H	H	Me		H
N-90		H	Me	Me	H		H
N-91		H	H	H	H		Me
N-92		H	H	H	H		H
N-93		Ph	H	H	Ph		H
N-94		H	Ph	Ph	H		H
N-96		H	Ph	H	H		H
N-96		H	H	H	H		Ph
N-97		Me	H	H	Me		H
N-98		H	Me	Me	H		H
N-99		H	H	H	H		Me

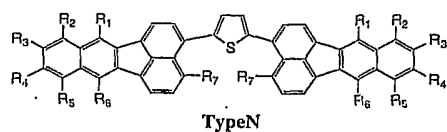

	R ₁	R ₂	R ₃	R ₄	R ₅	R ₆	R ₇
100		H	H	H	H		H
101		Ph	H	H	Ph		H
102		H	Ph	Ph	H		H
103		H	Ph	H	H		H
104		H	H	H	H		Ph
105		Me	H	H	Me		H
106		H	Me	Me	H		H
107		H	H	H	H		Me
108		H	H	H	H		H
109		Ph	H	H	Ph		H
110		H	Ph	Ph	H		H
111		H	Ph	H	H		H
112		H	H	H	H		Ph
113		Me	H	H	Me		H
114		H	Me	Me	H		H
115		H	H	H	H		Me
116		H	H	H	H		H
117		Ph	H	H	Ph		H
118		H	Ph	Ph	H		H
119		H	Ph	H	H		H
120		H	H	H	H		Ph
121		Me	H	H	Me		H
122		H	Me	Me	H		H
123		H	H	H	H		Me

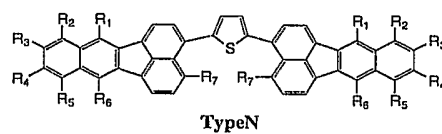

	R ₁	R ₂	R ₃	R ₄	R ₅	R ₆	R ₇
124		H	H	H	H		H
125		Ph	H	H	Ph		H
126		H	Ph	Ph	H		H
127		H	Ph	H	H		H
128		H	H	H	H		Ph
129		Me	H	H	Me		H
130		H	Me	Me	H		H
131		H	H	H	H		Me
132		H	H	H	H		H
133		Ph	H	H	Ph		H
134		H	Ph	Ph	H		H
135		H	Ph	H	H		H
136		H	H	H	H		Ph
137		Me	H	H	Me		H
138		H	Me	Me	H		H
139		H	H	H	H		Me
140		H	H	H	H		H
141		Ph	H	H	Ph		H
142		H	Ph	Ph	H		H
143		H	Ph	H	H		H
144		H	H	H	H		Ph
145		Me	H	H	Me		H
146		H	Me	Me	H		H
147		H	H	H	H		Me

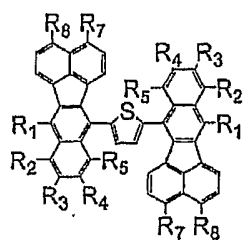

Type O

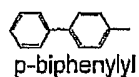
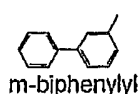
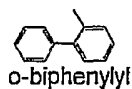
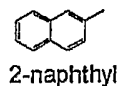
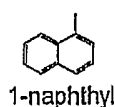

	R ₁	R ₂	R ₃	R ₄	R ₅	R ₇	R ₈
O-1	H	H	H	H	H	H	H
O-2	Ph	H	H	H	H	H	H
O-3	Ph	Ph	H	H	Ph	H	H
O-4	Ph	H	Ph	Ph	H	H	H
O-5	Ph	H	Ph	H	H	H	H
O-6	Ph	H	H	Ph	H	H	H
O-7	Ph	H	H	H	H	Ph	H
O-8	Ph	H	H	H	H	H	Ph
O-9	Ph	H	H	H	H	Ph	Ph
O-10	Ph	H	H	H	H	1-naphthyl	H
O-11	Ph	H	H	H	H	H	1-naphthyl
O-12	Ph	H	H	H	H	1-naphthyl	1-naphthyl
O-13	Ph	H	H	H	H	2-naphthyl	H
O-14	Ph	H	H	H	H	H	2-naphthyl
O-15	Ph	H	H	H	H	2-naphthyl	2-naphthyl
O-16	Ph	H	H	H	H	o-biphenyl	H
O-17	Ph	H	H	H	H	H	o-biphenyl
O-18	Ph	H	H	H	H	o-biphenyl	o-biphenyl
O-19	Ph	H	H	H	H	m-biphenyl	H
O-20	Ph	H	H	H	H	H	m-biphenyl
O-21	Ph	H	H	H	H	m-biphenyl	m-biphenyl
O-22	Ph	H	H	H	H	p-biphenyl	H
O-23	Ph	H	H	H	H	H	p-biphenyl
O-24	Ph	H	H	H	H	p-biphenyl	p-biphenyl
O-25	1-naphthyl	H	H	H	H	H	H
O-26	1-naphthyl	Ph	H	H	Ph	H	H
O-27	1-naphthyl	H	Ph	Ph	H	H	H
O-28	1-naphthyl	H	Ph	H	H	H	H
O-29	1-naphthyl	H	H	Ph	H	H	H
O-30	1-naphthyl	H	H	H	H	Ph	H
O-31	1-naphthyl	H	H	H	H	H	Ph
O-32	1-naphthyl	H	H	H	H	Ph	Ph
O-33	1-naphthyl	H	H	H	H	1-naphthyl	H
O-34	1-naphthyl	H	H	H	H	H	1-naphthyl
O-35	1-naphthyl	H	H	H	H	1-naphthyl	1-naphthyl
O-36	1-naphthyl	H	H	H	H	2-naphthyl	H
O-37	1-naphthyl	H	H	H	H	H	2-naphthyl
O-38	1-naphthyl	H	H	H	H	2-naphthyl	2-naphthyl
O-39	1-naphthyl	H	H	H	H	o-biphenyl	H
O-40	1-naphthyl	H	H	H	H	H	o-biphenyl
O-41	1-naphthyl	H	H	H	H	o-biphenyl	o-biphenyl
O-42	1-naphthyl	H	H	H	H	m-biphenyl	H
O-43	1-naphthyl	H	H	H	H	H	m-biphenyl
O-44	1-naphthyl	H	H	H	H	m-biphenyl	m-biphenyl
O-45	1-naphthyl	H	H	H	H	p-biphenyl	H
O-46	1-naphthyl	H	H	H	H	H	p-biphenyl
O-47	1-naphthyl	H	H	H	H	p-biphenyl	p-biphenyl

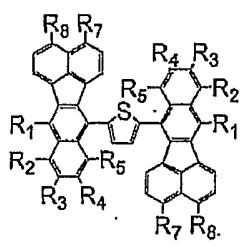
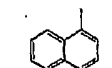
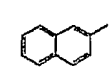
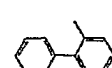
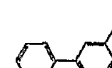
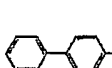
	R ₁	R ₂	R ₃	R ₄	R ₅	R ₇	R ₈
	O-48	2-naphthyl	H	H	H	H	H
	O-49	2-naphthyl	Ph	H	H	Ph	H
	O-50	2-naphthyl	H	Ph	Ph	H	H
	O-51	2-naphthyl	H	Ph	H	H	H
	O-52	2-naphthyl	H	H	Ph	H	H
	O-53	2-naphthyl	H	H	H	Ph	H
	O-54	2-naphthyl	H	H	H	H	Ph
	O-55	2-naphthyl	H	H	H	Ph	Ph
	O-56	2-naphthyl	H	H	H	1-naphthyl	H
	O-57	2-naphthyl	H	H	H	H	1-naphthyl
	O-58	2-naphthyl	H	H	H	1-naphthyl	1-naphthyl
	O-59	2-naphthyl	H	H	H	2-naphthyl	H
	O-60	2-naphthyl	H	H	H	H	2-naphthyl
	O-61	2-naphthyl	H	H	H	2-naphthyl	2-naphthyl
	O-62	2-naphthyl	H	H	H	o-biphenyl	H
	O-63	2-naphthyl	H	H	H	H	o-biphenyl
	O-64	2-naphthyl	H	H	H	o-biphenyl	o-biphenyl
	O-65	2-naphthyl	H	H	H	m-biphenyl	H
	O-66	2-naphthyl	H	H	H	H	m-biphenyl
	O-67	2-naphthyl	H	H	H	m-biphenyl	m-biphenyl
	O-68	2-naphthyl	H	H	H	p-biphenyl	H
	O-69	2-naphthyl	H	H	H	H	p-biphenyl
	O-70	2-naphthyl	H	H	H	p-biphenyl	p-biphenyl
	O-71	o-biphenyl	H	H	H	H	H
	O-72	o-biphenyl	Ph	H	H	Ph	H
	O-73	o-biphenyl	H	Ph	Ph	H	H
	O-74	o-biphenyl	H	Ph	H	H	H
	O-75	o-biphenyl	H	H	Ph	H	H
	O-76	o-biphenyl	H	H	H	Ph	H
	O-77	o-biphenyl	H	H	H	H	Ph
	O-78	o-biphenyl	H	H	H	Ph	Ph
	O-79	o-biphenyl	H	H	H	1-naphthyl	H
	O-80	o-biphenyl	H	H	H	H	1-naphthyl
	O-81	o-biphenyl	H	H	H	1-naphthyl	1-naphthyl
	O-82	o-biphenyl	H	H	H	2-naphthyl	H
	O-83	o-biphenyl	H	H	H	H	2-naphthyl
	O-84	o-biphenyl	H	H	H	2-naphthyl	2-naphthyl
	O-85	o-biphenyl	H	H	H	o-biphenyl	H
	O-86	o-biphenyl	H	H	H	H	o-biphenyl
	O-87	o-biphenyl	H	H	H	o-biphenyl	o-biphenyl
	O-88	o-biphenyl	H	H	H	m-biphenyl	H
	O-89	o-biphenyl	H	H	H	H	m-biphenyl
	O-90	o-biphenyl	H	H	H	m-biphenyl	m-biphenyl
	O-91	o-biphenyl	H	H	H	p-biphenyl	H
	O-92	o-biphenyl	H	H	H	H	p-biphenyl
	O-93	o-biphenyl	H	H	H	p-biphenyl	p-biphenyl

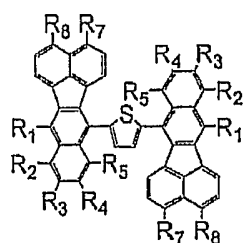

Type O

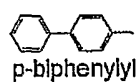
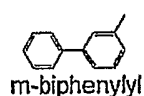
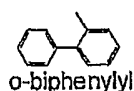
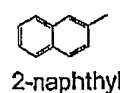
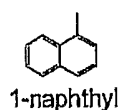

	R ₁	R ₂	R ₃	R ₄	R ₅	R ₇	R ₈
O-94	m-biphenyl	H	H	H	H	H	H
O-95	m-biphenyl	Ph	H	H	Ph	H	H
O-96	m-biphenyl	H	Ph	Ph	H	H	H
O-97	m-biphenyl	H	Ph	H	H	H	H
O-98	m-biphenyl	H	H	Ph	H	H	H
O-99	m-biphenyl	H	H	H	H	Ph	H
O-100	m-biphenyl	H	H	H	H	H	Ph
O-101	m-biphenyl	H	H	H	H	Ph	Ph
O-102	m-biphenyl	H	H	H	H	1-naphthyl	H
O-103	m-biphenyl	H	H	H	H	H	1-naphthyl
O-104	m-biphenyl	H	H	H	H	1-naphthyl	1-naphthyl
O-105	m-biphenyl	H	H	H	H	2-naphthyl	H
O-106	m-biphenyl	H	H	H	H	H	2-naphthyl
O-107	m-biphenyl	H	H	H	H	2-naphthyl	2-naphthyl
O-108	m-biphenyl	H	H	H	H	o-biphenyl	H
O-109	m-biphenyl	H	H	H	H	H	o-biphenyl
O-110	m-biphenyl	H	H	H	H	o-biphenyl	o-biphenyl
O-111	m-biphenyl	H	H	H	H	m-biphenyl	H
O-112	m-biphenyl	H	H	H	H	H	m-biphenyl
O-113	m-biphenyl	H	H	H	H	m-biphenyl	m-biphenyl
O-114	m-biphenyl	H	H	H	H	p-biphenyl	H
O-115	m-biphenyl	H	H	H	H	H	p-biphenyl
O-116	m-biphenyl	H	H	H	H	p-biphenyl	p-biphenyl
O-117	p-biphenyl	H	H	H	H	H	H
O-118	p-biphenyl	Ph	H	H	Ph	H	H
O-119	p-biphenyl	H	Ph	Ph	H	H	H
O-120	p-biphenyl	H	Ph	H	H	H	H
O-121	p-biphenyl	H	H	Ph	H	H	H
O-122	p-biphenyl	H	H	H	H	Ph	H
O-123	p-biphenyl	H	H	H	H	H	Ph
O-124	p-biphenyl	H	H	H	H	Ph	Ph
O-125	p-biphenyl	H	H	H	H	1-naphthyl	H
O-126	p-biphenyl	H	H	H	H	H	1-naphthyl
O-127	p-biphenyl	H	H	H	H	1-naphthyl	1-naphthyl
O-128	p-biphenyl	H	H	H	H	2-naphthyl	H
O-129	p-biphenyl	H	H	H	H	H	2-naphthyl
O-130	p-biphenyl	H	H	H	H	2-naphthyl	2-naphthyl
O-131	p-biphenyl	H	H	H	H	o-biphenyl	H
O-132	p-biphenyl	H	H	H	H	H	o-biphenyl
O-133	p-biphenyl	H	H	H	H	o-biphenyl	o-biphenyl
O-134	p-biphenyl	H	H	H	H	m-biphenyl	H
O-135	p-biphenyl	H	H	H	H	H	m-biphenyl
O-136	p-biphenyl	H	H	H	H	m-biphenyl	m-biphenyl
O-137	p-biphenyl	H	H	H	H	p-biphenyl	H
O-138	p-biphenyl	H	H	H	H	H	p-biphenyl
O-139	p-biphenyl	H	H	H	H	p-biphenyl	p-biphenyl

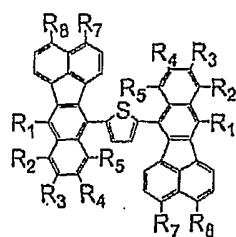

Type O

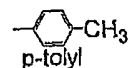
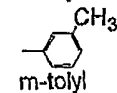
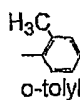
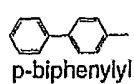
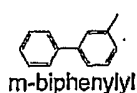
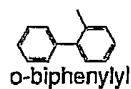
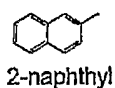
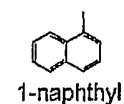

	R ₁	R ₂	R ₃	R ₄	R ₅	R ₇	R ₈
O-140	o-tolyl	H	H	H	H	H	H
O-141	o-tolyl	Ph	H	H	Ph	H	H
O-142	o-tolyl	H	Ph	Ph	H	H	H
O-143	o-tolyl	H	H	H	H	Ph	H
O-144	o-tolyl	H	H	H	H	H	Ph
O-145	o-tolyl	H	H	H	H	1-naphthyl	H
O-146	o-tolyl	H	H	H	H	H	1-naphthyl
O-147	o-tolyl	H	H	H	H	2-naphthyl	H
O-148	o-tolyl	H	H	H	H	H	2-naphthyl
O-149	o-tolyl	H	H	H	H	o-biphenylyl	H
O-150	o-tolyl	H	H	H	H	H	o-biphenylyl
O-151	o-tolyl	H	H	H	H	m-biphenylyl	H
O-152	o-tolyl	H	H	H	H	H	m-biphenylyl
O-153	o-tolyl	H	H	H	H	p-biphenylyl	H
O-154	o-tolyl	H	H	H	H	H	p-biphenylyl
O-155	o-tolyl	H	H	H	H	o-tolyl	H
O-156	o-tolyl	H	H	H	H	H	o-tolyl
O-157	m-tolyl	H	H	H	H	H	H
O-158	m-tolyl	Ph	H	H	Ph	H	H
O-159	m-tolyl	H	Ph	Ph	H	H	H
O-160	m-tolyl	H	H	H	H	Ph	H
O-161	m-tolyl	H	H	H	H	H	Ph
O-162	m-tolyl	H	H	H	H	1-naphthyl	H
O-163	m-tolyl	H	H	H	H	H	1-naphthyl
O-164	m-tolyl	H	H	H	H	2-naphthyl	H
O-165	m-tolyl	H	H	H	H	H	2-naphthyl
O-166	m-tolyl	H	H	H	H	o-biphenylyl	H
O-167	m-tolyl	H	H	H	H	H	o-biphenylyl
O-168	m-tolyl	H	H	H	H	m-biphenylyl	H
O-169	m-tolyl	H	H	H	H	H	m-biphenylyl
O-170	m-tolyl	H	H	H	H	p-biphenylyl	H
O-171	m-tolyl	H	H	H	H	H	p-biphenylyl
O-172	m-tolyl	H	H	H	H	m-tolyl	H
O-173	m-tolyl	H	H	H	H	H	m-tolyl
O-174	p-tolyl	H	H	H	H	H	H
O-175	p-tolyl	Ph	H	H	Ph	H	H
O-176	p-tolyl	H	Ph	Ph	H	H	H
O-177	p-tolyl	H	H	H	H	Ph	H
O-178	p-tolyl	H	H	H	H	H	Ph
O-179	p-tolyl	H	H	H	H	1-naphthyl	H
O-180	p-tolyl	H	H	H	H	H	1-naphthyl
O-181	p-tolyl	H	H	H	H	2-naphthyl	H
O-182	p-tolyl	H	H	H	H	H	2-naphthyl
O-183	p-tolyl	H	H	H	H	o-biphenylyl	H
O-184	p-tolyl	H	H	H	H	H	o-biphenylyl
O-185	p-tolyl	H	H	H	H	m-biphenylyl	H
O-186	p-tolyl	H	H	H	H	H	m-biphenylyl
O-187	p-tolyl	H	H	H	H	p-biphenylyl	H
O-188	p-tolyl	H	H	H	H	H	p-biphenylyl
O-189	p-tolyl	H	H	H	H	p-tolyl	H
O-190	p-tolyl	H	H	H	H	H	p-tolyl

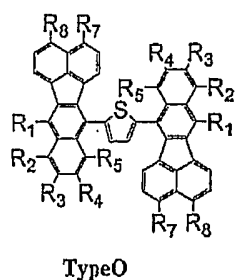

	R ₁	R ₂	R ₃	R ₄	R ₅	R ₇	R ₈
O-191	Ph	H	-CH3	-CH3	H	H	H
O-192	1-naphthyl	H	-CH3	-CH3	H	H	H
O-193	2-naphthyl	H	-CH3	-CH3	H	H	H
O-194	o-biphenyl	H	-CH3	-CH3	H	H	H
O-195	m-biphenyl	H	-CH3	-CH3	H	H	H
O-196	p-biphenyl	H	-CH3	-CH3	H	H	H
O-197	o-tolyl	H	-CH3	-CH3	H	H	H
O-198	m-tolyl	H	-CH3	-CH3	H	H	H
O-199	p-tolyl	H	-CH3	-CH3	H	H	H
O-200	Ph	H	H	H	H	-CH3	H
O-201	1-naphthyl	H	H	H	H	-CH3	H
O-202	2-naphthyl	H	H	H	H	-CH3	H
O-203	o-biphenyl	H	H	H	H	-CH3	H
O-204	m-biphenyl	H	H	H	H	-CH3	H
O-205	p-biphenyl	H	H	H	H	-CH3	H
O-206	o-tolyl	H	H	H	H	-CH3	H
O-207	m-tolyl	H	H	H	H	-CH3	H
O-208	p-tolyl	H	H	H	H	-CH3	H
O-209	Ph	H	H	H	H	H	-CH3
O-210	1-naphthyl	H	H	H	H	H	-CH3
O-211	2-naphthyl	H	H	H	H	H	-CH3
O-212	o-biphenyl	H	H	H	H	H	-CH3
O-213	m-biphenyl	H	H	H	H	H	-CH3
O-214	p-biphenyl	H	H	H	H	H	-CH3
O-215	o-tolyl	H	H	H	H	H	-CH3
O-216	m-tolyl	H	H	H	H	H	-CH3
O-217	p-tolyl	H	H	H	H	H	-CH3
O-218	Ph	H	H	H	H	-CH3	-CH3
O-219	1-naphthyl	H	H	H	H	-CH3	-CH3
O-220	2-naphthyl	H	H	H	H	-CH3	-CH3
O-221	o-biphenyl	H	H	H	H	-CH3	-CH3
O-222	m-biphenyl	H	H	H	H	-CH3	-CH3
O-223	p-biphenyl	H	H	H	H	-CH3	-CH3
O-224	o-tolyl	H	H	H	H	-CH3	-CH3
O-225	m-tolyl	H	H	H	H	-CH3	-CH3
O-226	p-tolyl	H	H	H	H	-CH3	-CH3
O-227	Ph	H	H	H	H	H	DPA
O-228	1-naphthyl	H	H	H	H	H	DPA
O-229	2-naphthyl	H	H	H	H	H	DPA
O-230	o-biphenyl	H	H	H	H	H	DPA
O-231	m-biphenyl	H	H	H	H	H	DPA
O-232	p-biphenyl	H	H	H	H	H	DPA
O-233	Ph	H	H	H	H	DPA	H
O-234	1-naphthyl	H	H	H	H	DPA	H
O-235	2-naphthyl	H	H	H	H	DPA	H
O-236	o-biphenyl	H	H	H	H	DPA	H
O-237	m-biphenyl	H	H	H	H	DPA	H
O-238	p-biphenyl	H	H	H	H	DPA	H
O-239	Ph	H	H	H	H	H	TPA
O-240	1-naphthyl	H	H	H	H	H	TPA
O-241	2-naphthyl	H	H	H	H	H	TPA
O-242	o-biphenyl	H	H	H	H	H	TPA
O-243	m-biphenyl	H	H	H	H	H	TPA
O-244	p-biphenyl	H	H	H	H	H	TPA
O-245	Ph	H	H	H	H	TPA	H
O-246	1-naphthyl	H	H	H	H	TPA	H
O-247	2-naphthyl	H	H	H	H	TPA	H
O-248	o-biphenyl	H	H	H	H	TPA	H
O-249	m-biphenyl	H	H	H	H	TPA	H
O-250	p-biphenyl	H	H	H	H	TPA	H

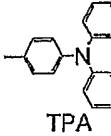
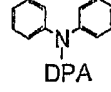
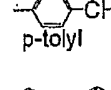
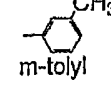
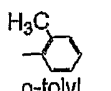
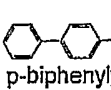
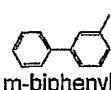
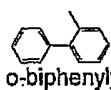
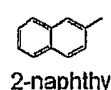
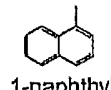

	R ₁	R ₂	R ₃	R ₅	R ₆	R ₇	R ₈
P-1	H	H	H	H	H	H	H
P-2	Ph	H	H	H	Ph	H	H
P-3	Ph	Ph	H	H	Ph	H	H
P-4	Ph	H	H	Ph	Ph	H	H
P-5	Ph	Ph	H	Ph	Ph	H	H
P-6	Ph	H	Ph	H	Ph	H	H
P-7	Ph	H	H	H	Ph	Ph	H
P-8	Ph	H	H	H	Ph	H	Ph
P-9	Ph	H	H	H	Ph	Ph	Ph
P-10	Ph	H	H	H	Ph	1-naphthyl	H
P-11	Ph	H	H	H	Ph	H	1-naphthyl
P-12	Ph	H	H	H	Ph	1-naphthyl	1-naphthyl
P-13	Ph	H	H	H	Ph	2-naphthyl	H
P-14	Ph	H	H	H	Ph	H	2-naphthyl
P-15	Ph	H	H	H	Ph	2-naphthyl	2-naphthyl
P-16	Ph	H	H	H	Ph	o-biphenyl	H
P-17	Ph	H	H	H	Ph	H	o-biphenyl
P-18	Ph	H	H	H	Ph	o-biphenyl	o-biphenyl
P-19	Ph	H	H	H	Ph	m-biphenyl	H
P-20	Ph	H	H	H	Ph	H	m-biphenyl
P-21	Ph	H	H	H	Ph	m-biphenyl	m-biphenyl
P-22	Ph	H	H	H	Ph	p-biphenyl	H
P-23	Ph	H	H	H	Ph	H	p-biphenyl
P-24	Ph	H	H	H	Ph	p-biphenyl	p-biphenyl
P-25	1-naphthyl	H	H	H	1-naphthyl	H	H
P-26	1-naphthyl	Ph	H	H	1-naphthyl	H	H
P-27	1-naphthyl	H	H	Ph	1-naphthyl	H	H
P-28	1-naphthyl	Ph	H	Ph	1-naphthyl	H	H
P-29	1-naphthyl	H	Ph	H	1-naphthyl	H	H
P-30	1-naphthyl	H	H	H	1-naphthyl	Ph	H
P-31	1-naphthyl	H	H	H	1-naphthyl	H	Ph
P-32	1-naphthyl	H	H	H	1-naphthyl	Ph	Ph
P-33	1-naphthyl	H	H	H	1-naphthyl	1-naphthyl	H
P-34	1-naphthyl	H	H	H	1-naphthyl	H	1-naphthyl
P-35	1-naphthyl	H	H	H	1-naphthyl	1-naphthyl	1-naphthyl
P-36	1-naphthyl	H	H	H	1-naphthyl	2-naphthyl	H
P-37	1-naphthyl	H	H	H	1-naphthyl	H	2-naphthyl
P-38	1-naphthyl	H	H	H	1-naphthyl	2-naphthyl	2-naphthyl
P-39	1-naphthyl	H	H	H	1-naphthyl	o-biphenyl	H
P-40	1-naphthyl	H	H	H	1-naphthyl	H	o-biphenyl
P-41	1-naphthyl	H	H	H	1-naphthyl	o-biphenyl	o-biphenyl
P-42	1-naphthyl	H	H	H	1-naphthyl	m-biphenyl	H
P-43	1-naphthyl	H	H	H	1-naphthyl	H	m-biphenyl
P-44	1-naphthyl	H	H	H	1-naphthyl	m-biphenyl	m-biphenyl
P-45	1-naphthyl	H	H	H	1-naphthyl	p-biphenyl	H
P-46	1-naphthyl	H	H	H	1-naphthyl	H	p-biphenyl
P-47	1-naphthyl	H	H	H	1-naphthyl	p-biphenyl	p-biphenyl

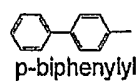
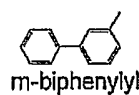
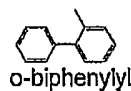
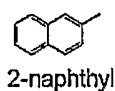
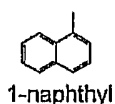
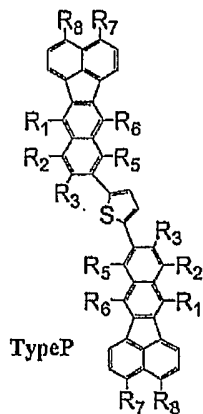

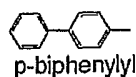
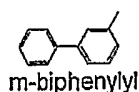
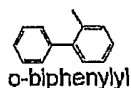
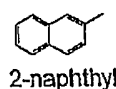
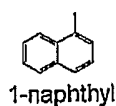
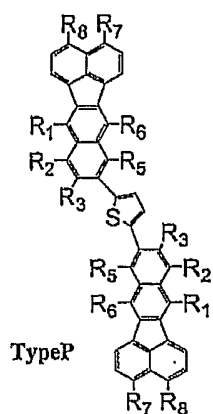

	R ₁	R ₂	R ₃	R ₅	R ₆	R ₇	R ₈
P-48	2-naphthyl	H	H	H	2-naphthyl	H	H
P-49	2-naphthyl	Ph	H	H	2-naphthyl	H	H
P-50	2-naphthyl	H	H	Ph	2-naphthyl	H	H
P-51	2-naphthyl	Ph	H	Ph	2-naphthyl	H	H
P-52	2-naphthyl	H	Ph	H	2-naphthyl	H	H
P-53	2-naphthyl	H	H	H	2-naphthyl	Ph	H
P-54	2-naphthyl	H	H	H	2-naphthyl	H	Ph
P-55	2-naphthyl	H	H	H	2-naphthyl	Ph	Ph
P-56	2-naphthyl	H	H	H	2-naphthyl	1-naphthyl	H
P-57	2-naphthyl	H	H	H	2-naphthyl	H	1-naphthyl
P-58	2-naphthyl	H	H	H	2-naphthyl	1-naphthyl	1-naphthyl
P-59	2-naphthyl	H	H	H	2-naphthyl	2-naphthyl	H
P-60	2-naphthyl	H	H	H	2-naphthyl	H	2-naphthyl
P-61	2-naphthyl	H	H	H	2-naphthyl	2-naphthyl	2-naphthyl
P-62	2-naphthyl	H	H	H	2-naphthyl	o-biphenylyl	H
P-63	2-naphthyl	H	H	H	2-naphthyl	H	o-biphenylyl
P-64	2-naphthyl	H	H	H	2-naphthyl	o-biphenylyl	o-biphenylyl
P-65	2-naphthyl	H	H	H	2-naphthyl	m-biphenylyl	H
P-66	2-naphthyl	H	H	H	2-naphthyl	H	m-biphenylyl
P-67	2-naphthyl	H	H	H	2-naphthyl	m-biphenylyl	m-biphenylyl
P-68	2-naphthyl	H	H	H	2-naphthyl	p-biphenylyl	H
P-69	2-naphthyl	H	H	H	2-naphthyl	H	p-biphenylyl
P-70	2-naphthyl	H	H	H	2-naphthyl	p-biphenylyl	p-biphenylyl
P-71	o-biphenylyl	H	H	H	o-biphenylyl	H	H
P-72	o-biphenylyl	Ph	H	H	o-biphenylyl	H	H
P-73	o-biphenylyl	H	H	Ph	o-biphenylyl	H	H
P-74	o-biphenylyl	Ph	H	Ph	o-biphenylyl	H	H
P-75	o-biphenylyl	H	Ph	H	o-biphenylyl	H	H
P-76	o-biphenylyl	H	H	H	o-biphenylyl	Ph	H
P-77	o-biphenylyl	H	H	H	o-biphenylyl	H	Ph
P-78	o-biphenylyl	H	H	H	o-biphenylyl	Ph	Ph
P-79	o-biphenylyl	H	H	H	o-biphenylyl	1-naphthyl	H
P-80	o-biphenylyl	H	H	H	o-biphenylyl	H	1-naphthyl
P-81	o-biphenylyl	H	H	H	o-biphenylyl	1-naphthyl	1-naphthyl
P-82	o-biphenylyl	H	H	H	o-biphenylyl	2-naphthyl	H
P-83	o-biphenylyl	H	H	H	o-biphenylyl	H	2-naphthyl
P-84	o-biphenylyl	H	H	H	o-biphenylyl	2-naphthyl	2-naphthyl
P-85	o-biphenylyl	H	H	H	o-biphenylyl	o-biphenylyl	H
P-86	o-biphenylyl	H	H	H	o-biphenylyl	H	o-biphenylyl
P-87	o-biphenylyl	H	H	H	o-biphenylyl	o-biphenylyl	o-biphenylyl
P-88	o-biphenylyl	H	H	H	o-biphenylyl	m-biphenylyl	H
P-89	o-biphenylyl	H	H	H	o-biphenylyl	H	m-biphenylyl
P-90	o-biphenylyl	H	H	H	o-biphenylyl	m-biphenylyl	m-biphenylyl
P-91	o-biphenylyl	H	H	H	o-biphenylyl	p-biphenylyl	H
P-92	o-biphenylyl	H	H	H	o-biphenylyl	H	p-biphenylyl
P-93	o-biphenylyl	H	H	H	o-biphenylyl	p-biphenylyl	p-biphenylyl

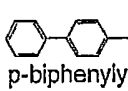
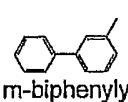
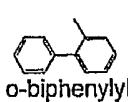
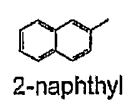
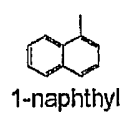
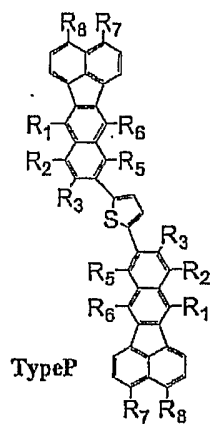

	R ₁	R ₂	R ₃	R ₅	R ₆	R ₇	R ₈
P-94	m-biphenylyl	H	H	H	m-biphenylyl	H	H
P-95	m-biphenylyl	Ph	H	H	m-biphenylyl	H	H
P-96	m-biphenylyl	H	H	Ph	m-biphenylyl	H	H
P-97	m-biphenylyl	Ph	H	Ph	m-biphenylyl	H	H
P-98	m-biphenylyl	H	Ph	H	m-biphenylyl	H	H
P-99	m-biphenylyl	H	H	H	m-biphenylyl	Ph	H
P-100	m-biphenylyl	H	H	H	m-biphenylyl	H	Ph
P-101	m-biphenylyl	H	H	H	m-biphenylyl	Ph	Ph
P-102	m-biphenylyl	H	H	H	m-biphenylyl	1-naphthyl	H
P-103	m-biphenylyl	H	H	H	m-biphenylyl	H	1-naphthyl
P-104	m-biphenylyl	H	H	H	m-biphenylyl	1-naphthyl	1-naphthyl
P-105	m-biphenylyl	H	H	H	m-biphenylyl	2-naphthyl	H
P-106	m-biphenylyl	H	H	H	m-biphenylyl	H	2-naphthyl
P-107	m-biphenylyl	H	H	H	m-biphenylyl	2-naphthyl	2-naphthyl
P-108	m-biphenylyl	H	H	H	m-biphenylyl	o-biphenylyl	H
P-109	m-biphenylyl	H	H	H	m-biphenylyl	H	o-biphenylyl
P-110	m-biphenylyl	H	H	H	m-biphenylyl	o-biphenylyl	o-biphenylyl
P-111	m-biphenylyl	H	H	H	m-biphenylyl	m-biphenylyl	H
P-112	m-biphenylyl	H	H	H	m-biphenylyl	H	m-biphenylyl
P-113	m-biphenylyl	H	H	H	m-biphenylyl	m-biphenylyl	m-biphenylyl
P-114	m-biphenylyl	H	H	H	m-biphenylyl	p-biphenylyl	H
P-115	m-biphenylyl	H	H	H	m-biphenylyl	H	p-biphenylyl
P-116	m-biphenylyl	H	H	H	m-biphenylyl	p-biphenylyl	p-biphenylyl
P-117	p-biphenylyl	H	H	H	p-biphenylyl	H	H
P-118	p-biphenylyl	Ph	H	H	p-biphenylyl	H	H
P-119	p-biphenylyl	H	H	Ph	p-biphenylyl	H	H
P-120	p-biphenylyl	Ph	H	Ph	p-biphenylyl	H	H
P-121	p-biphenylyl	H	Ph	H	p-biphenylyl	H	H
P-122	p-biphenylyl	H	H	H	p-biphenylyl	Ph	H
P-123	p-biphenylyl	H	H	H	p-biphenylyl	H	Ph
P-124	p-biphenylyl	H	H	H	p-biphenylyl	Ph	Ph
P-125	p-biphenylyl	H	H	H	p-biphenylyl	1-naphthyl	H
P-126	p-biphenylyl	H	H	H	p-biphenylyl	H	1-naphthyl
P-127	p-biphenylyl	H	H	H	p-biphenylyl	1-naphthyl	1-naphthyl
P-128	p-biphenylyl	H	H	H	p-biphenylyl	2-naphthyl	H
P-129	p-biphenylyl	H	H	H	p-biphenylyl	H	2-naphthyl
P-130	p-biphenylyl	H	H	H	p-biphenylyl	2-naphthyl	2-naphthyl
P-131	p-biphenylyl	H	H	H	p-biphenylyl	o-biphenylyl	H
P-132	p-biphenylyl	H	H	H	p-biphenylyl	H	o-biphenylyl
P-133	p-biphenylyl	H	H	H	p-biphenylyl	o-biphenylyl	o-biphenylyl
P-134	p-biphenylyl	H	H	H	p-biphenylyl	m-biphenylyl	H
P-135	p-biphenylyl	H	H	H	p-biphenylyl	H	m-biphenylyl
P-136	p-biphenylyl	H	H	H	p-biphenylyl	m-biphenylyl	m-biphenylyl
P-137	p-biphenylyl	H	H	H	p-biphenylyl	p-biphenylyl	H
P-138	p-biphenylyl	H	H	H	p-biphenylyl	H	p-biphenylyl
P-139	p-biphenylyl	H	H	H	p-biphenylyl	p-biphenylyl	p-biphenylyl

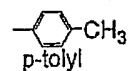
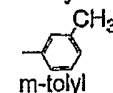
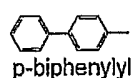
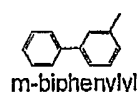
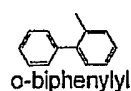
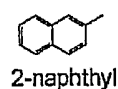
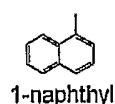
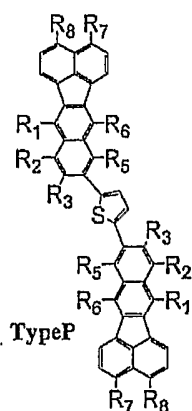

	R ₁	R ₂	R ₃	R ₅	R ₆	R ₇	R ₈
P-140	o-tolyl	H	H	H	o-tolyl	H	H
P-141	o-tolyl	Ph	H	Ph	o-tolyl	H	H
P-142	o-tolyl	H	Ph	H	o-tolyl	H	H
P-143	o-tolyl	H	H	H	o-tolyl	Ph	H
P-144	o-tolyl	H	H	H	o-tolyl	H	Ph
P-145	o-tolyl	H	H	H	o-tolyl	1-naphthyl	H
P-146	o-tolyl	H	H	H	o-tolyl	H	1-naphthyl
P-147	o-tolyl	H	H	H	o-tolyl	2-naphthyl	H
P-148	o-tolyl	H	H	H	o-tolyl	H	2-naphthyl
P-149	o-tolyl	H	H	H	o-tolyl	o-biphenylyl	H
P-150	o-tolyl	H	H	H	o-tolyl	H	o-biphenylyl
P-151	o-tolyl	H	H	H	o-tolyl	m-biphenylyl	H
P-152	o-tolyl	H	H	H	o-tolyl	H	m-biphenylyl
P-153	o-tolyl	H	H	H	o-tolyl	p-biphenylyl	H
P-154	o-tolyl	H	H	H	o-tolyl	H	p-biphenylyl
P-155	o-tolyl	H	H	H	o-tolyl	o-tolyl	H
P-156	o-tolyl	H	H	H	o-tolyl	H	o-tolyl
P-157	m-tolyl	H	H	H	m-tolyl	H	H
P-158	m-tolyl	Ph	H	Ph	m-tolyl	H	H
P-159	m-tolyl	H	Ph	H	m-tolyl	H	H
P-160	m-tolyl	H	H	H	m-tolyl	Ph	H
P-161	m-tolyl	H	H	H	m-tolyl	H	Ph
P-162	m-tolyl	H	H	H	m-tolyl	1-naphthyl	H
P-163	m-tolyl	H	H	H	m-tolyl	H	1-naphthyl
P-164	m-tolyl	H	H	H	m-tolyl	2-naphthyl	H
P-165	m-tolyl	H	H	H	m-tolyl	H	2-naphthyl
P-166	m-tolyl	H	H	H	m-tolyl	o-biphenylyl	H
P-167	m-tolyl	H	H	H	m-tolyl	H	o-biphenylyl
P-168	m-tolyl	H	H	H	m-tolyl	m-biphenylyl	H
P-169	m-tolyl	H	H	H	m-tolyl	H	m-biphenylyl
P-170	m-tolyl	H	H	H	m-tolyl	p-biphenylyl	H
P-171	m-tolyl	H	H	H	m-tolyl	H	p-biphenylyl
P-172	m-tolyl	H	H	H	m-tolyl	m-tolyl	H
P-173	m-tolyl	H	H	H	m-tolyl	H	m-tolyl
P-174	p-tolyl	H	H	H	p-tolyl	H	H
P-175	p-tolyl	Ph	H	Ph	p-tolyl	H	H
P-176	p-tolyl	H	Ph	H	p-tolyl	H	H
P-177	p-tolyl	H	H	H	p-tolyl	Ph	H
P-178	p-tolyl	H	H	H	p-tolyl	H	Ph
P-179	p-tolyl	H	H	H	p-tolyl	1-naphthyl	H
P-180	p-tolyl	H	H	H	p-tolyl	H	1-naphthyl
P-181	p-tolyl	H	H	H	p-tolyl	2-naphthyl	H
P-182	p-tolyl	H	H	H	p-tolyl	H	2-naphthyl
P-183	p-tolyl	H	H	H	p-tolyl	o-biphenylyl	H
P-184	p-tolyl	H	H	H	p-tolyl	H	o-biphenylyl
P-185	p-tolyl	H	H	H	p-tolyl	m-biphenylyl	H
P-186	p-tolyl	H	H	H	p-tolyl	H	m-biphenylyl
P-187	p-tolyl	H	H	H	p-tolyl	p-biphenylyl	H
P-188	p-tolyl	H	H	H	p-tolyl	H	p-biphenylyl
P-189	p-tolyl	H	H	H	p-tolyl	p-tolyl	H
P-190	p-tolyl	H	H	H	p-tolyl	H	p-tolyl

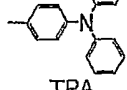
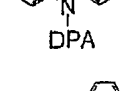
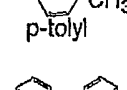
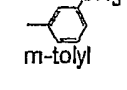
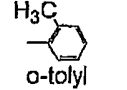
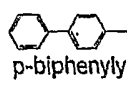
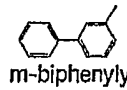
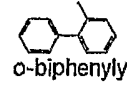
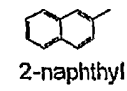
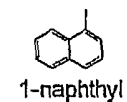
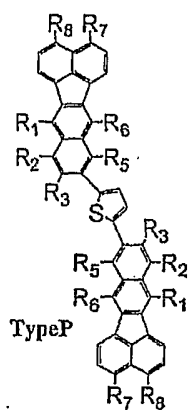

	R ₁	R ₂	R ₃	R ₅	R ₆	R ₇	R ₈
P-191	Ph	H	-CH3	H	Ph	H	H
P-192	1-naphthyl	H	-CH3	H	1-naphthyl	H	H
P-193	2-naphthyl	H	-CH3	H	2-naphthyl	H	H
P-194	o-biphenylyl	H	-CH3	H	o-biphenylyl	H	H
P-195	m-biphenylyl	H	-CH3	H	m-biphenylyl	H	H
P-196	p-biphenylyl	H	-CH3	H	p-biphenylyl	H	H
P-197	o-tolyl	H	-CH3	H	o-tolyl	H	H
P-198	m-tolyl	H	-CH3	H	m-tolyl	H	H
P-199	p-tolyl	H	-CH3	H	p-tolyl	H	H
P-200	Ph	H	H	H	Ph	-CH3	H
P-201	1-naphthyl	H	H	H	1-naphthyl	-CH3	H
P-202	2-naphthyl	H	H	H	2-naphthyl	-CH3	H
P-203	o-biphenylyl	H	H	H	o-biphenylyl	-CH3	H
P-204	m-biphenylyl	H	H	H	m-biphenylyl	-CH3	H
P-205	p-biphenylyl	H	H	H	p-biphenylyl	-CH3	H
P-206	o-tolyl	H	H	H	o-tolyl	-CH3	H
P-207	m-tolyl	H	H	H	m-tolyl	-CH3	H
P-208	p-tolyl	H	H	H	p-tolyl	-CH3	H
P-209	Ph	H	H	H	Ph	H	-CH3
P-210	1-naphthyl	H	H	H	1-naphthyl	H	-CH3
P-211	2-naphthyl	H	H	H	2-naphthyl	H	-CH3
P-212	o-biphenylyl	H	H	H	o-biphenylyl	H	-CH3
P-213	m-biphenylyl	H	H	H	m-biphenylyl	H	-CH3
P-214	p-biphenylyl	H	H	H	p-biphenylyl	H	-CH3
P-215	o-tolyl	H	H	H	o-tolyl	H	-CH3
P-216	m-tolyl	H	H	H	m-tolyl	H	-CH3
P-217	p-tolyl	H	H	H	p-tolyl	H	-CH3
P-218	Ph	H	H	H	Ph	-CH3	-CH3
P-219	1-naphthyl	H	H	H	1-naphthyl	-CH3	-CH3
P-220	2-naphthyl	H	H	H	2-naphthyl	-CH3	-CH3
P-221	o-biphenylyl	H	H	H	o-biphenylyl	-CH3	-CH3
P-222	m-biphenylyl	H	H	H	m-biphenylyl	-CH3	-CH3
P-223	p-biphenylyl	H	H	H	p-biphenylyl	-CH3	-CH3
P-224	o-tolyl	H	H	H	o-tolyl	-CH3	-CH3
P-225	m-tolyl	H	H	H	m-tolyl	-CH3	-CH3
P-226	p-tolyl	H	H	H	p-tolyl	-CH3	-CH3
P-227	Ph	H	H	H	Ph	H	DPA
P-228	1-naphthyl	H	H	H	1-naphthyl	H	DPA
P-229	2-naphthyl	H	H	H	2-naphthyl	H	DPA
P-230	o-biphenylyl	H	H	H	o-biphenylyl	H	DPA
P-231	m-biphenylyl	H	H	H	m-biphenylyl	H	DPA
P-232	p-biphenylyl	H	H	H	p-biphenylyl	H	DPA
P-233	Ph	H	H	H	Ph	DPA	H
P-234	1-naphthyl	H	H	H	1-naphthyl	DPA	H
P-235	2-naphthyl	H	H	H	2-naphthyl	DPA	H
P-236	o-biphenylyl	H	H	H	o-biphenylyl	DPA	H
P-237	m-biphenylyl	H	H	H	m-biphenylyl	DPA	H
P-238	p-biphenylyl	H	H	H	p-biphenylyl	DPA	H
P-239	Ph	H	H	H	Ph	H	TPA
P-240	1-naphthyl	H	H	H	1-naphthyl	H	TPA
P-241	2-naphthyl	H	H	H	2-naphthyl	H	TPA
P-242	o-biphenylyl	H	H	H	o-biphenylyl	H	TPA
P-243	m-biphenylyl	H	H	H	m-biphenylyl	H	TPA
P-244	p-biphenylyl	H	H	H	p-biphenylyl	H	TPA
P-245	Ph	H	H	H	Ph	TPA	H
P-246	1-naphthyl	H	H	H	1-naphthyl	TPA	H
P-247	2-naphthyl	H	H	H	2-naphthyl	TPA	H
P-248	o-biphenylyl	H	H	H	o-biphenylyl	TPA	H
P-249	m-biphenylyl	H	H	H	m-biphenylyl	TPA	H
P-250	p-biphenylyl	H	H	H	p-biphenylyl	TPA	H

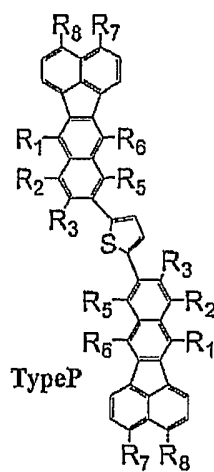
	R ₁	R ₂	R ₃	R ₅	R ₆	R ₇	R ₈
 <p>TypeP</p>	P-251	Ph	H	H	H	1-naphthyl	H
	P-252	Ph	H	H	H	2-naphthyl	H
	P-253	Ph	H	H	H	o-biphenyl	H
	P-254	Ph	H	H	H	m-biphenyl	H
	P-255	Ph	H	H	H	p-biphenyl	H
	P-256	Ph	H	H	H	O-tolyl	H
	P-257	Ph	H	H	H	m-tolyl	H
	P-258	Ph	H	H	H	p-tolyl	H
	P-259	1-naphthyl	H	H	H	2-naphthyl	H
	P-260	1-naphthyl	H	H	H	o-biphenyl	H
P-261	1-naphthyl	H	H	H	m-biphenyl	H	
P-262	1-naphthyl	H	H	H	p-biphenyl	H	
P-263	1-naphthyl	H	H	H	O-tolyl	H	
P-264	1-naphthyl	H	H	H	m-tolyl	H	
P-265	1-naphthyl	H	H	H	p-tolyl	H	
P-266	2-naphthyl	H	H	H	o-biphenyl	H	
P-267	2-naphthyl	H	H	H	m-biphenyl	H	
P-268	2-naphthyl	H	H	H	p-biphenyl	H	
P-269	2-naphthyl	H	H	H	O-tolyl	H	
P-270	2-naphthyl	H	H	H	m-tolyl	H	
P-271	2-naphthyl	H	H	H	p-tolyl	H	
P-272	o-biphenyl	H	H	H	m-biphenyl	H	
P-273	o-biphenyl	H	H	H	p-biphenyl	H	
P-274	o-biphenyl	H	H	H	O-tolyl	H	
P-275	o-biphenyl	H	H	H	m-tolyl	H	
P-276	o-biphenyl	H	H	H	p-tolyl	H	
P-277	m-biphenyl	H	H	H	p-biphenyl	H	
P-278	m-biphenyl	H	H	H	O-tolyl	H	
P-279	m-biphenyl	H	H	H	m-tolyl	H	
P-280	m-biphenyl	H	H	H	p-tolyl	H	
P-281	p-biphenyl	H	H	H	O-tolyl	H	
P-282	p-biphenyl	H	H	H	m-tolyl	H	
P-283	p-biphenyl	H	H	H	p-tolyl	H	
P-284	O-tolyl	H	H	H	m-tolyl	H	
P-285	O-tolyl	H	H	H	p-tolyl	H	
P-286	m-tolyl	H	H	H	p-tolyl	H	

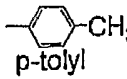
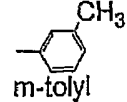
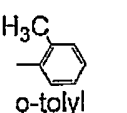
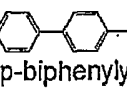
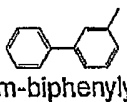
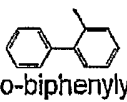
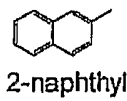
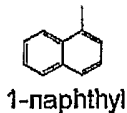

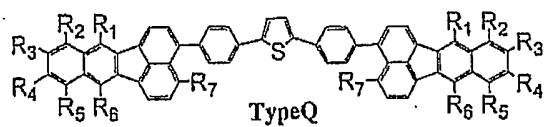

	R ₁	R ₂	R ₃	R ₄	R ₅	R ₆	R ₇
Q-1	H	H	H	H	H	H	H
Q-2	Ph	H	H	H	H	Ph	H
Q-3	Ph	Ph	H	H	Ph	Ph	H
Q-4	Ph	H	Ph	Ph	H	Ph	H
Q-5	Ph	H	Ph	H	H	Ph	H
Q-6	Ph	H	H	H	H	Ph	Ph
Q-7	Ph	Me	H	H	Me	Ph	H
Q-8	Ph	H	Me	Me	H	Ph	H
Q-9	Ph	H	H	H	H	Ph	Me
Q-10		H	H	H	H		H
Q-11		Ph	H	H	Ph		H
Q-12		H	Ph	Ph	H		H
Q-13		H	Ph	H	H		H
Q-14		H	H	H	H		Ph
Q-15		Me	H	H	Me		H
Q-16		H	Me	Me	H		H
Q-17		H	H	H	H		Me
Q-18		H	H	H	H		H
Q-19		Ph	H	H	Ph		H
Q-20		H	Ph	Ph	H		H
Q-21		H	Ph	H	H		H
Q-22		H	H	H	H		Ph
Q-23		Me	H	H	Me		H
Q-24		H	Me	Me	H		H
Q-25		H	H	H	H		Me

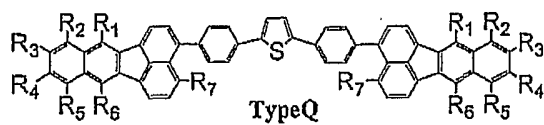

	R ₁	R ₂	R ₃	R ₄	R ₅	R ₆	R ₇
Q-26		H	H	H	H		H
Q-27		Ph	H	H	Ph		H
Q-28		H	Ph	Ph	H		H
Q-29		H	Ph	H	H		H
Q-30		H	H	H	H		Ph
Q-31		Me	H	H	Me		H
Q-32		H	Me	Me	H		H
Q-33		H	H	H	H		Me
Q-34		H	H	H	H		H
Q-35		Ph	H	H	Ph		H
Q-36		H	Ph	Ph	H		H
Q-37		H	Ph	H	H		H
Q-38		H	H	H	H		Ph
Q-39		Me	H	H	Me		H
Q-40		H	Me	Me	H		H
Q-41		H	H	H	H		Me
Q-42		H	H	H	H		H
Q-43		Ph	H	H	Ph		H
Q-44		H	Ph	Ph	H		H
Q-45		H	Ph	H	H		H
Q-46		H	H	H	H		Ph
Q-47		Me	H	H	Me		H
Q-48		H	Me	Me	H		H
Q-49		H	H	H	H		Me

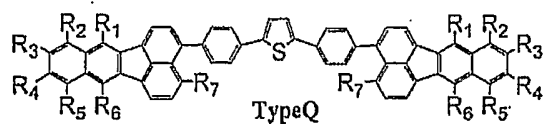

	R ₁	R ₂	R ₃	R ₄	R ₅	R ₆	R ₇
Q-50	Ph	H	H	H	H		H
Q-51	Ph	H	H	H	H		H
Q-52	Ph	H	H	H	H		H
Q-53	Ph	H	H	H	H		H
Q-54	Ph	H	H	H	H		H
Q-55		H	H	H	H		H
Q-56		H	H	H	H		H
Q-57		H	H	H	H		H
Q-58		H	H	H	H		H
Q-59		H	H	H	H		H
Q-60		H	H	H	H		H
Q-61		H	H	H	H		H
Q-62		H	H	H	H		H
Q-63		H	H	H	H		H
Q-64		H	H	H	H		H
Q-65	H	Ph	H	H	Ph	H	H
Q-66	H		H	H		H	H
Q-67	H		H	H		H	H
Q-68	H		H	H		H	H
Q-69	H		H	H		H	H
Q-70	H		H	H		H	H
Q-71	H	H			H	H	H
Q-72	H	H			H	H	H
Q-73	H	H			H	H	H
Q-74	H	H			H	H	H
Q-75	H	H			H	H	H

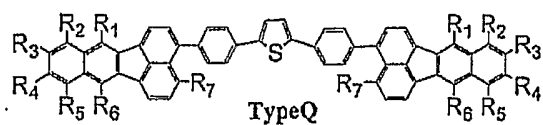

	R ₁	R ₂	R ₃	R ₄	R ₅	R ₆	R ₇
Q-76		H	H	H	H		H
Q-77		Ph	H	H	Ph		H
Q-78		H	Ph	Ph	H		H
Q-79		H	Ph	H	H		H
Q-80		H	H	H	H		Ph
Q-81		Me	H	H	Me		H
Q-82		H	Me	Me	H		H
Q-83		H	H	H	H		Me
Q-84		H	H	H	H		H
Q-85		Ph	H	H	Ph		H
Q-86		H	Ph	Ph	H		H
Q-87		H	Ph	H	H		H
Q-88		H	H	H	H		Ph
Q-89		Me	H	H	Me		H
Q-90		H	Me	Me	H		H
Q-91		H	H	H	H		Me
Q-92		H	H	H	H		H
Q-93		Ph	H	H	Ph		H
Q-94		H	Ph	Ph	H		H
Q-96		H	Ph	H	H		H
Q-96		H	H	H	H		Ph
Q-97		Me	H	H	Me		H
Q-98		H	Me	Me	H		H
Q-99		H	H	H	H		Me

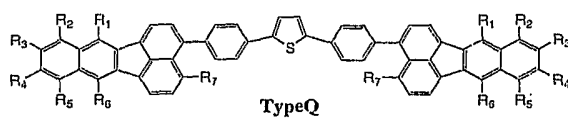

	R ₁	R ₂	R ₃	R ₄	R ₅	R ₆	R ₇
100		H	H	H	H		H
101		Ph	H	H	Ph		H
102		H	Ph	Ph	H		H
103		H	Ph	H	H		H
104		H	H	H	H		Ph
105		Me	H	H	Me		H
106		H	Me	Me	H		H
107		H	H	H	H		Me
108		H	H	H	H		H
109		Ph	H	H	Ph		H
110		H	Ph	Ph	H		H
111		H	Ph	H	H		H
112		H	H	H	H		Ph
113		Me	H	H	Me		H
114		H	Me	Me	H		H
115		H	H	H	H		Me
116		H	H	H	H		H
117		Ph	H	H	Ph		H
118		H	Ph	Ph	H		H
119		H	Ph	H	H		H
120		H	H	H	H		Ph
121		Me	H	H	Me		H
122		H	Me	Me	H		H
123		H	H	H	H		Me

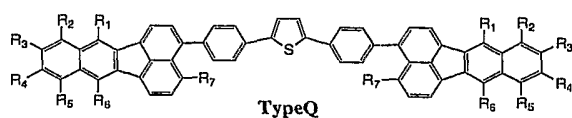

	R ₁	R ₂	R ₃	R ₄	R ₅	R ₆	R ₇
124		H	H	H	H		H
125		Ph	H	H	Ph		H
126		H	Ph	Ph	H		H
127		H	Ph	H	H		H
128		H	H	H	H		Ph
129		Me	H	H	Me		H
130		H	Me	Me	H		H
131		H	H	H	H		Me
132		H	H	H	H		H
133		Ph	H	H	Ph		H
134		H	Ph	Ph	H		H
135		H	Ph	H	H		H
136		H	H	H	H		Ph
137		Me	H	H	Me		H
138		H	Me	Me	H		H
139		H	H	H	H		Me
140		H	H	H	H		H
141		Ph	H	H	Ph		H
142		H	Ph	Ph	H		H
143		H	Ph	H	H		H
144		H	H	H	H		Ph
145		Me	H	H	Me		H
146		H	Me	Me	H		H
147		H	H	H	H		Me

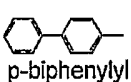
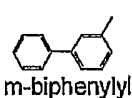
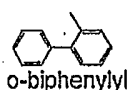
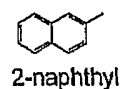
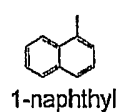
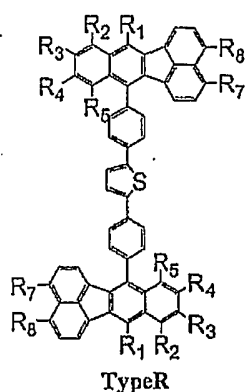

	R ₁	R ₂	R ₃	R ₄	R ₅	R ₇	R ₈
R-1	H	H	H	H	H	H	H
R-2	Ph	H	H	H	H	H	H
R-3	Ph	Ph	H	H	Ph	H	H
R-4	Ph	H	Ph	Ph	H	H	H
R-5	Ph	H	Ph	H	H	H	H
R-6	Ph	H	H	Ph	H	H	H
R-7	Ph	H	H	H	H	Ph	H
R-8	Ph	H	H	H	H	H	Ph
R-9	Ph	H	H	H	H	Ph	Ph
R-10	Ph	H	H	H	H	1-naphthyl	H
R-11	Ph	H	H	H	H	H	1-naphthyl
R-12	Ph	H	H	H	H	1-naphthyl	1-naphthyl
R-13	Ph	H	H	H	H	2-naphthyl	H
R-14	Ph	H	H	H	H	H	2-naphthyl
R-15	Ph	H	H	H	H	2-naphthyl	2-naphthyl
R-16	Ph	H	H	H	H	o-biphenyl	H
R-17	Ph	H	H	H	H	H	o-biphenyl
R-18	Ph	H	H	H	H	o-biphenyl	o-biphenyl
R-19	Ph	H	H	H	H	m-biphenyl	H
R-20	Ph	H	H	H	H	H	m-biphenyl
R-21	Ph	H	H	H	H	m-biphenyl	m-biphenyl
R-22	Ph	H	H	H	H	p-biphenyl	H
R-23	Ph	H	H	H	H	H	p-biphenyl
R-24	Ph	H	H	H	H	p-biphenyl	p-biphenyl
R-25	1-naphthyl	H	H	H	H	H	H
R-26	1-naphthyl	Ph	H	H	Ph	H	H
R-27	1-naphthyl	H	Ph	Ph	H	H	H
R-28	1-naphthyl	H	Ph	H	H	H	H
R-29	1-naphthyl	H	H	Ph	H	H	H
R-30	1-naphthyl	H	H	H	H	Ph	H
R-31	1-naphthyl	H	H	H	H	H	Ph
R-32	1-naphthyl	H	H	H	H	Ph	Ph
R-33	1-naphthyl	H	H	H	H	1-naphthyl	H
R-34	1-naphthyl	H	H	H	H	H	1-naphthyl
R-35	1-naphthyl	H	H	H	H	1-naphthyl	1-naphthyl
R-36	1-naphthyl	H	H	H	H	2-naphthyl	H
R-37	1-naphthyl	H	H	H	H	H	2-naphthyl
R-38	1-naphthyl	H	H	H	H	2-naphthyl	2-naphthyl
R-39	1-naphthyl	H	H	H	H	o-biphenyl	H
R-40	1-naphthyl	H	H	H	H	H	o-biphenyl
R-41	1-naphthyl	H	H	H	H	o-biphenyl	o-biphenyl
R-42	1-naphthyl	H	H	H	H	m-biphenyl	H
R-43	1-naphthyl	H	H	H	H	H	m-biphenyl
R-44	1-naphthyl	H	H	H	H	m-biphenyl	m-biphenyl
R-45	1-naphthyl	H	H	H	H	p-biphenyl	H
R-46	1-naphthyl	H	H	H	H	H	p-biphenyl
R-47	1-naphthyl	H	H	H	H	p-biphenyl	p-biphenyl

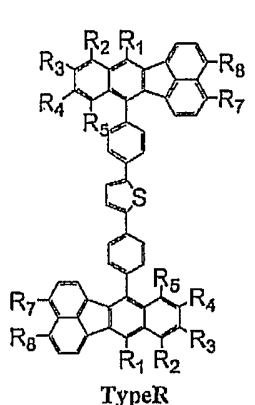
	R ₁	R ₂	R ₃	R ₄	R ₅	R ₇	R ₈	
 <p>TypeR</p>	R-48	2-naphthyl	H	H	H	H	H	
	R-49	2-naphthyl	Ph	H	H	Ph	H	
	R-50	2-naphthyl	H	Ph	Ph	H	H	
	R-51	2-naphthyl	H	Ph	H	H	H	
	R-52	2-naphthyl	H	H	Ph	H	H	
	R-53	2-naphthyl	H	H	H	H	Ph	
	R-54	2-naphthyl	H	H	H	H	H	
	R-55	2-naphthyl	H	H	H	H	Ph	
	R-56	2-naphthyl	H	H	H	H	1-naphthyl	H
	R-57	2-naphthyl	H	H	H	H	H	1-naphthyl
R-58	2-naphthyl	H	H	H	H	1-naphthyl	1-naphthyl	
R-59	2-naphthyl	H	H	H	H	2-naphthyl	H	
R-60	2-naphthyl	H	H	H	H	H	2-naphthyl	
R-61	2-naphthyl	H	H	H	H	2-naphthyl	2-naphthyl	
R-62	2-naphthyl	H	H	H	H	o-biphenyl	H	
R-63	2-naphthyl	H	H	H	H	H	o-biphenyl	
R-64	2-naphthyl	H	H	H	H	o-biphenyl	o-biphenyl	
R-65	2-naphthyl	H	H	H	H	m-biphenyl	H	
R-66	2-naphthyl	H	H	H	H	H	m-biphenyl	
R-67	2-naphthyl	H	H	H	H	m-biphenyl	m-biphenyl	
R-68	2-naphthyl	H	H	H	H	p-biphenyl	H	
R-69	2-naphthyl	H	H	H	H	H	p-biphenyl	
R-70	2-naphthyl	H	H	H	H	p-biphenyl	p-biphenyl	
R-71	o-biphenyl	H	H	H	H	H	H	
R-72	o-biphenyl	Ph	H	H	Ph	H	H	
R-73	o-biphenyl	H	Ph	Ph	H	H	H	
R-74	o-biphenyl	H	Ph	H	H	H	H	
R-75	o-biphenyl	H	H	Ph	H	H	H	
R-76	o-biphenyl	H	H	H	H	Ph	H	
R-77	o-biphenyl	H	H	H	H	H	Ph	
R-78	o-biphenyl	H	H	H	H	Ph	Ph	
R-79	o-biphenyl	H	H	H	H	1-naphthyl	H	
R-80	o-biphenyl	H	H	H	H	H	1-naphthyl	
R-81	o-biphenyl	H	H	H	H	1-naphthyl	1-naphthyl	
R-82	o-biphenyl	H	H	H	H	2-naphthyl	H	
R-83	o-biphenyl	H	H	H	H	H	2-naphthyl	
R-84	o-biphenyl	H	H	H	H	2-naphthyl	2-naphthyl	
R-85	o-biphenyl	H	H	H	H	o-biphenyl	H	
R-86	o-biphenyl	H	H	H	H	H	o-biphenyl	
R-87	o-biphenyl	H	H	H	H	o-biphenyl	o-biphenyl	
R-88	o-biphenyl	H	H	H	H	m-biphenyl	H	
R-89	o-biphenyl	H	H	H	H	H	m-biphenyl	
R-90	o-biphenyl	H	H	H	H	m-biphenyl	m-biphenyl	
R-91	o-biphenyl	H	H	H	H	p-biphenyl	H	
R-92	o-biphenyl	H	H	H	H	H	p-biphenyl	
R-93	o-biphenyl	H	H	H	H	p-biphenyl	p-biphenyl	

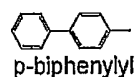
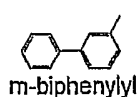
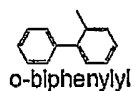
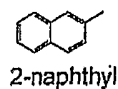
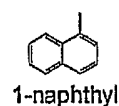
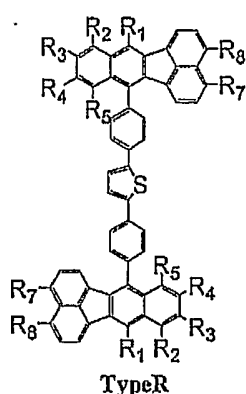

	R ₁	R ₂	R ₃	R ₄	R ₅	R ₇	R ₈
R-94	m-biphenyl	H	H	H	H	H	H
R-95	m-biphenyl	Ph	H	H	Ph	H	H
R-96	m-biphenyl	H	Ph	Ph	H	H	H
R-97	m-biphenyl	H	Ph	H	H	H	H
R-98	m-biphenyl	H	H	Ph	H	H	H
R-99	m-biphenyl	H	H	H	H	Ph	H
R-100	m-biphenyl	H	H	H	H	H	Ph
R-101	m-biphenyl	H	H	H	H	Ph	Ph
R-102	m-biphenyl	H	H	H	H	1-naphthyl	H
R-103	m-biphenyl	H	H	H	H	H	1-naphthyl
R-104	m-biphenyl	H	H	H	H	1-naphthyl	1-naphthyl
R-105	m-biphenyl	H	H	H	H	2-naphthyl	H
R-106	m-biphenyl	H	H	H	H	H	2-naphthyl
R-107	m-biphenyl	H	H	H	H	2-naphthyl	2-naphthyl
R-108	m-biphenyl	H	H	H	H	o-biphenyl	H
R-109	m-biphenyl	H	H	H	H	H	o-biphenyl
R-110	m-biphenyl	H	H	H	H	o-biphenyl	o-biphenyl
R-111	m-biphenyl	H	H	H	H	m-biphenyl	H
R-112	m-biphenyl	H	H	H	H	H	m-biphenyl
R-113	m-biphenyl	H	H	H	H	m-biphenyl	m-biphenyl
R-114	m-biphenyl	H	H	H	H	p-biphenyl	H
R-115	m-biphenyl	H	H	H	H	H	p-biphenyl
R-116	m-biphenyl	H	H	H	H	p-biphenyl	p-biphenyl
R-117	p-biphenyl	H	H	H	H	H	H
R-118	p-biphenyl	Ph	H	H	Ph	H	H
R-119	p-biphenyl	H	Ph	Ph	H	H	H
R-120	p-biphenyl	H	Ph	H	H	H	H
R-121	p-biphenyl	H	H	Ph	H	H	H
R-122	p-biphenyl	H	H	H	H	Ph	H
R-123	p-biphenyl	H	H	H	H	H	Ph
R-124	p-biphenyl	H	H	H	H	Ph	Ph
R-125	p-biphenyl	H	H	H	H	1-naphthyl	H
R-126	p-biphenyl	H	H	H	H	H	1-naphthyl
R-127	p-biphenyl	H	H	H	H	1-naphthyl	1-naphthyl
R-128	p-biphenyl	H	H	H	H	2-naphthyl	H
R-129	p-biphenyl	H	H	H	H	H	2-naphthyl
R-130	p-biphenyl	H	H	H	H	2-naphthyl	2-naphthyl
R-131	p-biphenyl	H	H	H	H	o-biphenyl	H
R-132	p-biphenyl	H	H	H	H	H	o-biphenyl
R-133	p-biphenyl	H	H	H	H	o-biphenyl	o-biphenyl
R-134	p-biphenyl	H	H	H	H	m-biphenyl	H
R-135	p-biphenyl	H	H	H	H	H	m-biphenyl
R-136	p-biphenyl	H	H	H	H	m-biphenyl	m-biphenyl
R-137	p-biphenyl	H	H	H	H	p-biphenyl	H
R-138	p-biphenyl	H	H	H	H	H	p-biphenyl
R-139	p-biphenyl	H	H	H	H	p-biphenyl	p-biphenyl

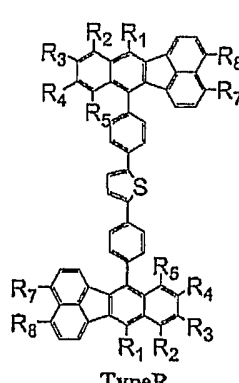
	R ₁	R ₂	R ₃	R ₄	R ₅	R ₇	R ₈
 <p>TypeR</p>	R-140	o-tolyl	H	H	H	H	H
	R-141	o-tolyl	Ph	H	H	Ph	H
	R-142	o-tolyl	H	Ph	Ph	H	H
	R-143	o-tolyl	H	H	H	H	Ph
	R-144	o-tolyl	H	H	H	H	H
	R-145	o-tolyl	H	H	H	H	1-naphthyl
	R-146	o-tolyl	H	H	H	H	H
	R-147	o-tolyl	H	H	H	H	2-naphthyl
	R-148	o-tolyl	H	H	H	H	H
	R-149	o-tolyl	H	H	H	H	o-biphenyl
	R-150	o-tolyl	H	H	H	H	H
	R-151	o-tolyl	H	H	H	H	m-biphenyl
	R-152	o-tolyl	H	H	H	H	H
	R-153	o-tolyl	H	H	H	H	p-biphenyl
	R-154	o-tolyl	H	H	H	H	H
R-155	o-tolyl	H	H	H	H	o-tolyl	
R-156	o-tolyl	H	H	H	H	H	
R-157	m-tolyl	H	H	H	H	H	
R-158	m-tolyl	Ph	H	H	Ph	H	
R-159	m-tolyl	H	Ph	Ph	H	H	
R-160	m-tolyl	H	H	H	H	Ph	
R-161	m-tolyl	H	H	H	H	H	
R-162	m-tolyl	H	H	H	H	1-naphthyl	
R-163	m-tolyl	H	H	H	H	H	
R-164	m-tolyl	H	H	H	H	2-naphthyl	
R-165	m-tolyl	H	H	H	H	H	
R-166	m-tolyl	H	H	H	H	o-biphenyl	
R-167	m-tolyl	H	H	H	H	H	
R-168	m-tolyl	H	H	H	H	m-biphenyl	
R-169	m-tolyl	H	H	H	H	H	
R-170	m-tolyl	H	H	H	H	p-biphenyl	
R-171	m-tolyl	H	H	H	H	H	
R-172	m-tolyl	H	H	H	H	m-tolyl	
R-173	m-tolyl	H	H	H	H	H	
R-174	p-tolyl	H	H	H	H	H	
R-175	p-tolyl	Ph	H	H	Ph	H	
R-176	p-tolyl	H	Ph	Ph	H	H	
R-177	p-tolyl	H	H	H	H	Ph	
R-178	p-tolyl	H	H	H	H	H	
R-179	p-tolyl	H	H	H	H	1-naphthyl	
R-180	p-tolyl	H	H	H	H	H	
R-181	p-tolyl	H	H	H	H	2-naphthyl	
R-182	p-tolyl	H	H	H	H	H	
R-183	p-tolyl	H	H	H	H	o-biphenyl	
R-184	p-tolyl	H	H	H	H	H	
R-185	p-tolyl	H	H	H	H	m-biphenyl	
R-186	p-tolyl	H	H	H	H	H	
R-187	p-tolyl	H	H	H	H	p-biphenyl	
R-188	p-tolyl	H	H	H	H	H	
R-189	p-tolyl	H	H	H	H	p-tolyl	
R-190	p-tolyl	H	H	H	H	H	

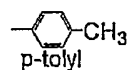
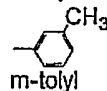
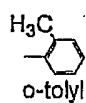
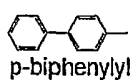
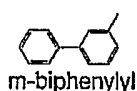
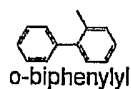
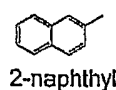
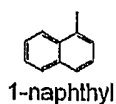

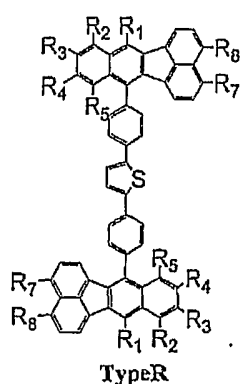

	R ₁	R ₂	R ₃	R ₄	R ₅	R ₇	R ₈
R-191	Ph	H	-CH3	-CH3	H	H	H
R-192	1-naphthyl	H	-CH3	-CH3	H	H	H
R-193	2-naphthyl	H	-CH3	-CH3	H	H	H
R-194	o-biphenyl	H	-CH3	-CH3	H	H	H
R-195	m-biphenyl	H	-CH3	-CH3	H	H	H
R-196	p-biphenyl	H	-CH3	-CH3	H	H	H
R-197	o-tolyl	H	-CH3	-CH3	H	H	H
R-198	m-tolyl	H	-CH3	-CH3	H	H	H
R-199	p-tolyl	H	-CH3	-CH3	H	H	H
R-200	Ph	H	H	H	H	-CH3	H
E-201	1-naphthyl	H	H	H	H	-CH3	H
R-202	2-naphthyl	H	H	H	H	-CH3	H
R-203	o-biphenyl	H	H	H	H	-CH3	H
R-204	m-biphenyl	H	H	H	H	-CH3	H
R-205	p-biphenyl	H	H	H	H	-CH3	H
R-206	o-tolyl	H	H	H	H	-CH3	H
R-207	m-tolyl	H	H	H	H	-CH3	H
R-208	p-tolyl	H	H	H	H	-CH3	H
R-209	Ph	H	H	H	H	H	-CH3
R-210	1-naphthyl	H	H	H	H	H	-CH3
R-211	2-naphthyl	H	H	H	H	H	-CH3
R-212	o-biphenyl	H	H	H	H	H	-CH3
R-213	m-biphenyl	H	H	H	H	H	-CH3
R-214	p-biphenyl	H	H	H	H	H	-CH3
R-215	o-tolyl	H	H	H	H	H	-CH3
R-216	m-tolyl	H	H	H	H	H	-CH3
R-217	p-tolyl	H	H	H	H	H	-CH3
R-218	Ph	H	H	H	H	-CH3	-CH3
R-219	1-naphthyl	H	H	H	H	-CH3	-CH3
R-220	2-naphthyl	H	H	H	H	-CH3	-CH3
R-221	o-biphenyl	H	H	H	H	-CH3	-CH3
R-222	m-biphenyl	H	H	H	H	-CH3	-CH3
R-223	p-biphenyl	H	H	H	H	-CH3	-CH3
R-224	o-tolyl	H	H	H	H	-CH3	-CH3
R-225	m-tolyl	H	H	H	H	-CH3	-CH3
R-226	p-tolyl	H	H	H	H	-CH3	-CH3
R-227	Ph	H	H	H	H	H	DPA
R-228	1-naphthyl	H	H	H	H	H	DPA
R-229	2-naphthyl	H	H	H	H	H	DPA
R-230	o-biphenyl	H	H	H	H	H	DPA
R-231	m-biphenyl	H	H	H	H	H	DPA
R-232	p-biphenyl	H	H	H	H	H	DPA
R-233	Ph	H	H	H	H	DPA	H
R-234	1-naphthyl	H	H	H	H	DPA	H
R-235	2-naphthyl	H	H	H	H	DPA	H
R-236	o-biphenyl	H	H	H	H	DPA	H
R-237	m-biphenyl	H	H	H	H	DPA	H
R-238	p-biphenyl	H	H	H	H	DPA	H
R-239	Ph	H	H	H	H	H	TPA
R-240	1-naphthyl	H	H	H	H	H	TPA
R-241	2-naphthyl	H	H	H	H	H	TPA
R-242	o-biphenyl	H	H	H	H	H	TPA
R-243	m-biphenyl	H	H	H	H	H	TPA
R-244	p-biphenyl	H	H	H	H	H	TPA
R-245	Ph	H	H	H	H	TPA	H
R-246	1-naphthyl	H	H	H	H	TPA	H
R-247	2-naphthyl	H	H	H	H	TPA	H
R-248	o-biphenyl	H	H	H	H	TPA	H
R-249	m-biphenyl	H	H	H	H	TPA	H
R-250	p-biphenyl	H	H	H	H	TPA	H

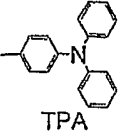
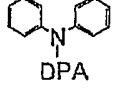
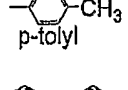
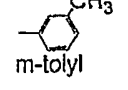
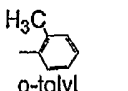
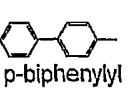
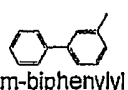
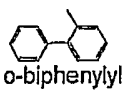
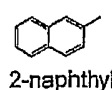
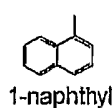

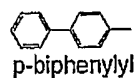
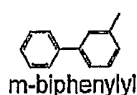
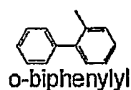
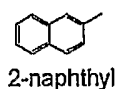
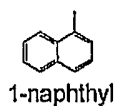
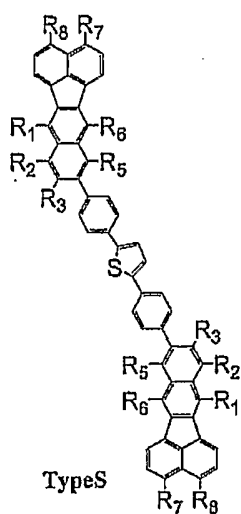

	R ₁	R ₂	R ₃	R ₅	R ₆	R ₇	R ₈
S-1	H	H	H	H	H	H	H
S-2	Ph	H	H	H	Ph	H	H
S-3	Ph	Ph	H	H	Ph	H	H
S-4	Ph	H	H	Ph	Ph	H	H
S-5	Ph	Ph	H	Ph	Ph	H	H
S-6	Ph	H	Ph	H	Ph	H	H
S-7	Ph	H	H	H	Ph	Ph	H
S-8	Ph	H	H	H	Ph	H	Ph
S-9	Ph	H	H	H	Ph	Ph	Ph
S-10	Ph	H	H	H	Ph	1-naphthyl	H
S-11	Ph	H	H	H	Ph	H	1-naphthyl
S-12	Ph	H	H	H	Ph	1-naphthyl	1-naphthyl
S-13	Ph	H	H	H	Ph	2-naphthyl	H
S-14	Ph	H	H	H	Ph	H	2-naphthyl
S-15	Ph	H	H	H	Ph	2-naphthyl	2-naphthyl
S-16	Ph	H	H	H	Ph	o-biphenyl	H
S-17	Ph	H	H	H	Ph	H	o-biphenyl
S-18	Ph	H	H	H	Ph	o-biphenyl	o-biphenyl
S-19	Ph	H	H	H	Ph	m-biphenyl	H
S-20	Ph	H	H	H	Ph	H	m-biphenyl
S-21	Ph	H	H	H	Ph	m-biphenyl	m-biphenyl
S-22	Ph	H	H	H	Ph	p-biphenyl	H
S-23	Ph	H	H	H	Ph	H	p-biphenyl
S-24	Ph	H	H	H	Ph	p-biphenyl	p-biphenyl
S-25	1-naphthyl	H	H	H	1-naphthyl	H	H
S-26	1-naphthyl	Ph	H	H	1-naphthyl	H	H
S-27	1-naphthyl	H	H	Ph	1-naphthyl	H	H
S-28	1-naphthyl	Ph	H	Ph	1-naphthyl	H	H
S-29	1-naphthyl	H	Ph	H	1-naphthyl	H	H
S-30	1-naphthyl	H	H	H	1-naphthyl	Ph	H
S-31	1-naphthyl	H	H	H	1-naphthyl	H	Ph
S-32	1-naphthyl	H	H	H	1-naphthyl	Ph	Ph
S-33	1-naphthyl	H	H	H	1-naphthyl	1-naphthyl	H
S-34	1-naphthyl	H	H	H	1-naphthyl	H	1-naphthyl
S-35	1-naphthyl	H	H	H	1-naphthyl	1-naphthyl	1-naphthyl
S-36	1-naphthyl	H	H	H	1-naphthyl	2-naphthyl	H
S-37	1-naphthyl	H	H	H	1-naphthyl	H	2-naphthyl
S-38	1-naphthyl	H	H	H	1-naphthyl	2-naphthyl	2-naphthyl
S-39	1-naphthyl	H	H	H	1-naphthyl	o-biphenyl	H
S-40	1-naphthyl	H	H	H	1-naphthyl	H	o-biphenyl
S-41	1-naphthyl	H	H	H	1-naphthyl	o-biphenyl	o-biphenyl
S-42	1-naphthyl	H	H	H	1-naphthyl	m-biphenyl	H
S-43	1-naphthyl	H	H	H	1-naphthyl	H	m-biphenyl
S-44	1-naphthyl	H	H	H	1-naphthyl	m-biphenyl	m-biphenyl
S-45	1-naphthyl	H	H	H	1-naphthyl	p-biphenyl	H
S-46	1-naphthyl	H	H	H	1-naphthyl	H	p-biphenyl
S-47	1-naphthyl	H	H	H	1-naphthyl	p-biphenyl	p-biphenyl

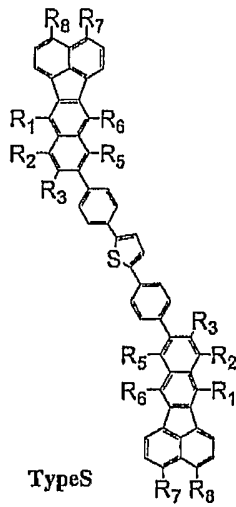
	R ₁	R ₂	R ₃	R ₅	R ₆	R ₇	R ₈	
 <p>Type S</p>	S-48	2-naphthyl	H	H	H	2-naphthyl	H	
	S-49	2-naphthyl	Ph	H	H	2-naphthyl	H	
	S-50	2-naphthyl	H	H	Ph	2-naphthyl	H	
	S-51	2-naphthyl	Ph	H	Ph	2-naphthyl	H	
	S-52	2-naphthyl	H	Ph	H	2-naphthyl	H	
	S-53	2-naphthyl	H	H	H	2-naphthyl	Ph	
	S-54	2-naphthyl	H	H	H	2-naphthyl	H	
	S-55	2-naphthyl	H	H	H	2-naphthyl	Ph	
	S-56	2-naphthyl	H	H	H	2-naphthyl	1-naphthyl	H
	S-57	2-naphthyl	H	H	H	2-naphthyl	H	1-naphthyl
S-58	2-naphthyl	H	H	H	2-naphthyl	1-naphthyl	1-naphthyl	
S-59	2-naphthyl	H	H	H	2-naphthyl	2-naphthyl	H	
S-60	2-naphthyl	H	H	H	2-naphthyl	H	2-naphthyl	
S-61	2-naphthyl	H	H	H	2-naphthyl	2-naphthyl	2-naphthyl	
S-62	2-naphthyl	H	H	H	2-naphthyl	o-biphenyl	H	
S-63	2-naphthyl	H	H	H	2-naphthyl	H	o-biphenyl	
S-64	2-naphthyl	H	H	H	2-naphthyl	o-biphenyl	o-biphenyl	
S-65	2-naphthyl	H	H	H	2-naphthyl	m-biphenyl	H	
S-66	2-naphthyl	H	H	H	2-naphthyl	H	m-biphenyl	
S-67	2-naphthyl	H	H	H	2-naphthyl	m-biphenyl	m-biphenyl	
S-68	2-naphthyl	H	H	H	2-naphthyl	p-biphenyl	H	
S-69	2-naphthyl	H	H	H	2-naphthyl	H	p-biphenyl	
S-70	2-naphthyl	H	H	H	2-naphthyl	p-biphenyl	p-biphenyl	
S-71	o-biphenyl	H	H	H	o-biphenyl	H	H	
S-72	o-biphenyl	Ph	H	H	o-biphenyl	H	H	
S-73	o-biphenyl	H	H	Ph	o-biphenyl	H	H	
S-74	o-biphenyl	Ph	H	Ph	o-biphenyl	H	H	
S-75	o-biphenyl	H	Ph	H	o-biphenyl	H	H	
S-76	o-biphenyl	H	H	H	o-biphenyl	Ph	H	
S-77	o-biphenyl	H	H	H	o-biphenyl	H	Ph	
S-78	o-biphenyl	H	H	H	o-biphenyl	Ph	Ph	
S-79	o-biphenyl	H	H	H	o-biphenyl	1-naphthyl	H	
S-80	o-biphenyl	H	H	H	o-biphenyl	H	1-naphthyl	
S-81	o-biphenyl	H	H	H	o-biphenyl	1-naphthyl	1-naphthyl	
S-82	o-biphenyl	H	H	H	o-biphenyl	2-naphthyl	H	
S-83	o-biphenyl	H	H	H	o-biphenyl	H	2-naphthyl	
S-84	o-biphenyl	H	H	H	o-biphenyl	2-naphthyl	2-naphthyl	
S-85	o-biphenyl	H	H	H	o-biphenyl	o-biphenyl	H	
S-86	o-biphenyl	H	H	H	o-biphenyl	H	o-biphenyl	
S-87	o-biphenyl	H	H	H	o-biphenyl	o-biphenyl	o-biphenyl	
S-88	o-biphenyl	H	H	H	o-biphenyl	m-biphenyl	H	
S-89	o-biphenyl	H	H	H	o-biphenyl	H	m-biphenyl	
S-90	o-biphenyl	H	H	H	o-biphenyl	m-biphenyl	m-biphenyl	
S-91	o-biphenyl	H	H	H	o-biphenyl	p-biphenyl	H	
S-92	o-biphenyl	H	H	H	o-biphenyl	H	p-biphenyl	
S-93	o-biphenyl	H	H	H	o-biphenyl	p-biphenyl	p-biphenyl	

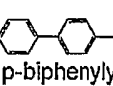
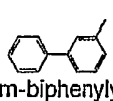
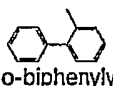
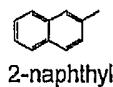
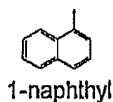

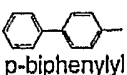
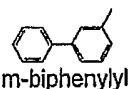
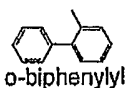
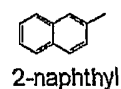
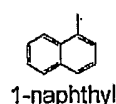
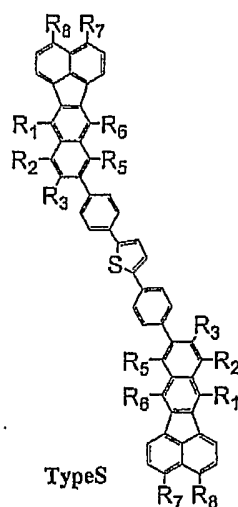

	R ₁	R ₂	R ₃	R ₅	R ₆	R ₇	R ₈
S-94	m-biphenyl	H	H	H	m-biphenyl	H	H
S-95	m-biphenyl	Ph	H	H	m-biphenyl	H	H
S-96	m-biphenyl	H	H	Ph	m-biphenyl	H	H
S-97	m-biphenyl	Ph	H	Ph	m-biphenyl	H	H
S-98	m-biphenyl	H	Ph	H	m-biphenyl	H	H
S-99	m-biphenyl	H	H	H	m-biphenyl	Ph	H
S-100	m-biphenyl	H	H	H	m-biphenyl	H	Ph
S-101	m-biphenyl	H	H	H	m-biphenyl	Ph	Ph
S-102	m-biphenyl	H	H	H	m-biphenyl	1-naphthyl	H
S-103	m-biphenyl	H	H	H	m-biphenyl	H	1-naphthyl
S-104	m-biphenyl	H	H	H	m-biphenyl	1-naphthyl	1-naphthyl
S-105	m-biphenyl	H	H	H	m-biphenyl	2-naphthyl	H
S-106	m-biphenyl	H	H	H	m-biphenyl	H	2-naphthyl
S-107	m-biphenyl	H	H	H	m-biphenyl	2-naphthyl	2-naphthyl
S-108	m-biphenyl	H	H	H	m-biphenyl	o-biphenyl	H
S-109	m-biphenyl	H	H	H	m-biphenyl	H	o-biphenyl
S-110	m-biphenyl	H	H	H	m-biphenyl	o-biphenyl	o-biphenyl
S-111	m-biphenyl	H	H	H	m-biphenyl	m-biphenyl	H
S-112	m-biphenyl	H	H	H	m-biphenyl	H	m-biphenyl
S-113	m-biphenyl	H	H	H	m-biphenyl	m-biphenyl	m-biphenyl
S-114	m-biphenyl	H	H	H	m-biphenyl	p-biphenyl	H
S-115	m-biphenyl	H	H	H	m-biphenyl	H	p-biphenyl
S-116	m-biphenyl	H	H	H	m-biphenyl	p-biphenyl	p-biphenyl
S-117	p-biphenyl	H	H	H	p-biphenyl	H	H
S-118	p-biphenyl	Ph	H	H	p-biphenyl	H	H
S-119	p-biphenyl	H	H	Ph	p-biphenyl	H	H
S-120	p-biphenyl	Ph	H	Ph	p-biphenyl	H	H
S-121	p-biphenyl	H	Ph	H	p-biphenyl	H	H
S-122	p-biphenyl	H	H	H	p-biphenyl	Ph	H
S-123	p-biphenyl	H	H	H	p-biphenyl	H	Ph
S-124	p-biphenyl	H	H	H	p-biphenyl	Ph	Ph
S-125	p-biphenyl	H	H	H	p-biphenyl	1-naphthyl	H
S-126	p-biphenyl	H	H	H	p-biphenyl	H	1-naphthyl
S-127	p-biphenyl	H	H	H	p-biphenyl	1-naphthyl	1-naphthyl
S-128	p-biphenyl	H	H	H	p-biphenyl	2-naphthyl	H
S-129	p-biphenyl	H	H	H	p-biphenyl	H	2-naphthyl
S-130	p-biphenyl	H	H	H	p-biphenyl	2-naphthyl	2-naphthyl
S-131	p-biphenyl	H	H	H	p-biphenyl	o-biphenyl	H
S-132	p-biphenyl	H	H	H	p-biphenyl	H	o-biphenyl
S-133	p-biphenyl	H	H	H	p-biphenyl	o-biphenyl	o-biphenyl
S-134	p-biphenyl	H	H	H	p-biphenyl	m-biphenyl	H
S-135	p-biphenyl	H	H	H	p-biphenyl	H	m-biphenyl
S-136	p-biphenyl	H	H	H	p-biphenyl	m-biphenyl	m-biphenyl
S-137	p-biphenyl	H	H	H	p-biphenyl	p-biphenyl	H
S-138	p-biphenyl	H	H	H	p-biphenyl	H	p-biphenyl
S-139	p-biphenyl	H	H	H	p-biphenyl	p-biphenyl	p-biphenyl

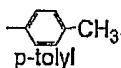
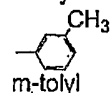
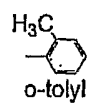
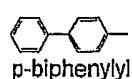
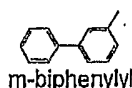
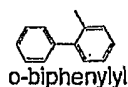
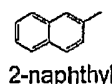
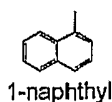
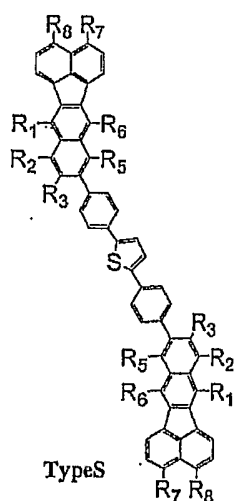

	R ₁	R ₂	R ₃	R ₅	R ₆	R ₇	R ₈
S-140	o-tolyl	H	H	H	o-tolyl	H	H
S-141	o-tolyl	Ph	H	Ph	o-tolyl	H	H
S-142	o-tolyl	H	Ph	H	o-tolyl	H	H
S-143	o-tolyl	H	H	H	o-tolyl	Ph	H
S-144	o-tolyl	H	H	H	o-tolyl	H	Ph
S-145	o-tolyl	H	H	H	o-tolyl	1-naphthyl	H
S-146	o-tolyl	H	H	H	o-tolyl	H	1-naphthyl
S-147	o-tolyl	H	H	H	o-tolyl	2-naphthyl	H
S-148	o-tolyl	H	H	H	o-tolyl	H	2-naphthyl
S-149	o-tolyl	H	H	H	o-tolyl	o-biphenyl	H
S-150	o-tolyl	H	H	H	o-tolyl	H	o-biphenyl
S-151	o-tolyl	H	H	H	o-tolyl	m-biphenyl	H
S-152	o-tolyl	H	H	H	o-tolyl	H	m-biphenyl
S-153	o-tolyl	H	H	H	o-tolyl	p-biphenyl	H
S-154	o-tolyl	H	H	H	o-tolyl	H	p-biphenyl
S-155	o-tolyl	H	H	H	o-tolyl	o-tolyl	H
S-156	o-tolyl	H	H	H	o-tolyl	H	o-tolyl
S-157	m-tolyl	H	H	H	m-tolyl	H	H
S-158	m-tolyl	Ph	H	Ph	m-tolyl	H	H
S-159	m-tolyl	H	Ph	H	m-tolyl	H	H
S-160	m-tolyl	H	H	H	m-tolyl	Ph	H
S-161	m-tolyl	H	H	H	m-tolyl	H	Ph
S-162	m-tolyl	H	H	H	m-tolyl	1-naphthyl	H
S-163	m-tolyl	H	H	H	m-tolyl	H	1-naphthyl
S-164	m-tolyl	H	H	H	m-tolyl	2-naphthyl	H
S-165	m-tolyl	H	H	H	m-tolyl	H	2-naphthyl
S-166	m-tolyl	H	H	H	m-tolyl	o-biphenyl	H
S-167	m-tolyl	H	H	H	m-tolyl	H	o-biphenyl
S-168	m-tolyl	H	H	H	m-tolyl	m-biphenyl	H
S-169	m-tolyl	H	H	H	m-tolyl	H	m-biphenyl
S-170	m-tolyl	H	H	H	m-tolyl	p-biphenyl	H
S-171	m-tolyl	H	H	H	m-tolyl	H	p-biphenyl
S-172	m-tolyl	H	H	H	m-tolyl	m-tolyl	H
S-173	m-tolyl	H	H	H	m-tolyl	H	m-tolyl
S-174	p-tolyl	H	H	H	p-tolyl	H	H
S-175	p-tolyl	Ph	H	Ph	p-tolyl	H	H
S-176	p-tolyl	H	Ph	H	p-tolyl	H	H
S-177	p-tolyl	H	H	H	p-tolyl	Ph	H
S-178	p-tolyl	H	H	H	p-tolyl	H	Ph
S-179	p-tolyl	H	H	H	p-tolyl	1-naphthyl	H
S-180	p-tolyl	H	H	H	p-tolyl	H	1-naphthyl
S-181	p-tolyl	H	H	H	p-tolyl	2-naphthyl	H
S-182	p-tolyl	H	H	H	p-tolyl	H	2-naphthyl
S-183	p-tolyl	H	H	H	p-tolyl	o-biphenyl	H
S-184	p-tolyl	H	H	H	p-tolyl	H	o-biphenyl
S-185	p-tolyl	H	H	H	p-tolyl	m-biphenyl	H
S-186	p-tolyl	H	H	H	p-tolyl	H	m-biphenyl
S-187	p-tolyl	H	H	H	p-tolyl	p-biphenyl	H
S-188	p-tolyl	H	H	H	p-tolyl	H	p-biphenyl
S-189	p-tolyl	H	H	H	p-tolyl	p-tolyl	H
S-190	p-tolyl	H	H	H	p-tolyl	H	p-tolyl

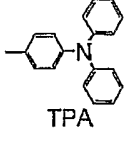
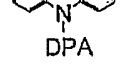
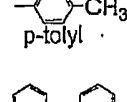
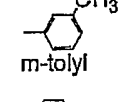
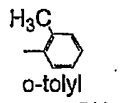
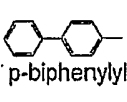
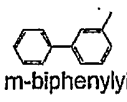
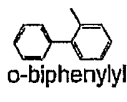
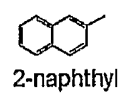
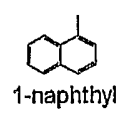
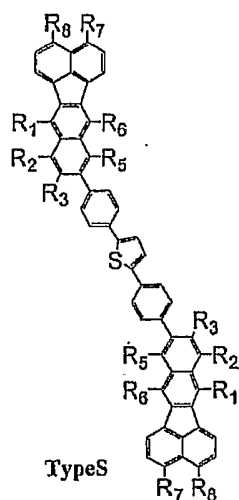

	R ₁	R ₂	R ₃	R ₅	R ₆	R ₇	R ₈
S-191	Ph	H	-CH3	H	Ph	H	H
S-192	1-naphthyl	H	-CH3	H	1-naphthyl	H	H
S-193	2-naphthyl	H	-CH3	H	2-naphthyl	H	H
S-194	o-biphenyl	H	-CH3	H	o-biphenyl	H	H
S-195	m-biphenyl	H	-CH3	H	m-biphenyl	H	H
S-196	p-biphenyl	H	-CH3	H	p-biphenyl	H	H
S-197	o-tolyl	H	-CH3	H	o-tolyl	H	H
S-198	m-tolyl	H	-CH3	H	m-tolyl	H	H
S-199	p-tolyl	H	-CH3	H	p-tolyl	H	H
S-200	Ph	H	H	H	Ph	-CH3	H
S-201	1-naphthyl	H	H	H	1-naphthyl	-CH3	H
S-202	2-naphthyl	H	H	H	2-naphthyl	-CH3	H
S-203	o-biphenyl	H	H	H	o-biphenyl	-CH3	H
S-204	m-biphenyl	H	H	H	m-biphenyl	-CH3	H
S-205	p-biphenyl	H	H	H	p-biphenyl	-CH3	H
S-206	o-tolyl	H	H	H	o-tolyl	-CH3	H
S-207	m-tolyl	H	H	H	m-tolyl	-CH3	H
S-208	p-tolyl	H	H	H	p-tolyl	-CH3	H
S-209	Ph	H	H	H	Ph	H	-CH3
S-210	1-naphthyl	H	H	H	1-naphthyl	H	-CH3
S-211	2-naphthyl	H	H	H	2-naphthyl	H	-CH3
S-212	o-biphenyl	H	H	H	o-biphenyl	H	-CH3
S-213	m-biphenyl	H	H	H	m-biphenyl	H	-CH3
S-214	p-biphenyl	H	H	H	p-biphenyl	H	-CH3
S-215	o-tolyl	H	H	H	o-tolyl	H	-CH3
S-216	m-tolyl	H	H	H	m-tolyl	H	-CH3
S-217	p-tolyl	H	H	H	p-tolyl	H	-CH3
S-218	Ph	H	H	H	Ph	-CH3	-CH3
S-219	1-naphthyl	H	H	H	1-naphthyl	-CH3	-CH3
S-220	2-naphthyl	H	H	H	2-naphthyl	-CH3	-CH3
S-221	o-biphenyl	H	H	H	o-biphenyl	-CH3	-CH3
S-222	m-biphenyl	H	H	H	m-biphenyl	-CH3	-CH3
S-223	p-biphenyl	H	H	H	p-biphenyl	-CH3	-CH3
S-224	o-tolyl	H	H	H	o-tolyl	-CH3	-CH3
S-225	m-tolyl	H	H	H	m-tolyl	-CH3	-CH3
S-226	p-tolyl	H	H	H	p-tolyl	-CH3	-CH3
S-227	Ph	H	H	H	Ph	H	DPA
S-228	1-naphthyl	H	H	H	1-naphthyl	H	DPA
S-229	2-naphthyl	H	H	H	2-naphthyl	H	DPA
S-230	o-biphenyl	H	H	H	o-biphenyl	H	DPA
S-231	m-biphenyl	H	H	H	m-biphenyl	H	DPA
S-232	p-biphenyl	H	H	H	p-biphenyl	H	DPA
S-233	Ph	H	H	H	Ph	DPA	H
S-234	1-naphthyl	H	H	H	1-naphthyl	DPA	H
S-235	2-naphthyl	H	H	H	2-naphthyl	DPA	H
S-236	o-biphenyl	H	H	H	o-biphenyl	DPA	H
S-237	m-biphenyl	H	H	H	m-biphenyl	DPA	H
S-238	p-biphenyl	H	H	H	p-biphenyl	DPA	H
S-239	Ph	H	H	H	Ph	H	TPA
S-240	1-naphthyl	H	H	H	1-naphthyl	H	TPA
S-241	2-naphthyl	H	H	H	2-naphthyl	H	TPA
S-242	o-biphenyl	H	H	H	o-biphenyl	H	TPA
S-243	m-biphenyl	H	H	H	m-biphenyl	H	TPA
S-244	p-biphenyl	H	H	H	p-biphenyl	H	TPA
S-245	Ph	H	H	H	Ph	TPA	H
S-246	1-naphthyl	H	H	H	1-naphthyl	TPA	H
S-247	2-naphthyl	H	H	H	2-naphthyl	TPA	H
S-248	o-biphenyl	H	H	H	o-biphenyl	TPA	H
S-249	m-biphenyl	H	H	H	m-biphenyl	TPA	H
S-250	p-biphenyl	H	H	H	p-biphenyl	TPA	H

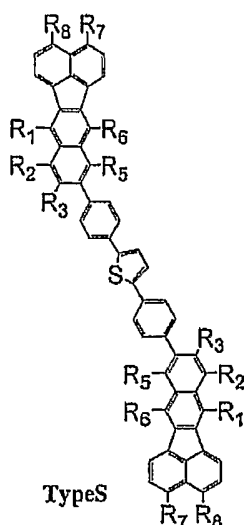

	R ₁	R ₂	R ₃	R ₅	R ₆	R ₇	R ₈
S-251	Ph	H	H	H	1-naphthyl	H	H
S-252	Ph	H	H	H	2-naphthyl	H	H
S-253	Ph	H	H	H	o-biphenyl	H	H
S-254	Ph	H	H	H	m-biphenyl	H	H
S-255	Ph	H	H	H	p-biphenyl	H	H
S-256	Ph	H	H	H	O-tolyl	H	H
S-257	Ph	H	H	H	m-tolyl	H	H
S-258	Ph	H	H	H	p-tolyl	H	H
S-259	1-naphthyl	H	H	H	2-naphthyl	H	H
S-260	1-naphthyl	H	H	H	o-biphenyl	H	H
S-261	1-naphthyl	H	H	H	m-biphenyl	H	H
S-262	1-naphthyl	H	H	H	p-biphenyl	H	H
S-263	1-naphthyl	H	H	H	O-tolyl	H	H
S-264	1-naphthyl	H	H	H	m-tolyl	H	H
S-265	1-naphthyl	H	H	H	p-tolyl	H	H
S-266	2-naphthyl	H	H	H	o-biphenyl	H	H
S-267	2-naphthyl	H	H	H	m-biphenyl	H	H
S-268	2-naphthyl	H	H	H	p-biphenyl	H	H
S-269	2-naphthyl	H	H	H	O-tolyl	H	H
S-270	2-naphthyl	H	H	H	m-tolyl	H	H
S-271	2-naphthyl	H	H	H	p-tolyl	H	H
S-272	o-biphenyl	H	H	H	m-biphenyl	H	H
S-273	o-biphenyl	H	H	H	p-biphenyl	H	H
S-274	o-biphenyl	H	H	H	O-tolyl	H	H
S-275	o-biphenyl	H	H	H	m-tolyl	H	H
S-276	o-biphenyl	H	H	H	p-tolyl	H	H
S-277	m-biphenyl	H	H	H	p-biphenyl	H	H
S-278	m-biphenyl	H	H	H	O-tolyl	H	H
S-279	m-biphenyl	H	H	H	m-tolyl	H	H
S-280	m-biphenyl	H	H	H	p-tolyl	H	H
S-281	p-biphenyl	H	H	H	O-tolyl	H	H
S-282	p-biphenyl	H	H	H	m-tolyl	H	H
S-283	p-biphenyl	H	H	H	p-tolyl	H	H
S-284	O-tolyl	H	H	H	m-tolyl	H	H
S-285	O-tolyl	H	H	H	p-tolyl	H	H
S-286	m-tolyl	H	H	H	p-tolyl	H	H

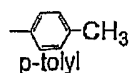
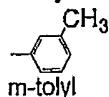
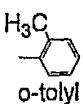
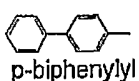
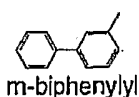
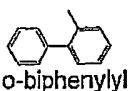
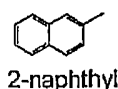
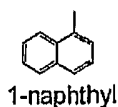

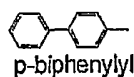
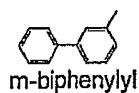
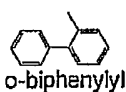
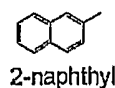
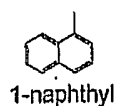
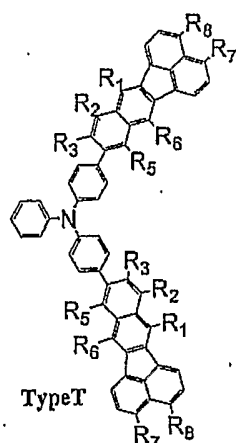

	R ₁	R ₂	R ₃	R ₅	R ₆	R ₇	R ₈
T-1	H	H	H	H	H	H	H
T-2	Ph	H	H	H	Ph	H	H
T-3	Ph	Ph	H	H	Ph	H	H
T-4	Ph	H	H	Ph	Ph	H	H
T-5	Ph	Ph	H	Ph	Ph	H	H
T-6	Ph	H	Ph	H	Ph	H	H
T-7	Ph	H	H	H	Ph	Ph	H
T-8	Ph	H	H	H	Ph	H	Ph
T-9	Ph	H	H	H	Ph	Ph	Ph
T-10	Ph	H	H	H	Ph	1-naphthyl	H
T-11	Ph	H	H	H	Ph	H	1-naphthyl
T-12	Ph	H	H	H	Ph	1-naphthyl	1-naphthyl
T-13	Ph	H	H	H	Ph	2-naphthyl	H
T-14	Ph	H	H	H	Ph	H	2-naphthyl
T-15	Ph	H	H	H	Ph	2-naphthyl	2-naphthyl
T-16	Ph	H	H	H	Ph	o-biphenyl	H
T-17	Ph	H	H	H	Ph	H	o-biphenyl
T-18	Ph	H	H	H	Ph	o-biphenyl	o-biphenyl
T-19	Ph	H	H	H	Ph	m-biphenyl	H
T-20	Ph	H	H	H	Ph	H	m-biphenyl
T-21	Ph	H	H	H	Ph	m-biphenyl	m-biphenyl
T-22	Ph	H	H	H	Ph	p-biphenyl	H
T-23	Ph	H	H	H	Ph	H	p-biphenyl
T-24	Ph	H	H	H	Ph	p-biphenyl	p-biphenyl
T-25	1-naphthyl	H	H	H	1-naphthyl	H	H
T-26	1-naphthyl	Ph	H	H	1-naphthyl	H	H
T-27	1-naphthyl	H	H	Ph	1-naphthyl	H	H
T-28	1-naphthyl	Ph	H	Ph	1-naphthyl	H	H
T-29	1-naphthyl	H	Ph	H	1-naphthyl	H	H
T-30	1-naphthyl	H	H	H	1-naphthyl	Ph	H
T-31	1-naphthyl	H	H	H	1-naphthyl	H	Ph
T-32	1-naphthyl	H	H	H	1-naphthyl	Ph	Ph
T-33	1-naphthyl	H	H	H	1-naphthyl	1-naphthyl	H
T-34	1-naphthyl	H	H	H	1-naphthyl	H	1-naphthyl
T-35	1-naphthyl	H	H	H	1-naphthyl	1-naphthyl	1-naphthyl
T-36	1-naphthyl	H	H	H	1-naphthyl	2-naphthyl	H
T-37	1-naphthyl	H	H	H	1-naphthyl	H	2-naphthyl
T-38	1-naphthyl	H	H	H	1-naphthyl	2-naphthyl	2-naphthyl
T-39	1-naphthyl	H	H	H	1-naphthyl	o-biphenyl	H
T-40	1-naphthyl	H	H	H	1-naphthyl	H	o-biphenyl
T-41	1-naphthyl	H	H	H	1-naphthyl	o-biphenyl	o-biphenyl
T-42	1-naphthyl	H	H	H	1-naphthyl	m-biphenyl	H
T-43	1-naphthyl	H	H	H	1-naphthyl	H	m-biphenyl
T-44	1-naphthyl	H	H	H	1-naphthyl	m-biphenyl	m-biphenyl
T-45	1-naphthyl	H	H	H	1-naphthyl	p-biphenyl	H
T-46	1-naphthyl	H	H	H	1-naphthyl	H	p-biphenyl
T-47	1-naphthyl	H	H	H	1-naphthyl	p-biphenyl	p-biphenyl

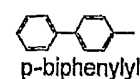
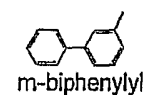
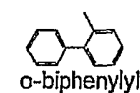
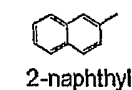
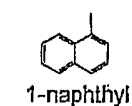
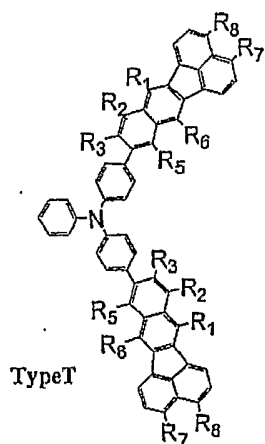

	R ₁	R ₂	R ₃	R ₅	R ₆	R ₇	R ₈
T-48	2-naphthyl	H	H	H	2-naphthyl	H	H
T-49	2-naphthyl	Ph	H	H	2-naphthyl	H	H
T-50	2-naphthyl	H	H	Ph	2-naphthyl	H	H
T-51	2-naphthyl	Ph	H	Ph	2-naphthyl	H	H
T-52	2-naphthyl	H	Ph	H	2-naphthyl	H	H
T-53	2-naphthyl	H	H	H	2-naphthyl	Ph	H
T-54	2-naphthyl	H	H	H	2-naphthyl	H	Ph
T-55	2-naphthyl	H	H	H	2-naphthyl	Ph	Ph
T-56	2-naphthyl	H	H	H	2-naphthyl	1-naphthyl	H
T-57	2-naphthyl	H	H	H	2-naphthyl	H	1-naphthyl
T-58	2-naphthyl	H	H	H	2-naphthyl	1-naphthyl	1-naphthyl
T-59	2-naphthyl	H	H	H	2-naphthyl	2-naphthyl	H
T-60	2-naphthyl	H	H	H	2-naphthyl	H	2-naphthyl
T-61	2-naphthyl	H	H	H	2-naphthyl	2-naphthyl	2-naphthyl
T-62	2-naphthyl	H	H	H	2-naphthyl	o-biphenyl	H
T-63	2-naphthyl	H	H	H	2-naphthyl	H	o-biphenyl
T-64	2-naphthyl	H	H	H	2-naphthyl	o-biphenyl	o-biphenyl
T-65	2-naphthyl	H	H	H	2-naphthyl	m-biphenyl	H
T-66	2-naphthyl	H	H	H	2-naphthyl	H	m-biphenyl
T-67	2-naphthyl	H	H	H	2-naphthyl	m-biphenyl	m-biphenyl
T-68	2-naphthyl	H	H	H	2-naphthyl	p-biphenyl	H
T-69	2-naphthyl	H	H	H	2-naphthyl	H	p-biphenyl
T-70	2-naphthyl	H	H	H	2-naphthyl	p-biphenyl	p-biphenyl
T-71	o-biphenyl	H	H	H	o-biphenyl	H	H
T-72	o-biphenyl	Ph	H	H	o-biphenyl	H	H
T-73	o-biphenyl	H	H	Ph	o-biphenyl	H	H
T-74	o-biphenyl	Ph	H	Ph	o-biphenyl	H	H
T-75	o-biphenyl	H	Ph	H	o-biphenyl	H	H
T-76	o-biphenyl	H	H	H	o-biphenyl	Ph	H
T-77	o-biphenyl	H	H	H	o-biphenyl	H	Ph
T-78	o-biphenyl	H	H	H	o-biphenyl	Ph	Ph
T-79	o-biphenyl	H	H	H	o-biphenyl	1-naphthyl	H
T-80	o-biphenyl	H	H	H	o-biphenyl	H	1-naphthyl
T-81	o-biphenyl	H	H	H	o-biphenyl	1-naphthyl	1-naphthyl
T-82	o-biphenyl	H	H	H	o-biphenyl	2-naphthyl	H
T-83	o-biphenyl	H	H	H	o-biphenyl	H	2-naphthyl
T-84	o-biphenyl	H	H	H	o-biphenyl	2-naphthyl	2-naphthyl
T-85	o-biphenyl	H	H	H	o-biphenyl	o-biphenyl	H
T-86	o-biphenyl	H	H	H	o-biphenyl	H	o-biphenyl
T-87	o-biphenyl	H	H	H	o-biphenyl	o-biphenyl	o-biphenyl
T-88	o-biphenyl	H	H	H	o-biphenyl	m-biphenyl	H
T-89	o-biphenyl	H	H	H	o-biphenyl	H	m-biphenyl
T-90	o-biphenyl	H	H	H	o-biphenyl	m-biphenyl	m-biphenyl
T-91	o-biphenyl	H	H	H	o-biphenyl	p-biphenyl	H
T-92	o-biphenyl	H	H	H	o-biphenyl	H	p-biphenyl
T-93	o-biphenyl	H	H	H	o-biphenyl	p-biphenyl	p-biphenyl

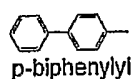
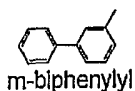
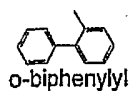
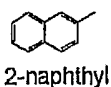
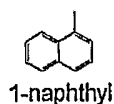
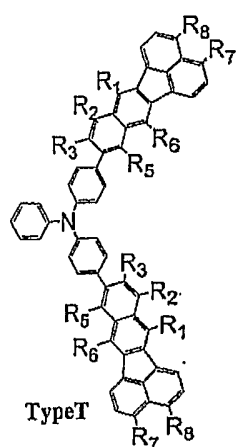

	R ₁	R ₂	R ₃	R ₅	R ₆	R ₇	R ₈
T-94	m-biphenyl	H	H	H	m-biphenyl	H	H
T-95	m-biphenyl	Ph	H	H	m-biphenyl	H	H
T-96	m-biphenyl	H	H	Ph	m-biphenyl	H	H
T-97	m-biphenyl	Ph	H	Ph	m-biphenyl	H	H
T-98	m-biphenyl	H	Ph	H	m-biphenyl	H	H
T-99	m-biphenyl	H	H	H	m-biphenyl	Ph	H
T-100	m-biphenyl	H	H	H	m-biphenyl	H	Ph
T-101	m-biphenyl	H	H	H	m-biphenyl	Ph	Ph
T-102	m-biphenyl	H	H	H	m-biphenyl	1-naphthyl	H
T-103	m-biphenyl	H	H	H	m-biphenyl	H	1-naphthyl
T-104	m-biphenyl	H	H	H	m-biphenyl	1-naphthyl	1-naphthyl
T-105	m-biphenyl	H	H	H	m-biphenyl	2-naphthyl	H
T-106	m-biphenyl	H	H	H	m-biphenyl	H	2-naphthyl
T-107	m-biphenyl	H	H	H	m-biphenyl	2-naphthyl	2-naphthyl
T-108	m-biphenyl	H	H	H	m-biphenyl	o-biphenyl	H
T-109	m-biphenyl	H	H	H	m-biphenyl	H	o-biphenyl
T-110	m-biphenyl	H	H	H	m-biphenyl	o-biphenyl	o-biphenyl
T-111	m-biphenyl	H	H	H	m-biphenyl	m-biphenyl	H
T-112	m-biphenyl	H	H	H	m-biphenyl	H	m-biphenyl
T-113	m-biphenyl	H	H	H	m-biphenyl	m-biphenyl	m-biphenyl
T-114	m-biphenyl	H	H	H	m-biphenyl	p-biphenyl	H
T-115	m-biphenyl	H	H	H	m-biphenyl	H	p-biphenyl
T-116	m-biphenyl	H	H	H	m-biphenyl	p-biphenyl	p-biphenyl
T-117	p-biphenyl	H	H	H	p-biphenyl	H	H
T-118	p-biphenyl	Ph	H	H	p-biphenyl	H	H
T-119	p-biphenyl	H	H	Ph	p-biphenyl	H	H
T-120	p-biphenyl	Ph	H	Ph	p-biphenyl	H	H
T-121	p-biphenyl	H	Ph	H	p-biphenyl	H	H
T-122	p-biphenyl	H	H	H	p-biphenyl	Ph	H
T-123	p-biphenyl	H	H	H	p-biphenyl	H	Ph
T-124	p-biphenyl	H	H	H	p-biphenyl	Ph	Ph
T-125	p-biphenyl	H	H	H	p-biphenyl	1-naphthyl	H
T-126	p-biphenyl	H	H	H	p-biphenyl	H	1-naphthyl
T-127	p-biphenyl	H	H	H	p-biphenyl	1-naphthyl	1-naphthyl
T-128	p-biphenyl	H	H	H	p-biphenyl	2-naphthyl	H
T-129	p-biphenyl	H	H	H	p-biphenyl	H	2-naphthyl
T-130	p-biphenyl	H	H	H	p-biphenyl	2-naphthyl	2-naphthyl
T-131	p-biphenyl	H	H	H	p-biphenyl	o-biphenyl	H
T-132	p-biphenyl	H	H	H	p-biphenyl	H	o-biphenyl
T-133	p-biphenyl	H	H	H	p-biphenyl	o-biphenyl	o-biphenyl
T-134	p-biphenyl	H	H	H	p-biphenyl	m-biphenyl	H
T-135	p-biphenyl	H	H	H	p-biphenyl	H	m-biphenyl
T-136	p-biphenyl	H	H	H	p-biphenyl	m-biphenyl	m-biphenyl
T-137	p-biphenyl	H	H	H	p-biphenyl	p-biphenyl	H
T-138	p-biphenyl	H	H	H	p-biphenyl	H	p-biphenyl
T-139	p-biphenyl	H	H	H	p-biphenyl	p-biphenyl	p-biphenyl

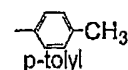
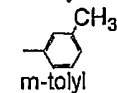
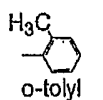
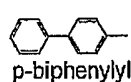
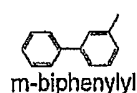
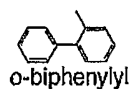
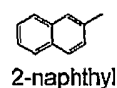
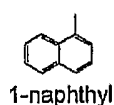
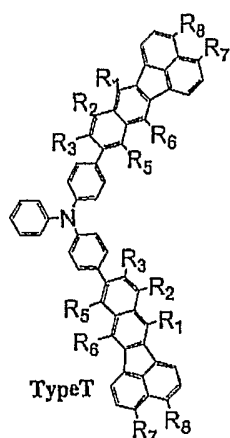

	R ₁	R ₂	R ₃	R ₅	R ₆	R ₇	R ₈
T-140	o-tolyl	H	H	H	o-tolyl	H	H
T-141	o-tolyl	Ph	H	Ph	o-tolyl	H	H
T-142	o-tolyl	H	Ph	H	o-tolyl	H	H
T-143	o-tolyl	H	H	H	o-tolyl	Ph	H
T-144	o-tolyl	H	H	H	o-tolyl	H	Ph
T-145	o-tolyl	H	H	H	o-tolyl	1-naphthyl	H
T-146	o-tolyl	H	H	H	o-tolyl	H	1-naphthyl
T-147	o-tolyl	H	H	H	o-tolyl	2-naphthyl	H
T-148	o-tolyl	H	H	H	o-tolyl	H	2-naphthyl
T-149	o-tolyl	H	H	H	o-tolyl	o-biphenyl	H
T-150	o-tolyl	H	H	H	o-tolyl	H	o-biphenyl
T-151	o-tolyl	H	H	H	o-tolyl	m-biphenyl	H
T-152	o-tolyl	H	H	H	o-tolyl	H	m-biphenyl
T-153	o-tolyl	H	H	H	o-tolyl	p-biphenyl	H
T-154	o-tolyl	H	H	H	o-tolyl	H	p-biphenyl
T-155	o-tolyl	H	H	H	o-tolyl	o-tolyl	H
T-156	o-tolyl	H	H	H	o-tolyl	H	o-tolyl
T-157	m-tolyl	H	H	H	m-tolyl	H	H
T-158	m-tolyl	Ph	H	Ph	m-tolyl	H	H
T-159	m-tolyl	H	Ph	H	m-tolyl	H	H
T-160	m-tolyl	H	H	H	m-tolyl	Ph	H
T-161	m-tolyl	H	H	H	m-tolyl	H	Ph
T-162	m-tolyl	H	H	H	m-tolyl	1-naphthyl	H
T-163	m-tolyl	H	H	H	m-tolyl	H	1-naphthyl
T-164	m-tolyl	H	H	H	m-tolyl	2-naphthyl	H
T-165	m-tolyl	H	H	H	m-tolyl	H	2-naphthyl
T-166	m-tolyl	H	H	H	m-tolyl	o-biphenyl	H
T-167	m-tolyl	H	H	H	m-tolyl	H	o-biphenyl
T-168	m-tolyl	H	H	H	m-tolyl	m-biphenyl	H
T-169	m-tolyl	H	H	H	m-tolyl	H	m-biphenyl
T-170	m-tolyl	H	H	H	m-tolyl	p-biphenyl	H
T-171	m-tolyl	H	H	H	m-tolyl	H	p-biphenyl
T-172	m-tolyl	H	H	H	m-tolyl	m-tolyl	H
T-173	m-tolyl	H	H	H	m-tolyl	H	m-tolyl
T-174	p-tolyl	H	H	H	p-tolyl	H	H
T-175	p-tolyl	Ph	H	Ph	p-tolyl	H	H
T-176	p-tolyl	H	Ph	H	p-tolyl	H	H
T-177	p-tolyl	H	H	H	p-tolyl	Ph	H
T-178	p-tolyl	H	H	H	p-tolyl	H	Ph
T-179	p-tolyl	H	H	H	p-tolyl	1-naphthyl	H
T-180	p-tolyl	H	H	H	p-tolyl	H	1-naphthyl
T-181	p-tolyl	H	H	H	p-tolyl	2-naphthyl	H
T-182	p-tolyl	H	H	H	p-tolyl	H	2-naphthyl
T-183	p-tolyl	H	H	H	p-tolyl	o-biphenyl	H
T-184	p-tolyl	H	H	H	p-tolyl	H	o-biphenyl
T-185	p-tolyl	H	H	H	p-tolyl	m-biphenyl	H
T-186	p-tolyl	H	H	H	p-tolyl	H	m-biphenyl
T-187	p-tolyl	H	H	H	p-tolyl	p-biphenyl	H
T-188	p-tolyl	H	H	H	p-tolyl	H	p-biphenyl
T-189	p-tolyl	H	H	H	p-tolyl	p-tolyl	H
T-190	p-tolyl	H	H	H	p-tolyl	H	p-tolyl

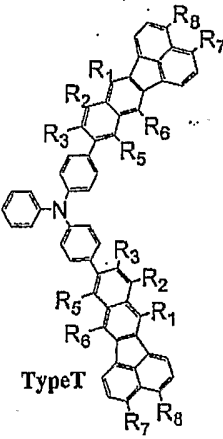
	R ₁	R ₂	R ₃	R ₅	R ₆	R ₇	R ₈	
 <p>Type I</p>	T-191	Ph	H	-CH ₃	H	Ph	H	
	T-192	1-naphtyl	H	-CH ₃	H	1-naphtyl	H	
	T-193	2-naphtyl	H	-CH ₃	H	2-naphtyl	H	
	T-194	o-biphenyl	H	-CH ₃	H	o-biphenyl	H	
	T-195	m-biphenyl	H	-CH ₃	H	m-biphenyl	H	
	T-196	p-biphenyl	H	-CH ₃	H	p-biphenyl	H	
	T-197	o-tolyl	H	-CH ₃	H	o-tolyl	H	
	T-198	m-tolyl	H	-CH ₃	H	m-tolyl	H	
	T-199	p-tolyl	H	-CH ₃	H	p-tolyl	H	
	T-200	Ph	H	H	H	Ph	-CH ₃	H
	T-201	1-naphtyl	H	H	H	1-naphtyl	-CH ₃	H
	T-202	2-naphtyl	H	H	H	2-naphtyl	-CH ₃	H
	T-203	o-biphenyl	H	H	H	o-biphenyl	-CH ₃	H
	T-204	m-biphenyl	H	H	H	m-biphenyl	-CH ₃	H
	T-205	p-biphenyl	H	H	H	p-biphenyl	-CH ₃	H
	T-206	o-tolyl	H	H	H	o-tolyl	-CH ₃	H
	T-207	m-tolyl	H	H	H	m-tolyl	-CH ₃	H
	T-208	p-tolyl	H	H	H	p-tolyl	-CH ₃	H
	T-209	Ph	H	H	H	Ph	H	-CH ₃
	T-210	1-naphtyl	H	H	H	1-naphtyl	H	-CH ₃
	T-211	2-naphtyl	H	H	H	2-naphtyl	H	-CH ₃
	T-212	o-biphenyl	H	H	H	o-biphenyl	H	-CH ₃
	T-213	m-biphenyl	H	H	H	m-biphenyl	H	-CH ₃
	T-214	p-biphenyl	H	H	H	p-biphenyl	H	-CH ₃
	T-215	o-tolyl	H	H	H	o-tolyl	H	-CH ₃
T-216	m-tolyl	H	H	H	m-tolyl	H	-CH ₃	
T-217	p-tolyl	H	H	H	p-tolyl	H	-CH ₃	
T-218	Ph	H	H	H	Ph	-CH ₃	-CH ₃	
T-219	1-naphtyl	H	H	H	1-naphtyl	-CH ₃	-CH ₃	
T-220	2-naphtyl	H	H	H	2-naphtyl	-CH ₃	-CH ₃	
T-221	o-biphenyl	H	H	H	o-biphenyl	-CH ₃	-CH ₃	
T-222	m-biphenyl	H	H	H	m-biphenyl	-CH ₃	-CH ₃	
T-223	p-biphenyl	H	H	H	p-biphenyl	-CH ₃	-CH ₃	
T-224	o-tolyl	H	H	H	o-tolyl	-CH ₃	-CH ₃	
T-225	m-tolyl	H	H	H	m-tolyl	-CH ₃	-CH ₃	
T-226	p-tolyl	H	H	H	p-tolyl	-CH ₃	-CH ₃	
T-227	Ph	H	H	H	Ph	H	DPA	
T-228	1-naphtyl	H	H	H	1-naphtyl	H	DPA	
T-229	2-naphtyl	H	H	H	2-naphtyl	H	DPA	
T-230	o-biphenyl	H	H	H	o-biphenyl	H	DPA	
T-231	m-biphenyl	H	H	H	m-biphenyl	H	DPA	
T-232	p-biphenyl	H	H	H	p-biphenyl	H	DPA	
T-233	Ph	H	H	H	Ph	DPA	H	
T-234	1-naphtyl	H	H	H	1-naphtyl	DPA	H	
T-235	2-naphtyl	H	H	H	2-naphtyl	DPA	H	
T-236	o-biphenyl	H	H	H	o-biphenyl	DPA	H	
T-237	m-biphenyl	H	H	H	m-biphenyl	DPA	H	
T-238	p-biphenyl	H	H	H	p-biphenyl	DPA	H	
T-239	Ph	H	H	H	Ph	H	TPA	
T-240	1-naphtyl	H	H	H	1-naphtyl	H	TPA	
T-241	2-naphtyl	H	H	H	2-naphtyl	H	TPA	
T-242	o-biphenyl	H	H	H	o-biphenyl	H	TPA	
T-243	m-biphenyl	H	H	H	m-biphenyl	H	TPA	
T-244	p-biphenyl	H	H	H	p-biphenyl	H	TPA	
T-245	Ph	H	H	H	Ph	TPA	H	
T-246	1-naphtyl	H	H	H	1-naphtyl	TPA	H	
T-247	2-naphtyl	H	H	H	2-naphtyl	TPA	H	
T-248	o-biphenyl	H	H	H	o-biphenyl	TPA	H	
T-249	m-biphenyl	H	H	H	m-biphenyl	TPA	H	
T-250	p-biphenyl	H	H	H	p-biphenyl	TPA	H	

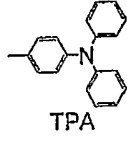
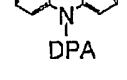
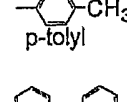
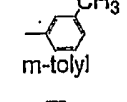
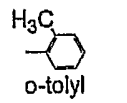
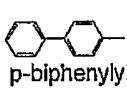
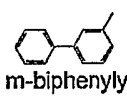
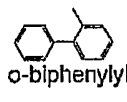
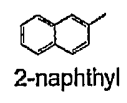
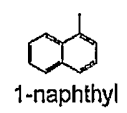

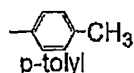
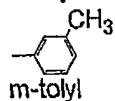
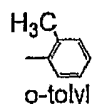
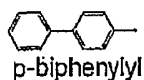
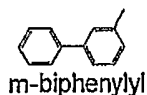
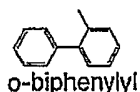
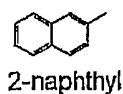
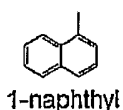
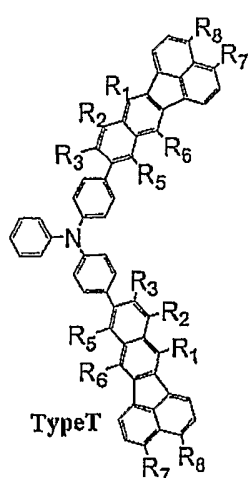

	R ₁	R ₂	R ₃	R ₅	R ₆	R ₇	R ₈
T-251	Ph	H	H	H	1-naphthyl	H	H
T-252	Ph	H	H	H	2-naphthyl	H	H
T-253	Ph	H	H	H	o-biphenyl	H	H
T-254	Ph	H	H	H	m-biphenyl	H	H
T-255	Ph	H	H	H	p-biphenyl	H	H
T-256	Ph	H	H	H	O-tolyl	H	H
T-257	Ph	H	H	H	m-tolyl	H	H
T-258	Ph	H	H	H	p-tolyl	H	H
T-259	1-naphthyl	H	H	H	2-naphthyl	H	H
T-260	1-naphthyl	H	H	H	o-biphenyl	H	H
T-261	1-naphthyl	H	H	H	m-biphenyl	H	H
T-262	1-naphthyl	H	H	H	p-biphenyl	H	H
T-263	1-naphthyl	H	H	H	O-tolyl	H	H
T-264	1-naphthyl	H	H	H	m-tolyl	H	H
T-265	1-naphthyl	H	H	H	p-tolyl	H	H
T-266	2-naphthyl	H	H	H	o-biphenyl	H	H
T-267	2-naphthyl	H	H	H	m-biphenyl	H	H
T-268	2-naphthyl	H	H	H	p-biphenyl	H	H
T-269	2-naphthyl	H	H	H	O-tolyl	H	H
T-270	2-naphthyl	H	H	H	m-tolyl	H	H
T-271	2-naphthyl	H	H	H	p-tolyl	H	H
T-272	o-biphenyl	H	H	H	m-biphenyl	H	H
T-273	o-biphenyl	H	H	H	p-biphenyl	H	H
T-274	o-biphenyl	H	H	H	O-tolyl	H	H
T-275	o-biphenyl	H	H	H	m-tolyl	H	H
T-276	o-biphenyl	H	H	H	p-tolyl	H	H
T-277	m-biphenyl	H	H	H	p-biphenyl	H	H
T-278	m-biphenyl	H	H	H	O-tolyl	H	H
T-279	m-biphenyl	H	H	H	m-tolyl	H	H
T-280	m-biphenyl	H	H	H	p-tolyl	H	H
T-281	p-biphenyl	H	H	H	O-tolyl	H	H
T-282	p-biphenyl	H	H	H	m-tolyl	H	H
T-283	p-biphenyl	H	H	H	p-tolyl	H	H
T-284	O-tolyl	H	H	H	m-tolyl	H	H
T-285	O-tolyl	H	H	H	p-tolyl	H	H
T-286	m-tolyl	H	H	H	p-tolyl	H	H

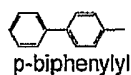
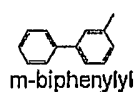
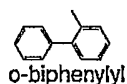
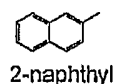
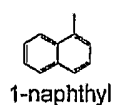
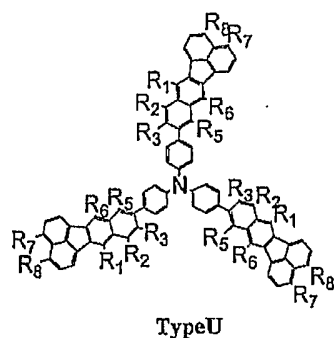

	R ₁	R ₂	R ₃	R ₅	R ₆	R ₇	R ₈
U-1	H	H	H	H	H	H	H
U-2	Ph	H	H	H	Ph	H	H
U-3	Ph	Ph	H	H	Ph	H	H
U-4	Ph	H	H	Ph	Ph	H	H
U-5	Ph	Ph	H	Ph	Ph	H	H
U-6	Ph	H	Ph	H	Ph	H	H
U-7	Ph	H	H	H	Ph	Ph	H
U-8	Ph	H	H	H	Ph	H	Ph
U-9	Ph	H	H	H	Ph	Ph	Ph
U-10	Ph	H	H	H	Ph	1-naphthyl	H
U-11	Ph	H	H	H	Ph	H	1-naphthyl
U-12	Ph	H	H	H	Ph	1-naphthyl	1-naphthyl
U-13	Ph	H	H	H	Ph	2-naphthyl	H
U-14	Ph	H	H	H	Ph	H	2-naphthyl
U-15	Ph	H	H	H	Ph	2-naphthyl	2-naphthyl
U-16	Ph	H	H	H	Ph	o-biphenyl	H
U-17	Ph	H	H	H	Ph	H	o-biphenyl
U-18	Ph	H	H	H	Ph	o-biphenyl	o-biphenyl
U-19	Ph	H	H	H	Ph	m-biphenyl	H
U-20	Ph	H	H	H	Ph	H	m-biphenyl
U-21	Ph	H	H	H	Ph	m-biphenyl	m-biphenyl
U-22	Ph	H	H	H	Ph	p-biphenyl	H
U-23	Ph	H	H	H	Ph	H	p-biphenyl
U-24	Ph	H	H	H	Ph	p-biphenyl	p-biphenyl
U-25	1-naphthyl	H	H	H	1-naphthyl	H	H
U-26	1-naphthyl	Ph	H	H	1-naphthyl	H	H
U-27	1-naphthyl	H	H	Ph	1-naphthyl	H	H
U-28	1-naphthyl	Ph	H	Ph	1-naphthyl	H	H
U-29	1-naphthyl	H	Ph	H	1-naphthyl	H	H
U-30	1-naphthyl	H	H	H	1-naphthyl	Ph	H
U-31	1-naphthyl	H	H	H	1-naphthyl	H	Ph
U-32	1-naphthyl	H	H	H	1-naphthyl	Ph	Ph
U-33	1-naphthyl	H	H	H	1-naphthyl	1-naphthyl	H
U-34	1-naphthyl	H	H	H	1-naphthyl	H	1-naphthyl
U-35	1-naphthyl	H	H	H	1-naphthyl	1-naphthyl	1-naphthyl
U-36	1-naphthyl	H	H	H	1-naphthyl	2-naphthyl	H
U-37	1-naphthyl	H	H	H	1-naphthyl	H	2-naphthyl
U-38	1-naphthyl	H	H	H	1-naphthyl	2-naphthyl	2-naphthyl
U-39	1-naphthyl	H	H	H	1-naphthyl	o-biphenyl	H
U-40	1-naphthyl	H	H	H	1-naphthyl	H	o-biphenyl
U-41	1-naphthyl	H	H	H	1-naphthyl	o-biphenyl	o-biphenyl
U-42	1-naphthyl	H	H	H	1-naphthyl	m-biphenyl	H
U-43	1-naphthyl	H	H	H	1-naphthyl	H	m-biphenyl
U-44	1-naphthyl	H	H	H	1-naphthyl	m-biphenyl	m-biphenyl
U-45	1-naphthyl	H	H	H	1-naphthyl	p-biphenyl	H
U-46	1-naphthyl	H	H	H	1-naphthyl	H	p-biphenyl
U-47	1-naphthyl	H	H	H	1-naphthyl	p-biphenyl	p-biphenyl

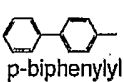
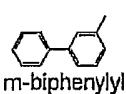
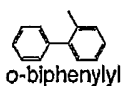
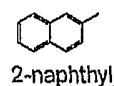
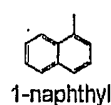
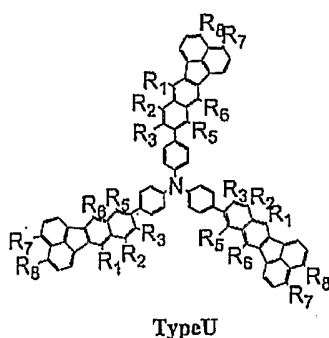

	R ₁	R ₂	R ₃	R ₅	R ₆	R ₇	R ₈
U-48	2-naphthyl	H	H	H	2-naphthyl	H	H
U-49	2-naphthyl	Ph	H	H	2-naphthyl	H	H
U-50	2-naphthyl	H	H	Ph	2-naphthyl	H	H
U-51	2-naphthyl	Ph	H	Ph	2-naphthyl	H	H
U-52	2-naphthyl	H	Ph	H	2-naphthyl	H	H
U-53	2-naphthyl	H	H	H	2-naphthyl	Ph	H
U-54	2-naphthyl	H	H	H	2-naphthyl	H	Ph
U-55	2-naphthyl	H	H	H	2-naphthyl	Ph	Ph
U-56	2-naphthyl	H	H	H	2-naphthyl	1-naphthyl	H
U-57	2-naphthyl	H	H	H	2-naphthyl	H	1-naphthyl
U-58	2-naphthyl	H	H	H	2-naphthyl	1-naphthyl	1-naphthyl
U-59	2-naphthyl	H	H	H	2-naphthyl	2-naphthyl	H
U-60	2-naphthyl	H	H	H	2-naphthyl	H	2-naphthyl
U-61	2-naphthyl	H	H	H	2-naphthyl	2-naphthyl	2-naphthyl
U-62	2-naphthyl	H	H	H	2-naphthyl	o-biphenyl	H
U-63	2-naphthyl	H	H	H	2-naphthyl	H	o-biphenyl
U-64	2-naphthyl	H	H	H	2-naphthyl	o-biphenyl	o-biphenyl
U-65	2-naphthyl	H	H	H	2-naphthyl	m-biphenyl	H
U-66	2-naphthyl	H	H	H	2-naphthyl	H	m-biphenyl
U-67	2-naphthyl	H	H	H	2-naphthyl	m-biphenyl	m-biphenyl
U-68	2-naphthyl	H	H	H	2-naphthyl	p-biphenyl	H
U-69	2-naphthyl	H	H	H	2-naphthyl	H	p-biphenyl
U-70	2-naphthyl	H	H	H	2-naphthyl	p-biphenyl	p-biphenyl
U-71	o-biphenyl	H	H	H	o-biphenyl	H	H
U-72	o-biphenyl	Ph	H	H	o-biphenyl	H	H
U-73	o-biphenyl	H	H	Ph	o-biphenyl	H	H
U-74	o-biphenyl	Ph	H	Ph	o-biphenyl	H	H
U-75	o-biphenyl	H	Ph	H	o-biphenyl	H	H
U-76	o-biphenyl	H	H	H	o-biphenyl	Ph	H
U-77	o-biphenyl	H	H	H	o-biphenyl	H	Ph
U-78	o-biphenyl	H	H	H	o-biphenyl	Ph	Ph
U-79	o-biphenyl	H	H	H	o-biphenyl	1-naphthyl	H
U-80	o-biphenyl	H	H	H	o-biphenyl	H	1-naphthyl
U-81	o-biphenyl	H	H	H	o-biphenyl	1-naphthyl	1-naphthyl
U-82	o-biphenyl	H	H	H	o-biphenyl	2-naphthyl	H
U-83	o-biphenyl	H	H	H	o-biphenyl	H	2-naphthyl
U-84	o-biphenyl	H	H	H	o-biphenyl	2-naphthyl	2-naphthyl
U-85	o-biphenyl	H	H	H	o-biphenyl	o-biphenyl	H
U-86	o-biphenyl	H	H	H	o-biphenyl	H	o-biphenyl
U-87	o-biphenyl	H	H	H	o-biphenyl	o-biphenyl	o-biphenyl
U-88	o-biphenyl	H	H	H	o-biphenyl	m-biphenyl	H
U-89	o-biphenyl	H	H	H	o-biphenyl	H	m-biphenyl
U-90	o-biphenyl	H	H	H	o-biphenyl	m-biphenyl	m-biphenyl
U-91	o-biphenyl	H	H	H	o-biphenyl	p-biphenyl	H
U-92	o-biphenyl	H	H	H	o-biphenyl	H	p-biphenyl
U-93	o-biphenyl	H	H	H	o-biphenyl	p-biphenyl	p-biphenyl

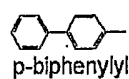
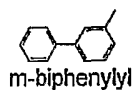
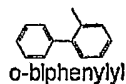
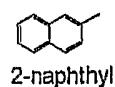
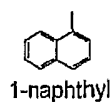
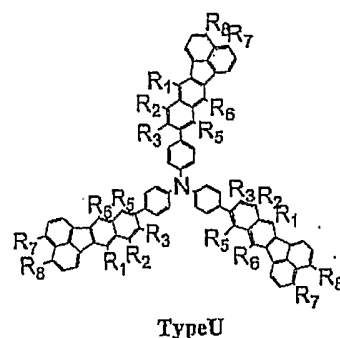

	R ₁	R ₂	R ₃	R ₅	R ₆	R ₇	R ₈
U-94	m-biphenyl	H	H	H	m-biphenyl	H	H
U-95	m-biphenyl	Ph	H	H	m-biphenyl	H	H
U-96	m-biphenyl	H	H	Ph	m-biphenyl	H	H
U-97	m-biphenyl	Ph	H	Ph	m-biphenyl	H	H
U-98	m-biphenyl	H	Ph	H	m-biphenyl	H	H
U-99	m-biphenyl	H	H	H	m-biphenyl	Ph	H
U-100	m-biphenyl	H	H	H	m-biphenyl	H	Ph
U-101	m-biphenyl	H	H	H	m-biphenyl	Ph	Ph
U-102	m-biphenyl	H	H	H	m-biphenyl	1-naphthyl	H
U-103	m-biphenyl	H	H	H	m-biphenyl	H	1-naphthyl
U-104	m-biphenyl	H	H	H	m-biphenyl	1-naphthyl	1-naphthyl
U-105	m-biphenyl	H	H	H	m-biphenyl	2-naphthyl	H
U-106	m-biphenyl	H	H	H	m-biphenyl	H	2-naphthyl
U-107	m-biphenyl	H	H	H	m-biphenyl	2-naphthyl	2-naphthyl
U-108	m-biphenyl	H	H	H	m-biphenyl	o-biphenyl	H
U-109	m-biphenyl	H	H	H	m-biphenyl	H	o-biphenyl
U-110	m-biphenyl	H	H	H	m-biphenyl	o-biphenyl	o-biphenyl
U-111	m-biphenyl	H	H	H	m-biphenyl	m-biphenyl	H
U-112	m-biphenyl	H	H	H	m-biphenyl	H	m-biphenyl
U-113	m-biphenyl	H	H	H	m-biphenyl	m-biphenyl	m-biphenyl
U-114	m-biphenyl	H	H	H	m-biphenyl	p-biphenyl	H
U-115	m-biphenyl	H	H	H	m-biphenyl	H	p-biphenyl
U-116	m-biphenyl	H	H	H	m-biphenyl	p-biphenyl	p-biphenyl
U-117	p-biphenyl	H	H	H	p-biphenyl	H	H
U-118	p-biphenyl	Ph	H	H	p-biphenyl	H	H
U-119	p-biphenyl	H	H	Ph	p-biphenyl	H	H
U-120	p-biphenyl	Ph	H	Ph	p-biphenyl	H	H
U-121	p-biphenyl	H	Ph	H	p-biphenyl	H	H
U-122	p-biphenyl	H	H	H	p-biphenyl	Ph	H
U-123	p-biphenyl	H	H	H	p-biphenyl	H	Ph
U-124	p-biphenyl	H	H	H	p-biphenyl	Ph	Ph
U-125	p-biphenyl	H	H	H	p-biphenyl	1-naphthyl	H
U-126	p-biphenyl	H	H	H	p-biphenyl	H	1-naphthyl
U-127	p-biphenyl	H	H	H	p-biphenyl	1-naphthyl	1-naphthyl
U-128	p-biphenyl	H	H	H	p-biphenyl	2-naphthyl	H
U-129	p-biphenyl	H	H	H	p-biphenyl	H	2-naphthyl
U-130	p-biphenyl	H	H	H	p-biphenyl	2-naphthyl	2-naphthyl
U-131	p-biphenyl	H	H	H	p-biphenyl	o-biphenyl	H
U-132	p-biphenyl	H	H	H	p-biphenyl	H	o-biphenyl
U-133	p-biphenyl	H	H	H	p-biphenyl	o-biphenyl	o-biphenyl
U-134	p-biphenyl	H	H	H	p-biphenyl	m-biphenyl	H
U-135	p-biphenyl	H	H	H	p-biphenyl	H	m-biphenyl
U-136	p-biphenyl	H	H	H	p-biphenyl	m-biphenyl	m-biphenyl
U-137	p-biphenyl	H	H	H	p-biphenyl	p-biphenyl	H
U-138	p-biphenyl	H	H	H	p-biphenyl	H	p-biphenyl
U-139	p-biphenyl	H	H	H	p-biphenyl	p-biphenyl	p-biphenyl

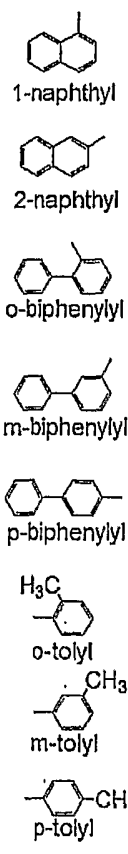
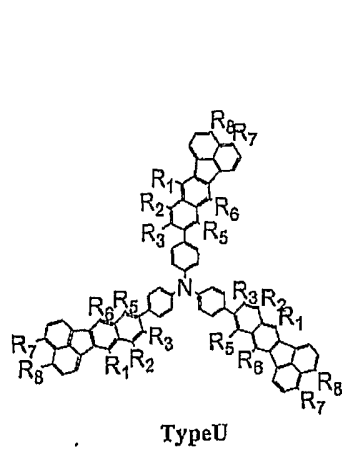

	R ₁	R ₂	R ₃	R ₅	R ₆	R ₇	R ₈
U-140	o-tolyl	H	H	H	o-tolyl	H	H
U-141	o-tolyl	Ph	H	Ph	o-tolyl	H	H
U-142	o-tolyl	H	Ph	H	o-tolyl	H	H
U-143	o-tolyl	H	H	H	o-tolyl	Ph	H
U-144	o-tolyl	H	H	H	o-tolyl	H	Ph
U-145	o-tolyl	H	H	H	o-tolyl	1-naphthyl	H
U-146	o-tolyl	H	H	H	o-tolyl	H	1-naphthyl
U-147	o-tolyl	H	H	H	o-tolyl	2-naphthyl	H
U-148	o-tolyl	H	H	H	o-tolyl	H	2-naphthyl
U-149	o-tolyl	H	H	H	o-tolyl	o-biphenyl	H
U-150	o-tolyl	H	H	H	o-tolyl	H	o-biphenyl
U-151	o-tolyl	H	H	H	o-tolyl	m-biphenyl	H
U-152	o-tolyl	H	H	H	o-tolyl	H	m-biphenyl
U-153	o-tolyl	H	H	H	o-tolyl	p-biphenyl	H
U-154	o-tolyl	H	H	H	o-tolyl	H	p-biphenyl
U-155	o-tolyl	H	H	H	o-tolyl	o-tolyl	H
U-156	o-tolyl	H	H	H	o-tolyl	H	o-tolyl
U-157	m-tolyl	H	H	H	m-tolyl	H	H
U-158	m-tolyl	Ph	H	Ph	m-tolyl	H	H
U-159	m-tolyl	H	Ph	H	m-tolyl	H	H
U-160	m-tolyl	H	H	H	m-tolyl	Ph	H
U-161	m-tolyl	H	H	H	m-tolyl	H	Ph
U-162	m-tolyl	H	H	H	m-tolyl	1-naphthyl	H
U-163	m-tolyl	H	H	H	m-tolyl	H	1-naphthyl
U-164	m-tolyl	H	H	H	m-tolyl	2-naphthyl	H
U-165	m-tolyl	H	H	H	m-tolyl	H	2-naphthyl
U-166	m-tolyl	H	H	H	m-tolyl	o-biphenyl	H
U-167	m-tolyl	H	H	H	m-tolyl	H	o-biphenyl
U-168	m-tolyl	H	H	H	m-tolyl	m-biphenyl	H
U-169	m-tolyl	H	H	H	m-tolyl	H	m-biphenyl
U-170	m-tolyl	H	H	H	m-tolyl	p-biphenyl	H
U-171	m-tolyl	H	H	H	m-tolyl	H	p-biphenyl
U-172	m-tolyl	H	H	H	m-tolyl	m-tolyl	H
U-173	m-tolyl	H	H	H	m-tolyl	H	m-tolyl
U-174	p-tolyl	H	H	H	p-tolyl	H	H
U-175	p-tolyl	Ph	H	Ph	p-tolyl	H	H
U-176	p-tolyl	H	Ph	H	p-tolyl	H	H
U-177	p-tolyl	H	H	H	p-tolyl	Ph	H
U-178	p-tolyl	H	H	H	p-tolyl	H	Ph
U-179	p-tolyl	H	H	H	p-tolyl	1-naphthyl	H
U-180	p-tolyl	H	H	H	p-tolyl	H	1-naphthyl
U-181	p-tolyl	H	H	H	p-tolyl	2-naphthyl	H
U-182	p-tolyl	H	H	H	p-tolyl	H	2-naphthyl
U-183	p-tolyl	H	H	H	p-tolyl	o-biphenyl	H
U-184	p-tolyl	H	H	H	p-tolyl	H	o-biphenyl
U-185	p-tolyl	H	H	H	p-tolyl	m-biphenyl	H
U-186	p-tolyl	H	H	H	p-tolyl	H	m-biphenyl
U-187	p-tolyl	H	H	H	p-tolyl	p-biphenyl	H
U-188	p-tolyl	H	H	H	p-tolyl	H	p-biphenyl
U-189	p-tolyl	H	H	H	p-tolyl	p-tolyl	H
U-190	p-tolyl	H	H	H	p-tolyl	H	p-tolyl

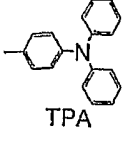
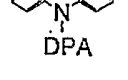
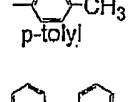
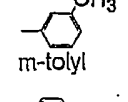
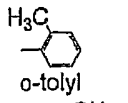
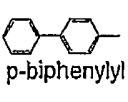
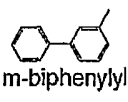
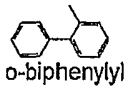
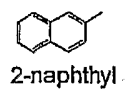
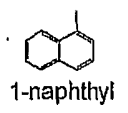
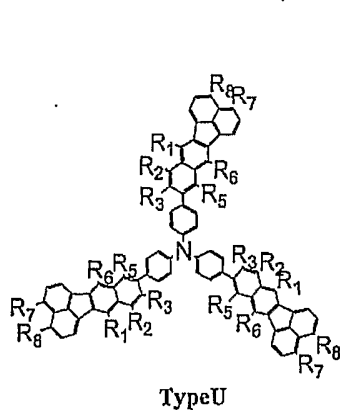

	R ₁	R ₂	R ₃	R ₅	R ₆	R ₇	R ₈
U-191	Ph	H	-CH ₃	H	Ph	H	H
U-192	1-naphthyl	H	-CH ₃	H	1-naphthyl	H	H
U-193	2-naphthyl	H	-CH ₃	H	2-naphthyl	H	H
U-194	o-biphenyl	H	-CH ₃	H	o-biphenyl	H	H
U-195	m-biphenyl	H	-CH ₃	H	m-biphenyl	H	H
U-196	p-biphenyl	H	-CH ₃	H	p-biphenyl	H	H
U-197	o-tolyl	H	-CH ₃	H	o-tolyl	H	H
U-198	m-tolyl	H	-CH ₃	H	m-tolyl	H	H
U-199	p-tolyl	H	-CH ₃	H	p-tolyl	H	H
U-200	Ph	H	H	H	Ph	-CH ₃	H
U-201	1-naphthyl	H	H	H	1-naphthyl	-CH ₃	H
U-202	2-naphthyl	H	H	H	2-naphthyl	-CH ₃	H
U-203	o-biphenyl	H	H	H	o-biphenyl	-CH ₃	H
U-204	m-biphenyl	H	H	H	m-biphenyl	-CH ₃	H
U-205	p-biphenyl	H	H	H	p-biphenyl	-CH ₃	H
U-206	o-tolyl	H	H	H	o-tolyl	-CH ₃	H
U-207	m-tolyl	H	H	H	m-tolyl	-CH ₃	H
U-208	p-tolyl	H	H	H	p-tolyl	-CH ₃	H
U-209	Ph	H	H	H	Ph	H	-CH ₃
U-210	1-naphthyl	H	H	H	1-naphthyl	H	-CH ₃
U-211	2-naphthyl	H	H	H	2-naphthyl	H	-CH ₃
U-212	o-biphenyl	H	H	H	o-biphenyl	H	-CH ₃
U-213	m-biphenyl	H	H	H	m-biphenyl	H	-CH ₃
U-214	p-biphenyl	H	H	H	p-biphenyl	H	-CH ₃
U-215	o-tolyl	H	H	H	o-tolyl	H	-CH ₃
U-216	m-tolyl	H	H	H	m-tolyl	H	-CH ₃
U-217	p-tolyl	H	H	H	p-tolyl	H	-CH ₃
U-218	Ph	H	H	H	Ph	-CH ₃	-CH ₃
U-219	1-naphthyl	H	H	H	1-naphthyl	-CH ₃	-CH ₃
U-220	2-naphthyl	H	H	H	2-naphthyl	-CH ₃	-CH ₃
U-221	o-biphenyl	H	H	H	o-biphenyl	-CH ₃	-CH ₃
U-222	m-biphenyl	H	H	H	m-biphenyl	-CH ₃	-CH ₃
U-223	p-biphenyl	H	H	H	p-biphenyl	-CH ₃	-CH ₃
U-224	o-tolyl	H	H	H	o-tolyl	-CH ₃	-CH ₃
U-225	m-tolyl	H	H	H	m-tolyl	-CH ₃	-CH ₃
U-226	p-tolyl	H	H	H	p-tolyl	-CH ₃	-CH ₃
U-227	Ph	H	H	H	Ph	H	DPA
U-228	1-naphthyl	H	H	H	1-naphthyl	H	DPA
U-229	2-naphthyl	H	H	H	2-naphthyl	H	DPA
U-230	o-biphenyl	H	H	H	o-biphenyl	H	DPA
U-231	m-biphenyl	H	H	H	m-biphenyl	H	DPA
U-232	p-biphenyl	H	H	H	p-biphenyl	H	DPA
U-233	Ph	H	H	H	Ph	DPA	H
U-234	1-naphthyl	H	H	H	1-naphthyl	DPA	H
U-235	2-naphthyl	H	H	H	2-naphthyl	DPA	H
U-236	o-biphenyl	H	H	H	o-biphenyl	DPA	H
U-237	m-biphenyl	H	H	H	m-biphenyl	DPA	H
U-238	p-biphenyl	H	H	H	p-biphenyl	DPA	H
U-239	Ph	H	H	H	Ph	H	TPA
U-240	1-naphthyl	H	H	H	1-naphthyl	H	TPA
U-241	2-naphthyl	H	H	H	2-naphthyl	H	TPA
U-242	o-biphenyl	H	H	H	o-biphenyl	H	TPA
U-243	m-biphenyl	H	H	H	m-biphenyl	H	TPA
U-244	p-biphenyl	H	H	H	p-biphenyl	H	TPA
U-245	Ph	H	H	H	Ph	TPA	H
U-246	1-naphthyl	H	H	H	1-naphthyl	TPA	H
U-247	2-naphthyl	H	H	H	2-naphthyl	TPA	H
U-248	o-biphenyl	H	H	H	o-biphenyl	TPA	H
U-249	m-biphenyl	H	H	H	m-biphenyl	TPA	H
U-250	p-biphenyl	H	H	H	p-biphenyl	TPA	H

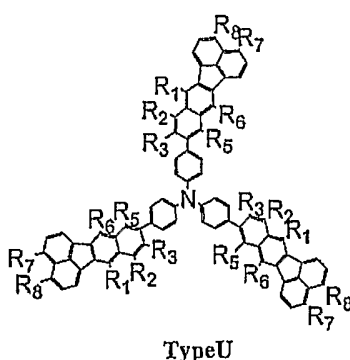
	R ₁	R ₂	R ₃	R ₅	R ₆	R ₇	R ₈	
 <p>Type U</p>	U-251	Ph	H	H	H	1-naphthyl	H	H
	U-252	Ph	H	H	H	2-naphthyl	H	H
	U-253	Ph	H	H	H	o-biphenyl	H	H
	U-254	Ph	H	H	H	m-biphenyl	H	H
	U-255	Ph	H	H	H	p-biphenyl	H	H
	U-256	Ph	H	H	H	O-tolyl	H	H
	U-257	Ph	H	H	H	m-tolyl	H	H
	U-258	Ph	H	H	H	p-tolyl	H	H
	U-259	1-naphthyl	H	H	H	2-naphthyl	H	H
	U-260	1-naphthyl	H	H	H	o-biphenyl	H	H
	U-261	1-naphthyl	H	H	H	m-biphenyl	H	H
	U-262	1-naphthyl	H	H	H	p-biphenyl	H	H
	U-263	1-naphthyl	H	H	H	O-tolyl	H	H
	U-264	1-naphthyl	H	H	H	m-tolyl	H	H
	U-265	1-naphthyl	H	H	H	p-tolyl	H	H
	U-266	2-naphthyl	H	H	H	o-biphenyl	H	H
	U-267	2-naphthyl	H	H	H	m-biphenyl	H	H
	U-268	2-naphthyl	H	H	H	p-biphenyl	H	H
	U-269	2-naphthyl	H	H	H	O-tolyl	H	H
	U-270	2-naphthyl	H	H	H	m-tolyl	H	H
	U-271	2-naphthyl	H	H	H	p-tolyl	H	H
	U-272	o-biphenyl	H	H	H	m-biphenyl	H	H
	U-273	o-biphenyl	H	H	H	p-biphenyl	H	H
	U-274	o-biphenyl	H	H	H	O-tolyl	H	H
	U-275	o-biphenyl	H	H	H	m-tolyl	H	H
	U-276	o-biphenyl	H	H	H	p-tolyl	H	H
U-277	m-biphenyl	H	H	H	p-biphenyl	H	H	
U-278	m-biphenyl	H	H	H	O-tolyl	H	H	
U-279	m-biphenyl	H	H	H	m-tolyl	H	H	
U-280	m-biphenyl	H	H	H	p-tolyl	H	H	
U-281	p-biphenyl	H	H	H	O-tolyl	H	H	
U-282	p-biphenyl	H	H	H	m-tolyl	H	H	
U-283	p-biphenyl	H	H	H	p-tolyl	H	H	
U-284	O-tolyl	H	H	H	m-tolyl	H	H	
U-285	O-tolyl	H	H	H	p-tolyl	H	H	
U-286	m-tolyl	H	H	H	p-tolyl	H	H	

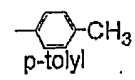
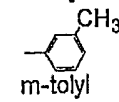
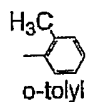
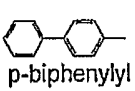
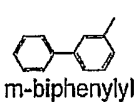
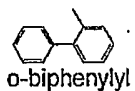
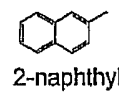
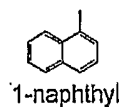

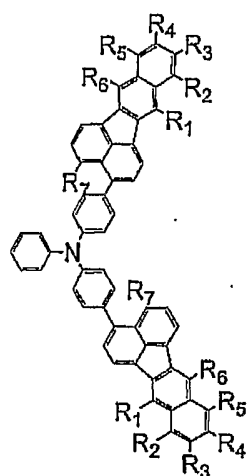

Type V

	R ₁	R ₂	R ₃	R ₄	R ₅	R ₆	R ₇
V-1	H	H	H	H	H	H	H
V-2	Ph	H	H	H	H	Ph	H
V-3	Ph	Ph	H	H	Ph	Ph	H
V-4	Ph	H	Ph	Ph	H	Ph	H
V-5	Ph	H	Ph	H	H	Ph	H
V-6	Ph	H	H	H	H	Ph	Ph
V-7	Ph	Me	H	H	Me	Ph	H
V-8	Ph	H	Me	Me	H	Ph	H
V-9	Ph	H	H	H	H	Ph	Me
V-10		H	H	H	H		H
V-11		Ph	H	H	Ph		H
V-12		H	Ph	Ph	H		H
V-13		H	Ph	H	H		H
V-14		H	H	H	H		Ph
V-15		Me	H	H	Me		H
V-16		H	Me	Me	H		H
V-17		H	H	H	H		Me
V-18		H	H	H	H		H
V-19		Ph	H	H	Ph		H
V-20		H	Ph	Ph	H		H
V-21		H	Ph	H	H		H
V-22		H	H	H	H		Ph
V-23		Me	H	H	Me		H
V-24		H	Me	Me	H		H
V-25		H	H	H	H		Me

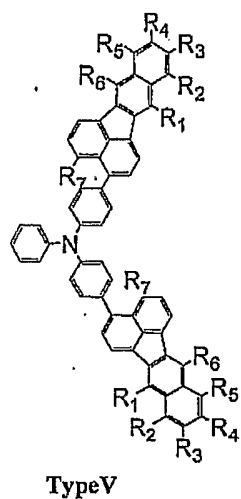

	R ₁	R ₂	R ₃	R ₄	R ₅	R ₆	R ₇
V-26		H	H	H	H		H
V-27		Ph	H	H	Ph		H
V-28		H	Ph	Ph	H		H
V-29		H	Ph	H	H		H
V-30		H	H	H	H		Ph
V-31		Me	H	H	Me		H
V-32		H	Me	Me	H		H
V-33		H	H	H	H		Me
V-34		H	H	H	H		H
V-35		Ph	H	H	Ph		H
V-36		H	Ph	Ph	H		H
V-37		H	Ph	H	H		H
V-38		H	H	H	H		Ph
V-39		Me	H	H	Me		H
V-40		H	Me	Me	H		H
V-41		H	H	H	H		Me
V-42		H	H	H	H		H
V-43		Ph	H	H	Ph		H
V-44		H	Ph	Ph	H		H
V-45		H	Ph	H	H		H
V-46		H	H	H	H		Ph
V-47		Me	H	H	Me		H
V-48		H	Me	Me	H		H
V-49		H	H	H	H		Me

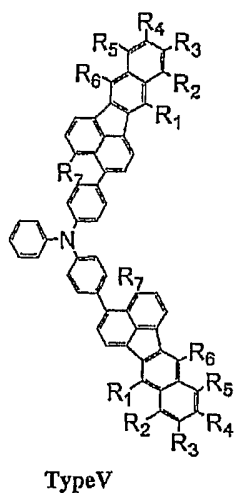

Type V

	R ₁	R ₂	R ₃	R ₄	R ₅	R ₆	R ₇
V-50	Ph	H	H	H	H		H
V-51	Ph	H	H	H	H		H
V-52	Ph	H	H	H	H		H
V-53	Ph	H	H	H	H		H
V-54	Ph	H	H	H	H		H
V-55		H	H	H	H		H
V-56		H	H	H	H		H
V-57		H	H	H	H		H
V-58		H	H	H	H		H
V-59		H	H	H	H		H
V-60		H	H	H	H		H
V-61		H	H	H	H		H
V-62		H	H	H	H		H
V-63		H	H	H	H		H
V-64		H	H	H	H		H
V-65	H	Ph	H	H	Ph	H	H
V-66	H		H	H		H	H
V-67	H		H	H		H	H
V-68	H		H	H		H	H
V-69	H		H	H		H	H
V-70	H		H	H		H	H
V-71	H	H			H	H	H
V-72	H	H			H	H	H
V-73	H	H			H	H	H
V-74	H	H			H	H	H
V-75	H	H			H	H	H

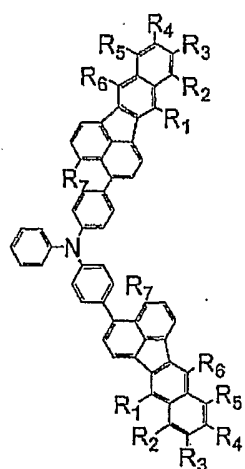

Type V

	R ₁	R ₂	R ₃	R ₄	R ₅	R ₆	R ₇
V-76	H ₃ C-	H	H	H	H	H ₃ C-	H
V-77	H ₃ C-	Ph	H	H	Ph	H ₃ C-	H
V-78	H ₃ C-	H	Ph	Ph	H	H ₃ C-	H
V-79	H ₃ C-	H	Ph	H	H	H ₃ C-	H
V-80	H ₃ C-	H	H	H	H	H ₃ C-	Ph
V-81	H ₃ C-	Me	H	H	Me	H ₃ C-	H
V-82	H ₃ C-	H	Me	Me	H	H ₃ C-	H
V-83	H ₃ C-	H	H	H	H	H ₃ C-	Me
V-84	H ₃ C-	H	H	H	H	H ₃ C-	H
V-85	H ₃ C-	Ph	H	H	Ph	H ₃ C-	H
V-86	H ₃ C-	H	Ph	Ph	H	H ₃ C-	H
V-87	H ₃ C-	H	Ph	H	H	H ₃ C-	H
V-88	H ₃ C-	H	H	H	H	H ₃ C-	Ph
V-89	H ₃ C-	Me	H	H	Me	H ₃ C-	H
V-90	H ₃ C-	H	Me	Me	H	H ₃ C-	H
V-91	H ₃ C-	H	H	H	H	H ₃ C-	Me
V-92	H ₃ C-	H	H	H	H	H ₃ C-	H
V-93	H ₃ C-	Ph	H	H	Ph	H ₃ C-	H
V-94	H ₃ C-	H	Ph	Ph	H	H ₃ C-	H
V-96	H ₃ C-	H	Ph	H	H	H ₃ C-	H
V-96	H ₃ C-	H	H	H	H	H ₃ C-	Ph
V-97	H ₃ C-	Me	H	H	Me	H ₃ C-	H
V-98	H ₃ C-	H	Me	Me	H	H ₃ C-	H
V-99	H ₃ C-	H	H	H	H	H ₃ C-	Me

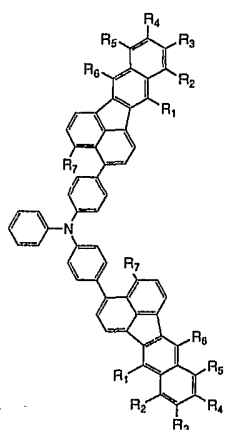

Type V

	R ₁	R ₂	R ₃	R ₄	R ₅	R ₆	R ₇
100		H	H	H	H		H
101		Ph	H	H	Ph		H
102		H	Ph	Ph	H		H
103		H	Ph	H	H		H
104		H	H	H	H		Ph
105		Me	H	H	Me		H
106		H	Me	Me	H		H
107		H	H	H	H		Me
108		H	H	H	H		H
109		Ph	H	H	Ph		H
110		H	Ph	Ph	H		H
111		H	Ph	H	H		H
112		H	H	H	H		Ph
113		Me	H	H	Me		H
114		H	Me	Me	H		H
115		H	H	H	H		Me
116		H	H	H	H		H
117		Ph	H	H	Ph		H
118		H	Ph	Ph	H		H
119		H	Ph	H	H		H
120		H	H	H	H		Ph
121		Me	H	H	Me		H
122		H	Me	Me	H		H
123		H	H	H	H		Me

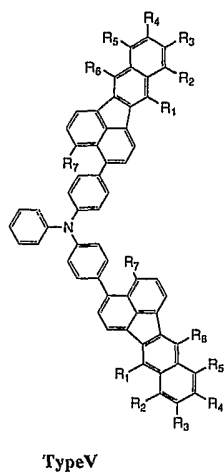

	R ₁	R ₂	R ₃	R ₄	R ₅	R ₆	R ₇
124		H	H	H	H		H
125		Ph	H	H	Ph		H
126		H	Ph	Ph	H		H
127		H	Ph	H	H		H
128		H	H	H	H		Ph
129		Me	H	H	Me		H
130		H	Me	Me	H		H
131		H	H	H	H		Me
132		H	H	H	H		H
133		Ph	H	H	Ph		H
134		H	Ph	Ph	H		H
135		H	Ph	H	H		H
136		H	H	H	H		Ph
137		Me	H	H	Me		H
138		H	Me	Me	H		H
139		H	H	H	H		Me
140		H	H	H	H		H
141		Ph	H	H	Ph		H
142		H	Ph	Ph	H		H
143		H	Ph	H	H		H
144		H	H	H	H		Ph
145		Me	H	H	Me		H
146		H	Me	Me	H		H
147		H	H	H	H		Me

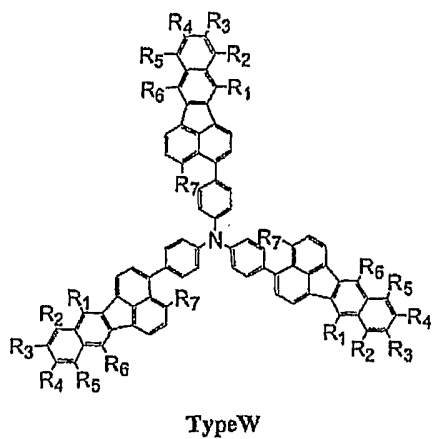

	R ₁	R ₂	R ₃	R ₄	R ₅	R ₆	R ₇
W-1	H	H	H	H	H	H	H
W-2	Ph	H	H	H	H	Ph	H
W-3	Ph	Ph	H	H	Ph	Ph	H
W-4	Ph	H	Ph	Ph	H	Ph	H
W-5	Ph	H	Ph	H	H	Ph	H
W-6	Ph	H	H	H	H	Ph	Ph
W-7	Ph	Me	H	H	Me	Ph	H
W-8	Ph	H	Me	Me	H	Ph	H
W-9	Ph	H	H	H	H	Ph	Me
W-10		H	H	H	H		H
W-11		Ph	H	H	Ph		H
W-12		H	Ph	Ph	H		H
W-13		H	Ph	H	H		H
W-14		H	H	H	H		Ph
W-15		Me	H	H	Me		H
W-16		H	Me	Me	H		H
W-17		H	H	H	H		Me
W-18		H	H	H	H		H
W-19		Ph	H	H	Ph		H
W-20		H	Ph	Ph	H		H
W-21		H	Ph	H	H		H
W-22		H	H	H	H		Ph
W-23		Me	H	H	Me		H
W-24		H	Me	Me	H		H
W-25		H	H	H	H		Me

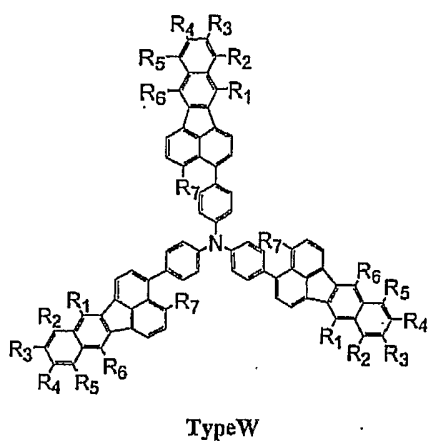

	R ₁	R ₂	R ₃	R ₄	R ₅	R ₆	R ₇
W-26		H	H	H	H		H
W-27		Ph	H	H	Ph		H
W-28		H	Ph	Ph	H		H
W-29		H	Ph	H	H		H
W-30		H	H	H	H		Ph
W-31		Me	H	H	Me		H
W-32		H	Me	Me	H		H
W-33		H	H	H	H		Me
W-34		H	H	H	H		H
W-35		Ph	H	H	Ph		H
W-36		H	Ph	Ph	H		H
W-37		H	Ph	H	H		H
W-38		H	H	H	H		Ph
W-39		Me	H	H	Me		H
W-40		H	Me	Me	H		H
W-41		H	H	H	H		Me
W-42		H	H	H	H		H
W-43		Ph	H	H	Ph		H
4W-4		H	Ph	Ph	H		H
W-45		H	Ph	H	H		H
W-46		H	H	H	H		Ph
W-47		Me	H	H	Me		H
W-48		H	Me	Me	H		H
W-49		H	H	H	H		Me

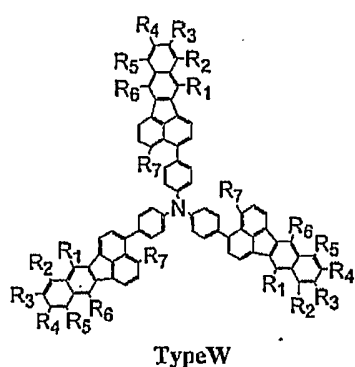

	R ₁	R ₂	R ₃	R ₄	R ₅	R ₆	R ₇
W-50	Ph	H	H	H	H		H
W-51	Ph	H	H	H	H		H
W-52	Ph	H	H	H	H		H
W-53	Ph	H	H	H	H		H
W-54	Ph	H	H	H	H		H
W-55		H	H	H	H		H
W-56		H	H	H	H		H
W-57		H	H	H	H		H
W-58		H	H	H	H		H
W-59		H	H	H	H		H
W-60		H	H	H	H		H
W-61		H	H	H	H		H
W-62		H	H	H	H		H
W-63		H	H	H	H		H
W-64		H	H	H	H		H
W-65	H	Ph	H	H	Ph	H	H
W-66	H		H	H		H	H
W-67	H		H	H		H	H
W-68	H		H	H		H	H
W-69	H		H	H		H	H
W-70	H		H	H		H	H
W-71	H	H			H	H	H
W-72	H	H			H	H	H
W-73	H	H			H	H	H
W-74	H	H			H	H	H
W-75	H	H			H	H	H

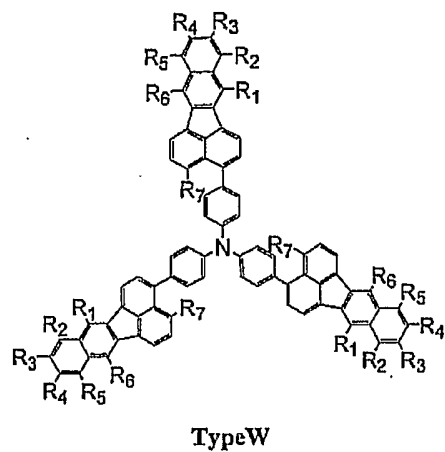

	R ₁	R ₂	R ₃	R ₄	R ₅	R ₆	R ₇
W-76		H	H	H	H		H
W-77		Ph	H	H	Ph		H
W-78		H	Ph	Ph	H		H
W-79		H	Ph	H	H		H
W-80		H	H	H	H		Ph
W-81		Me	H	H	Me		H
W-82		H	Me	Me	H		H
W-83		H	H	H	H		Me
W-84		H	H	H	H		H
W-85		Ph	H	H	Ph		H
W-86		H	Ph	Ph	H		H
W-87		H	Ph	H	H		H
W-88		H	H	H	H		Ph
W-89		Me	H	H	Me		H
W-90		H	Me	Me	H		H
W-91		H	H	H	H		Me
W-92		H	H	H	H		H
W-93		Ph	H	H	Ph		H
W-94		H	Ph	Ph	H		H
W-96		H	Ph	H	H		H
W-96		H	H	H	H		Ph
W-97		Me	H	H	Me		H
W-98		H	Me	Me	H		H
W-99		H	H	H	H		Me

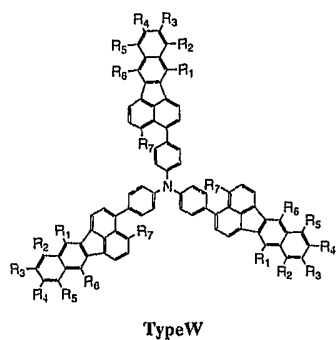

	R ₁	R ₂	R ₃	R ₄	R ₅	R ₆	R ₇
100		H	H	H	H		H
101		Ph	H	H	Ph		H
102		H	Ph	Ph	H		H
103		H	Ph	H	H		H
104		H	H	H	H		Ph
105		Me	H	H	Me		H
106		H	Me	Me	H		H
107		H	H	H	H		Me
108		H	H	H	H		H
109		Ph	H	H	Ph		H
110		H	Ph	Ph	H		H
111		H	Ph	H	H		H
112		H	H	H	H		Ph
113		Me	H	H	Me		H
114		H	Me	Me	H		H
115		H	H	H	H		Me
116		H	H	H	H		H
117		Ph	H	H	Ph		H
118		H	Ph	Ph	H		H
119		H	Ph	H	H		H
120		H	H	H	H		Ph
121		Me	H	H	Me		H
122		H	Me	Me	H		H
123		H	H	H	H		Me

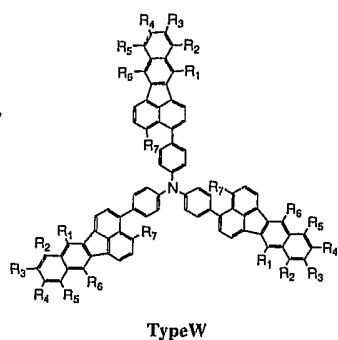

	R ₁	R ₂	R ₃	R ₄	R ₅	R ₆	R ₇
124		H	H	H	H		H
125		Ph	H	H	Ph		H
126		H	Ph	Ph	H		H
127		H	Ph	H	H		H
128		H	H	H	H		Ph
129		Me	H	H	Me		H
130		H	Me	Me	H		H
131		H	H	H	H		Me
132		H	H	H	H		H
133		Ph	H	H	Ph		H
134		H	Ph	Ph	H		H
135		H	Ph	H	H		H
136		H	H	H	H		Ph
137		Me	H	H	Me		H
138		H	Me	Me	H		H
139		H	H	H	H		Me
140		H	H	H	H		H
141		Ph	H	H	Ph		H
142		H	Ph	Ph	H		H
143		H	Ph	H	H		H
144		H	H	H	H		Ph
145		Me	H	H	Me		H
146		H	Me	Me	H		H
147		H	H	H	H		Me

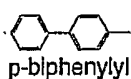
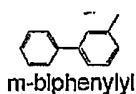
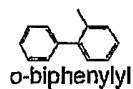
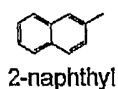
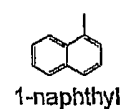
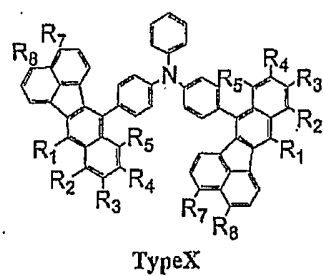

	R ₁	R ₂	R ₃	R ₄	R ₅	R ₇	R ₈
X-1	H	H	H	H	H	H	H
X-2	Ph	H	H	H	H	H	H
X-3	Ph	Ph	H	H	Ph	H	H
X-4	Ph	H	Ph	Ph	H	H	H
X-5	Ph	H	Ph	H	H	H	H
X-6	Ph	H	H	Ph	H	H	H
X-7	Ph	H	H	H	H	Ph	H
X-8	Ph	H	H	H	H	H	Ph
X-9	Ph	H	H	H	H	Ph	Ph
X-10	Ph	H	H	H	H	1-naphthyl	H
X-11	Ph	H	H	H	H	H	1-naphthyl
X-12	Ph	H	H	H	H	1-naphthyl	1-naphthyl
X-13	Ph	H	H	H	H	2-naphthyl	H
X-14	Ph	H	H	H	H	H	2-naphthyl
X-15	Ph	H	H	H	H	2-naphthyl	2-naphthyl
X-16	Ph	H	H	H	H	o-biphenyl	H
X-17	Ph	H	H	H	H	H	o-biphenyl
X-18	Ph	H	H	H	H	o-biphenyl	o-biphenyl
X-19	Ph	H	H	H	H	m-biphenyl	H
X-20	Ph	H	H	H	H	H	m-biphenyl
X-21	Ph	H	H	H	H	m-biphenyl	m-biphenyl
X-22	Ph	H	H	H	H	p-biphenyl	H
X-23	Ph	H	H	H	H	H	p-biphenyl
X-24	Ph	H	H	H	H	p-biphenyl	p-biphenyl
X-25	1-naphthyl	H	H	H	H	H	H
X-26	1-naphthyl	Ph	H	H	Ph	H	H
X-27	1-naphthyl	H	Ph	Ph	H	H	H
X-28	1-naphthyl	H	Ph	H	H	H	H
X-29	1-naphthyl	H	H	Ph	H	H	H
X-30	1-naphthyl	H	H	H	H	Ph	H
X-31	1-naphthyl	H	H	H	H	H	Ph
X-32	1-naphthyl	H	H	H	H	Ph	Ph
X-33	1-naphthyl	H	H	H	H	1-naphthyl	H
X-34	1-naphthyl	H	H	H	H	H	1-naphthyl
X-35	1-naphthyl	H	H	H	H	1-naphthyl	1-naphthyl
X-36	1-naphthyl	H	H	H	H	2-naphthyl	H
X-37	1-naphthyl	H	H	H	H	H	2-naphthyl
X-38	1-naphthyl	H	H	H	H	2-naphthyl	2-naphthyl
X-39	1-naphthyl	H	H	H	H	o-biphenyl	H
X-40	1-naphthyl	H	H	H	H	H	o-biphenyl
X-41	1-naphthyl	H	H	H	H	o-biphenyl	o-biphenyl
X-42	1-naphthyl	H	H	H	H	m-biphenyl	H
X-43	1-naphthyl	H	H	H	H	H	m-biphenyl
X-44	1-naphthyl	H	H	H	H	m-biphenyl	m-biphenyl
X-45	1-naphthyl	H	H	H	H	p-biphenyl	H
X-46	1-naphthyl	H	H	H	H	H	p-biphenyl
X-47	1-naphthyl	H	H	H	H	p-biphenyl	p-biphenyl

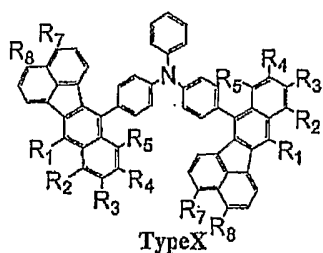

	R ₁	R ₂	R ₃	R ₄	R ₅	R ₇	R ₈
X-48	2-naphthyl	H	H	H	H	H	H
X-49	2-naphthyl	Ph	H	H	Ph	H	H
X-50	2-naphthyl	H	Ph	Ph	H	H	H
X-51	2-naphthyl	H	Ph	H	H	H	H
X-52	2-naphthyl	H	H	Ph	H	H	H
X-53	2-naphthyl	H	H	H	H	Ph	H
X-54	2-naphthyl	H	H	H	H	H	Ph
X-55	2-naphthyl	H	H	H	H	Ph	Ph
X-56	2-naphthyl	H	H	H	H	1-naphthyl	H
X-57	2-naphthyl	H	H	H	H	H	1-naphthyl
X-58	2-naphthyl	H	H	H	H	1-naphthyl	1-naphthyl
X-59	2-naphthyl	H	H	H	H	2-naphthyl	H
X-60	2-naphthyl	H	H	H	H	H	2-naphthyl
X-61	2-naphthyl	H	H	H	H	2-naphthyl	2-naphthyl
X-62	2-naphthyl	H	H	H	H	o-biphenyl	H
X-63	2-naphthyl	H	H	H	H	H	o-biphenyl
X-64	2-naphthyl	H	H	H	H	o-biphenyl	o-biphenyl
X-65	2-naphthyl	H	H	H	H	m-biphenyl	H
X-66	2-naphthyl	H	H	H	H	H	m-biphenyl
X-67	2-naphthyl	H	H	H	H	m-biphenyl	m-biphenyl
X-68	2-naphthyl	H	H	H	H	p-biphenyl	H
X-69	2-naphthyl	H	H	H	H	H	p-biphenyl
X-70	2-naphthyl	H	H	H	H	p-biphenyl	p-biphenyl
X-71	o-biphenyl	H	H	H	H	H	H
X-72	o-biphenyl	Ph	H	H	Ph	H	H
X-73	o-biphenyl	H	Ph	Ph	H	H	H
X-74	o-biphenyl	H	Ph	H	H	H	H
X-75	o-biphenyl	H	H	Ph	H	H	H
X-76	o-biphenyl	H	H	H	H	Ph	H
X-77	o-biphenyl	H	H	H	H	H	Ph
X-78	o-biphenyl	H	H	H	H	Ph	Ph
X-79	o-biphenyl	H	H	H	H	1-naphthyl	H
X-80	o-biphenyl	H	H	H	H	H	1-naphthyl
X-81	o-biphenyl	H	H	H	H	1-naphthyl	1-naphthyl
X-82	o-biphenyl	H	H	H	H	2-naphthyl	H
X-83	o-biphenyl	H	H	H	H	H	2-naphthyl
X-84	o-biphenyl	H	H	H	H	2-naphthyl	2-naphthyl
X-85	o-biphenyl	H	H	H	H	o-biphenyl	H
X-86	o-biphenyl	H	H	H	H	H	o-biphenyl
X-87	o-biphenyl	H	H	H	H	o-biphenyl	o-biphenyl
X-88	o-biphenyl	H	H	H	H	m-biphenyl	H
X-89	o-biphenyl	H	H	H	H	H	m-biphenyl
X-90	o-biphenyl	H	H	H	H	m-biphenyl	m-biphenyl
X-91	o-biphenyl	H	H	H	H	p-biphenyl	H
X-92	o-biphenyl	H	H	H	H	H	p-biphenyl
X-93	o-biphenyl	H	H	H	H	p-biphenyl	p-biphenyl

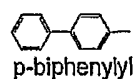
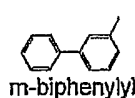
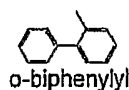
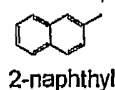
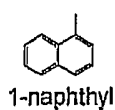

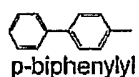
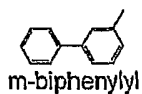
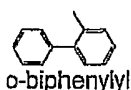
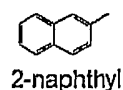
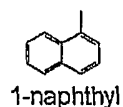
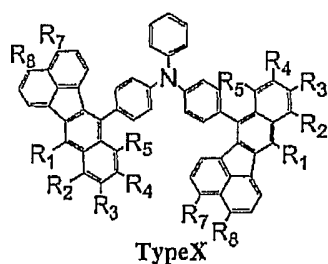



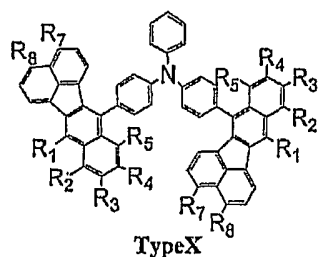



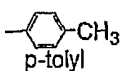
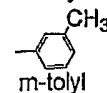
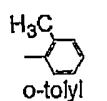
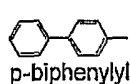
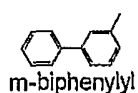
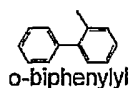
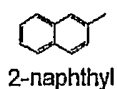
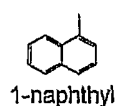

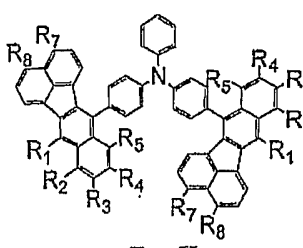

	R ₁	R ₂	R ₃	R ₄	R ₅	R ₇	R ₈
X-94	m-biphenyl	H	H	H	H	H	H
X-95	m-biphenyl	Ph	H	H	Ph	H	H
X-96	m-biphenyl	H	Ph	Ph	H	H	H
X-97	m-biphenyl	H	Ph	H	H	H	H
X-98	m-biphenyl	H	H	Ph	H	H	H
X-99	m-biphenyl	H	H	H	H	Ph	H
X-100	m-biphenyl	H	H	H	H	H	Ph
X-101	m-biphenyl	H	H	H	H	Ph	Ph
X-102	m-biphenyl	H	H	H	H	1-naphthyl	H
X-103	m-biphenyl	H	H	H	H	H	1-naphthyl
X-104	m-biphenyl	H	H	H	H	1-naphthyl	1-naphthyl
X-105	m-biphenyl	H	H	H	H	2-naphthyl	H
X-106	m-biphenyl	H	H	H	H	H	2-naphthyl
X-107	m-biphenyl	H	H	H	H	2-naphthyl	2-naphthyl
X-108	m-biphenyl	H	H	H	H	o-biphenyl	H
X-109	m-biphenyl	H	H	H	H	H	o-biphenyl
X-110	m-biphenyl	H	H	H	H	o-biphenyl	o-biphenyl
X-111	m-biphenyl	H	H	H	H	m-biphenyl	H
X-112	m-biphenyl	H	H	H	H	H	m-biphenyl
X-113	m-biphenyl	H	H	H	H	m-biphenyl	m-biphenyl
X-114	m-biphenyl	H	H	H	H	p-biphenyl	H
X-115	m-biphenyl	H	H	H	H	H	p-biphenyl
X-116	m-biphenyl	H	H	H	H	p-biphenyl	p-biphenyl
X-117	p-biphenyl	H	H	H	H	H	H
X-118	p-biphenyl	Ph	H	H	Ph	H	H
X-119	p-biphenyl	H	Ph	Ph	H	H	H
X-120	p-biphenyl	H	Ph	H	H	H	H
X-121	p-biphenyl	H	H	Ph	H	H	H
X-122	p-biphenyl	H	H	H	H	Ph	H
X-123	p-biphenyl	H	H	H	H	H	Ph
X-124	p-biphenyl	H	H	H	H	Ph	Ph
X-125	p-biphenyl	H	H	H	H	1-naphthyl	H
X-126	p-biphenyl	H	H	H	H	H	1-naphthyl
X-127	p-biphenyl	H	H	H	H	1-naphthyl	1-naphthyl
X-128	p-biphenyl	H	H	H	H	2-naphthyl	H
X-129	p-biphenyl	H	H	H	H	H	2-naphthyl
X-130	p-biphenyl	H	H	H	H	2-naphthyl	2-naphthyl
X-131	p-biphenyl	H	H	H	H	o-biphenyl	H
X-132	p-biphenyl	H	H	H	H	H	o-biphenyl
X-133	p-biphenyl	H	H	H	H	o-biphenyl	o-biphenyl
X-134	p-biphenyl	H	H	H	H	m-biphenyl	H
X-135	p-biphenyl	H	H	H	H	H	m-biphenyl
X-136	p-biphenyl	H	H	H	H	m-biphenyl	m-biphenyl
X-137	p-biphenyl	H	H	H	H	p-biphenyl	H
X-138	p-biphenyl	H	H	H	H	H	p-biphenyl
X-139	p-biphenyl	H	H	H	H	p-biphenyl	p-biphenyl



	R ₁	R ₂	R ₃	R ₄	R ₅	R ₇	R ₈
X-140	o-tolyl	H	H	H	H	H	H
X-141	o-tolyl	Ph	H	H	Ph	H	H
X-142	o-tolyl	H	Ph	Ph	H	H	H
X-143	o-tolyl	H	H	H	H	Ph	H
X-144	o-tolyl	H	H	H	H	H	Ph
X-145	o-tolyl	H	H	H	H	1-naphthyl	H
X-146	o-tolyl	H	H	H	H	H	1-naphthyl
X-147	o-tolyl	H	H	H	H	2-naphthyl	H
X-148	o-tolyl	H	H	H	H	H	2-naphthyl
X-149	o-tolyl	H	H	H	H	o-biphenyl	H
X-150	o-tolyl	H	H	H	H	H	o-biphenyl
X-151	o-tolyl	H	H	H	H	m-biphenyl	H
X-152	o-tolyl	H	H	H	H	H	m-biphenyl
X-153	o-tolyl	H	H	H	H	p-biphenyl	H
X-154	o-tolyl	H	H	H	H	H	p-biphenyl
X-155	o-tolyl	H	H	H	H	o-tolyl	H
X-156	o-tolyl	H	H	H	H	H	o-tolyl
X-157	m-tolyl	H	H	H	H	H	H
X-158	m-tolyl	Ph	H	H	Ph	H	H
X-159	m-tolyl	H	Ph	Ph	H	H	H
X-160	m-tolyl	H	H	H	H	Ph	H
X-161	m-tolyl	H	H	H	H	H	Ph
X-162	m-tolyl	H	H	H	H	1-naphthyl	H
X-163	m-tolyl	H	H	H	H	H	1-naphthyl
X-164	m-tolyl	H	H	H	H	2-naphthyl	H
X-165	m-tolyl	H	H	H	H	H	2-naphthyl
X-166	m-tolyl	H	H	H	H	o-biphenyl	H
X-167	m-tolyl	H	H	H	H	H	o-biphenyl
X-168	m-tolyl	H	H	H	H	m-biphenyl	H
X-169	m-tolyl	H	H	H	H	H	m-biphenyl
X-170	m-tolyl	H	H	H	H	p-biphenyl	H
X-171	m-tolyl	H	H	H	H	H	p-biphenyl
X-172	m-tolyl	H	H	H	H	m-tolyl	H
X-173	m-tolyl	H	H	H	H	H	m-tolyl
X-174	p-tolyl	H	H	H	H	H	H
X-175	p-tolyl	Ph	H	H	Ph	H	H
X-176	p-tolyl	H	Ph	Ph	H	H	H
X-177	p-tolyl	H	H	H	H	Ph	H
X-178	p-tolyl	H	H	H	H	H	Ph
X-179	p-tolyl	H	H	H	H	1-naphthyl	H
X-180	p-tolyl	H	H	H	H	H	1-naphthyl
X-181	p-tolyl	H	H	H	H	2-naphthyl	H
X-182	p-tolyl	H	H	H	H	H	2-naphthyl
X-183	p-tolyl	H	H	H	H	o-biphenyl	H
X-184	p-tolyl	H	H	H	H	H	o-biphenyl
X-185	p-tolyl	H	H	H	H	m-biphenyl	H
X-186	p-tolyl	H	H	H	H	H	m-biphenyl
X-187	p-tolyl	H	H	H	H	p-biphenyl	H
X-188	p-tolyl	H	H	H	H	H	p-biphenyl
X-189	p-tolyl	H	H	H	H	p-tolyl	H
X-190	p-tolyl	H	H	H	H	H	p-tolyl



	R ₁	R ₂	R ₃	R ₄	R ₅	R ₇	R ₈
							
	X-191	Ph	H	-CH3	-CH3	H	H
	X-192	1-naphthyl	H	-CH3	-CH3	H	H
	X-193	2-naphthyl	H	-CH3	-CH3	H	H
	X-194	o-biphenylyl	H	-CH3	-CH3	H	H
	X-195	m-biphenylyl	H	-CH3	-CH3	H	H
	X-196	p-biphenylyl	H	-CH3	-CH3	H	H
	X-197	o-tolyl	H	-CH3	-CH3	H	H
	X-198	m-tolyl	H	-CH3	-CH3	H	H
	X-199	p-tolyl	H	-CH3	-CH3	H	H
	X-200	Ph	H	H	H	-CH3	H
	X-201	1-naphthyl	H	H	H	-CH3	H
	X-202	2-naphthyl	H	H	H	-CH3	H
	X-203	o-biphenylyl	H	H	H	-CH3	H
	X-204	m-biphenylyl	H	H	H	-CH3	H
	X-205	p-biphenylyl	H	H	H	-CH3	H
	X-206	o-tolyl	H	H	H	-CH3	H
	X-207	m-tolyl	H	H	H	-CH3	H
	X-208	p-tolyl	H	H	H	-CH3	H
	X-209	Ph	H	H	H	H	-CH3
	X-210	1-naphthyl	H	H	H	H	-CH3
	X-211	2-naphthyl	H	H	H	H	-CH3
	X-212	o-biphenylyl	H	H	H	H	-CH3
	X-213	m-biphenylyl	H	H	H	H	-CH3
	X-214	p-biphenylyl	H	H	H	H	-CH3
		X-215	o-tolyl	H	H	H	-CH3
	X-216	m-tolyl	H	H	H	H	-CH3
		X-217	p-tolyl	H	H	H	-CH3
	X-218	Ph	H	H	H	-CH3	-CH3
		X-219	1-naphthyl	H	H	H	-CH3
	X-220	2-naphthyl	H	H	H	-CH3	-CH3
	X-221	o-biphenylyl	H	H	H	-CH3	-CH3
		X-222	m-biphenylyl	H	H	H	-CH3
	X-223	p-biphenylyl	H	H	H	-CH3	-CH3
	X-224	o-tolyl	H	H	H	-CH3	-CH3
		X-225	m-tolyl	H	H	H	-CH3
	X-226	p-tolyl	H	H	H	-CH3	-CH3
	X-227	Ph	H	H	H	H	DPA
	X-228	1-naphthyl	H	H	H	H	DPA
		X-229	2-naphthyl	H	H	H	DPA
	X-230	o-biphenylyl	H	H	H	H	DPA
	X-231	m-biphenylyl	H	H	H	H	DPA
		X-232	p-biphenylyl	H	H	H	DPA
	X-233	Ph	H	H	H	DPA	H
		X-234	1-naphthyl	H	H	H	DPA
	X-235	2-naphthyl	H	H	H	DPA	H
	X-236	o-biphenylyl	H	H	H	DPA	H
	X-237	m-biphenylyl	H	H	H	DPA	H
	X-238	p-biphenylyl	H	H	H	DPA	H
	X-239	Ph	H	H	H	H	TPA
		X-240	1-naphthyl	H	H	H	TPA
	X-241	2-naphthyl	H	H	H	H	TPA
	X-242	o-biphenylyl	H	H	H	H	TPA
	X-243	m-biphenylyl	H	H	H	H	TPA
	X-244	p-biphenylyl	H	H	H	H	TPA
		X-245	Ph	H	H	H	TPA
	X-246	1-naphthyl	H	H	H	TPA	H
	X-247	2-naphthyl	H	H	H	TPA	H
	X-248	o-biphenylyl	H	H	H	TPA	H
	X-249	m-biphenylyl	H	H	H	TPA	H
	X-250	p-biphenylyl	H	H	H	TPA	H

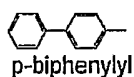
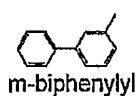
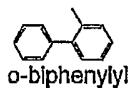
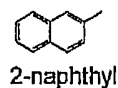
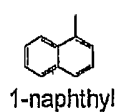
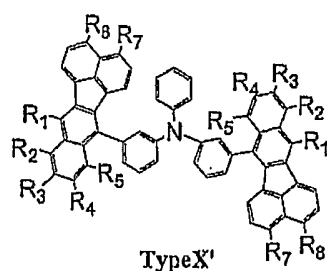

	R ₁	R ₂	R ₃	R ₄	R ₅	R ₇	R ₈
X'-1	H	H	H	H	H	H	H
X'-2	Ph	H	H	H	H	H	H
X'-3	Ph	Ph	H	H	Ph	H	H
X'-4	Ph	H	Ph	Ph	H	H	H
X'-5	Ph	H	Ph	H	H	H	H
X'-6	Ph	H	H	Ph	H	H	H
X'-7	Ph	H	H	H	H	Ph	H
X'-8	Ph	H	H	H	H	H	Ph
X'-9	Ph	H	H	H	H	Ph	Ph
X'-10	Ph	H	H	H	H	1-naphthyl	H
X'-11	Ph	H	H	H	H	H	1-naphthyl
X'-12	Ph	H	H	H	H	1-naphthyl	1-naphthyl
X'-13	Ph	H	H	H	H	2-naphthyl	H
X'-14	Ph	H	H	H	H	H	2-naphthyl
X'-15	Ph	H	H	H	H	2-naphthyl	2-naphthyl
X'-16	Ph	H	H	H	H	o-biphenylyl	H
X'-17	Ph	H	H	H	H	H	o-biphenylyl
X'-18	Ph	H	H	H	H	o-biphenylyl	o-biphenylyl
X'-19	Ph	H	H	H	H	m-biphenylyl	H
X'-20	Ph	H	H	H	H	H	m-biphenylyl
X'-21	Ph	H	H	H	H	m-biphenylyl	m-biphenylyl
X'-22	Ph	H	H	H	H	p-biphenylyl	H
X'-23	Ph	H	H	H	H	H	p-biphenylyl
X'-24	Ph	H	H	H	H	p-biphenylyl	p-biphenylyl
X'-25	1-naphthyl	H	H	H	H	H	H
X'-26	1-naphthyl	Ph	H	H	Ph	H	H
X'-27	1-naphthyl	H	Ph	Ph	H	H	H
X'-28	1-naphthyl	H	Ph	H	H	H	H
X'-29	1-naphthyl	H	H	Ph	H	H	H
X'-30	1-naphthyl	H	H	H	H	Ph	H
X'-31	1-naphthyl	H	H	H	H	H	Ph
X'-32	1-naphthyl	H	H	H	H	Ph	Ph
X'-33	1-naphthyl	H	H	H	H	1-naphthyl	H
X'-34	1-naphthyl	H	H	H	H	H	1-naphthyl
X'-35	1-naphthyl	H	H	H	H	1-naphthyl	1-naphthyl
X'-36	1-naphthyl	H	H	H	H	2-naphthyl	H
X'-37	1-naphthyl	H	H	H	H	H	2-naphthyl
X'-38	1-naphthyl	H	H	H	H	2-naphthyl	2-naphthyl
X'-39	1-naphthyl	H	H	H	H	o-biphenylyl	H
X'-40	1-naphthyl	H	H	H	H	H	o-biphenylyl
X'-41	1-naphthyl	H	H	H	H	o-biphenylyl	o-biphenylyl
X'-42	1-naphthyl	H	H	H	H	m-biphenylyl	H
X'-43	1-naphthyl	H	H	H	H	H	m-biphenylyl
X'-44	1-naphthyl	H	H	H	H	m-biphenylyl	m-biphenylyl
X'-45	1-naphthyl	H	H	H	H	p-biphenylyl	H
X'-46	1-naphthyl	H	H	H	H	H	p-biphenylyl
X'-47	1-naphthyl	H	H	H	H	p-biphenylyl	p-biphenylyl

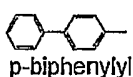
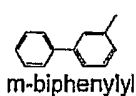
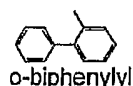
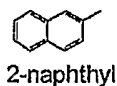
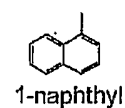
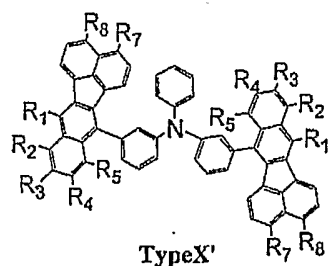

	R ₁	R ₂	R ₃	R ₄	R ₅	R ₇	R ₈
		+					
X'-48	2-naphthyl	H	H	H	H	H	H
X'-49	2-naphthyl	Ph	H	H	Ph	H	H
X'-50	2-naphthyl	H	Ph	Ph	H	H	H
X'-51	2-naphthyl	H	Ph	H	H	H	H
X'-52	2-naphthyl	H	H	Ph	H	H	H
X'-53	2-naphthyl	H	H	H	H	Ph	H
X'-54	2-naphthyl	H	H	H	H	H	Ph
X'-55	2-naphthyl	H	H	H	H	Ph	Ph
X'-56	2-naphthyl	H	H	H	H	1-naphthyl	H
X'-57	2-naphthyl	H	H	H	H	H	1-naphthyl
X'-58	2-naphthyl	H	H	H	H	1-naphthyl	1-naphthyl
X'-59	2-naphthyl	H	H	H	H	2-naphthyl	H
X'-60	2-naphthyl	H	H	H	H	H	2-naphthyl
X'-61	2-naphthyl	H	H	H	H	2-naphthyl	2-naphthyl
X'-62	2-naphthyl	H	H	H	H	o-biphenyl	H
X'-63	2-naphthyl	H	H	H	H	H	o-biphenyl
X'-64	2-naphthyl	H	H	H	H	o-biphenyl	o-biphenyl
X'-65	2-naphthyl	H	H	H	H	m-biphenyl	H
X'-66	2-naphthyl	H	H	H	H	H	m-biphenyl
X'-67	2-naphthyl	H	H	H	H	m-biphenyl	m-biphenyl
X'-68	2-naphthyl	H	H	H	H	p-biphenyl	H
X'-69	2-naphthyl	H	H	H	H	H	p-biphenyl
X'-70	2-naphthyl	H	H	H	H	p-biphenyl	p-biphenyl
X'-71	o-biphenyl	H	H	H	H	H	H
X'-72	o-biphenyl	Ph	H	H	Ph	H	H
X'-73	o-biphenyl	H	Ph	Ph	H	H	H
X'-74	o-biphenyl	H	Ph	H	H	H	H
X'-75	o-biphenyl	H	H	Ph	H	H	H
X'-76	o-biphenyl	H	H	H	H	Ph	H
X'-77	o-biphenyl	H	H	H	H	H	Ph
X'-78	o-biphenyl	H	H	H	H	Ph	Ph
X'-79	o-biphenyl	H	H	H	H	1-naphthyl	H
X'-80	o-biphenyl	H	H	H	H	H	1-naphthyl
X'-81	o-biphenyl	H	H	H	H	1-naphthyl	1-naphthyl
X'-82	o-biphenyl	H	H	H	H	2-naphthyl	H
X'-83	o-biphenyl	H	H	H	H	H	2-naphthyl
X'-84	o-biphenyl	H	H	H	H	2-naphthyl	2-naphthyl
X'-85	o-biphenyl	H	H	H	H	o-biphenyl	H
X'-86	o-biphenyl	H	H	H	H	H	o-biphenyl
X'-87	o-biphenyl	H	H	H	H	o-biphenyl	o-biphenyl
X'-88	o-biphenyl	H	H	H	H	m-biphenyl	H
X'-89	o-biphenyl	H	H	H	H	H	m-biphenyl
X'-90	o-biphenyl	H	H	H	H	m-biphenyl	m-biphenyl
X'-91	o-biphenyl	H	H	H	H	p-biphenyl	H
X'-92	o-biphenyl	H	H	H	H	H	p-biphenyl
X'-93	o-biphenyl	H	H	H	H	p-biphenyl	p-biphenyl

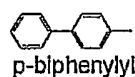
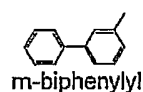
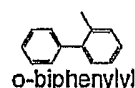
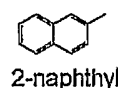
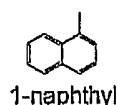
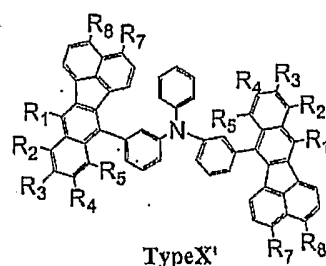

	R ₁	R ₂	R ₃	R ₄	R ₅	R ₇	R ₈
X'-94	m-biphenylyl	H	H	H	H	H	H
X'-95	m-biphenylyl	Ph	H	H	Ph	H	H
X'-96	m-biphenylyl	H	Ph	Ph	H	H	H
X'-97	m-biphenylyl	H	Ph	H	H	H	H
X'-98	m-biphenylyl	H	H	Ph	H	H	H
X'-99	m-biphenylyl	H	H	H	H	Ph	H
X'-100	m-biphenylyl	H	H	H	H	H	Ph
X'-101	m-biphenylyl	H	H	H	H	Ph	Ph
X'-102	m-biphenylyl	H	H	H	H	1-naphthyl	H
X'-103	m-biphenylyl	H	H	H	H	H	1-naphthyl
X'-104	m-biphenylyl	H	H	H	H	1-naphthyl	1-naphthyl
X'-105	m-biphenylyl	H	H	H	H	2-naphthyl	H
X'-106	m-biphenylyl	H	H	H	H	H	2-naphthyl
X'-107	m-biphenylyl	H	H	H	H	2-naphthyl	2-naphthyl
X'-108	m-biphenylyl	H	H	H	H	o-biphenylyl	H
X'-109	m-biphenylyl	H	H	H	H	H	o-biphenylyl
X'-110	m-biphenylyl	H	H	H	H	o-biphenylyl	o-biphenylyl
X'-111	m-biphenylyl	H	H	H	H	m-biphenylyl	H
X'-112	m-biphenylyl	H	H	H	H	H	m-biphenylyl
X'-113	m-biphenylyl	H	H	H	H	m-biphenylyl	m-biphenylyl
X'-114	m-biphenylyl	H	H	H	H	p-biphenylyl	H
X'-115	m-biphenylyl	H	H	H	H	H	p-biphenylyl
X'-116	m-biphenylyl	H	H	H	H	p-biphenylyl	p-biphenylyl
X'-117	p-biphenylyl	H	H	H	H	H	H
X'-118	p-biphenylyl	Ph	H	H	Ph	H	H
X'-119	p-biphenylyl	H	Ph	Ph	H	H	H
X'-120	p-biphenylyl	H	Ph	H	H	H	H
X'-121	p-biphenylyl	H	H	Ph	H	H	H
X'-122	p-biphenylyl	H	H	H	H	Ph	H
X'-123	p-biphenylyl	H	H	H	H	H	Ph
X'-124	p-biphenylyl	H	H	H	H	Ph	Ph
X'-125	p-biphenylyl	H	H	H	H	1-naphthyl	H
X'-126	p-biphenylyl	H	H	H	H	H	1-naphthyl
X'-127	p-biphenylyl	H	H	H	H	1-naphthyl	1-naphthyl
X'-128	p-biphenylyl	H	H	H	H	2-naphthyl	H
X'-129	p-biphenylyl	H	H	H	H	H	2-naphthyl
X'-130	p-biphenylyl	H	H	H	H	2-naphthyl	2-naphthyl
X'-131	p-biphenylyl	H	H	H	H	o-biphenylyl	H
X'-132	p-biphenylyl	H	H	H	H	H	o-biphenylyl
X'-133	p-biphenylyl	H	H	H	H	o-biphenylyl	o-biphenylyl
X'-134	p-biphenylyl	H	H	H	H	m-biphenylyl	H
X'-135	p-biphenylyl	H	H	H	H	H	m-biphenylyl
X'-136	p-biphenylyl	H	H	H	H	m-biphenylyl	m-biphenylyl
X'-137	p-biphenylyl	H	H	H	H	p-biphenylyl	H
X'-138	p-biphenylyl	H	H	H	H	H	p-biphenylyl
X'-139	p-biphenylyl	H	H	H	H	p-biphenylyl	p-biphenylyl

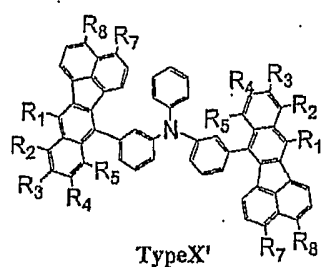

	R ₁	R ₂	R ₃	R ₄	R ₅	R ₇	R ₈
X'-140	o-tolyl	H	H	H	H	H	H
X'-141	o-tolyl	Ph	H	H	Ph	H	H
X'-142	o-tolyl	H	Ph	Ph	H	H	H
X'-143	o-tolyl	H	H	H	H	Ph	H
X'-144	o-tolyl	H	H	H	H	H	Ph
X'-145	o-tolyl	H	H	H	H	1-naphthyl	H
X'-146	o-tolyl	H	H	H	H	H	1-naphthyl
X'-147	o-tolyl	H	H	H	H	2-naphthyl	H
X'-148	o-tolyl	H	H	H	H	H	2-naphthyl
X'-149	o-tolyl	H	H	H	H	o-biphenyl	H
X'-150	o-tolyl	H	H	H	H	H	o-biphenyl
X'-151	o-tolyl	H	H	H	H	m-biphenyl	H
X'-152	o-tolyl	H	H	H	H	H	m-biphenyl
X'-153	o-tolyl	H	H	H	H	p-biphenyl	H
X'-154	o-tolyl	H	H	H	H	H	p-biphenyl
X'-155	o-tolyl	H	H	H	H	o-tolyl	H
X'-156	o-tolyl	H	H	H	H	H	o-tolyl
X'-157	m-tolyl	H	H	H	H	H	H
X'-158	m-tolyl	Ph	H	H	Ph	H	H
X'-159	m-tolyl	H	Ph	Ph	H	H	H
X'-160	m-tolyl	H	H	H	H	Ph	H
X'-161	m-tolyl	H	H	H	H	H	Ph
X'-162	m-tolyl	H	H	H	H	1-naphthyl	H
X'-163	m-tolyl	H	H	H	H	H	1-naphthyl
X'-164	m-tolyl	H	H	H	H	2-naphthyl	H
X'-165	m-tolyl	H	H	H	H	H	2-naphthyl
X'-166	m-tolyl	H	H	H	H	o-biphenyl	H
X'-167	m-tolyl	H	H	H	H	H	o-biphenyl
X'-168	m-tolyl	H	H	H	H	m-biphenyl	H
X'-169	m-tolyl	H	H	H	H	H	m-biphenyl
X'-170	m-tolyl	H	H	H	H	p-biphenyl	H
X'-171	m-tolyl	H	H	H	H	H	p-biphenyl
X'-172	m-tolyl	H	H	H	H	m-tolyl	H
X'-173	m-tolyl	H	H	H	H	H	m-tolyl
X'-174	p-tolyl	H	H	H	H	H	H
X'-175	p-tolyl	Ph	H	H	Ph	H	H
X'-176	p-tolyl	H	Ph	Ph	H	H	H
X'-177	p-tolyl	H	H	H	H	Ph	H
X'-178	p-tolyl	H	H	H	H	H	Ph
X'-179	p-tolyl	H	H	H	H	1-naphthyl	H
X'-180	p-tolyl	H	H	H	H	H	1-naphthyl
X'-181	p-tolyl	H	H	H	H	2-naphthyl	H
X'-182	p-tolyl	H	H	H	H	H	2-naphthyl
X'-183	p-tolyl	H	H	H	H	o-biphenyl	H
X'-184	p-tolyl	H	H	H	H	H	o-biphenyl
X'-185	p-tolyl	H	H	H	H	m-biphenyl	H
X'-186	p-tolyl	H	H	H	H	H	m-biphenyl
X'-187	p-tolyl	H	H	H	H	p-biphenyl	H
X'-188	p-tolyl	H	H	H	H	H	p-biphenyl
X'-189	p-tolyl	H	H	H	H	p-tolyl	H
X'-190	p-tolyl	H	H	H	H	H	p-tolyl

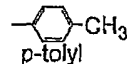
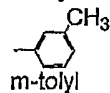
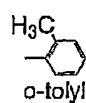
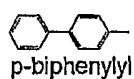
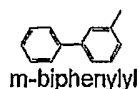
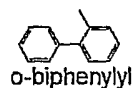
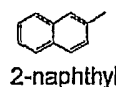
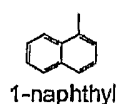

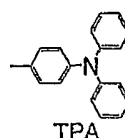
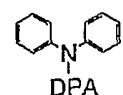
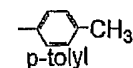
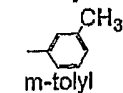
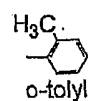
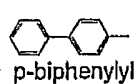
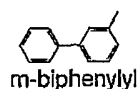
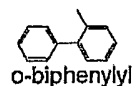
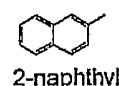
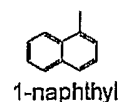
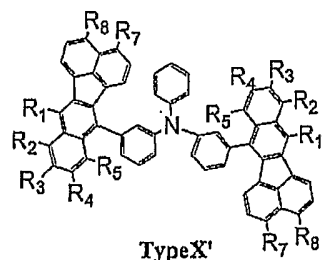

	R ₁	R ₂	R ₃	R ₄	R ₅	R ₇	R ₈
X'-191	Ph	H	-CH ₃	-CH ₃	H	H	H
X'-192	1-naphthyl	H	-CH ₃	-CH ₃	H	H	H
X'-193	2-naphthyl	H	-CH ₃	-CH ₃	H	H	H
X'-194	o-biphenyl	H	-CH ₃	-CH ₃	H	H	H
X'-195	m-biphenyl	H	-CH ₃	-CH ₃	H	H	H
X'-196	p-biphenyl	H	-CH ₃	-CH ₃	H	H	H
X'-197	o-tolyl	H	-CH ₃	-CH ₃	H	H	H
X'-198	m-tolyl	H	-CH ₃	-CH ₃	H	H	H
X'-199	p-tolyl	H	-CH ₃	-CH ₃	H	H	H
X'-200	Ph	H	H	H	H	-CH ₃	H
X'-201	1-naphthyl	H	H	H	H	-CH ₃	H
X'-202	2-naphthyl	H	H	H	H	-CH ₃	H
X'-203	o-biphenyl	H	H	H	H	-CH ₃	H
X'-204	m-biphenyl	H	H	H	H	-CH ₃	H
X'-205	p-biphenyl	H	H	H	H	-CH ₃	H
X'-206	o-tolyl	H	H	H	H	-CH ₃	H
X'-207	m-tolyl	H	H	H	H	-CH ₃	H
X'-208	p-tolyl	H	H	H	H	-CH ₃	H
X'-209	Ph	H	H	H	H	H	-CH ₃
X'-210	1-naphthyl	H	H	H	H	H	-CH ₃
X'-211	2-naphthyl	H	H	H	H	H	-CH ₃
X'-212	o-biphenyl	H	H	H	H	H	-CH ₃
X'-213	m-biphenyl	H	H	H	H	H	-CH ₃
X'-214	p-biphenyl	H	H	H	H	H	-CH ₃
X'-215	o-tolyl	H	H	H	H	H	-CH ₃
X'-216	m-tolyl	H	H	H	H	H	-CH ₃
X'-217	p-tolyl	H	H	H	H	H	-CH ₃
X'-218	Ph	H	H	H	H	-CH ₃	-CH ₃
X'-219	1-naphthyl	H	H	H	H	-CH ₃	-CH ₃
X'-220	2-naphthyl	H	H	H	H	-CH ₃	-CH ₃
X'-221	o-biphenyl	H	H	H	H	-CH ₃	-CH ₃
X'-222	m-biphenyl	H	H	H	H	-CH ₃	-CH ₃
X'-223	p-biphenyl	H	H	H	H	-CH ₃	-CH ₃
X'-224	o-tolyl	H	H	H	H	-CH ₃	-CH ₃
X'-225	m-tolyl	H	H	H	H	-CH ₃	-CH ₃
X'-226	p-tolyl	H	H	H	H	-CH ₃	-CH ₃
X'-227	Ph	H	H	H	H	H	DPA
X'-228	1-naphthyl	H	H	H	H	H	DPA
X'-229	2-naphthyl	H	H	H	H	H	DPA
X'-230	o-biphenyl	H	H	H	H	H	DPA
X'-231	m-biphenyl	H	H	H	H	H	DPA
X'-232	p-biphenyl	H	H	H	H	H	DPA
X'-233	Ph	H	H	H	H	DPA	H
X'-234	1-naphthyl	H	H	H	H	DPA	H
X'-235	2-naphthyl	H	H	H	H	DPA	H
X'-236	o-biphenyl	H	H	H	H	DPA	H
X'-237	m-biphenyl	H	H	H	H	DPA	H
X'-238	p-biphenyl	H	H	H	H	DPA	H
X'-239	Ph	H	H	H	H	H	TPA
X'-240	1-naphthyl	H	H	H	H	H	TPA
X'-241	2-naphthyl	H	H	H	H	H	TPA
X'-242	o-biphenyl	H	H	H	H	H	TPA
X'-243	m-biphenyl	H	H	H	H	H	TPA
X'-244	p-biphenyl	H	H	H	H	H	TPA
X'-245	Ph	H	H	H	H	TPA	H
X'-246	1-naphthyl	H	H	H	H	TPA	H
X'-247	2-naphthyl	H	H	H	H	TPA	H
X'-248	o-biphenyl	H	H	H	H	TPA	H
X'-249	m-biphenyl	H	H	H	H	TPA	H
X'-250	p-biphenyl	H	H	H	H	TPA	H

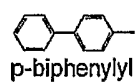
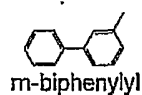
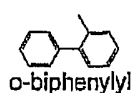
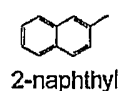
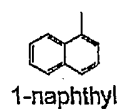
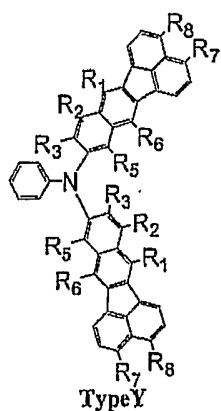

	R ₁	R ₂	R ₃	R ₅	R ₆	R ₇	R ₈
Y-1	H	H	H	H	H	H	H
Y-2	Ph	H	H	H	Ph	H	H
Y-3	Ph	Ph	H	H	Ph	H	H
Y-4	Ph	H	H	Ph	Ph	H	H
Y-5	Ph	Ph	H	Ph	Ph	H	H
Y-6	Ph	H	Ph	H	Ph	H	H
Y-7	Ph	H	H	H	Ph	Ph	H
Y-8	Ph	H	H	H	Ph	H	Ph
Y-9	Ph	H	H	H	Ph	Ph	Ph
Y-10	Ph	H	H	H	Ph	1-naphthyl	H
Y-11	Ph	H	H	H	Ph	H	1-naphthyl
Y-12	Ph	H	H	H	Ph	1-naphthyl	1-naphthyl
Y-13	Ph	H	H	H	Ph	2-naphthyl	H
Y-14	Ph	H	H	H	Ph	H	2-naphthyl
Y-15	Ph	H	H	H	Ph	2-naphthyl	2-naphthyl
Y-16	Ph	H	H	H	Ph	o-biphenylyl	H
Y-17	Ph	H	H	H	Ph	H	o-biphenylyl
Y-18	Ph	H	H	H	Ph	o-biphenylyl	o-biphenylyl
Y-19	Ph	H	H	H	Ph	m-biphenylyl	H
Y-20	Ph	H	H	H	Ph	H	m-biphenylyl
Y-21	Ph	H	H	H	Ph	m-biphenylyl	m-biphenylyl
Y-22	Ph	H	H	H	Ph	p-biphenylyl	H
Y-23	Ph	H	H	H	Ph	H	p-biphenylyl
Y-24	Ph	H	H	H	Ph	p-biphenylyl	p-biphenylyl
Y-25	1-naphthyl	H	H	H	1-naphthyl	H	H
Y-26	1-naphthyl	Ph	H	H	1-naphthyl	H	H
Y-27	1-naphthyl	H	H	Ph	1-naphthyl	H	H
Y-28	1-naphthyl	Ph	H	Ph	1-naphthyl	H	H
Y-29	1-naphthyl	H	Ph	H	1-naphthyl	H	H
Y-30	1-naphthyl	H	H	H	1-naphthyl	Ph	H
Y-31	1-naphthyl	H	H	H	1-naphthyl	H	Ph
Y-32	1-naphthyl	H	H	H	1-naphthyl	Ph	Ph
Y-33	1-naphthyl	H	H	H	1-naphthyl	1-naphthyl	H
Y-34	1-naphthyl	H	H	H	1-naphthyl	H	1-naphthyl
Y-35	1-naphthyl	H	H	H	1-naphthyl	1-naphthyl	1-naphthyl
Y-36	1-naphthyl	H	H	H	1-naphthyl	2-naphthyl	H
Y-37	1-naphthyl	H	H	H	1-naphthyl	H	2-naphthyl
Y-38	1-naphthyl	H	H	H	1-naphthyl	2-naphthyl	2-naphthyl
Y-39	1-naphthyl	H	H	H	1-naphthyl	o-biphenylyl	H
Y-40	1-naphthyl	H	H	H	1-naphthyl	H	o-biphenylyl
Y-41	1-naphthyl	H	H	H	1-naphthyl	o-biphenylyl	o-biphenylyl
Y-42	1-naphthyl	H	H	H	1-naphthyl	m-biphenylyl	H
Y-43	1-naphthyl	H	H	H	1-naphthyl	H	m-biphenylyl
Y-44	1-naphthyl	H	H	H	1-naphthyl	m-biphenylyl	m-biphenylyl
Y-45	1-naphthyl	H	H	H	1-naphthyl	p-biphenylyl	H
Y-46	1-naphthyl	H	H	H	1-naphthyl	H	p-biphenylyl
Y-47	1-naphthyl	H	H	H	1-naphthyl	p-biphenylyl	p-biphenylyl

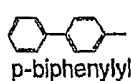
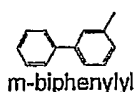
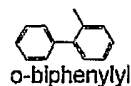
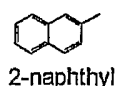
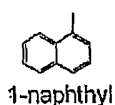
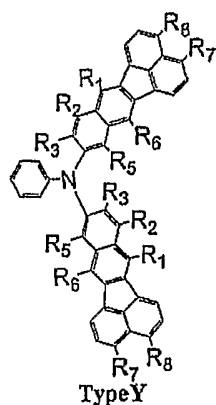

	R ₁	R ₂	R ₃	R ₅	R ₆	R ₇	R ₈
Y-48	2-naphthyl	H	H	H	2-naphthyl	H	H
Y-49	2-naphthyl	Ph	H	H	2-naphthyl	H	H
Y-50	2-naphthyl	H	H	Ph	2-naphthyl	H	H
Y-51	2-naphthyl	Ph	H	Ph	2-naphthyl	H	H
Y-52	2-naphthyl	H	Ph	H	2-naphthyl	H	H
Y-53	2-naphthyl	H	H	H	2-naphthyl	Ph	H
Y-54	2-naphthyl	H	H	H	2-naphthyl	H	Ph
Y-55	2-naphthyl	H	H	H	2-naphthyl	Ph	Ph
Y-56	2-naphthyl	H	H	H	2-naphthyl	1-naphthyl	H
Y-57	2-naphthyl	H	H	H	2-naphthyl	H	1-naphthyl
Y-58	2-naphthyl	H	H	H	2-naphthyl	1-naphthyl	1-naphthyl
Y-59	2-naphthyl	H	H	H	2-naphthyl	2-naphthyl	H
Y-60	2-naphthyl	H	H	H	2-naphthyl	H	2-naphthyl
Y-61	2-naphthyl	H	H	H	2-naphthyl	2-naphthyl	2-naphthyl
Y-62	2-naphthyl	H	H	H	2-naphthyl	o-biphenyl	H
Y-63	2-naphthyl	H	H	H	2-naphthyl	H	o-biphenyl
Y-64	2-naphthyl	H	H	H	2-naphthyl	o-biphenyl	o-biphenyl
Y-65	2-naphthyl	H	H	H	2-naphthyl	m-biphenyl	H
Y-66	2-naphthyl	H	H	H	2-naphthyl	H	m-biphenyl
Y-67	2-naphthyl	H	H	H	2-naphthyl	m-biphenyl	m-biphenyl
Y-68	2-naphthyl	H	H	H	2-naphthyl	p-biphenyl	H
Y-69	2-naphthyl	H	H	H	2-naphthyl	H	p-biphenyl
Y-70	2-naphthyl	H	H	H	2-naphthyl	p-biphenyl	p-biphenyl
Y-71	o-biphenyl	H	H	H	o-biphenyl	H	H
Y-72	o-biphenyl	Ph	H	H	o-biphenyl	H	H
Y-73	o-biphenyl	H	H	Ph	o-biphenyl	H	H
Y-74	o-biphenyl	Ph	H	Ph	o-biphenyl	H	H
Y-75	o-biphenyl	H	Ph	H	o-biphenyl	H	H
Y-76	o-biphenyl	H	H	H	o-biphenyl	Ph	H
Y-77	o-biphenyl	H	H	H	o-biphenyl	H	Ph
Y-78	o-biphenyl	H	H	H	o-biphenyl	Ph	Ph
Y-79	o-biphenyl	H	H	H	o-biphenyl	1-naphthyl	H
Y-80	o-biphenyl	H	H	H	o-biphenyl	H	1-naphthyl
Y-81	o-biphenyl	H	H	H	o-biphenyl	1-naphthyl	1-naphthyl
Y-82	o-biphenyl	H	H	H	o-biphenyl	2-naphthyl	H
Y-83	o-biphenyl	H	H	H	o-biphenyl	H	2-naphthyl
Y-84	o-biphenyl	H	H	H	o-biphenyl	2-naphthyl	2-naphthyl
Y-85	o-biphenyl	H	H	H	o-biphenyl	o-biphenyl	H
Y-86	o-biphenyl	H	H	H	o-biphenyl	H	o-biphenyl
Y-87	o-biphenyl	H	H	H	o-biphenyl	o-biphenyl	o-biphenyl
Y-88	o-biphenyl	H	H	H	o-biphenyl	m-biphenyl	H
Y-89	o-biphenyl	H	H	H	o-biphenyl	H	m-biphenyl
Y-90	o-biphenyl	H	H	H	o-biphenyl	m-biphenyl	m-biphenyl
Y-91	o-biphenyl	H	H	H	o-biphenyl	p-biphenyl	H
Y-92	o-biphenyl	H	H	H	o-biphenyl	H	p-biphenyl
Y-93	o-biphenyl	H	H	H	o-biphenyl	p-biphenyl	p-biphenyl

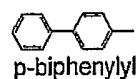
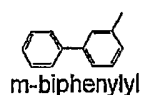
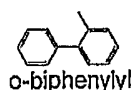
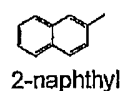
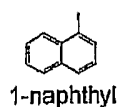
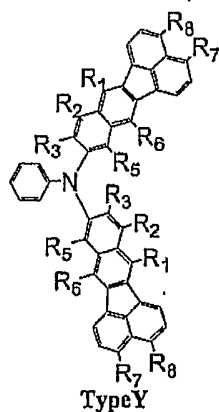

	R ₁	R ₂	R ₃	R ₅	R ₆	R ₇	R ₈
Y-94	m-biphenyl	H	H	H	m-biphenyl	H	H
Y-95	m-biphenyl	Ph	H	H	m-biphenyl	H	H
Y-96	m-biphenyl	H	H	Ph	m-biphenyl	H	H
Y-97	m-biphenyl	Ph	H	Ph	m-biphenyl	H	H
Y-98	m-biphenyl	H	Ph	H	m-biphenyl	H	H
Y-99	m-biphenyl	H	H	H	m-biphenyl	Ph	H
Y-100	m-biphenyl	H	H	H	m-biphenyl	H	Ph
Y-101	m-biphenyl	H	H	H	m-biphenyl	Ph	Ph
Y-102	m-biphenyl	H	H	H	m-biphenyl	1-naphthyl	H
Y-103	m-biphenyl	H	H	H	m-biphenyl	H	1-naphthyl
Y-104	m-biphenyl	H	H	H	m-biphenyl	1-naphthyl	1-naphthyl
Y-105	m-biphenyl	H	H	H	m-biphenyl	2-naphthyl	H
Y-106	m-biphenyl	H	H	H	m-biphenyl	H	2-naphthyl
Y-107	m-biphenyl	H	H	H	m-biphenyl	2-naphthyl	2-naphthyl
Y-108	m-biphenyl	H	H	H	m-biphenyl	o-biphenyl	H
Y-109	m-biphenyl	H	H	H	m-biphenyl	H	o-biphenyl
Y-110	m-biphenyl	H	H	H	m-biphenyl	o-biphenyl	o-biphenyl
Y-111	m-biphenyl	H	H	H	m-biphenyl	m-biphenyl	H
Y-112	m-biphenyl	H	H	H	m-biphenyl	H	m-biphenyl
Y-113	m-biphenyl	H	H	H	m-biphenyl	m-biphenyl	m-biphenyl
Y-114	m-biphenyl	H	H	H	m-biphenyl	p-biphenyl	H
Y-115	m-biphenyl	H	H	H	m-biphenyl	H	p-biphenyl
Y-116	m-biphenyl	H	H	H	m-biphenyl	p-biphenyl	p-biphenyl
Y-117	p-biphenyl	H	H	H	p-biphenyl	H	H
Y-118	p-biphenyl	Ph	H	H	p-biphenyl	H	H
Y-119	p-biphenyl	H	H	Ph	p-biphenyl	H	H
Y-120	p-biphenyl	Ph	H	Ph	p-biphenyl	H	H
Y-121	p-biphenyl	H	Ph	H	p-biphenyl	H	H
Y-122	p-biphenyl	H	H	H	p-biphenyl	Ph	H
Y-123	p-biphenyl	H	H	H	p-biphenyl	H	Ph
Y-124	p-biphenyl	H	H	H	p-biphenyl	Ph	Ph
Y-125	p-biphenyl	H	H	H	p-biphenyl	1-naphthyl	H
Y-126	p-biphenyl	H	H	H	p-biphenyl	H	1-naphthyl
Y-127	p-biphenyl	H	H	H	p-biphenyl	1-naphthyl	1-naphthyl
Y-128	p-biphenyl	H	H	H	p-biphenyl	2-naphthyl	H
Y-129	p-biphenyl	H	H	H	p-biphenyl	H	2-naphthyl
Y-130	p-biphenyl	H	H	H	p-biphenyl	2-naphthyl	2-naphthyl
Y-131	p-biphenyl	H	H	H	p-biphenyl	o-biphenyl	H
Y-132	p-biphenyl	H	H	H	p-biphenyl	H	o-biphenyl
Y-133	p-biphenyl	H	H	H	p-biphenyl	o-biphenyl	o-biphenyl
Y-134	p-biphenyl	H	H	H	p-biphenyl	m-biphenyl	H
Y-135	p-biphenyl	H	H	H	p-biphenyl	H	m-biphenyl
Y-136	p-biphenyl	H	H	H	p-biphenyl	m-biphenyl	m-biphenyl
Y-137	p-biphenyl	H	H	H	p-biphenyl	p-biphenyl	H
Y-138	p-biphenyl	H	H	H	p-biphenyl	H	p-biphenyl
Y-139	p-biphenyl	H	H	H	p-biphenyl	p-biphenyl	p-biphenyl

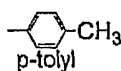
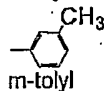
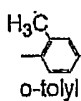
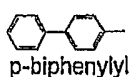
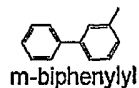
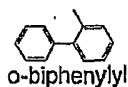
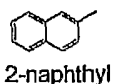
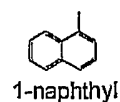
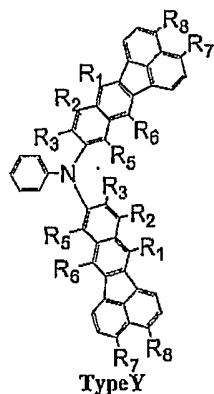

	R ₁	R ₂	R ₃	R ₅	R ₆	R ₇	R ₈
Y-140	o-tolyl	H	H	H	o-tolyl	H	H
Y-141	o-tolyl	Ph	H	Ph	o-tolyl	H	H
Y-142	o-tolyl	H	Ph	H	o-tolyl	H	H
Y-143	o-tolyl	H	H	H	o-tolyl	Ph	H
Y-144	o-tolyl	H	H	H	o-tolyl	H	Ph
Y-145	o-tolyl	H	H	H	o-tolyl	1-naphthyl	H
Y-146	o-tolyl	H	H	H	o-tolyl	H	1-naphthyl
Y-147	o-tolyl	H	H	H	o-tolyl	2-naphthyl	H
Y-148	o-tolyl	H	H	H	o-tolyl	H	2-naphthyl
Y-149	o-tolyl	H	H	H	o-tolyl	o-biphenyl	H
Y-150	o-tolyl	H	H	H	o-tolyl	H	o-biphenyl
Y-151	o-tolyl	H	H	H	o-tolyl	m-biphenyl	H
Y-152	o-tolyl	H	H	H	o-tolyl	H	m-biphenyl
Y-153	o-tolyl	H	H	H	o-tolyl	p-biphenyl	H
Y-154	o-tolyl	H	H	H	o-tolyl	H	p-biphenyl
Y-155	o-tolyl	H	H	H	o-tolyl	o-tolyl	H
Y-156	o-tolyl	H	H	H	o-tolyl	H	o-tolyl
Y-157	m-tolyl	H	H	H	m-tolyl	H	H
Y-158	m-tolyl	Ph	H	Ph	m-tolyl	H	H
Y-159	m-tolyl	H	Ph	H	m-tolyl	H	H
Y-160	m-tolyl	H	H	H	m-tolyl	Ph	H
Y-161	m-tolyl	H	H	H	m-tolyl	H	Ph
Y-162	m-tolyl	H	H	H	m-tolyl	1-naphthyl	H
Y-163	m-tolyl	H	H	H	m-tolyl	H	1-naphthyl
Y-164	m-tolyl	H	H	H	m-tolyl	2-naphthyl	H
Y-165	m-tolyl	H	H	H	m-tolyl	H	2-naphthyl
Y-166	m-tolyl	H	H	H	m-tolyl	o-biphenyl	H
Y-167	m-tolyl	H	H	H	m-tolyl	H	o-biphenyl
Y-168	m-tolyl	H	H	H	m-tolyl	m-biphenyl	H
Y-169	m-tolyl	H	H	H	m-tolyl	H	m-biphenyl
Y-170	m-tolyl	H	H	H	m-tolyl	p-biphenyl	H
Y-171	m-tolyl	H	H	H	m-tolyl	H	p-biphenyl
Y-172	m-tolyl	H	H	H	m-tolyl	m-tolyl	H
Y-173	m-tolyl	H	H	H	m-tolyl	H	m-tolyl
Y-174	p-tolyl	H	H	H	p-tolyl	H	H
Y-175	p-tolyl	Ph	H	Ph	p-tolyl	H	H
Y-176	p-tolyl	H	Ph	H	p-tolyl	H	H
Y-177	p-tolyl	H	H	H	p-tolyl	Ph	H
Y-178	p-tolyl	H	H	H	p-tolyl	H	Ph
Y-179	p-tolyl	H	H	H	p-tolyl	1-naphthyl	H
Y-180	p-tolyl	H	H	H	p-tolyl	H	1-naphthyl
Y-181	p-tolyl	H	H	H	p-tolyl	2-naphthyl	H
Y-182	p-tolyl	H	H	H	p-tolyl	H	2-naphthyl
Y-183	p-tolyl	H	H	H	p-tolyl	o-biphenyl	H
Y-184	p-tolyl	H	H	H	p-tolyl	H	o-biphenyl
Y-185	p-tolyl	H	H	H	p-tolyl	m-biphenyl	H
Y-186	p-tolyl	H	H	H	p-tolyl	H	m-biphenyl
Y-187	p-tolyl	H	H	H	p-tolyl	p-biphenyl	H
Y-188	p-tolyl	H	H	H	p-tolyl	H	p-biphenyl
Y-189	p-tolyl	H	H	H	p-tolyl	p-tolyl	H
Y-190	p-tolyl	H	H	H	p-tolyl	H	p-tolyl

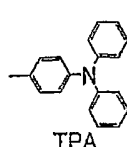
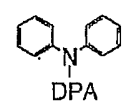
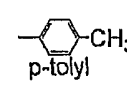
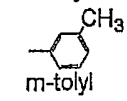
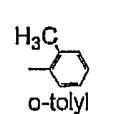
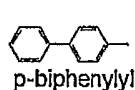
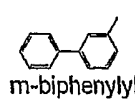
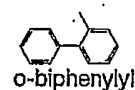
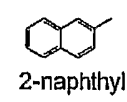
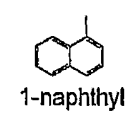
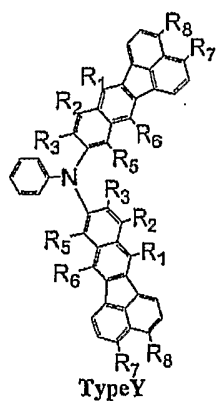

	R ₁	R ₂	R ₃	R ₅	R ₆	R ₇	R ₈
Y-191	Ph	H	-CH ₃	H	Ph	H	H
Y-192	1-naphthyl	H	-CH ₃	H	1-naphthyl	H	H
Y-193	2-naphthyl	H	-CH ₃	H	2-naphthyl	H	H
Y-194	o-biphenylyl	H	-CH ₃	H	o-biphenylyl	H	H
Y-195	m-biphenylyl	H	-CH ₃	H	m-biphenylyl	H	H
Y-196	p-biphenylyl	H	-CH ₃	H	p-biphenylyl	H	H
Y-197	o-tolyl	H	-CH ₃	H	o-tolyl	H	H
Y-198	m-tolyl	H	-CH ₃	H	m-tolyl	H	H
Y-199	p-tolyl	H	-CH ₃	H	p-tolyl	H	H
Y-200	Ph	H	H	H	Ph	-CH ₃	H
Y-201	1-naphthyl	H	H	H	1-naphthyl	-CH ₃	H
Y-202	2-naphthyl	H	H	H	2-naphthyl	-CH ₃	H
Y-203	o-biphenylyl	H	H	H	o-biphenylyl	-CH ₃	H
Y-204	m-biphenylyl	H	H	H	m-biphenylyl	-CH ₃	H
Y-205	p-biphenylyl	H	H	H	p-biphenylyl	-CH ₃	H
Y-206	o-tolyl	H	H	H	o-tolyl	-CH ₃	H
Y-207	m-tolyl	H	H	H	m-tolyl	-CH ₃	H
Y-208	p-tolyl	H	H	H	p-tolyl	-CH ₃	H
Y-209	Ph	H	H	H	Ph	H	-CH ₃
Y-210	1-naphthyl	H	H	H	1-naphthyl	H	-CH ₃
Y-211	2-naphthyl	H	H	H	2-naphthyl	H	-CH ₃
Y-212	o-biphenylyl	H	H	H	o-biphenylyl	H	-CH ₃
Y-213	m-biphenylyl	H	H	H	m-biphenylyl	H	-CH ₃
Y-214	p-biphenylyl	H	H	H	p-biphenylyl	H	-CH ₃
Y-215	o-tolyl	H	H	H	o-tolyl	H	-CH ₃
Y-216	m-tolyl	H	H	H	m-tolyl	H	-CH ₃
Y-217	p-tolyl	H	H	H	p-tolyl	H	-CH ₃
Y-218	Ph	H	H	H	Ph	-CH ₃	-CH ₃
Y-219	1-naphthyl	H	H	H	1-naphthyl	-CH ₃	-CH ₃
Y-220	2-naphthyl	H	H	H	2-naphthyl	-CH ₃	-CH ₃
Y-221	o-biphenylyl	H	H	H	o-biphenylyl	-CH ₃	-CH ₃
Y-222	m-biphenylyl	H	H	H	m-biphenylyl	-CH ₃	-CH ₃
Y-223	p-biphenylyl	H	H	H	p-biphenylyl	-CH ₃	-CH ₃
Y-224	o-tolyl	H	H	H	o-tolyl	-CH ₃	-CH ₃
Y-225	m-tolyl	H	H	H	m-tolyl	-CH ₃	-CH ₃
Y-226	p-tolyl	H	H	H	p-tolyl	-CH ₃	-CH ₃
Y-227	Ph	H	H	H	Ph	H	DPA
Y-228	1-naphthyl	H	H	H	1-naphthyl	H	DPA
Y-229	2-naphthyl	H	H	H	2-naphthyl	H	DPA
Y-230	o-biphenylyl	H	H	H	o-biphenylyl	H	DPA
Y-231	m-biphenylyl	H	H	H	m-biphenylyl	H	DPA
Y-232	p-biphenylyl	H	H	H	p-biphenylyl	H	DPA
Y-233	Ph	H	H	H	Ph	DPA	H
Y-234	1-naphthyl	H	H	H	1-naphthyl	DPA	H
Y-235	2-naphthyl	H	H	H	2-naphthyl	DPA	H
Y-236	o-biphenylyl	H	H	H	o-biphenylyl	DPA	H
Y-237	m-biphenylyl	H	H	H	m-biphenylyl	DPA	H
Y-238	p-biphenylyl	H	H	H	p-biphenylyl	DPA	H
Y-239	Ph	H	H	H	Ph	H	TPA
Y-240	1-naphthyl	H	H	H	1-naphthyl	H	TPA
Y-241	2-naphthyl	H	H	H	2-naphthyl	H	TPA
Y-242	o-biphenylyl	H	H	H	o-biphenylyl	H	TPA
Y-243	m-biphenylyl	H	H	H	m-biphenylyl	H	TPA
Y-244	p-biphenylyl	H	H	H	p-biphenylyl	H	TPA
Y-245	Ph	H	H	H	Ph	TPA	H
Y-246	1-naphthyl	H	H	H	1-naphthyl	TPA	H
Y-247	2-naphthyl	H	H	H	2-naphthyl	TPA	H
Y-248	o-biphenylyl	H	H	H	o-biphenylyl	TPA	H
Y-249	m-biphenylyl	H	H	H	m-biphenylyl	TPA	H
Y-250	p-biphenylyl	H	H	H	p-biphenylyl	TPA	H

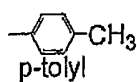
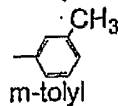
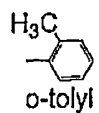
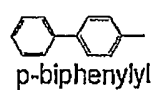
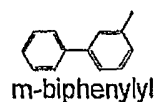
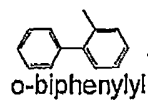
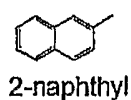
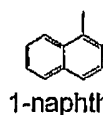
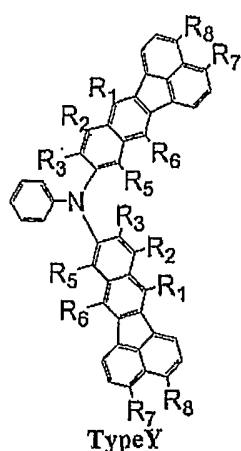

	R ₁	R ₂	R ₃	R ₅	R ₆	R ₇	R ₈
Y-251	Ph	H	H	H	1-naphthyl	H	H
Y-252	Ph	H	H	H	2-naphthyl	H	H
Y-253	Ph	H	H	H	o-biphenyl	H	H
Y-254	Ph	H	H	H	m-biphenyl	H	H
Y-255	Ph	H	H	H	p-biphenyl	H	H
Y-256	Ph	H	H	H	O-tolyl	H	H
Y-257	Ph	H	H	H	m-tolyl	H	H
Y-258	Ph	H	H	H	p-tolyl	H	H
Y-259	1-naphthyl	H	H	H	2-naphthyl	H	H
Y-260	1-naphthyl	H	H	H	o-biphenyl	H	H
Y-261	1-naphthyl	H	H	H	m-biphenyl	H	H
Y-262	1-naphthyl	H	H	H	p-biphenyl	H	H
Y-263	1-naphthyl	H	H	H	O-tolyl	H	H
Y-264	1-naphthyl	H	H	H	m-tolyl	H	H
Y-265	1-naphthyl	H	H	H	p-tolyl	H	H
Y-266	2-naphthyl	H	H	H	o-biphenyl	H	H
Y-267	2-naphthyl	H	H	H	m-biphenyl	H	H
Y-268	2-naphthyl	H	H	H	p-biphenyl	H	H
Y-269	2-naphthyl	H	H	H	O-tolyl	H	H
Y-270	2-naphthyl	H	H	H	m-tolyl	H	H
Y-271	2-naphthyl	H	H	H	p-tolyl	H	H
Y-272	o-biphenyl	H	H	H	m-biphenyl	H	H
Y-273	o-biphenyl	H	H	H	p-biphenyl	H	H
Y-274	o-biphenyl	H	H	H	O-tolyl	H	H
Y-275	o-biphenyl	H	H	H	m-tolyl	H	H
Y-276	o-biphenyl	H	H	H	p-tolyl	H	H
Y-277	m-biphenyl	H	H	H	p-biphenyl	H	H
Y-278	m-biphenyl	H	H	H	O-tolyl	H	H
Y-279	m-biphenyl	H	H	H	m-tolyl	H	H
Y-280	m-biphenyl	H	H	H	p-tolyl	H	H
Y-281	p-biphenyl	H	H	H	O-tolyl	H	H
Y-282	p-biphenyl	H	H	H	m-tolyl	H	H
Y-283	p-biphenyl	H	H	H	p-tolyl	H	H
Y-284	O-tolyl	H	H	H	m-tolyl	H	H
Y-285	O-tolyl	H	H	H	p-tolyl	H	H
Y-286	m-tolyl	H	H	H	p-tolyl	H	H

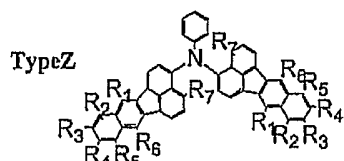

	R ₁	R ₂	R ₃	R ₄	R ₅	R ₆	R ₇
Z-1	H	H	H	H	H	H	H
Z-2	Ph	H	H	H	H	Ph	H
Z-3	Ph	Ph	H	H	Ph	Ph	H
Z-4	Ph	H	Ph	Ph	H	Ph	H
Z-5	Ph	H	Ph	H	H	Ph	H
Z-6	Ph	H	H	H	H	Ph	Ph
Z-7	Ph	Me	H	H	Me	Ph	H
Z-8	Ph	H	Me	Me	H	Ph	H
Z-9	Ph	H	H	H	H	Ph	Me
Z-10		H	H	H	H		H
Z-11		Ph	H	H	Ph		H
Z-12		H	Ph	Ph	H		H
Z-13		H	Ph	H	H		H
Z-14		H	H	H	H		Ph
Z-15		Me	H	H	Me		H
Z-16		H	Me	Me	H		H
Z-17		H	H	H	H		Me
Z-18		H	H	H	H		H
Z-19		Ph	H	H	Ph		H
Z-20		H	Ph	Ph	H		H
Z-21		H	Ph	H	H		H
Z-22		H	H	H	H		Ph
Z-23		Me	H	H	Me		H
Z-24		H	Me	Me	H		H
Z-25		H	H	H	H		Me

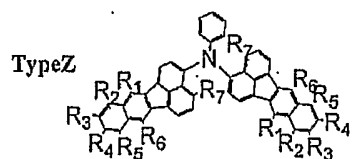

	R ₁	R ₂	R ₃	R ₄	R ₅	R ₆	R ₇
Z-26		H	H	H	H		H
Z-27		Ph	H	H	Ph		H
Z-28		H	Ph	Ph	H		H
Z-29		H	Ph	H	H		H
Z-30		H	H	H	H		Ph
Z-31		Me	H	H	Me		H
Z-32		H	Me	Me	H		H
Z-33		H	H	H	H		Me
Z-34		H	H	H	H		H
Z-35		Ph	H	H	Ph		H
Z-36		H	Ph	Ph	H		H
Z-37		H	Ph	H	H		H
Z-38		H	H	H	H		Ph
Z-39		Me	H	H	Me		H
Z-40		H	Me	Me	H		H
Z-41		H	H	H	H		Me
Z-42		H	H	H	H		H
Z-43		Ph	H	H	Ph		H
Z-44		H	Ph	Ph	H		H
Z-45		H	Ph	H	H		H
Z-46		H	H	H	H		Ph
Z-47		Me	H	H	Me		H
Z-48		H	Me	Me	H		H
Z-49		H	H	H	H		Me

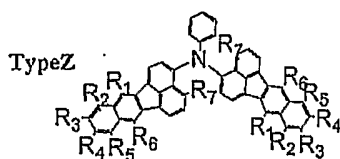

	R ₁	R ₂	R ₃	R ₄	R ₅	R ₆	R ₇
Z-50	Ph	H	H	H	H		H
Z-51	Ph	H	H	H	H		H
Z-52	Ph	H	H	H	H		H
Z-53	Ph	H	H	H	H		H
Z-54	Ph	H	H	H	H		H
Z-55		H	H	H	H		H
Z-56		H	H	H	H		H
Z-57		H	H	H	H		H
Z-58		H	H	H	H		H
Z-59		H	H	H	H		H
Z-60		H	H	H	H		H
Z-61		H	H	H	H		H
Z-62		H	H	H	H		H
Z-63		H	H	H	H		H
Z-64		H	H	H	H		H
Z-65	H	Ph	H	H	Ph	H	H
Z-66	H		H	H		H	H
Z-67	H		H	H		H	H
Z-68	H		H	H		H	H
Z-69	H		H	H		H	H
Z-70	H		H	H		H	H
Z-71	H	H			H	H	H
Z-72	H	H			H	H	H
Z-73	H	H			H	H	H
Z-74	H	H			H	H	H
Z-75	H	H			H	H	H

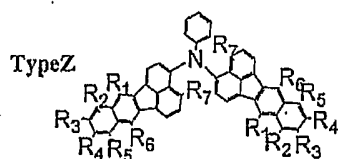

	R ₁	R ₂	R ₃	R ₄	R ₅	R ₆	R ₇
Z-76		H	H	H	H		H
Z-77		Ph	H	H	Ph		H
Z-78		H	Ph	Ph	H		H
Z-79		H	Ph	H	H		H
Z-80		H	H	H	H		Ph
Z-81		Me	H	H	Me		H
Z-82		H	Me	Me	H		H
Z-83		H	H	H	H		Me
Z-84		H	H	H	H		H
Z-85		Ph	H	H	Ph		H
Z-86		H	Ph	Ph	H		H
Z-87		H	Ph	H	H		H
Z-88		H	H	H	H		Ph
Z-89		Me	H	H	Me		H
Z-90		H	Me	Me	H		H
Z-91		H	H	H	H		Me
Z-92		H	H	H	H		H
Z-93		Ph	H	H	Ph		H
Z-94		H	Ph	Ph	H		H
Z-96		H	Ph	H	H		H
Z-96		H	H	H	H		Ph
Z-97		Me	H	H	Me		H
Z-98		H	Me	Me	H		H
Z-99		H	H	H	H		Me

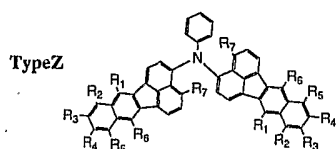

	R ₁	R ₂	R ₃	R ₄	R ₅	R ₆	R ₇
100		H	H	H	H		H
101		Ph	H	H	Ph		H
102		H	Ph	Ph	H		H
103		H	Ph	H	H		H
104		H	H	H	H		Ph
105		Me	H	H	Me		H
106		H	Me	Me	H		H
107		H	H	H	H		Me
108		H	H	H	H		H
109		Ph	H	H	Ph		H
110		H	Ph	Ph	H		H
111		H	Ph	H	H		H
112		H	H	H	H		Ph
113		Me	H	H	Me		H
114		H	Me	Me	H		H
115		H	H	H	H		Me
116		H	H	H	H		H
117		Ph	H	H	Ph		H
118		H	Ph	Ph	H		H
119		H	Ph	H	H		H
120		H	H	H	H		Ph
121		Me	H	H	Me		H
122		H	Me	Me	H		H
123		H	H	H	H		Me

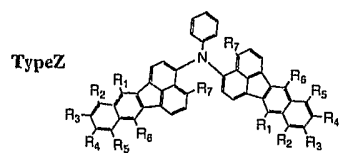

	R ₁	R ₂	R ₃	R ₄	R ₅	R ₆	R ₇
124		H	H	H	H		H
125		Ph	H	H	Ph		H
126		H	Ph	Ph	H		H
127		H	Ph	H	H		H
128		H	H	H	H		Ph
129		Me	H	H	Me		H
130		H	Me	Me	H		H
131		H	H	H	H		Me
132		H	H	H	H		H
133		Ph	H	H	Ph		H
134		H	Ph	Ph	H		H
135		H	Ph	H	H		H
136		H	H	H	H		Ph
137		Me	H	H	Me		H
138		H	Me	Me	H		H
139		H	H	H	H		Me
140		H	H	H	H		H
141		Ph	H	H	Ph		H
142		H	Ph	Ph	H		H
143		H	Ph	H	H		H
144		H	H	H	H		Ph
145		Me	H	H	Me		H
146		H	Me	Me	H		H
147		H	H	H	H		Me

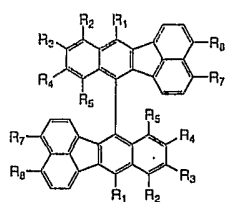

TypeAAA



1-naphthyl



2-naphthyl

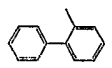

o-biphenyl

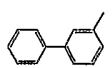

m-biphenyl

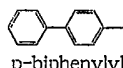

p-biphenyl

	R ₁	R ₂	R ₃	R ₄	R ₅	R ₇	R ₈
1	H	H	H	H	H	H	H
2	Ph	H	H	H	H	H	H
3	Ph	Ph	H	H	Ph	H	H
4	Ph	H	Ph	Ph	H	H	H
5	Ph	H	Ph	H	H	H	H
6	Ph	H	H	Ph	H	H	H
7	Ph	H	H	H	H	Ph	H
8	Ph	H	H	H	H	H	Ph
9	Ph	H	H	H	H	Ph	Ph
10	Ph	H	H	H	H	1-naphthyl	H
11	Ph	H	H	H	H	H	1-naphthyl
12	Ph	H	H	H	H	1-naphthyl	1-naphthyl
13	Ph	H	H	H	H	2-naphthyl	H
14	Ph	H	H	H	H	H	2-naphthyl
15	Ph	H	H	H	H	2-naphthyl	2-naphthyl
16	Ph	H	H	H	H	o-biphenyl	H
17	Ph	H	H	H	H	H	o-biphenyl
18	Ph	H	H	H	H	o-biphenyl	o-biphenyl
19	Ph	H	H	H	H	m-biphenyl	H
20	Ph	H	H	H	H	H	m-biphenyl
21	Ph	H	H	H	H	m-biphenyl	m-biphenyl
22	Ph	H	H	H	H	p-biphenyl	H
23	Ph	H	H	H	H	H	p-biphenyl
24	Ph	H	H	H	H	p-biphenyl	p-biphenyl
25	1-naphthyl	H	H	H	H	H	H
26	1-naphthyl	Ph	H	H	Ph	H	H
27	1-naphthyl	H	Ph	Ph	H	H	H
28	1-naphthyl	H	Ph	H	H	H	H
29	1-naphthyl	H	H	Ph	H	H	H
30	1-naphthyl	H	H	H	H	Ph	H
31	1-naphthyl	H	H	H	H	H	Ph
32	1-naphthyl	H	H	H	H	Ph	Ph
33	1-naphthyl	H	H	H	H	1-naphthyl	H
34	1-naphthyl	H	H	H	H	H	1-naphthyl
35	1-naphthyl	H	H	H	H	1-naphthyl	1-naphthyl
36	1-naphthyl	H	H	H	H	2-naphthyl	H
37	1-naphthyl	H	H	H	H	H	2-naphthyl
38	1-naphthyl	H	H	H	H	2-naphthyl	2-naphthyl
39	1-naphthyl	H	H	H	H	o-biphenyl	H
40	1-naphthyl	H	H	H	H	H	o-biphenyl
41	1-naphthyl	H	H	H	H	o-biphenyl	o-biphenyl
42	1-naphthyl	H	H	H	H	m-biphenyl	H
43	1-naphthyl	H	H	H	H	H	m-biphenyl
44	1-naphthyl	H	H	H	H	m-biphenyl	m-biphenyl
45	1-naphthyl	H	H	H	H	p-biphenyl	H
46	1-naphthyl	H	H	H	H	H	p-biphenyl
47	1-naphthyl	H	H	H	H	p-biphenyl	p-biphenyl

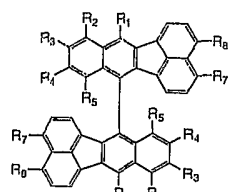

Type AAA

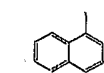

1-naphthyl



2-naphthyl

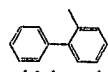

o-biphenyl

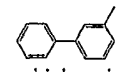

m-biphenyl

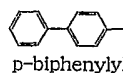

p-biphenyl

	R ₁	R ₂	R ₃	R ₄	R ₅	R ₇	R ₈
48	2-naphthyl	H	H	H	H	H	H
49	2-naphthyl	Ph	H	H	Ph	H	H
50	2-naphthyl	H	Ph	Ph	H	H	H
51	2-naphthyl	H	Ph	H	H	H	H
52	2-naphthyl	H	H	Ph	H	H	H
53	2-naphthyl	H	H	H	H	Ph	H
54	2-naphthyl	H	H	H	H	H	Ph
55	2-naphthyl	H	H	H	H	Ph	Ph
56	2-naphthyl	H	H	H	H	1-naphthyl	H
57	2-naphthyl	H	H	H	H	H	1-naphthyl
58	2-naphthyl	H	H	H	H	1-naphthyl	1-naphthyl
59	2-naphthyl	H	H	H	H	2-naphthyl	H
60	2-naphthyl	H	H	H	H	H	2-naphthyl
61	2-naphthyl	H	H	H	H	2-naphthyl	2-naphthyl
62	2-naphthyl	H	H	H	H	o-biphenyl	H
63	2-naphthyl	H	H	H	H	H	o-biphenyl
64	2-naphthyl	H	H	H	H	o-biphenyl	o-biphenyl
65	2-naphthyl	H	H	H	H	m-biphenyl	H
66	2-naphthyl	H	H	H	H	H	m-biphenyl
67	2-naphthyl	H	H	H	H	m-biphenyl	m-biphenyl
68	2-naphthyl	H	H	H	H	p-biphenyl	H
69	2-naphthyl	H	H	H	H	H	p-biphenyl
70	2-naphthyl	H	H	H	H	p-biphenyl	p-biphenyl
71	o-biphenyl	H	H	H	H	H	H
72	o-biphenyl	Ph	H	H	Ph	H	H
73	o-biphenyl	H	Ph	Ph	H	H	H
74	o-biphenyl	H	Ph	H	H	H	H
75	o-biphenyl	H	H	Ph	H	H	H
76	o-biphenyl	H	H	H	H	Ph	H
77	o-biphenyl	H	H	H	H	H	Ph
78	o-biphenyl	H	H	H	H	Ph	Ph
79	o-biphenyl	H	H	H	H	1-naphthyl	H
80	o-biphenyl	H	H	H	H	H	1-naphthyl
81	o-biphenyl	H	H	H	H	1-naphthyl	1-naphthyl
82	o-biphenyl	H	H	H	H	2-naphthyl	H
83	o-biphenyl	H	H	H	H	H	2-naphthyl
84	o-biphenyl	H	H	H	H	2-naphthyl	2-naphthyl
85	o-biphenyl	H	H	H	H	o-biphenyl	H
86	o-biphenyl	H	H	H	H	H	o-biphenyl
87	o-biphenyl	H	H	H	H	o-biphenyl	o-biphenyl
88	o-biphenyl	H	H	H	H	m-biphenyl	H
89	o-biphenyl	H	H	H	H	H	m-biphenyl
90	o-biphenyl	H	H	H	H	m-biphenyl	m-biphenyl
91	o-biphenyl	H	H	H	H	p-biphenyl	H
92	o-biphenyl	H	H	H	H	H	p-biphenyl
93	o-biphenyl	H	H	H	H	p-biphenyl	p-biphenyl

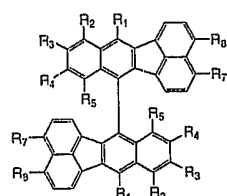

TypeAAA

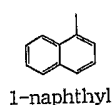

1-naphthyl

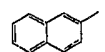

2-naphthyl

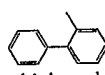

o-biphenyl

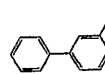

m-biphenyl

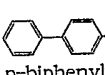

p-biphenyl

	R ₁	R ₂	R ₃	R ₄	R ₅	R ₇	R ₈
94	m-biphenyl	H	H	H	H	H	H
95	m-biphenyl	Ph	H	H	Ph	H	H
96	m-biphenyl	H	Ph	Ph	H	H	H
97	m-biphenyl	H	Ph	H	H	H	H
98	m-biphenyl	H	H	Ph	H	H	H
99	m-biphenyl	H	H	H	H	Ph	H
100	m-biphenyl	H	H	H	H	H	Ph
101	m-biphenyl	H	H	H	H	Ph	Ph
102	m-biphenyl	H	H	H	H	1-naphthyl	H
103	m-biphenyl	H	H	H	H	H	1-naphthyl
104	m-biphenyl	H	H	H	H	1-naphthyl	1-naphthyl
105	m-biphenyl	H	H	H	H	2-naphthyl	H
106	m-biphenyl	H	H	H	H	H	2-naphthyl
107	m-biphenyl	H	H	H	H	2-naphthyl	2-naphthyl
108	m-biphenyl	H	H	H	H	o-biphenyl	H
109	m-biphenyl	H	H	H	H	H	o-biphenyl
110	m-biphenyl	H	H	H	H	o-biphenyl	o-biphenyl
111	m-biphenyl	H	H	H	H	m-biphenyl	H
112	m-biphenyl	H	H	H	H	H	m-biphenyl
113	m-biphenyl	H	H	H	H	m-biphenyl	m-biphenyl
114	m-biphenyl	H	H	H	H	p-biphenyl	H
115	m-biphenyl	H	H	H	H	H	p-biphenyl
116	m-biphenyl	H	H	H	H	p-biphenyl	p-biphenyl
117	p-biphenyl	H	H	H	H	H	H
118	p-biphenyl	Ph	H	H	Ph	H	H
119	p-biphenyl	H	Ph	Ph	H	H	H
120	p-biphenyl	H	Ph	H	H	H	H
121	p-biphenyl	H	H	Ph	H	H	H
122	p-biphenyl	H	H	H	H	Ph	H
123	p-biphenyl	H	H	H	H	H	Ph
124	p-biphenyl	H	H	H	H	Ph	Ph
125	p-biphenyl	H	H	H	H	1-naphthyl	H
126	p-biphenyl	H	H	H	H	H	1-naphthyl
127	p-biphenyl	H	H	H	H	1-naphthyl	1-naphthyl
128	p-biphenyl	H	H	H	H	2-naphthyl	H
129	p-biphenyl	H	H	H	H	H	2-naphthyl
130	p-biphenyl	H	H	H	H	2-naphthyl	2-naphthyl
131	p-biphenyl	H	H	H	H	o-biphenyl	H
132	p-biphenyl	H	H	H	H	H	o-biphenyl
133	p-biphenyl	H	H	H	H	o-biphenyl	o-biphenyl
134	p-biphenyl	H	H	H	H	m-biphenyl	H
135	p-biphenyl	H	H	H	H	H	m-biphenyl
136	p-biphenyl	H	H	H	H	m-biphenyl	m-biphenyl
137	p-biphenyl	H	H	H	H	p-biphenyl	H
138	p-biphenyl	H	H	H	H	H	p-biphenyl
139	p-biphenyl	H	H	H	H	p-biphenyl	p-biphenyl

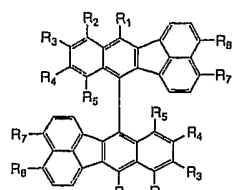

TypeAAA

	R ₁	R ₂	R ₃	R ₄	R ₅	R ₇	R ₈
140	o-tolyl	H	H	H	H	H	H
141	o-tolyl	Ph	H	H	Ph	H	H
142	o-tolyl	H	Ph	Ph	H	H	H
143	o-tolyl	H	H	H	H	Ph	H
144	o-tolyl	H	H	H	H	H	Ph
145	o-tolyl	H	H	H	H	1-naphthyl	H
146	o-tolyl	H	H	H	H	H	1-naphthyl
147	o-tolyl	H	H	H	H	2-naphthyl	H
148	o-tolyl	H	H	H	H	H	2-naphthyl
149	o-tolyl	H	H	H	H	o-biphenyl	H
150	o-tolyl	H	H	H	H	H	o-biphenyl
151	o-tolyl	H	H	H	H	m-biphenyl	H
152	o-tolyl	H	H	H	H	H	m-biphenyl
153	o-tolyl	H	H	H	H	p-biphenyl	H
154	o-tolyl	H	H	H	H	H	p-biphenyl
155	o-tolyl	H	H	H	H	o-tolyl	H
156	o-tolyl	H	H	H	H	H	o-tolyl
157	m-tolyl	H	H	H	H	H	H
158	m-tolyl	Ph	H	H	Ph	H	H
159	m-tolyl	H	Ph	Ph	H	H	H
160	m-tolyl	H	H	H	H	Ph	H
161	m-tolyl	H	H	H	H	H	Ph
162	m-tolyl	H	H	H	H	1-naphthyl	H
163	m-tolyl	H	H	H	H	H	1-naphthyl
164	m-tolyl	H	H	H	H	2-naphthyl	H
165	m-tolyl	H	H	H	H	H	2-naphthyl
166	m-tolyl	H	H	H	H	o-biphenyl	H
167	m-tolyl	H	H	H	H	H	o-biphenyl
168	m-tolyl	H	H	H	H	m-biphenyl	H
169	m-tolyl	H	H	H	H	H	m-biphenyl
170	m-tolyl	H	H	H	H	p-biphenyl	H
171	m-tolyl	H	H	H	H	H	p-biphenyl
172	m-tolyl	H	H	H	H	m-tolyl	H
173	m-tolyl	H	H	H	H	H	m-tolyl
174	p-tolyl	H	H	H	H	H	H
175	p-tolyl	Ph	H	H	Ph	H	H
176	p-tolyl	H	Ph	Ph	H	H	H
177	p-tolyl	H	H	H	H	Ph	H
178	p-tolyl	H	H	H	H	H	Ph
179	p-tolyl	H	H	H	H	1-naphthyl	H
180	p-tolyl	H	H	H	H	H	1-naphthyl
181	p-tolyl	H	H	H	H	2-naphthyl	H
182	p-tolyl	H	H	H	H	H	2-naphthyl
183	p-tolyl	H	H	H	H	o-biphenyl	H
184	p-tolyl	H	H	H	H	H	o-biphenyl
185	p-tolyl	H	H	H	H	m-biphenyl	H
186	p-tolyl	H	H	H	H	H	m-biphenyl
187	p-tolyl	H	H	H	H	p-biphenyl	H
188	p-tolyl	H	H	H	H	H	p-biphenyl
189	p-tolyl	H	H	H	H	p-tolyl	H
190	p-tolyl	H	H	H	H	H	p-tolyl

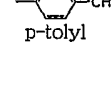
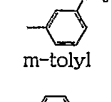
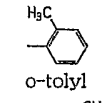
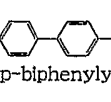
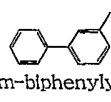
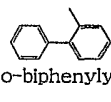
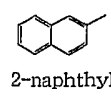
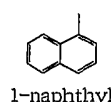

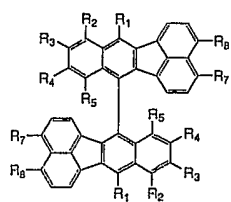

TypeAAA

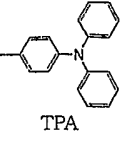
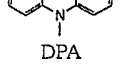
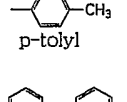
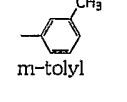
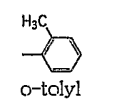
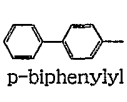
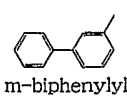
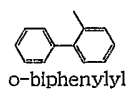
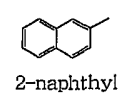
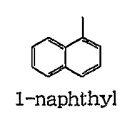

	R ₁	R ₂	R ₃	R ₄	R ₅	R ₇	R ₈
191	Ph	H	-CH ₃	-CH ₃	H	H	H
192	1-naphthyl	H	-CH ₃	-CH ₃	H	H	H
193	2-naphthyl	H	-CH ₃	-CH ₃	H	H	H
194	o-biphenyl	H	-CH ₃	-CH ₃	H	H	H
195	m-biphenyl	H	-CH ₃	-CH ₃	H	H	H
196	p-biphenyl	H	-CH ₃	-CH ₃	H	H	H
197	o-tolyl	H	-CH ₃	-CH ₃	H	H	H
198	m-tolyl	H	-CH ₃	-CH ₃	H	H	H
199	p-tolyl	H	-CH ₃	-CH ₃	H	H	H
200	Ph	H	H	H	H	-CH ₃	H
201	1-naphthyl	H	H	H	H	-CH ₃	H
202	2-naphthyl	H	H	H	H	-CH ₃	H
203	o-biphenyl	H	H	H	H	-CH ₃	H
204	m-biphenyl	H	H	H	H	-CH ₃	H
205	p-biphenyl	H	H	H	H	-CH ₃	H
206	o-tolyl	H	H	H	H	-CH ₃	H
207	m-tolyl	H	H	H	H	-CH ₃	H
208	p-tolyl	H	H	H	H	-CH ₃	H
209	Ph	H	H	H	H	H	-CH ₃
210	1-naphthyl	H	H	H	H	H	-CH ₃
211	2-naphthyl	H	H	H	H	H	-CH ₃
212	o-biphenyl	H	H	H	H	H	-CH ₃
213	m-biphenyl	H	H	H	H	H	-CH ₃
214	p-biphenyl	H	H	H	H	H	-CH ₃
215	o-tolyl	H	H	H	H	H	-CH ₃
216	m-tolyl	H	H	H	H	H	-CH ₃
217	p-tolyl	H	H	H	H	H	-CH ₃
218	Ph	H	H	H	H	-CH ₃	-CH ₃
219	1-naphthyl	H	H	H	H	-CH ₃	-CH ₃
220	2-naphthyl	H	H	H	H	-CH ₃	-CH ₃
221	o-biphenyl	H	H	H	H	-CH ₃	-CH ₃
222	m-biphenyl	H	H	H	H	-CH ₃	-CH ₃
223	p-biphenyl	H	H	H	H	-CH ₃	-CH ₃
224	o-tolyl	H	H	H	H	-CH ₃	-CH ₃
225	m-tolyl	H	H	H	H	-CH ₃	-CH ₃
226	p-tolyl	H	H	H	H	-CH ₃	-CH ₃
227	Ph	H	H	H	H	H	DPA
228	1-naphthyl	H	H	H	H	H	DPA
229	2-naphthyl	H	H	H	H	H	DPA
230	o-biphenyl	H	H	H	H	H	DPA
231	m-biphenyl	H	H	H	H	H	DPA
232	p-biphenyl	H	H	H	H	H	DPA
233	Ph	H	H	H	H	DPA	H
234	1-naphthyl	H	H	H	H	DPA	H
235	2-naphthyl	H	H	H	H	DPA	H
236	o-biphenyl	H	H	H	H	DPA	H
237	m-biphenyl	H	H	H	H	DPA	H
238	p-biphenyl	H	H	H	H	DPA	H
239	Ph	H	H	H	H	H	TPA
240	1-naphthyl	H	H	H	H	H	TPA
241	2-naphthyl	H	H	H	H	H	TPA
242	o-biphenyl	H	H	H	H	H	TPA
243	m-biphenyl	H	H	H	H	H	TPA
244	p-biphenyl	H	H	H	H	H	TPA
245	Ph	H	H	H	H	TPA	H
246	1-naphthyl	H	H	H	H	TPA	H
247	2-naphthyl	H	H	H	H	TPA	H
248	o-biphenyl	H	H	H	H	TPA	H
249	m-biphenyl	H	H	H	H	TPA	H
250	p-biphenyl	H	H	H	H	TPA	H

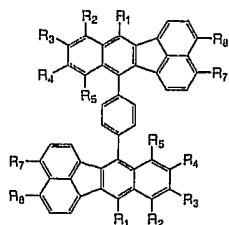

TypeBBB

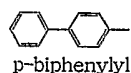
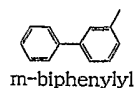
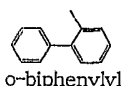
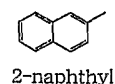
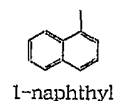

	R ₁	R ₂	R ₃	R ₄	R ₅	R ₇	R ₈
1	H	H	H	H	H	H	H
2	Ph	H	H	H	H	H	H
3	Ph	Ph	H	H	Ph	H	H
4	Ph	H	Ph	Ph	H	H	H
5	Ph	H	Ph	H	H	H	H
6	Ph	H	H	Ph	H	H	H
7	Ph	H	H	H	H	Ph	H
8	Ph	H	H	H	H	H	Ph
9	Ph	H	H	H	H	Ph	Ph
10	Ph	H	H	H	H	1-naphthyl	H
11	Ph	H	H	H	H	H	1-naphthyl
12	Ph	H	H	H	H	1-naphthyl	1-naphthyl
13	Ph	H	H	H	H	2-naphthyl	H
14	Ph	H	H	H	H	H	2-naphthyl
15	Ph	H	H	H	H	2-naphthyl	2-naphthyl
16	Ph	H	H	H	H	o-biphenyl	H
17	Ph	H	H	H	H	H	o-biphenyl
18	Ph	H	H	H	H	o-biphenyl	o-biphenyl
19	Ph	H	H	H	H	m-biphenyl	H
20	Ph	H	H	H	H	H	m-biphenyl
21	Ph	H	H	H	H	m-biphenyl	m-biphenyl
22	Ph	H	H	H	H	p-biphenyl	H
23	Ph	H	H	H	H	H	p-biphenyl
24	Ph	H	H	H	H	p-biphenyl	p-biphenyl
25	1-naphthyl	H	H	H	H	H	H
26	1-naphthyl	Ph	H	H	Ph	H	H
27	1-naphthyl	H	Ph	Ph	H	H	H
28	1-naphthyl	H	Ph	H	H	H	H
29	1-naphthyl	H	H	Ph	H	H	H
30	1-naphthyl	H	H	H	H	Ph	H
31	1-naphthyl	H	H	H	H	H	Ph
32	1-naphthyl	H	H	H	H	Ph	Ph
33	1-naphthyl	H	H	H	H	1-naphthyl	H
34	1-naphthyl	H	H	H	H	H	1-naphthyl
35	1-naphthyl	H	H	H	H	1-naphthyl	1-naphthyl
36	1-naphthyl	H	H	H	H	2-naphthyl	H
37	1-naphthyl	H	H	H	H	H	2-naphthyl
38	1-naphthyl	H	H	H	H	2-naphthyl	2-naphthyl
39	1-naphthyl	H	H	H	H	o-biphenyl	H
40	1-naphthyl	H	H	H	H	H	o-biphenyl
41	1-naphthyl	H	H	H	H	o-biphenyl	o-biphenyl
42	1-naphthyl	H	H	H	H	m-biphenyl	H
43	1-naphthyl	H	H	H	H	H	m-biphenyl
44	1-naphthyl	H	H	H	H	m-biphenyl	m-biphenyl
45	1-naphthyl	H	H	H	H	p-biphenyl	H
46	1-naphthyl	H	H	H	H	H	p-biphenyl
47	1-naphthyl	H	H	H	H	p-biphenyl	p-biphenyl

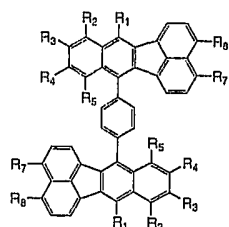

TypeBBB

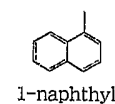

1-naphthyl

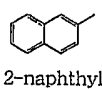

2-naphthyl

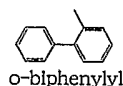

o-biphenyl

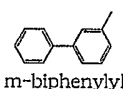

m-biphenyl

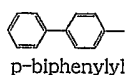

p-biphenyl

	R ₁	R ₂	R ₃	R ₄	R ₅	R ₇	R ₈
48	2-naphthyl	H	H	H	H	H	H
49	2-naphthyl	Ph	H	H	Ph	H	H
50	2-naphthyl	H	Ph	Ph	H	H	H
51	2-naphthyl	H	Ph	H	H	H	H
52	2-naphthyl	H	H	Ph	H	H	H
53	2-naphthyl	H	H	H	H	Ph	H
54	2-naphthyl	H	H	H	H	H	Ph
55	2-naphthyl	H	H	H	H	Ph	Ph
56	2-naphthyl	H	H	H	H	1-naphthyl	H
57	2-naphthyl	H	H	H	H	H	1-naphthyl
58	2-naphthyl	H	H	H	H	1-naphthyl	1-naphthyl
59	2-naphthyl	H	H	H	H	2-naphthyl	H
60	2-naphthyl	H	H	H	H	H	2-naphthyl
61	2-naphthyl	H	H	H	H	2-naphthyl	2-naphthyl
62	2-naphthyl	H	H	H	H	o-biphenyl	H
63	2-naphthyl	H	H	H	H	H	o-biphenyl
64	2-naphthyl	H	H	H	H	o-biphenyl	o-biphenyl
65	2-naphthyl	H	H	H	H	m-biphenyl	H
66	2-naphthyl	H	H	H	H	H	m-biphenyl
67	2-naphthyl	H	H	H	H	m-biphenyl	m-biphenyl
68	2-naphthyl	H	H	H	H	p-biphenyl	H
69	2-naphthyl	H	H	H	H	H	p-biphenyl
70	2-naphthyl	H	H	H	H	p-biphenyl	p-biphenyl
71	o-biphenyl	H	H	H	H	H	H
72	o-biphenyl	Ph	H	H	Ph	H	H
73	o-biphenyl	H	Ph	Ph	H	H	H
74	o-biphenyl	H	Ph	H	H	H	H
75	o-biphenyl	H	H	Ph	H	H	H
76	o-biphenyl	H	H	H	H	Ph	H
77	o-biphenyl	H	H	H	H	H	Ph
78	o-biphenyl	H	H	H	H	Ph	Ph
79	o-biphenyl	H	H	H	H	1-naphthyl	H
80	o-biphenyl	H	H	H	H	H	1-naphthyl
81	o-biphenyl	H	H	H	H	1-naphthyl	1-naphthyl
82	o-biphenyl	H	H	H	H	2-naphthyl	H
83	o-biphenyl	H	H	H	H	H	2-naphthyl
84	o-biphenyl	H	H	H	H	2-naphthyl	2-naphthyl
85	o-biphenyl	H	H	H	H	o-biphenyl	H
86	o-biphenyl	H	H	H	H	H	o-biphenyl
87	o-biphenyl	H	H	H	H	o-biphenyl	o-biphenyl
88	o-biphenyl	H	H	H	H	m-biphenyl	H
89	o-biphenyl	H	H	H	H	H	m-biphenyl
90	o-biphenyl	H	H	H	H	m-biphenyl	m-biphenyl
91	o-biphenyl	H	H	H	H	p-biphenyl	H
92	o-biphenyl	H	H	H	H	H	p-biphenyl
93	o-biphenyl	H	H	H	H	p-biphenyl	p-biphenyl

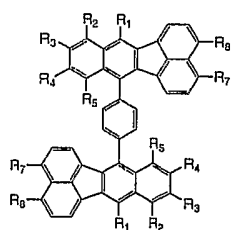

TypeBBB

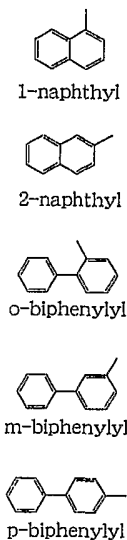

	R1	R2	R3	R4	R5	R7	R8
94	m-biphenyl	H	H	H	H	H	H
95	m-biphenyl	Ph	H	H	Ph	H	H
96	m-biphenyl	H	Ph	Ph	H	H	H
97	m-biphenyl	H	Ph	H	H	H	H
98	m-biphenyl	H	H	Ph	H	H	H
99	m-biphenyl	H	H	H	H	Ph	H
100	m-biphenyl	H	H	H	H	H	Ph
101	m-biphenyl	H	H	H	H	Ph	Ph
102	m-biphenyl	H	H	H	H	1-naphthyl	H
103	m-biphenyl	H	H	H	H	H	1-naphthyl
104	m-biphenyl	H	H	H	H	1-naphthyl	1-naphthyl
105	m-biphenyl	H	H	H	H	2-naphthyl	H
106	m-biphenyl	H	H	H	H	H	2-naphthyl
107	m-biphenyl	H	H	H	H	2-naphthyl	2-naphthyl
108	m-biphenyl	H	H	H	H	o-biphenyl	H
109	m-biphenyl	H	H	H	H	H	o-biphenyl
110	m-biphenyl	H	H	H	H	o-biphenyl	o-biphenyl
111	m-biphenyl	H	H	H	H	m-biphenyl	H
112	m-biphenyl	H	H	H	H	H	m-biphenyl
113	m-biphenyl	H	H	H	H	m-biphenyl	m-biphenyl
114	m-biphenyl	H	H	H	H	p-biphenyl	H
115	m-biphenyl	H	H	H	H	H	p-biphenyl
116	m-biphenyl	H	H	H	H	p-biphenyl	p-biphenyl
117	p-biphenyl	H	H	H	H	H	H
118	p-biphenyl	Ph	H	H	Ph	H	H
119	p-biphenyl	H	Ph	Ph	H	H	H
120	p-biphenyl	H	Ph	H	H	H	H
121	p-biphenyl	H	H	Ph	H	H	H
122	p-biphenyl	H	H	H	H	Ph	H
123	p-biphenyl	H	H	H	H	H	Ph
124	p-biphenyl	H	H	H	H	Ph	Ph
125	p-biphenyl	H	H	H	H	1-naphthyl	H
126	p-biphenyl	H	H	H	H	H	1-naphthyl
127	p-biphenyl	H	H	H	H	1-naphthyl	1-naphthyl
128	p-biphenyl	H	H	H	H	2-naphthyl	H
129	p-biphenyl	H	H	H	H	H	2-naphthyl
130	p-biphenyl	H	H	H	H	2-naphthyl	2-naphthyl
131	p-biphenyl	H	H	H	H	o-biphenyl	H
132	p-biphenyl	H	H	H	H	H	o-biphenyl
133	p-biphenyl	H	H	H	H	o-biphenyl	o-biphenyl
134	p-biphenyl	H	H	H	H	m-biphenyl	H
135	p-biphenyl	H	H	H	H	H	m-biphenyl
136	p-biphenyl	H	H	H	H	m-biphenyl	m-biphenyl
137	p-biphenyl	H	H	H	H	p-biphenyl	H
138	p-biphenyl	H	H	H	H	H	p-biphenyl
139	p-biphenyl	H	H	H	H	p-biphenyl	p-biphenyl

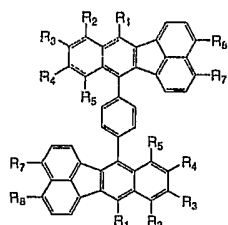

TypeBBB

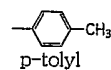
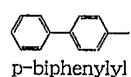
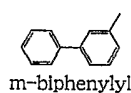
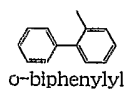
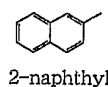
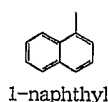

	R ₁	R ₂	R ₃	R ₄	R ₅	R ₇	R ₈
140	o-tolyl	H	H	H	H	H	H
141	o-tolyl	Ph	H	H	Ph	H	H
142	o-tolyl	H	Ph	Ph	H	H	H
143	o-tolyl	H	H	H	H	Ph	H
144	o-tolyl	H	H	H	H	H	Ph
145	o-tolyl	H	H	H	H	1-naphthyl	H
146	o-tolyl	H	H	H	H	H	1-naphthyl
147	o-tolyl	H	H	H	H	2-naphthyl	H
148	o-tolyl	H	H	H	H	H	2-naphthyl
149	o-tolyl	H	H	H	H	o-biphenyl	H
150	o-tolyl	H	H	H	H	H	o-biphenyl
151	o-tolyl	H	H	H	H	m-biphenyl	H
152	o-tolyl	H	H	H	H	H	m-biphenyl
153	o-tolyl	H	H	H	H	p-biphenyl	H
154	o-tolyl	H	H	H	H	H	p-biphenyl
155	o-tolyl	H	H	H	H	o-tolyl	H
156	o-tolyl	H	H	H	H	H	o-tolyl
157	m-tolyl	H	H	H	H	H	H
158	m-tolyl	Ph	H	H	Ph	H	H
159	m-tolyl	H	Ph	Ph	H	H	H
160	m-tolyl	H	H	H	H	Ph	H
161	m-tolyl	H	H	H	H	H	Ph
162	m-tolyl	H	H	H	H	1-naphthyl	H
163	m-tolyl	H	H	H	H	H	1-naphthyl
164	m-tolyl	H	H	H	H	2-naphthyl	H
165	m-tolyl	H	H	H	H	H	2-naphthyl
166	m-tolyl	H	H	H	H	o-biphenyl	H
167	m-tolyl	H	H	H	H	H	o-biphenyl
168	m-tolyl	H	H	H	H	m-biphenyl	H
169	m-tolyl	H	H	H	H	H	m-biphenyl
170	m-tolyl	H	H	H	H	p-biphenyl	H
171	m-tolyl	H	H	H	H	H	p-biphenyl
172	m-tolyl	H	H	H	H	m-tolyl	H
173	m-tolyl	H	H	H	H	H	m-tolyl
174	p-tolyl	H	H	H	H	H	H
175	p-tolyl	Ph	H	H	Ph	H	H
176	p-tolyl	H	Ph	Ph	H	H	H
177	p-tolyl	H	H	H	H	Ph	H
178	p-tolyl	H	H	H	H	H	Ph
179	p-tolyl	H	H	H	H	1-naphthyl	H
180	p-tolyl	H	H	H	H	H	1-naphthyl
181	p-tolyl	H	H	H	H	2-naphthyl	H
182	p-tolyl	H	H	H	H	H	2-naphthyl
183	p-tolyl	H	H	H	H	o-biphenyl	H
184	p-tolyl	H	H	H	H	H	o-biphenyl
185	p-tolyl	H	H	H	H	m-biphenyl	H
186	p-tolyl	H	H	H	H	H	m-biphenyl
187	p-tolyl	H	H	H	H	p-biphenyl	H
188	p-tolyl	H	H	H	H	H	p-biphenyl
189	p-tolyl	H	H	H	H	p-tolyl	H
190	p-tolyl	H	H	H	H	H	p-tolyl

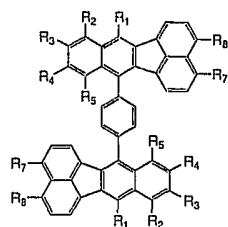

TypeBBB

	R ₁	R ₂	R ₃	R ₄	R ₅	R ₇	R ₈
	191	Ph	H	-CH3	-CH3	H	H
	192	1-naphthyl	H	-CH3	-CH3	H	H
	193	2-naphthyl	H	-CH3	-CH3	H	H
	194	o-biphenyl	H	-CH3	-CH3	H	H
	195	m-biphenyl	H	-CH3	-CH3	H	H
	196	p-biphenyl	H	-CH3	-CH3	H	H
	197	o-tolyl	H	-CH3	-CH3	H	H
	198	m-tolyl	H	-CH3	-CH3	H	H
	199	p-tolyl	H	-CH3	-CH3	H	H
	200	Ph	H	H	H	-CH3	H
	201	1-naphthyl	H	H	H	-CH3	H
	202	2-naphthyl	H	H	H	-CH3	H
	203	o-biphenyl	H	H	H	-CH3	H
	204	m-biphenyl	H	H	H	-CH3	H
	205	p-biphenyl	H	H	H	-CH3	H
	206	o-tolyl	H	H	H	-CH3	H
	207	m-tolyl	H	H	H	-CH3	H
	208	p-tolyl	H	H	H	-CH3	H
	209	Ph	H	H	H	H	-CH3
	210	1-naphthyl	H	H	H	H	-CH3
	211	2-naphthyl	H	H	H	H	-CH3
	212	o-biphenyl	H	H	H	H	-CH3
	213	m-biphenyl	H	H	H	H	-CH3
	214	p-biphenyl	H	H	H	H	-CH3
	215	o-tolyl	H	H	H	H	-CH3
	216	m-tolyl	H	H	H	H	-CH3
	217	p-tolyl	H	H	H	H	-CH3
	218	Ph	H	H	H	-CH3	-CH3
	219	1-naphthyl	H	H	H	-CH3	-CH3
	220	2-naphthyl	H	H	H	-CH3	-CH3
	221	o-biphenyl	H	H	H	-CH3	-CH3
	222	m-biphenyl	H	H	H	-CH3	-CH3
	223	p-biphenyl	H	H	H	-CH3	-CH3
	224	o-tolyl	H	H	H	-CH3	-CH3
	225	m-tolyl	H	H	H	-CH3	-CH3
	226	p-tolyl	H	H	H	-CH3	-CH3
	227	Ph	H	H	H	H	DPA
	228	1-naphthyl	H	H	H	H	DPA
	229	2-naphthyl	H	H	H	H	DPA
	230	o-biphenyl	H	H	H	H	DPA
	231	m-biphenyl	H	H	H	H	DPA
	232	p-biphenyl	H	H	H	H	DPA
	233	Ph	H	H	H	DPA	H
	234	1-naphthyl	H	H	H	DPA	H
	235	2-naphthyl	H	H	H	DPA	H
	236	o-biphenyl	H	H	H	DPA	H
	237	m-biphenyl	H	H	H	DPA	H
	238	p-biphenyl	H	H	H	DPA	H
	239	Ph	H	H	H	H	TPA
	240	1-naphthyl	H	H	H	H	TPA
	241	2-naphthyl	H	H	H	H	TPA
	242	o-biphenyl	H	H	H	H	TPA
	243	m-biphenyl	H	H	H	H	TPA
	244	p-biphenyl	H	H	H	H	TPA
	245	Ph	H	H	H	TPA	H
	246	1-naphthyl	H	H	H	TPA	H
	247	2-naphthyl	H	H	H	TPA	H
	248	o-biphenyl	H	H	H	TPA	H
	249	m-biphenyl	H	H	H	TPA	H
	250	p-biphenyl	H	H	H	TPA	H

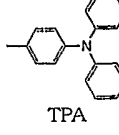
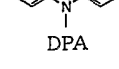
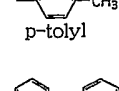
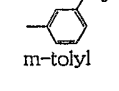
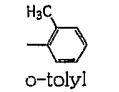
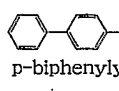
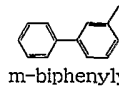
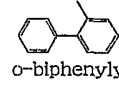
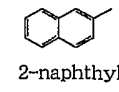
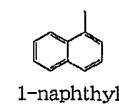

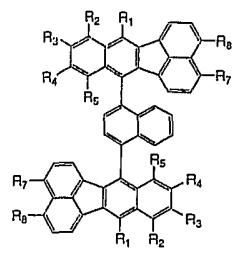

TypeCCC

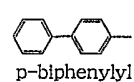
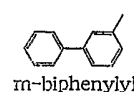
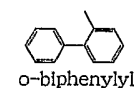
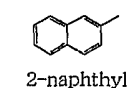
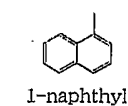

	R ₁	R ₂	R ₃	R ₄	R ₅	R ₇	R ₈
1	H	H	H	H	H	H	H
2	Ph	H	H	H	H	H	H
3	Ph	Ph	H	H	Ph	H	H
4	Ph	H	Ph	Ph	H	H	H
5	Ph	H	Ph	H	H	H	H
6	Ph	H	H	Ph	H	H	H
7	Ph	H	H	H	H	Ph	H
8	Ph	H	H	H	H	H	Ph
9	Ph	H	H	H	H	Ph	Ph
10	Ph	H	H	H	H	1-naphthyl	H
11	Ph	H	H	H	H	H	1-naphthyl
12	Ph	H	H	H	H	1-naphthyl	1-naphthyl
13	Ph	H	H	H	H	2-naphthyl	H
14	Ph	H	H	H	H	H	2-naphthyl
15	Ph	H	H	H	H	2-naphthyl	2-naphthyl
16	Ph	H	H	H	H	o-biphenyl	H
17	Ph	H	H	H	H	H	o-biphenyl
18	Ph	H	H	H	H	o-biphenyl	o-biphenyl
19	Ph	H	H	H	H	m-biphenyl	H
20	Ph	H	H	H	H	H	m-biphenyl
21	Ph	H	H	H	H	m-biphenyl	m-biphenyl
22	Ph	H	H	H	H	p-biphenyl	H
23	Ph	H	H	H	H	H	p-biphenyl
24	Ph	H	H	H	H	p-biphenyl	p-biphenyl
25	1-naphthyl	H	H	H	H	H	H
26	1-naphthyl	Ph	H	H	Ph	H	H
27	1-naphthyl	H	Ph	Ph	H	H	H
28	1-naphthyl	H	Ph	H	H	H	H
29	1-naphthyl	H	H	Ph	H	H	H
30	1-naphthyl	H	H	H	H	Ph	H
31	1-naphthyl	H	H	H	H	H	Ph
32	1-naphthyl	H	H	H	H	Ph	Ph
33	1-naphthyl	H	H	H	H	1-naphthyl	H
34	1-naphthyl	H	H	H	H	H	1-naphthyl
35	1-naphthyl	H	H	H	H	1-naphthyl	1-naphthyl
36	1-naphthyl	H	H	H	H	2-naphthyl	H
37	1-naphthyl	H	H	H	H	H	2-naphthyl
38	1-naphthyl	H	H	H	H	2-naphthyl	2-naphthyl
39	1-naphthyl	H	H	H	H	o-biphenyl	H
40	1-naphthyl	H	H	H	H	H	o-biphenyl
41	1-naphthyl	H	H	H	H	o-biphenyl	o-biphenyl
42	1-naphthyl	H	H	H	H	m-biphenyl	H
43	1-naphthyl	H	H	H	H	H	m-biphenyl
44	1-naphthyl	H	H	H	H	m-biphenyl	m-biphenyl
45	1-naphthyl	H	H	H	H	p-biphenyl	H
46	1-naphthyl	H	H	H	H	H	p-biphenyl
47	1-naphthyl	H	H	H	H	p-biphenyl	p-biphenyl

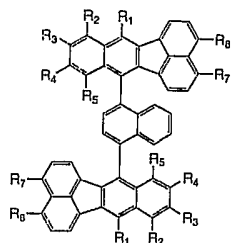

TypeCCC

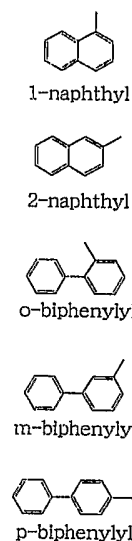

	R ₁	R ₂	R ₃	R ₄	R ₅	R ₇	R ₈
48	2-naphthyl	H	H	H	H	H	H
49	2-naphthyl	Ph	H	H	Ph	H	H
50	2-naphthyl	H	Ph	Ph	H	H	H
51	2-naphthyl	H	Ph	H	H	H	H
52	2-naphthyl	H	H	Ph	H	H	H
53	2-naphthyl	H	H	H	H	Ph	H
54	2-naphthyl	H	H	H	H	H	Ph
55	2-naphthyl	H	H	H	H	Ph	Ph
56	2-naphthyl	H	H	H	H	1-naphthyl	H
57	2-naphthyl	H	H	H	H	H	1-naphthyl
58	2-naphthyl	H	H	H	H	1-naphthyl	1-naphthyl
59	2-naphthyl	H	H	H	H	2-naphthyl	H
60	2-naphthyl	H	H	H	H	H	2-naphthyl
61	2-naphthyl	H	H	H	H	2-naphthyl	2-naphthyl
62	2-naphthyl	H	H	H	H	o-biphenyl	H
63	2-naphthyl	H	H	H	H	H	o-biphenyl
64	2-naphthyl	H	H	H	H	o-biphenyl	o-biphenyl
65	2-naphthyl	H	H	H	H	m-biphenyl	H
66	2-naphthyl	H	H	H	H	H	m-biphenyl
67	2-naphthyl	H	H	H	H	m-biphenyl	m-biphenyl
68	2-naphthyl	H	H	H	H	p-biphenyl	H
69	2-naphthyl	H	H	H	H	H	p-biphenyl
70	2-naphthyl	H	H	H	H	p-biphenyl	p-biphenyl
71	o-biphenyl	H	H	H	H	H	H
72	o-biphenyl	Ph	H	H	Ph	H	H
73	o-biphenyl	H	Ph	Ph	H	H	H
74	o-biphenyl	H	Ph	H	H	H	H
75	o-biphenyl	H	H	Ph	H	H	H
76	o-biphenyl	H	H	H	H	Ph	H
77	o-biphenyl	H	H	H	H	H	Ph
78	o-biphenyl	H	H	H	H	Ph	Ph
79	o-biphenyl	H	H	H	H	1-naphthyl	H
80	o-biphenyl	H	H	H	H	H	1-naphthyl
81	o-biphenyl	H	H	H	H	1-naphthyl	1-naphthyl
82	o-biphenyl	H	H	H	H	2-naphthyl	H
83	o-biphenyl	H	H	H	H	H	2-naphthyl
84	o-biphenyl	H	H	H	H	2-naphthyl	2-naphthyl
85	o-biphenyl	H	H	H	H	o-biphenyl	H
86	o-biphenyl	H	H	H	H	H	o-biphenyl
87	o-biphenyl	H	H	H	H	o-biphenyl	o-biphenyl
88	o-biphenyl	H	H	H	H	m-biphenyl	H
89	o-biphenyl	H	H	H	H	H	m-biphenyl
90	o-biphenyl	H	H	H	H	m-biphenyl	m-biphenyl
91	o-biphenyl	H	H	H	H	p-biphenyl	H
92	o-biphenyl	H	H	H	H	H	p-biphenyl
93	o-biphenyl	H	H	H	H	p-biphenyl	p-biphenyl

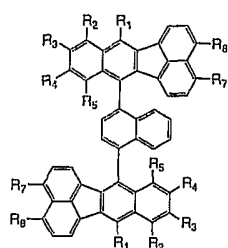

TypeCCC



1-naphthyl



2-naphthyl

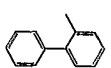

o-biphenyl

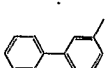

m-biphenyl

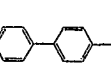

p-biphenyl

	R ₁	R ₂	R ₃	R ₄	R ₅	R ₇	R ₈
94	m-biphenyl	H	H	H	H	H	H
95	m-biphenyl	Ph	H	H	Ph	H	H
96	m-biphenyl	H	Ph	Ph	H	H	H
97	m-biphenyl	H	Ph	H	H	H	H
98	m-biphenyl	H	H	Ph	H	H	H
99	m-biphenyl	H	H	H	H	Ph	H
100	m-biphenyl	H	H	H	H	H	Ph
101	m-biphenyl	H	H	H	H	Ph	Ph
102	m-biphenyl	H	H	H	H	1-naphthyl	H
103	m-biphenyl	H	H	H	H	H	1-naphthyl
104	m-biphenyl	H	H	H	H	1-naphthyl	1-naphthyl
105	m-biphenyl	H	H	H	H	2-naphthyl	H
106	m-biphenyl	H	H	H	H	H	2-naphthyl
107	m-biphenyl	H	H	H	H	2-naphthyl	2-naphthyl
108	m-biphenyl	H	H	H	H	o-biphenyl	H
109	m-biphenyl	H	H	H	H	H	o-biphenyl
110	m-biphenyl	H	H	H	H	o-biphenyl	o-biphenyl
111	m-biphenyl	H	H	H	H	m-biphenyl	H
112	m-biphenyl	H	H	H	H	H	m-biphenyl
113	m-biphenyl	H	H	H	H	m-biphenyl	m-biphenyl
114	m-biphenyl	H	H	H	H	p-biphenyl	H
115	m-biphenyl	H	H	H	H	H	p-biphenyl
116	m-biphenyl	H	H	H	H	p-biphenyl	p-biphenyl
117	p-biphenyl	H	H	H	H	H	H
118	p-biphenyl	Ph	H	H	Ph	H	H
119	p-biphenyl	H	Ph	Ph	H	H	H
120	p-biphenyl	H	Ph	H	H	H	H
121	p-biphenyl	H	H	Ph	H	H	H
122	p-biphenyl	H	H	H	H	Ph	H
123	p-biphenyl	H	H	H	H	H	Ph
124	p-biphenyl	H	H	H	H	Ph	Ph
125	p-biphenyl	H	H	H	H	1-naphthyl	H
126	p-biphenyl	H	H	H	H	H	1-naphthyl
127	p-biphenyl	H	H	H	H	1-naphthyl	1-naphthyl
128	p-biphenyl	H	H	H	H	2-naphthyl	H
129	p-biphenyl	H	H	H	H	H	2-naphthyl
130	p-biphenyl	H	H	H	H	2-naphthyl	2-naphthyl
131	p-biphenyl	H	H	H	H	o-biphenyl	H
132	p-biphenyl	H	H	H	H	H	o-biphenyl
133	p-biphenyl	H	H	H	H	o-biphenyl	o-biphenyl
134	p-biphenyl	H	H	H	H	m-biphenyl	H
135	p-biphenyl	H	H	H	H	H	m-biphenyl
136	p-biphenyl	H	H	H	H	m-biphenyl	m-biphenyl
137	p-biphenyl	H	H	H	H	p-biphenyl	H
138	p-biphenyl	H	H	H	H	H	p-biphenyl
139	p-biphenyl	H	H	H	H	p-biphenyl	p-biphenyl

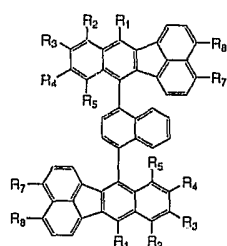

Type CCC

	R ₁	R ₂	R ₃	R ₄	R ₅	R ₇	R ₈
140	o-tolyl	H	H	H	H	H	H
141	o-tolyl	Ph	H	H	Ph	H	H
142	o-tolyl	H	Ph	Ph	H	H	H
143	o-tolyl	H	H	H	H	Ph	H
144	o-tolyl	H	H	H	H	H	Ph
145	o-tolyl	H	H	H	H	1-naphthyl	H
146	o-tolyl	H	H	H	H	H	1-naphthyl
147	o-tolyl	H	H	H	H	2-naphthyl	H
148	o-tolyl	H	H	H	H	H	2-naphthyl
149	o-tolyl	H	H	H	H	o-biphenyl	H
150	o-tolyl	H	H	H	H	H	o-biphenyl
151	o-tolyl	H	H	H	H	m-biphenyl	H
152	o-tolyl	H	H	H	H	H	m-biphenyl
153	o-tolyl	H	H	H	H	p-biphenyl	H
154	o-tolyl	H	H	H	H	H	p-biphenyl
155	o-tolyl	H	H	H	H	o-tolyl	H
156	o-tolyl	H	H	H	H	H	o-tolyl
157	m-tolyl	H	H	H	H	H	H
158	m-tolyl	Ph	H	H	Ph	H	H
159	m-tolyl	H	Ph	Ph	H	H	H
160	m-tolyl	H	H	H	H	Ph	H
161	m-tolyl	H	H	H	H	H	Ph
162	m-tolyl	H	H	H	H	1-naphthyl	H
163	m-tolyl	H	H	H	H	H	1-naphthyl
164	m-tolyl	H	H	H	H	2-naphthyl	H
165	m-tolyl	H	H	H	H	H	2-naphthyl
166	m-tolyl	H	H	H	H	o-biphenyl	H
167	m-tolyl	H	H	H	H	H	o-biphenyl
168	m-tolyl	H	H	H	H	m-biphenyl	H
169	m-tolyl	H	H	H	H	H	m-biphenyl
170	m-tolyl	H	H	H	H	p-biphenyl	H
171	m-tolyl	H	H	H	H	H	p-biphenyl
172	m-tolyl	H	H	H	H	m-tolyl	H
173	m-tolyl	H	H	H	H	H	m-tolyl
174	p-tolyl	H	H	H	H	H	H
175	p-tolyl	Ph	H	H	Ph	H	H
176	p-tolyl	H	Ph	Ph	H	H	H
177	p-tolyl	H	H	H	H	Ph	H
178	p-tolyl	H	H	H	H	H	Ph
179	p-tolyl	H	H	H	H	1-naphthyl	H
180	p-tolyl	H	H	H	H	H	1-naphthyl
181	p-tolyl	H	H	H	H	2-naphthyl	H
182	p-tolyl	H	H	H	H	H	2-naphthyl
183	p-tolyl	H	H	H	H	o-biphenyl	H
184	p-tolyl	H	H	H	H	H	o-biphenyl
185	p-tolyl	H	H	H	H	m-biphenyl	H
186	p-tolyl	H	H	H	H	H	m-biphenyl
187	p-tolyl	H	H	H	H	p-biphenyl	H
188	p-tolyl	H	H	H	H	H	p-biphenyl
189	p-tolyl	H	H	H	H	p-tolyl	H
190	p-tolyl	H	H	H	H	H	p-tolyl

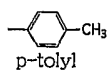
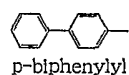
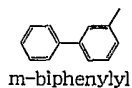
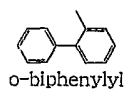
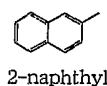
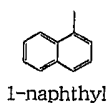

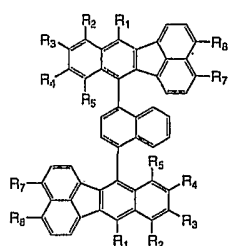

TypeCCC

	R ₁	R ₂	R ₃	R ₄	R ₅	R ₇	R ₈
	Ph	H	-CH ₃	-CH ₃	H	H	H
	1-naphtyl	H	-CH ₃	-CH ₃	H	H	H
	2-naphtyl	H	-CH ₃	-CH ₃	H	H	H
	o-biphenyl	H	-CH ₃	-CH ₃	H	H	H
	m-biphenyl	H	-CH ₃	-CH ₃	H	H	H
	p-biphenyl	H	-CH ₃	-CH ₃	H	H	H
	o-tolyl	H	-CH ₃	-CH ₃	H	H	H
	m-tolyl	H	-CH ₃	-CH ₃	H	H	H
	p-tolyl	H	-CH ₃	-CH ₃	H	H	H
	Ph	H	H	H	H	-CH ₃	H
	1-naphtyl	H	H	H	H	-CH ₃	H
	2-naphtyl	H	H	H	H	-CH ₃	H
	o-biphenyl	H	H	H	H	-CH ₃	H
	m-biphenyl	H	H	H	H	-CH ₃	H
	p-biphenyl	H	H	H	H	-CH ₃	H
	o-tolyl	H	H	H	H	-CH ₃	H
	m-tolyl	H	H	H	H	-CH ₃	H
	p-tolyl	H	H	H	H	-CH ₃	H
	Ph	H	H	H	H	H	-CH ₃
	1-naphtyl	H	H	H	H	H	-CH ₃
	2-naphtyl	H	H	H	H	H	-CH ₃
	o-biphenyl	H	H	H	H	H	-CH ₃
	m-biphenyl	H	H	H	H	H	-CH ₃
	p-biphenyl	H	H	H	H	H	-CH ₃
	o-tolyl	H	H	H	H	H	-CH ₃
	m-tolyl	H	H	H	H	H	-CH ₃
	p-tolyl	H	H	H	H	H	-CH ₃
	Ph	H	H	H	H	-CH ₃	-CH ₃
	1-naphtyl	H	H	H	H	-CH ₃	-CH ₃
	2-naphtyl	H	H	H	H	-CH ₃	-CH ₃
	o-biphenyl	H	H	H	H	-CH ₃	-CH ₃
	m-biphenyl	H	H	H	H	-CH ₃	-CH ₃
	p-biphenyl	H	H	H	H	-CH ₃	-CH ₃
	o-tolyl	H	H	H	H	-CH ₃	-CH ₃
	m-tolyl	H	H	H	H	-CH ₃	-CH ₃
	p-tolyl	H	H	H	H	-CH ₃	-CH ₃
	Ph	H	H	H	H	H	DPA
	1-naphtyl	H	H	H	H	H	DPA
	2-naphtyl	H	H	H	H	H	DPA
	o-biphenyl	H	H	H	H	H	DPA
	m-biphenyl	H	H	H	H	H	DPA
	p-biphenyl	H	H	H	H	H	DPA
	o-tolyl	H	H	H	H	H	DPA
	m-tolyl	H	H	H	H	H	DPA
	p-tolyl	H	H	H	H	H	DPA
	Ph	H	H	H	H	DPA	H
	1-naphtyl	H	H	H	H	DPA	H
	2-naphtyl	H	H	H	H	DPA	H
	o-biphenyl	H	H	H	H	DPA	H
	m-biphenyl	H	H	H	H	DPA	H
	p-biphenyl	H	H	H	H	DPA	H
	Ph	H	H	H	H	H	TPA
	1-naphtyl	H	H	H	H	H	TPA
	2-naphtyl	H	H	H	H	H	TPA
	o-biphenyl	H	H	H	H	H	TPA
	m-biphenyl	H	H	H	H	H	TPA
	p-biphenyl	H	H	H	H	H	TPA
	Ph	H	H	H	H	TPA	H
	1-naphtyl	H	H	H	H	TPA	H
	2-naphtyl	H	H	H	H	TPA	H
	o-biphenyl	H	H	H	H	TPA	H
	m-biphenyl	H	H	H	H	TPA	H
	p-biphenyl	H	H	H	H	TPA	H

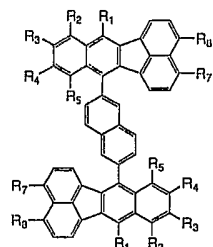

TypeDDD

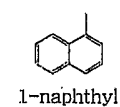

1-naphthyl

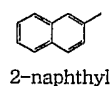

2-naphthyl

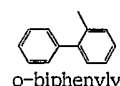

o-biphenyl

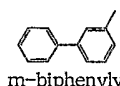

m-biphenyl

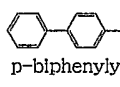

p-biphenyl

	R ₁	R ₂	R ₃	R ₄	R ₅	R ₇	R ₈
1	H	H	H	H	H	H	H
2	Ph	H	H	H	H	H	H
3	Ph	Ph	H	H	Ph	H	H
4	Ph	H	Ph	Ph	H	H	H
5	Ph	H	Ph	H	H	H	H
6	Ph	H	H	Ph	H	H	H
7	Ph	H	H	H	H	Ph	H
8	Ph	H	H	H	H	H	Ph
9	Ph	H	H	H	H	Ph	Ph
10	Ph	H	H	H	H	1-naphthyl	H
11	Ph	H	H	H	H	H	1-naphthyl
12	Ph	H	H	H	H	1-naphthyl	1-naphthyl
13	Ph	H	H	H	H	2-naphthyl	H
14	Ph	H	H	H	H	H	2-naphthyl
15	Ph	H	H	H	H	2-naphthyl	2-naphthyl
16	Ph	H	H	H	H	o-biphenyl	H
17	Ph	H	H	H	H	H	o-biphenyl
18	Ph	H	H	H	H	o-biphenyl	o-biphenyl
19	Ph	H	H	H	H	m-biphenyl	H
20	Ph	H	H	H	H	H	m-biphenyl
21	Ph	H	H	H	H	m-biphenyl	m-biphenyl
22	Ph	H	H	H	H	p-biphenyl	H
23	Ph	H	H	H	H	H	p-biphenyl
24	Ph	H	H	H	H	p-biphenyl	p-biphenyl
25	1-naphthyl	H	H	H	H	H	H
26	1-naphthyl	Ph	H	H	Ph	H	H
27	1-naphthyl	H	Ph	Ph	H	H	H
28	1-naphthyl	H	Ph	H	H	H	H
29	1-naphthyl	H	H	Ph	H	H	H
30	1-naphthyl	H	H	H	H	Ph	H
31	1-naphthyl	H	H	H	H	H	Ph
32	1-naphthyl	H	H	H	H	Ph	Ph
33	1-naphthyl	H	H	H	H	1-naphthyl	H
34	1-naphthyl	H	H	H	H	H	1-naphthyl
35	1-naphthyl	H	H	H	H	1-naphthyl	1-naphthyl
36	1-naphthyl	H	H	H	H	2-naphthyl	H
37	1-naphthyl	H	H	H	H	H	2-naphthyl
38	1-naphthyl	H	H	H	H	2-naphthyl	2-naphthyl
39	1-naphthyl	H	H	H	H	o-biphenyl	H
40	1-naphthyl	H	H	H	H	H	o-biphenyl
41	1-naphthyl	H	H	H	H	o-biphenyl	o-biphenyl
42	1-naphthyl	H	H	H	H	m-biphenyl	H
43	1-naphthyl	H	H	H	H	H	m-biphenyl
44	1-naphthyl	H	H	H	H	m-biphenyl	m-biphenyl
45	1-naphthyl	H	H	H	H	p-biphenyl	H
46	1-naphthyl	H	H	H	H	H	p-biphenyl
47	1-naphthyl	H	H	H	H	p-biphenyl	p-biphenyl

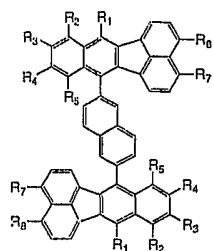

TypeDDD

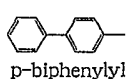
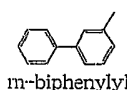
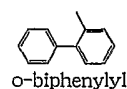
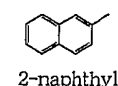
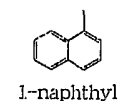

	R ₁	R ₂	R ₃	R ₄	R ₅	R ₇	R ₈
48	2-naphthyl	H	H	H	H	H	H
49	2-naphthyl	Ph	H	H	Ph	H	H
50	2-naphthyl	H	Ph	Ph	H	H	H
51	2-naphthyl	H	Ph	H	H	H	H
52	2-naphthyl	H	H	Ph	H	H	H
53	2-naphthyl	H	H	H	H	Ph	H
54	2-naphthyl	H	H	H	H	H	Ph
55	2-naphthyl	H	H	H	H	Ph	Ph
56	2-naphthyl	H	H	H	H	1-naphthyl	H
57	2-naphthyl	H	H	H	H	H	1-naphthyl
58	2-naphthyl	H	H	H	H	1-naphthyl	1-naphthyl
59	2-naphthyl	H	H	H	H	2-naphthyl	H
60	2-naphthyl	H	H	H	H	H	2-naphthyl
61	2-naphthyl	H	H	H	H	2-naphthyl	2-naphthyl
62	2-naphthyl	H	H	H	H	o-biphenyl	H
63	2-naphthyl	H	H	H	H	H	o-biphenyl
64	2-naphthyl	H	H	H	H	o-biphenyl	o-biphenyl
65	2-naphthyl	H	H	H	H	m-biphenyl	H
66	2-naphthyl	H	H	H	H	H	m-biphenyl
67	2-naphthyl	H	H	H	H	m-biphenyl	m-biphenyl
68	2-naphthyl	H	H	H	H	p-biphenyl	H
69	2-naphthyl	H	H	H	H	H	p-biphenyl
70	2-naphthyl	H	H	H	H	p-biphenyl	p-biphenyl
71	o-biphenyl	H	H	H	H	H	H
72	o-biphenyl	Ph	H	H	Ph	H	H
73	o-biphenyl	H	Ph	Ph	H	H	H
74	o-biphenyl	H	Ph	H	H	H	H
75	o-biphenyl	H	H	Ph	H	H	H
76	o-biphenyl	H	H	H	H	Ph	H
77	o-biphenyl	H	H	H	H	H	Ph
78	o-biphenyl	H	H	H	H	Ph	Ph
79	o-biphenyl	H	H	H	H	1-naphthyl	H
80	o-biphenyl	H	H	H	H	H	1-naphthyl
81	o-biphenyl	H	H	H	H	1-naphthyl	1-naphthyl
82	o-biphenyl	H	H	H	H	2-naphthyl	H
83	o-biphenyl	H	H	H	H	H	2-naphthyl
84	o-biphenyl	H	H	H	H	2-naphthyl	2-naphthyl
85	o-biphenyl	H	H	H	H	o-biphenyl	H
86	o-biphenyl	H	H	H	H	H	o-biphenyl
87	o-biphenyl	H	H	H	H	o-biphenyl	o-biphenyl
88	o-biphenyl	H	H	H	H	m-biphenyl	H
89	o-biphenyl	H	H	H	H	H	m-biphenyl
90	o-biphenyl	H	H	H	H	m-biphenyl	m-biphenyl
91	o-biphenyl	H	H	H	H	p-biphenyl	H
92	o-biphenyl	H	H	H	H	H	p-biphenyl
93	o-biphenyl	H	H	H	H	p-biphenyl	p-biphenyl

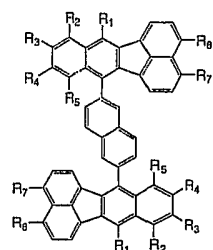

TypeDDD



1-naphthyl



2-naphthyl



o-biphenylyl





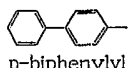



m-biphenylyl

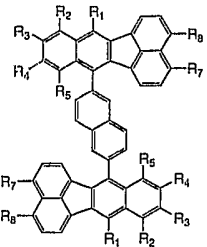

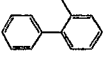
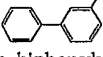
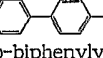
p-biphenylyl

	R ₁	R ₂	R ₃	R ₄	R ₅	R ₇	R ₈
94	m-biphenylyl	H	H	H	H	H	H
95	m-biphenylyl	Ph	H	H	Ph	H	H
96	m-biphenylyl	H	Ph	Ph	H	H	H
97	m-biphenylyl	H	Ph	H	H	H	H
98	m-biphenylyl	H	H	Ph	H	H	H
99	m-biphenylyl	H	H	H	H	Ph	H
100	m-biphenylyl	H	H	H	H	H	Ph
101	m-biphenylyl	H	H	H	H	Ph	Ph
102	m-biphenylyl	H	H	H	H	1-naphthyl	H
103	m-biphenylyl	H	H	H	H	H	1-naphthyl
104	m-biphenylyl	H	H	H	H	1-naphthyl	1-naphthyl
105	m-biphenylyl	H	H	H	H	2-naphthyl	H
106	m-biphenylyl	H	H	H	H	H	2-naphthyl
107	m-biphenylyl	H	H	H	H	2-naphthyl	2-naphthyl
108	m-biphenylyl	H	H	H	H	o-biphenylyl	H
109	m-biphenylyl	H	H	H	H	H	o-biphenylyl
110	m-biphenylyl	H	H	H	H	o-biphenylyl	o-biphenylyl
111	m-biphenylyl	H	H	H	H	m-biphenylyl	H
112	m-biphenylyl	H	H	H	H	H	m-biphenylyl
113	m-biphenylyl	H	H	H	H	m-biphenylyl	m-biphenylyl
114	m-biphenylyl	H	H	H	H	p-biphenylyl	H
115	m-biphenylyl	H	H	H	H	H	p-biphenylyl
116	m-biphenylyl	H	H	H	H	p-biphenylyl	p-biphenylyl
117	p-biphenylyl	H	H	H	H	H	H
118	p-biphenylyl	Ph	H	H	Ph	H	H
119	p-biphenylyl	H	Ph	Ph	H	H	H
120	p-biphenylyl	H	Ph	H	H	H	H
121	p-biphenylyl	H	H	Ph	H	H	H
122	p-biphenylyl	H	H	H	H	Ph	H
123	p-biphenylyl	H	H	H	H	H	Ph
124	p-biphenylyl	H	H	H	H	Ph	Ph
125	p-biphenylyl	H	H	H	H	1-naphthyl	H
126	p-biphenylyl	H	H	H	H	H	1-naphthyl
127	p-biphenylyl	H	H	H	H	1-naphthyl	1-naphthyl
128	p-biphenylyl	H	H	H	H	2-naphthyl	H
129	p-biphenylyl	H	H	H	H	H	2-naphthyl
130	p-biphenylyl	H	H	H	H	2-naphthyl	2-naphthyl
131	p-biphenylyl	H	H	H	H	o-biphenylyl	H
132	p-biphenylyl	H	H	H	H	H	o-biphenylyl
133	p-biphenylyl	H	H	H	H	o-biphenylyl	o-biphenylyl
134	p-biphenylyl	H	H	H	H	m-biphenylyl	H
135	p-biphenylyl	H	H	H	H	H	m-biphenylyl
136	p-biphenylyl	H	H	H	H	m-biphenylyl	m-biphenylyl
137	p-biphenylyl	H	H	H	H	p-biphenylyl	H
138	p-biphenylyl	H	H	H	H	H	p-biphenylyl
139	p-biphenylyl	H	H	H	H	p-biphenylyl	p-biphenylyl

	R ₁	R ₂	R ₃	R ₄	R ₅	R ₇	R ₈
	140	o-tolyl	H	H	H	H	H
	141	o-tolyl	Ph	H	H	Ph	H
	142	o-tolyl	H	Ph	Ph	H	H
	143	o-tolyl	H	H	H	Ph	H
	144	o-tolyl	H	H	H	H	Ph
	145	o-tolyl	H	H	H	1-naphthyl	H
	146	o-tolyl	H	H	H	H	1-naphthyl
	147	o-tolyl	H	H	H	2-naphthyl	H
	148	o-tolyl	H	H	H	H	2-naphthyl
	149	o-tolyl	H	H	H	o-biphenyl	H
	150	o-tolyl	H	H	H	H	o-biphenyl
	151	o-tolyl	H	H	H	m-biphenyl	H
	152	o-tolyl	H	H	H	H	m-biphenyl
	153	o-tolyl	H	H	H	p-biphenyl	H
	154	o-tolyl	H	H	H	H	p-biphenyl
	155	o-tolyl	H	H	H	o-tolyl	H
	156	o-tolyl	H	H	H	H	o-tolyl
1-naphthyl	157	m-tolyl	H	H	H	H	H
	158	m-tolyl	Ph	H	H	Ph	H
	159	m-tolyl	H	Ph	Ph	H	H
2-naphthyl	160	m-tolyl	H	H	H	Ph	H
	161	m-tolyl	H	H	H	H	Ph
	162	m-tolyl	H	H	H	1-naphthyl	H
	163	m-tolyl	H	H	H	H	1-naphthyl
o-biphenyl	164	m-tolyl	H	H	H	2-naphthyl	H
	165	m-tolyl	H	H	H	H	2-naphthyl
	166	m-tolyl	H	H	H	o-biphenyl	H
	167	m-tolyl	H	H	H	H	o-biphenyl
m-biphenyl	168	m-tolyl	H	H	H	m-biphenyl	H
	169	m-tolyl	H	H	H	H	m-biphenyl
	170	m-tolyl	H	H	H	p-biphenyl	H
p-biphenyl	171	m-tolyl	H	H	H	H	p-biphenyl
	172	m-tolyl	H	H	H	m-tolyl	H
	173	m-tolyl	H	H	H	H	m-tolyl
	174	p-tolyl	H	H	H	H	H
o-tolyl	175	p-tolyl	Ph	H	H	Ph	H
	176	p-tolyl	H	Ph	Ph	H	H
m-tolyl	177	p-tolyl	H	H	H	Ph	H
	178	p-tolyl	H	H	H	H	Ph
	179	p-tolyl	H	H	H	H	1-naphthyl
p-tolyl	180	p-tolyl	H	H	H	H	1-naphthyl
	181	p-tolyl	H	H	H	2-naphthyl	H
	182	p-tolyl	H	H	H	H	2-naphthyl
	183	p-tolyl	H	H	H	o-biphenyl	H
	184	p-tolyl	H	H	H	H	o-biphenyl
	185	p-tolyl	H	H	H	m-biphenyl	H
	186	p-tolyl	H	H	H	H	m-biphenyl
	187	p-tolyl	H	H	H	p-biphenyl	H
	188	p-tolyl	H	H	H	H	p-biphenyl
	189	p-tolyl	H	H	H	p-tolyl	H
	190	p-tolyl	H	H	H	H	p-tolyl

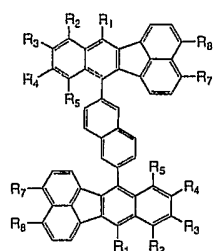

TypeDDD

	R ₁	R ₂	R ₃	R ₄	R ₅	R ₇	R ₈
191	Ph	H	-CH ₃	-CH ₃	H	H	H
192	1-naphthyl	H	-CH ₃	-CH ₃	H	H	H
193	2-naphthyl	H	-CH ₃	-CH ₃	H	H	H
194	o-biphenyl	H	-CH ₃	-CH ₃	H	H	H
195	m-biphenyl	H	-CH ₃	-CH ₃	H	H	H
196	p-biphenyl	H	-CH ₃	-CH ₃	H	H	H
197	o-tolyl	H	-CH ₃	-CH ₃	H	H	H
198	m-tolyl	H	-CH ₃	-CH ₃	H	H	H
199	p-tolyl	H	-CH ₃	-CH ₃	H	H	H
200	Ph	H	H	H	H	-CH ₃	H
201	1-naphthyl	H	H	H	H	-CH ₃	H
202	2-naphthyl	H	H	H	H	-CH ₃	H
203	o-biphenyl	H	H	H	H	-CH ₃	H
204	m-biphenyl	H	H	H	H	-CH ₃	H
205	p-biphenyl	H	H	H	H	-CH ₃	H
206	o-tolyl	H	H	H	H	-CH ₃	H
207	m-tolyl	H	H	H	H	-CH ₃	H
208	p-tolyl	H	H	H	H	-CH ₃	H
209	Ph	H	H	H	H	H	-CH ₃
210	1-naphthyl	H	H	H	H	H	-CH ₃
211	2-naphthyl	H	H	H	H	H	-CH ₃
212	o-biphenyl	H	H	H	H	H	-CH ₃
213	m-biphenyl	H	H	H	H	H	-CH ₃
214	p-biphenyl	H	H	H	H	H	-CH ₃
215	o-tolyl	H	H	H	H	H	-CH ₃
216	m-tolyl	H	H	H	H	H	-CH ₃
217	p-tolyl	H	H	H	H	H	-CH ₃
218	Ph	H	H	H	H	-CH ₃	-CH ₃
219	1-naphthyl	H	H	H	H	-CH ₃	-CH ₃
220	2-naphthyl	H	H	H	H	-CH ₃	-CH ₃
221	o-biphenyl	H	H	H	H	-CH ₃	-CH ₃
222	m-biphenyl	H	H	H	H	-CH ₃	-CH ₃
223	p-biphenyl	H	H	H	H	-CH ₃	-CH ₃
224	o-tolyl	H	H	H	H	-CH ₃	-CH ₃
225	m-tolyl	H	H	H	H	-CH ₃	-CH ₃
226	p-tolyl	H	H	H	H	-CH ₃	-CH ₃
227	Ph	H	H	H	H	H	DPA
228	1-naphthyl	H	H	H	H	H	DPA
229	2-naphthyl	H	H	H	H	H	DPA
230	o-biphenyl	H	H	H	H	H	DPA
231	m-biphenyl	H	H	H	H	H	DPA
232	p-biphenyl	H	H	H	H	H	DPA
233	Ph	H	H	H	H	DPA	H
234	1-naphthyl	H	H	H	H	DPA	H
235	2-naphthyl	H	H	H	H	DPA	H
236	o-biphenyl	H	H	H	H	DPA	H
237	m-biphenyl	H	H	H	H	DPA	H
238	p-biphenyl	H	H	H	H	DPA	H
239	Ph	H	H	H	H	H	TPA
240	1-naphthyl	H	H	H	H	H	TPA
241	2-naphthyl	H	H	H	H	H	TPA
242	o-biphenyl	H	H	H	H	H	TPA
243	m-biphenyl	H	H	H	H	H	TPA
244	p-biphenyl	H	H	H	H	H	TPA
245	Ph	H	H	H	H	TPA	H
246	1-naphthyl	H	H	H	H	TPA	H
247	2-naphthyl	H	H	H	H	TPA	H
248	o-biphenyl	H	H	H	H	TPA	H
249	m-biphenyl	H	H	H	H	TPA	H
250	p-biphenyl	H	H	H	H	TPA	H

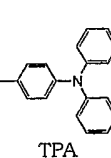
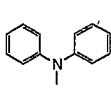
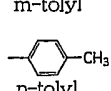
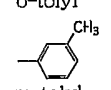
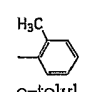
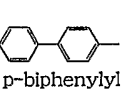
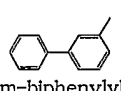
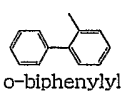
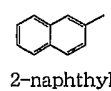
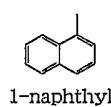

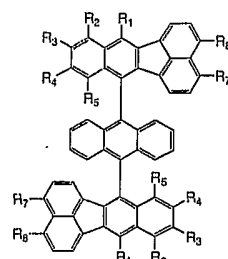

TypeEEE

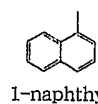

1-naphthyl



2-naphthyl

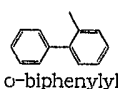

o-biphenyl

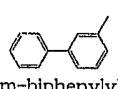

m-biphenyl

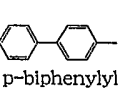

p-biphenyl

	R ₁	R ₂	R ₃	R ₄	R ₅	R ₇	R ₈
1	H	H	H	H	H	H	H
2	Ph	H	H	H	H	H	H
3	Ph	Ph	H	H	Ph	H	H
4	Ph	H	Ph	Ph	H	H	H
5	Ph	H	Ph	H	H	H	H
6	Ph	H	H	Ph	H	H	H
7	Ph	H	H	H	H	Ph	H
8	Ph	H	H	H	H	H	Ph
9	Ph	H	H	H	H	Ph	Ph
10	Ph	H	H	H	H	1-naphthyl	H
11	Ph	H	H	H	H	H	1-naphthyl
12	Ph	H	H	H	H	1-naphthyl	1-naphthyl
13	Ph	H	H	H	H	2-naphthyl	H
14	Ph	H	H	H	H	H	2-naphthyl
15	Ph	H	H	H	H	2-naphthyl	2-naphthyl
16	Ph	H	H	H	H	o-biphenyl	H
17	Ph	H	H	H	H	H	o-biphenyl
18	Ph	H	H	H	H	o-biphenyl	o-biphenyl
19	Ph	H	H	H	H	m-biphenyl	H
20	Ph	H	H	H	H	H	m-biphenyl
21	Ph	H	H	H	H	m-biphenyl	m-biphenyl
22	Ph	H	H	H	H	p-biphenyl	H
23	Ph	H	H	H	H	H	p-biphenyl
24	Ph	H	H	H	H	p-biphenyl	p-biphenyl
25	1-naphthyl	H	H	H	H	H	H
26	1-naphthyl	Ph	H	H	Ph	H	H
27	1-naphthyl	H	Ph	Ph	H	H	H
28	1-naphthyl	H	Ph	H	H	H	H
29	1-naphthyl	H	H	Ph	H	H	H
30	1-naphthyl	H	H	H	H	Ph	H
31	1-naphthyl	H	H	H	H	H	Ph
32	1-naphthyl	H	H	H	H	Ph	Ph
33	1-naphthyl	H	H	H	H	1-naphthyl	H
34	1-naphthyl	H	H	H	H	H	1-naphthyl
35	1-naphthyl	H	H	H	H	1-naphthyl	1-naphthyl
36	1-naphthyl	H	H	H	H	2-naphthyl	H
37	1-naphthyl	H	H	H	H	H	2-naphthyl
38	1-naphthyl	H	H	H	H	2-naphthyl	2-naphthyl
39	1-naphthyl	H	H	H	H	o-biphenyl	H
40	1-naphthyl	H	H	H	H	H	o-biphenyl
41	1-naphthyl	H	H	H	H	o-biphenyl	o-biphenyl
42	1-naphthyl	H	H	H	H	m-biphenyl	H
43	1-naphthyl	H	H	H	H	H	m-biphenyl
44	1-naphthyl	H	H	H	H	m-biphenyl	m-biphenyl
45	1-naphthyl	H	H	H	H	p-biphenyl	H
46	1-naphthyl	H	H	H	H	H	p-biphenyl
47	1-naphthyl	H	H	H	H	p-biphenyl	p-biphenyl

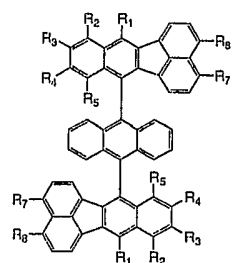

TypeEEE

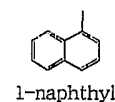

1-naphthyl

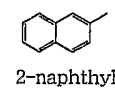

2-naphthyl

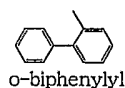

o-biphenyl

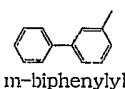

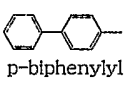

m-biphenyl





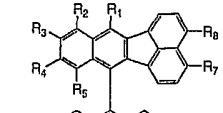
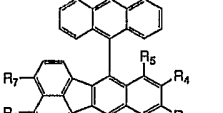

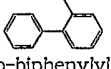
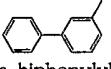
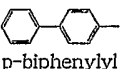

p-biphenyl

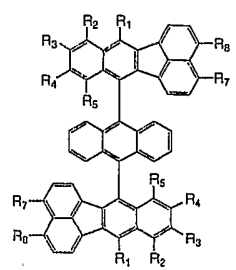
	R ₁	R ₂	R ₃	R ₄	R ₅	R ₇	R ₈
48	2-naphthyl	H	H	H	H	H	H
49	2-naphthyl	Ph	H	H	Ph	H	H
50	2-naphthyl	H	Ph	Ph	H	H	H
51	2-naphthyl	H	Ph	H	H	H	H
52	2-naphthyl	H	H	Ph	H	H	H
53	2-naphthyl	H	H	H	H	Ph	H
54	2-naphthyl	H	H	H	H	H	Ph
55	2-naphthyl	H	H	H	H	Ph	Ph
56	2-naphthyl	H	H	H	H	1-naphthyl	H
57	2-naphthyl	H	H	H	H	H	1-naphthyl
58	2-naphthyl	H	H	H	H	1-naphthyl	1-naphthyl
59	2-naphthyl	H	H	H	H	2-naphthyl	H
60	2-naphthyl	H	H	H	H	H	2-naphthyl
61	2-naphthyl	H	H	H	H	2-naphthyl	2-naphthyl
62	2-naphthyl	H	H	H	H	o-biphenyl	H
63	2-naphthyl	H	H	H	H	H	o-biphenyl
64	2-naphthyl	H	H	H	H	o-biphenyl	o-biphenyl
65	2-naphthyl	H	H	H	H	m-biphenyl	H
66	2-naphthyl	H	H	H	H	H	m-biphenyl
67	2-naphthyl	H	H	H	H	m-biphenyl	m-biphenyl
68	2-naphthyl	H	H	H	H	p-biphenyl	H
69	2-naphthyl	H	H	H	H	H	p-biphenyl
70	2-naphthyl	H	H	H	H	p-biphenyl	p-biphenyl
71	o-biphenyl	H	H	H	H	H	H
72	o-biphenyl	Ph	H	H	Ph	H	H
73	o-biphenyl	H	Ph	Ph	H	H	H
74	o-biphenyl	H	Ph	H	H	H	H
75	o-biphenyl	H	H	Ph	H	H	H
76	o-biphenyl	H	H	H	H	Ph	H
77	o-biphenyl	H	H	H	H	H	Ph
78	o-biphenyl	H	H	H	H	Ph	Ph
79	o-biphenyl	H	H	H	H	1-naphthyl	H
80	o-biphenyl	H	H	H	H	H	1-naphthyl
81	o-biphenyl	H	H	H	H	1-naphthyl	1-naphthyl
82	o-biphenyl	H	H	H	H	2-naphthyl	H
83	o-biphenyl	H	H	H	H	H	2-naphthyl
84	o-biphenyl	H	H	H	H	2-naphthyl	2-naphthyl
85	o-biphenyl	H	H	H	H	o-biphenyl	H
86	o-biphenyl	H	H	H	H	H	o-biphenyl
87	o-biphenyl	H	H	H	H	o-biphenyl	o-biphenyl
88	o-biphenyl	H	H	H	H	m-biphenyl	H
89	o-biphenyl	H	H	H	H	H	m-biphenyl
90	o-biphenyl	H	H	H	H	m-biphenyl	m-biphenyl
91	o-biphenyl	H	H	H	H	p-biphenyl	H
92	o-biphenyl	H	H	H	H	H	p-biphenyl
93	o-biphenyl	H	H	H	H	p-biphenyl	p-biphenyl

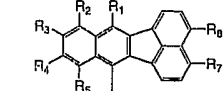
	R ₁	R ₂	R ₃	R ₄	R ₅	R ₇	R ₈
	94	m-biphenylyl	H	H	H	H	H
	95	m-biphenylyl	Ph	H	H	Ph	H
	96	m-biphenylyl	H	Ph	Ph	H	H
	97	m-biphenylyl	H	Ph	H	H	H
	98	m-biphenylyl	H	H	Ph	H	H
	99	m-biphenylyl	H	H	H	Ph	H
	100	m-biphenylyl	H	H	H	H	Ph
	101	m-biphenylyl	H	H	H	Ph	Ph
	102	m-biphenylyl	H	H	H	H	1-naphthyl
	103	m-biphenylyl	H	H	H	H	H
	104	m-biphenylyl	H	H	H	1-naphthyl	1-naphthyl
1-naphthyl	105	m-biphenylyl	H	H	H	2-naphthyl	H
	106	m-biphenylyl	H	H	H	H	2-naphthyl
2-naphthyl	107	m-biphenylyl	H	H	H	2-naphthyl	2-naphthyl
	108	m-biphenylyl	H	H	H	o-biphenylyl	H
	109	m-biphenylyl	H	H	H	H	o-biphenylyl
	110	m-biphenylyl	H	H	H	H	o-biphenylyl
o-biphenylyl	111	m-biphenylyl	H	H	H	m-biphenylyl	H
	112	m-biphenylyl	H	H	H	H	m-biphenylyl
	113	m-biphenylyl	H	H	H	m-biphenylyl	m-biphenylyl
m-biphenylyl	114	m-biphenylyl	H	H	H	p-biphenylyl	H
	115	m-biphenylyl	H	H	H	H	p-biphenylyl
	116	m-biphenylyl	H	H	H	p-biphenylyl	p-biphenylyl
p-biphenylyl	117	p-biphenylyl	H	H	H	H	H
	118	p-biphenylyl	Ph	H	H	Ph	H
	119	p-biphenylyl	H	Ph	Ph	H	H
	120	p-biphenylyl	H	Ph	H	H	H
	121	p-biphenylyl	H	H	Ph	H	H
	122	p-biphenylyl	H	H	H	Ph	H
	123	p-biphenylyl	H	H	H	H	Ph
	124	p-biphenylyl	H	H	H	Ph	Ph
	125	p-biphenylyl	H	H	H	H	1-naphthyl
	126	p-biphenylyl	H	H	H	H	H
	127	p-biphenylyl	H	H	H	1-naphthyl	1-naphthyl
	128	p-biphenylyl	H	H	H	2-naphthyl	H
	129	p-biphenylyl	H	H	H	H	2-naphthyl
	130	p-biphenylyl	H	H	H	2-naphthyl	2-naphthyl
	131	p-biphenylyl	H	H	H	o-biphenylyl	H
	132	p-biphenylyl	H	H	H	H	o-biphenylyl
	133	p-biphenylyl	H	H	H	o-biphenylyl	o-biphenylyl
	134	p-biphenylyl	H	H	H	m-biphenylyl	H
	135	p-biphenylyl	H	H	H	H	m-biphenylyl
	136	p-biphenylyl	H	H	H	m-biphenylyl	m-biphenylyl
	137	p-biphenylyl	H	H	H	p-biphenylyl	H
	138	p-biphenylyl	H	H	H	H	p-biphenylyl
	139	p-biphenylyl	H	H	H	p-biphenylyl	p-biphenylyl

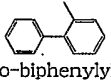
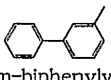
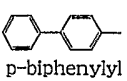
TypeEEE

	R ₁	R ₂	R ₃	R ₄	R ₅	R ₇	R ₈	
 <p>TypeEEE</p>	140	o-tolyl	H	H	H	H	H	
	141	o-tolyl	Ph	H	H	Ph	H	
	142	o-tolyl	H	Ph	Ph	H	H	
	143	o-tolyl	H	H	H	H	Ph	
	144	o-tolyl	H	H	H	H	H	
	145	o-tolyl	H	H	H	H	1-naphthyl	H
	146	o-tolyl	H	H	H	H	H	1-naphthyl
	147	o-tolyl	H	H	H	H	2-naphthyl	H
	148	o-tolyl	H	H	H	H	H	2-naphthyl
	149	o-tolyl	H	H	H	H	o-biphenyl	H
	150	o-tolyl	H	H	H	H	H	o-biphenyl
	151	o-tolyl	H	H	H	H	m-biphenyl	H
	152	o-tolyl	H	H	H	H	H	m-biphenyl
	153	o-tolyl	H	H	H	H	p-biphenyl	H
	154	o-tolyl	H	H	H	H	H	p-biphenyl
	155	o-tolyl	H	H	H	H	o-tolyl	H
	156	o-tolyl	H	H	H	H	H	o-tolyl
157	m-tolyl	H	H	H	H	H	H	
158	m-tolyl	Ph	H	H	Ph	H	H	
159	m-tolyl	H	Ph	Ph	H	H	H	
160	m-tolyl	H	H	H	H	Ph	H	
161	m-tolyl	H	H	H	H	H	Ph	
162	m-tolyl	H	H	H	H	1-naphthyl	H	
163	m-tolyl	H	H	H	H	H	1-naphthyl	
164	m-tolyl	H	H	H	H	2-naphthyl	H	
165	m-tolyl	H	H	H	H	H	2-naphthyl	
166	m-tolyl	H	H	H	H	o-biphenyl	H	
167	m-tolyl	H	H	H	H	H	o-biphenyl	
168	m-tolyl	H	H	H	H	m-biphenyl	H	
169	m-tolyl	H	H	H	H	H	m-biphenyl	
170	m-tolyl	H	H	H	H	p-biphenyl	H	
171	m-tolyl	H	H	H	H	H	p-biphenyl	
172	m-tolyl	H	H	H	H	m-tolyl	H	
173	m-tolyl	H	H	H	H	H	m-tolyl	
174	p-tolyl	H	H	H	H	H	H	
175	p-tolyl	Ph	H	H	Ph	H	H	
176	p-tolyl	H	Ph	Ph	H	H	H	
177	p-tolyl	H	H	H	H	Ph	H	
178	p-tolyl	H	H	H	H	H	Ph	
179	p-tolyl	H	H	H	H	1-naphthyl	H	
180	p-tolyl	H	H	H	H	H	1-naphthyl	
181	p-tolyl	H	H	H	H	2-naphthyl	H	
182	p-tolyl	H	H	H	H	H	2-naphthyl	
183	p-tolyl	H	H	H	H	o-biphenyl	H	
184	p-tolyl	H	H	H	H	H	o-biphenyl	
185	p-tolyl	H	H	H	H	m-biphenyl	H	
186	p-tolyl	H	H	H	H	H	m-biphenyl	
187	p-tolyl	H	H	H	H	p-biphenyl	H	
188	p-tolyl	H	H	H	H	H	p-biphenyl	
189	p-tolyl	H	H	H	H	p-tolyl	H	
190	p-tolyl	H	H	H	H	H	p-tolyl	

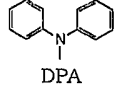
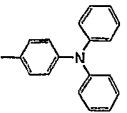
	R ₁	R ₂	R ₃	R ₄	R ₅	R ₇	R ₈
	191	Ph	H	-CH3	-CH3	H	H
	192	1-naphtyl	H	-CH3	-CH3	H	H
	193	2-naphtyl	H	-CH3	-CH3	H	H
	194	o-biphenylyl	H	-CH3	-CH3	H	H
	195	m-biphenylyl	H	-CH3	-CH3	H	H
	196	p-biphenylyl	H	-CH3	-CH3	H	H
	197	o-tolyl	H	-CH3	-CH3	H	H
	198	m-tolyl	H	-CH3	-CH3	H	H
	199	p-tolyl	H	-CH3	-CH3	H	H
TypeEEE	200	Ph	H	H	H	-CH3	H
	201	1-naphtyl	H	H	H	-CH3	H
	202	2-naphtyl	H	H	H	-CH3	H
	203	o-biphenylyl	H	H	H	-CH3	H
	204	m-biphenylyl	H	H	H	-CH3	H
	205	p-biphenylyl	H	H	H	-CH3	H
	206	o-tolyl	H	H	H	-CH3	H
	207	m-tolyl	H	H	H	-CH3	H
	208	p-tolyl	H	H	H	-CH3	H
	209	Ph	H	H	H	H	-CH3
	210	1-naphtyl	H	H	H	H	-CH3
	211	2-naphtyl	H	H	H	H	-CH3
	212	o-biphenylyl	H	H	H	H	-CH3
	213	m-biphenylyl	H	H	H	H	-CH3
1-naphtyl	214	p-biphenylyl	H	H	H	H	-CH3
	215	o-tolyl	H	H	H	H	-CH3
	216	m-tolyl	H	H	H	H	-CH3
2-naphtyl	217	p-tolyl	H	H	H	H	-CH3
	218	Ph	H	H	H	-CH3	-CH3
	219	1-naphtyl	H	H	H	-CH3	-CH3
	220	2-naphtyl	H	H	H	-CH3	-CH3
o-biphenylyl	221	o-biphenylyl	H	H	H	-CH3	-CH3
	222	m-biphenylyl	H	H	H	-CH3	-CH3
	223	p-biphenylyl	H	H	H	-CH3	-CH3
m-biphenylyl	224	o-tolyl	H	H	H	-CH3	-CH3
	225	m-tolyl	H	H	H	-CH3	-CH3
	226	p-tolyl	H	H	H	-CH3	-CH3
p-biphenylyl	227	Ph	H	H	H	H	DPA
	228	1-naphtyl	H	H	H	H	DPA
	229	2-naphtyl	H	H	H	H	DPA
	230	o-biphenylyl	H	H	H	H	DPA
o-tolyl	231	m-biphenylyl	H	H	H	H	DPA
	232	p-biphenylyl	H	H	H	H	DPA
	233	Ph	H	H	H	DPA	H
m-tolyl	234	1-naphtyl	H	H	H	DPA	H
	235	2-naphtyl	H	H	H	DPA	H
	236	o-biphenylyl	H	H	H	DPA	H
	237	m-biphenylyl	H	H	H	DPA	H
p-tolyl	238	p-biphenylyl	H	H	H	DPA	H
	239	Ph	H	H	H	H	TPA
	240	1-naphtyl	H	H	H	H	TPA
DPA	241	2-naphtyl	H	H	H	H	TPA
	242	o-biphenylyl	H	H	H	H	TPA
	243	m-biphenylyl	H	H	H	H	TPA
	244	p-biphenylyl	H	H	H	H	TPA
	245	Ph	H	H	H	TPA	H
TPA	246	1-naphtyl	H	H	H	TPA	H
	247	2-naphtyl	H	H	H	TPA	H
	248	o-biphenylyl	H	H	H	TPA	H
	249	m-biphenylyl	H	H	H	TPA	H
	250	p-biphenylyl	H	H	H	TPA	H

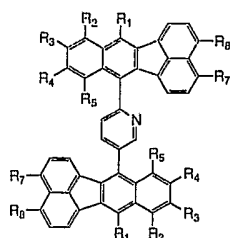

TypeLLL

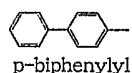
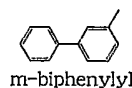
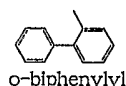
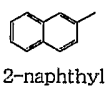
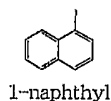

	R ₁	R ₂	R ₃	R ₄	R ₅	R ₇	R ₈
1	H	H	H	H	H	H	H
2	Ph	H	H	H	H	H	H
3	Ph	Ph	H	H	Ph	H	H
4	Ph	H	Ph	Ph	H	H	H
5	Ph	H	Ph	H	H	H	H
6	Ph	H	H	Ph	H	H	H
7	Ph	H	H	H	H	Ph	H
8	Ph	H	H	H	H	H	Ph
9	Ph	H	H	H	H	Ph	Ph
10	Ph	H	H	H	H	1-naphthyl	H
11	Ph	H	H	H	H	H	1-naphthyl
12	Ph	H	H	H	H	1-naphthyl	1-naphthyl
13	Ph	H	H	H	H	2-naphthyl	H
14	Ph	H	H	H	H	H	2-naphthyl
15	Ph	H	H	H	H	2-naphthyl	2-naphthyl
16	Ph	H	H	H	H	o-biphenyl	H
17	Ph	H	H	H	H	H	o-biphenyl
18	Ph	H	H	H	H	o-biphenyl	o-biphenyl
19	Ph	H	H	H	H	m-biphenyl	H
20	Ph	H	H	H	H	H	m-biphenyl
21	Ph	H	H	H	H	m-biphenyl	m-biphenyl
22	Ph	H	H	H	H	p-biphenyl	H
23	Ph	H	H	H	H	H	p-biphenyl
24	Ph	H	H	H	H	p-biphenyl	p-biphenyl
25	1-naphthyl	H	H	H	H	H	H
26	1-naphthyl	Ph	H	H	Ph	H	H
27	1-naphthyl	H	Ph	Ph	H	H	H
28	1-naphthyl	H	Ph	H	H	H	H
29	1-naphthyl	H	H	Ph	H	H	H
30	1-naphthyl	H	H	H	H	Ph	H
31	1-naphthyl	H	H	H	H	H	Ph
32	1-naphthyl	H	H	H	H	Ph	Ph
33	1-naphthyl	H	H	H	H	1-naphthyl	H
34	1-naphthyl	H	H	H	H	H	1-naphthyl
35	1-naphthyl	H	H	H	H	1-naphthyl	1-naphthyl
36	1-naphthyl	H	H	H	H	2-naphthyl	H
37	1-naphthyl	H	H	H	H	H	2-naphthyl
38	1-naphthyl	H	H	H	H	2-naphthyl	2-naphthyl
39	1-naphthyl	H	H	H	H	o-biphenyl	H
40	1-naphthyl	H	H	H	H	H	o-biphenyl
41	1-naphthyl	H	H	H	H	o-biphenyl	o-biphenyl
42	1-naphthyl	H	H	H	H	m-biphenyl	H
43	1-naphthyl	H	H	H	H	H	m-biphenyl
44	1-naphthyl	H	H	H	H	m-biphenyl	m-biphenyl
45	1-naphthyl	H	H	H	H	p-biphenyl	H
46	1-naphthyl	H	H	H	H	H	p-biphenyl
47	1-naphthyl	H	H	H	H	p-biphenyl	p-biphenyl

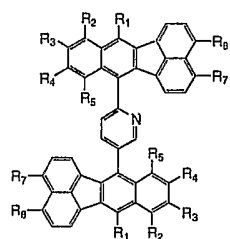

TypeLLL

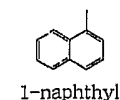

1-naphthyl



2-naphthyl

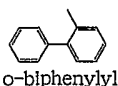

o-biphenyl

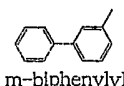

m-biphenyl

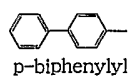

p-biphenyl

	R ₁	R ₂	R ₃	R ₄	R ₅	R ₇	R ₈
48	2-naphthyl	H	H	H	H	H	H
49	2-naphthyl	Ph	H	H	Ph	H	H
50	2-naphthyl	H	Ph	Ph	H	H	H
51	2-naphthyl	H	Ph	H	H	H	H
52	2-naphthyl	H	H	Ph	H	H	H
53	2-naphthyl	H	H	H	H	Ph	H
54	2-naphthyl	H	H	H	H	H	Ph
55	2-naphthyl	H	H	H	H	Ph	Ph
56	2-naphthyl	H	H	H	H	1-naphthyl	H
57	2-naphthyl	H	H	H	H	H	1-naphthyl
58	2-naphthyl	H	H	H	H	1-naphthyl	1-naphthyl
59	2-naphthyl	H	H	H	H	2-naphthyl	H
60	2-naphthyl	H	H	H	H	H	2-naphthyl
61	2-naphthyl	H	H	H	H	2-naphthyl	2-naphthyl
62	2-naphthyl	H	H	H	H	o-biphenyl	H
63	2-naphthyl	H	H	H	H	H	o-biphenyl
64	2-naphthyl	H	H	H	H	o-biphenyl	o-biphenyl
65	2-naphthyl	H	H	H	H	m-biphenyl	H
66	2-naphthyl	H	H	H	H	H	m-biphenyl
67	2-naphthyl	H	H	H	H	m-biphenyl	m-biphenyl
68	2-naphthyl	H	H	H	H	p-biphenyl	H
69	2-naphthyl	H	H	H	H	H	p-biphenyl
70	2-naphthyl	H	H	H	H	p-biphenyl	p-biphenyl
71	o-biphenyl	H	H	H	H	H	H
72	o-biphenyl	Ph	H	H	Ph	H	H
73	o-biphenyl	H	Ph	Ph	H	H	H
74	o-biphenyl	H	Ph	H	H	H	H
75	o-biphenyl	H	H	Ph	H	H	H
76	o-biphenyl	H	H	H	H	Ph	H
77	o-biphenyl	H	H	H	H	H	Ph
78	o-biphenyl	H	H	H	H	Ph	Ph
79	o-biphenyl	H	H	H	H	1-naphthyl	H
80	o-biphenyl	H	H	H	H	H	1-naphthyl
81	o-biphenyl	H	H	H	H	1-naphthyl	1-naphthyl
82	o-biphenyl	H	H	H	H	2-naphthyl	H
83	o-biphenyl	H	H	H	H	H	2-naphthyl
84	o-biphenyl	H	H	H	H	2-naphthyl	2-naphthyl
85	o-biphenyl	H	H	H	H	o-biphenyl	H
86	o-biphenyl	H	H	H	H	H	o-biphenyl
87	o-biphenyl	H	H	H	H	o-biphenyl	o-biphenyl
88	o-biphenyl	H	H	H	H	m-biphenyl	H
89	o-biphenyl	H	H	H	H	H	m-biphenyl
90	o-biphenyl	H	H	H	H	m-biphenyl	m-biphenyl
91	o-biphenyl	H	H	H	H	p-biphenyl	H
92	o-biphenyl	H	H	H	H	H	p-biphenyl
93	o-biphenyl	H	H	H	H	p-biphenyl	p-biphenyl

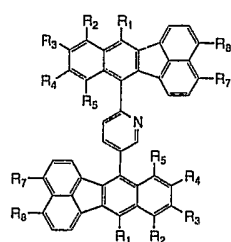

TypeLLL

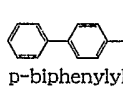
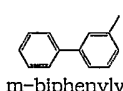
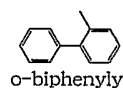
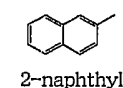
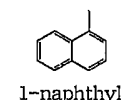

	R ₁	R ₂	R ₃	R ₄	R ₅	R ₇	R ₈
94	m-biphenyl	H	H	H	H	H	H
95	m-biphenyl	Ph	H	H	Ph	H	H
96	m-biphenyl	H	Ph	Ph	H	H	H
97	m-biphenyl	H	Ph	H	H	H	H
98	m-biphenyl	H	H	Ph	H	H	H
99	m-biphenyl	H	H	H	H	Ph	H
100	m-biphenyl	H	H	H	H	H	Ph
101	m-biphenyl	H	H	H	H	Ph	Ph
102	m-biphenyl	H	H	H	H	1-naphthyl	H
103	m-biphenyl	H	H	H	H	H	1-naphthyl
104	m-biphenyl	H	H	H	H	1-naphthyl	1-naphthyl
105	m-biphenyl	H	H	H	H	2-naphthyl	H
106	m-biphenyl	H	H	H	H	H	2-naphthyl
107	m-biphenyl	H	H	H	H	2-naphthyl	2-naphthyl
108	m-biphenyl	H	H	H	H	o-biphenyl	H
109	m-biphenyl	H	H	H	H	H	o-biphenyl
110	m-biphenyl	H	H	H	H	o-biphenyl	o-biphenyl
111	m-biphenyl	H	H	H	H	m-biphenyl	H
112	m-biphenyl	H	H	H	H	H	m-biphenyl
113	m-biphenyl	H	H	H	H	m-biphenyl	m-biphenyl
114	m-biphenyl	H	H	H	H	p-biphenyl	H
115	m-biphenyl	H	H	H	H	H	p-biphenyl
116	m-biphenyl	H	H	H	H	p-biphenyl	p-biphenyl
117	p-biphenyl	H	H	H	H	H	H
118	p-biphenyl	Ph	H	H	Ph	H	H
119	p-biphenyl	H	Ph	Ph	H	H	H
120	p-biphenyl	H	Ph	H	H	H	H
121	p-biphenyl	H	H	Ph	H	H	H
122	p-biphenyl	H	H	H	H	Ph	H
123	p-biphenyl	H	H	H	H	H	Ph
124	p-biphenyl	H	H	H	H	Ph	Ph
125	p-biphenyl	H	H	H	H	1-naphthyl	H
126	p-biphenyl	H	H	H	H	H	1-naphthyl
127	p-biphenyl	H	H	H	H	1-naphthyl	1-naphthyl
128	p-biphenyl	H	H	H	H	2-naphthyl	H
129	p-biphenyl	H	H	H	H	H	2-naphthyl
130	p-biphenyl	H	H	H	H	2-naphthyl	2-naphthyl
131	p-biphenyl	H	H	H	H	o-biphenyl	H
132	p-biphenyl	H	H	H	H	H	o-biphenyl
133	p-biphenyl	H	H	H	H	o-biphenyl	o-biphenyl
134	p-biphenyl	H	H	H	H	m-biphenyl	H
135	p-biphenyl	H	H	H	H	H	m-biphenyl
136	p-biphenyl	H	H	H	H	m-biphenyl	m-biphenyl
137	p-biphenyl	H	H	H	H	p-biphenyl	H
138	p-biphenyl	H	H	H	H	H	p-biphenyl
139	p-biphenyl	H	H	H	H	p-biphenyl	p-biphenyl

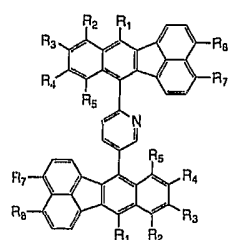

TypeLLL

	R ₁	R ₂	R ₃	R ₄	R ₅	R ₇	R ₈
140	o-tolyl	H	H	H	H	H	H
141	o-tolyl	Ph	H	H	Ph	H	H
142	o-tolyl	H	Ph	Ph	H	H	H
143	o-tolyl	H	H	H	H	Ph	H
144	o-tolyl	H	H	H	H	H	Ph
145	o-tolyl	H	H	H	H	1-naphthyl	H
146	o-tolyl	H	H	H	H	H	1-naphthyl
147	o-tolyl	H	H	H	H	2-naphthyl	H
148	o-tolyl	H	H	H	H	H	2-naphthyl
149	o-tolyl	H	H	H	H	o-biphenyl	H
150	o-tolyl	H	H	H	H	H	o-biphenyl
151	o-tolyl	H	H	H	H	m-biphenyl	H
152	o-tolyl	H	H	H	H	H	m-biphenyl
153	o-tolyl	H	H	H	H	p-biphenyl	H
154	o-tolyl	H	H	H	H	H	p-biphenyl
155	o-tolyl	H	H	H	H	o-tolyl	H
156	o-tolyl	H	H	H	H	H	o-tolyl
157	m-tolyl	H	H	H	H	H	H
158	m-tolyl	Ph	H	H	Ph	H	H
159	m-tolyl	H	Ph	Ph	H	H	H
160	m-tolyl	H	H	H	H	Ph	H
161	m-tolyl	H	H	H	H	H	Ph
162	m-tolyl	H	H	H	H	1-naphthyl	H
163	m-tolyl	H	H	H	H	H	1-naphthyl
164	m-tolyl	H	H	H	H	2-naphthyl	H
165	m-tolyl	H	H	H	H	H	2-naphthyl
166	m-tolyl	H	H	H	H	o-biphenyl	H
167	m-tolyl	H	H	H	H	H	o-biphenyl
168	m-tolyl	H	H	H	H	m-biphenyl	H
169	m-tolyl	H	H	H	H	H	m-biphenyl
170	m-tolyl	H	H	H	H	p-biphenyl	H
171	m-tolyl	H	H	H	H	H	p-biphenyl
172	m-tolyl	H	H	H	H	m-tolyl	H
173	m-tolyl	H	H	H	H	H	m-tolyl
174	p-tolyl	H	H	H	H	H	H
175	p-tolyl	Ph	H	H	Ph	H	H
176	p-tolyl	H	Ph	Ph	H	H	H
177	p-tolyl	H	H	H	H	Ph	H
178	p-tolyl	H	H	H	H	H	Ph
179	p-tolyl	H	H	H	H	1-naphthyl	H
180	p-tolyl	H	H	H	H	H	1-naphthyl
181	p-tolyl	H	H	H	H	2-naphthyl	H
182	p-tolyl	H	H	H	H	H	2-naphthyl
183	p-tolyl	H	H	H	H	o-biphenyl	H
184	p-tolyl	H	H	H	H	H	o-biphenyl
185	p-tolyl	H	H	H	H	m-biphenyl	H
186	p-tolyl	H	H	H	H	H	m-biphenyl
187	p-tolyl	H	H	H	H	p-biphenyl	H
188	p-tolyl	H	H	H	H	H	p-biphenyl
189	p-tolyl	H	H	H	H	p-tolyl	H
190	p-tolyl	H	H	H	H	H	p-tolyl

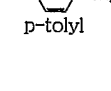
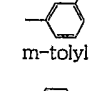
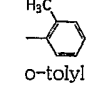
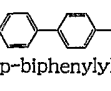
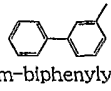
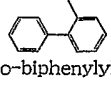
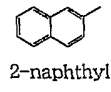
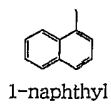

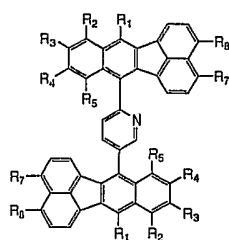

TypeLLL

	R ₁	R ₂	R ₃	R ₄	R ₅	R ₇	R ₈
191	Ph	H	-CH ₃	-CH ₃	H	H	H
192	1-naphthyl	H	-CH ₃	-CH ₃	H	H	H
193	2-naphthyl	H	-CH ₃	-CH ₃	H	H	H
194	o-biphenyl	H	-CH ₃	-CH ₃	H	H	H
195	m-biphenyl	H	-CH ₃	-CH ₃	H	H	H
196	p-biphenyl	H	-CH ₃	-CH ₃	H	H	H
197	o-tolyl	H	-CH ₃	-CH ₃	H	H	H
198	m-tolyl	H	-CH ₃	-CH ₃	H	H	H
199	p-tolyl	H	-CH ₃	-CH ₃	H	H	H
200	Ph	H	H	H	H	-CH ₃	H
201	1-naphthyl	H	H	H	H	-CH ₃	H
202	2-naphthyl	H	H	H	H	-CH ₃	H
203	o-biphenyl	H	H	H	H	-CH ₃	H
204	m-biphenyl	H	H	H	H	-CH ₃	H
205	p-biphenyl	H	H	H	H	-CH ₃	H
206	o-tolyl	H	H	H	H	-CH ₃	H
207	m-tolyl	H	H	H	H	-CH ₃	H
208	p-tolyl	H	H	H	H	-CH ₃	H
209	Ph	H	H	H	H	H	-CH ₃
210	1-naphthyl	H	H	H	H	H	-CH ₃
211	2-naphthyl	H	H	H	H	H	-CH ₃
212	o-biphenyl	H	H	H	H	H	-CH ₃
213	m-biphenyl	H	H	H	H	H	-CH ₃
214	p-biphenyl	H	H	H	H	H	-CH ₃
215	o-tolyl	H	H	H	H	H	-CH ₃
216	m-tolyl	H	H	H	H	H	-CH ₃
217	p-tolyl	H	H	H	H	H	-CH ₃
218	Ph	H	H	H	H	-CH ₃	-CH ₃
219	1-naphthyl	H	H	H	H	-CH ₃	-CH ₃
220	2-naphthyl	H	H	H	H	-CH ₃	-CH ₃
221	o-biphenyl	H	H	H	H	-CH ₃	-CH ₃
222	m-biphenyl	H	H	H	H	-CH ₃	-CH ₃
223	p-biphenyl	H	H	H	H	-CH ₃	-CH ₃
224	o-tolyl	H	H	H	H	-CH ₃	-CH ₃
225	m-tolyl	H	H	H	H	-CH ₃	-CH ₃
226	p-tolyl	H	H	H	H	-CH ₃	-CH ₃
227	Ph	H	H	H	H	H	DPA
228	1-naphthyl	H	H	H	H	H	DPA
229	2-naphthyl	H	H	H	H	H	DPA
230	o-biphenyl	H	H	H	H	H	DPA
231	m-biphenyl	H	H	H	H	H	DPA
232	p-biphenyl	H	H	H	H	H	DPA
233	Ph	H	H	H	H	DPA	H
234	1-naphthyl	H	H	H	H	DPA	H
235	2-naphthyl	H	H	H	H	DPA	H
236	o-biphenyl	H	H	H	H	DPA	H
237	m-biphenyl	H	H	H	H	DPA	H
238	p-biphenyl	H	H	H	H	DPA	H
239	Ph	H	H	H	H	H	TPA
240	1-naphthyl	H	H	H	H	H	TPA
241	2-naphthyl	H	H	H	H	H	TPA
242	o-biphenyl	H	H	H	H	H	TPA
243	m-biphenyl	H	H	H	H	H	TPA
244	p-biphenyl	H	H	H	H	H	TPA
245	Ph	H	H	H	H	TPA	H
246	1-naphthyl	H	H	H	H	TPA	H
247	2-naphthyl	H	H	H	H	TPA	H
248	o-biphenyl	H	H	H	H	TPA	H
249	m-biphenyl	H	H	H	H	TPA	H
250	p-biphenyl	H	H	H	H	TPA	H

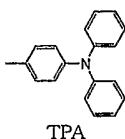
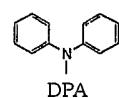
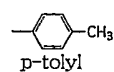
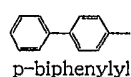
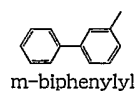
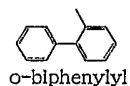
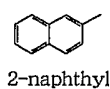
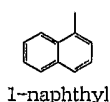

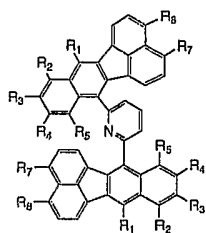

TypeMMM

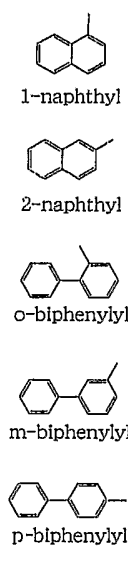

	R ₁	R ₂	R ₃	R ₄	R ₅	R ₇	R ₈
1	H	H	H	H	H	H	H
2	Ph	H	H	H	H	H	H
3	Ph	Ph	H	H	Ph	H	H
4	Ph	H	Ph	Ph	H	H	H
5	Ph	H	Ph	H	H	H	H
6	Ph	H	H	Ph	H	H	H
7	Ph	H	H	H	H	Ph	H
8	Ph	H	H	H	H	H	Ph
9	Ph	H	H	H	H	Ph	Ph
10	Ph	H	H	H	H	1-naphthyl	H
11	Ph	H	H	H	H	H	1-naphthyl
12	Ph	H	H	H	H	1-naphthyl	1-naphthyl
13	Ph	H	H	H	H	2-naphthyl	H
14	Ph	H	H	H	H	H	2-naphthyl
15	Ph	H	H	H	H	2-naphthyl	2-naphthyl
16	Ph	H	H	H	H	o-biphenyl	H
17	Ph	H	H	H	H	H	o-biphenyl
18	Ph	H	H	H	H	o-biphenyl	o-biphenyl
19	Ph	H	H	H	H	m-biphenyl	H
20	Ph	H	H	H	H	H	m-biphenyl
21	Ph	H	H	H	H	m-biphenyl	m-biphenyl
22	Ph	H	H	H	H	p-biphenyl	H
23	Ph	H	H	H	H	H	p-biphenyl
24	Ph	H	H	H	H	p-biphenyl	p-biphenyl
25	1-naphthyl	H	H	H	H	H	H
26	1-naphthyl	Ph	H	H	Ph	H	H
27	1-naphthyl	H	Ph	Ph	H	H	H
28	1-naphthyl	H	Ph	H	H	H	H
29	1-naphthyl	H	H	Ph	H	H	H
30	1-naphthyl	H	H	H	H	Ph	H
31	1-naphthyl	H	H	H	H	H	Ph
32	1-naphthyl	H	H	H	H	Ph	Ph
33	1-naphthyl	H	H	H	H	1-naphthyl	H
34	1-naphthyl	H	H	H	H	H	1-naphthyl
35	1-naphthyl	H	H	H	H	1-naphthyl	1-naphthyl
36	1-naphthyl	H	H	H	H	2-naphthyl	H
37	1-naphthyl	H	H	H	H	H	2-naphthyl
38	1-naphthyl	H	H	H	H	2-naphthyl	2-naphthyl
39	1-naphthyl	H	H	H	H	o-biphenyl	H
40	1-naphthyl	H	H	H	H	H	o-biphenyl
41	1-naphthyl	H	H	H	H	o-biphenyl	o-biphenyl
42	1-naphthyl	H	H	H	H	m-biphenyl	H
43	1-naphthyl	H	H	H	H	H	m-biphenyl
44	1-naphthyl	H	H	H	H	m-biphenyl	m-biphenyl
45	1-naphthyl	H	H	H	H	p-biphenyl	H
46	1-naphthyl	H	H	H	H	H	p-biphenyl
47	1-naphthyl	H	H	H	H	p-biphenyl	p-biphenyl

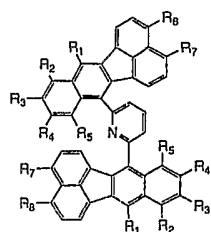

TypeMMM

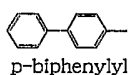
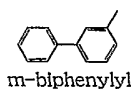
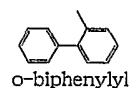
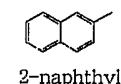
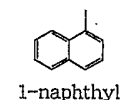

	R ₁	R ₂	R ₃	R ₄	R ₅	R ₇	R ₈
48	2-naphthyl	H	H	H	H	H	H
49	2-naphthyl	Ph	H	H	Ph	H	H
50	2-naphthyl	H	Ph	Ph	H	H	H
51	2-naphthyl	H	Ph	H	H	H	H
52	2-naphthyl	H	H	Ph	H	H	H
53	2-naphthyl	H	H	H	H	Ph	H
54	2-naphthyl	H	H	H	H	H	Ph
55	2-naphthyl	H	H	H	H	Ph	Ph
56	2-naphthyl	H	H	H	H	1-naphthyl	H
57	2-naphthyl	H	H	H	H	H	1-naphthyl
58	2-naphthyl	H	H	H	H	1-naphthyl	1-naphthyl
59	2-naphthyl	H	H	H	H	2-naphthyl	H
60	2-naphthyl	H	H	H	H	H	2-naphthyl
61	2-naphthyl	H	H	H	H	2-naphthyl	2-naphthyl
62	2-naphthyl	H	H	H	H	o-biphenyl	H
63	2-naphthyl	H	H	H	H	H	o-biphenyl
64	2-naphthyl	H	H	H	H	o-biphenyl	o-biphenyl
65	2-naphthyl	H	H	H	H	m-biphenyl	H
66	2-naphthyl	H	H	H	H	H	m-biphenyl
67	2-naphthyl	H	H	H	H	m-biphenyl	m-biphenyl
68	2-naphthyl	H	H	H	H	p-biphenyl	H
69	2-naphthyl	H	H	H	H	H	p-biphenyl
70	2-naphthyl	H	H	H	H	p-biphenyl	p-biphenyl
71	o-biphenyl	H	H	H	H	H	H
72	o-biphenyl	Ph	H	H	Ph	H	H
73	o-biphenyl	H	Ph	Ph	H	H	H
74	o-biphenyl	H	Ph	H	H	H	H
75	o-biphenyl	H	H	Ph	H	H	H
76	o-biphenyl	H	H	H	H	Ph	H
77	o-biphenyl	H	H	H	H	H	Ph
78	o-biphenyl	H	H	H	H	Ph	Ph
79	o-biphenyl	H	H	H	H	1-naphthyl	H
80	o-biphenyl	H	H	H	H	H	1-naphthyl
81	o-biphenyl	H	H	H	H	1-naphthyl	1-naphthyl
82	o-biphenyl	H	H	H	H	2-naphthyl	H
83	o-biphenyl	H	H	H	H	H	2-naphthyl
84	o-biphenyl	H	H	H	H	2-naphthyl	2-naphthyl
85	o-biphenyl	H	H	H	H	o-biphenyl	H
86	o-biphenyl	H	H	H	H	H	o-biphenyl
87	o-biphenyl	H	H	H	H	o-biphenyl	o-biphenyl
88	o-biphenyl	H	H	H	H	m-biphenyl	H
89	o-biphenyl	H	H	H	H	H	m-biphenyl
90	o-biphenyl	H	H	H	H	m-biphenyl	m-biphenyl
91	o-biphenyl	H	H	H	H	p-biphenyl	H
92	o-biphenyl	H	H	H	H	H	p-biphenyl
93	o-biphenyl	H	H	H	H	p-biphenyl	p-biphenyl

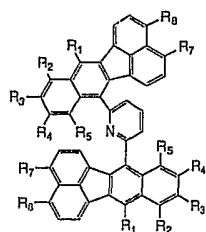

TypeMMM

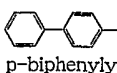
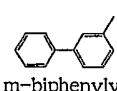
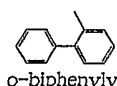
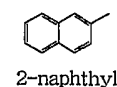
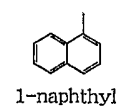

	R ₁	R ₂	R ₃	R ₄	R ₅	R ₇	R ₈
94	m-biphenyl	H	H	H	H	H	H
95	m-biphenyl	Ph	H	H	Ph	H	H
96	m-biphenyl	H	Ph	Ph	H	H	H
97	m-biphenyl	H	Ph	H	H	H	H
98	m-biphenyl	H	H	Ph	H	H	H
99	m-biphenyl	H	H	H	H	Ph	H
100	m-biphenyl	H	H	H	H	H	Ph
101	m-biphenyl	H	H	H	H	Ph	Ph
102	m-biphenyl	H	H	H	H	1-naphthyl	H
103	m-biphenyl	H	H	H	H	H	1-naphthyl
104	m-biphenyl	H	H	H	H	1-naphthyl	1-naphthyl
105	m-biphenyl	H	H	H	H	2-naphthyl	H
106	m-biphenyl	H	H	H	H	H	2-naphthyl
107	m-biphenyl	H	H	H	H	2-naphthyl	2-naphthyl
108	m-biphenyl	H	H	H	H	o-biphenyl	H
109	m-biphenyl	H	H	H	H	H	o-biphenyl
110	m-biphenyl	H	H	H	H	o-biphenyl	o-biphenyl
111	m-biphenyl	H	H	H	H	m-biphenyl	H
112	m-biphenyl	H	H	H	H	H	m-biphenyl
113	m-biphenyl	H	H	H	H	m-biphenyl	m-biphenyl
114	m-biphenyl	H	H	H	H	p-biphenyl	H
115	m-biphenyl	H	H	H	H	H	p-biphenyl
116	m-biphenyl	H	H	H	H	p-biphenyl	p-biphenyl
117	p-biphenyl	H	H	H	H	H	H
118	p-biphenyl	Ph	H	H	Ph	H	H
119	p-biphenyl	H	Ph	Ph	H	H	H
120	p-biphenyl	H	Ph	H	H	H	H
121	p-biphenyl	H	H	Ph	H	H	H
122	p-biphenyl	H	H	H	H	Ph	H
123	p-biphenyl	H	H	H	H	H	Ph
124	p-biphenyl	H	H	H	H	Ph	Ph
125	p-biphenyl	H	H	H	H	1-naphthyl	H
126	p-biphenyl	H	H	H	H	H	1-naphthyl
127	p-biphenyl	H	H	H	H	1-naphthyl	1-naphthyl
128	p-biphenyl	H	H	H	H	2-naphthyl	H
129	p-biphenyl	H	H	H	H	H	2-naphthyl
130	p-biphenyl	H	H	H	H	2-naphthyl	2-naphthyl
131	p-biphenyl	H	H	H	H	o-biphenyl	H
132	p-biphenyl	H	H	H	H	H	o-biphenyl
133	p-biphenyl	H	H	H	H	o-biphenyl	o-biphenyl
134	p-biphenyl	H	H	H	H	m-biphenyl	H
135	p-biphenyl	H	H	H	H	H	m-biphenyl
136	p-biphenyl	H	H	H	H	m-biphenyl	m-biphenyl
137	p-biphenyl	H	H	H	H	p-biphenyl	H
138	p-biphenyl	H	H	H	H	H	p-biphenyl
139	p-biphenyl	H	H	H	H	p-biphenyl	p-biphenyl

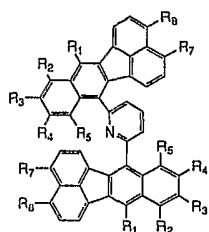

TypeMMM

	R ₁	R ₂	R ₃	R ₄	R ₅	R ₇	R ₈
140	o-tolyl	H	H	H	H	H	H
141	o-tolyl	Ph	H	H	Ph	H	H
142	o-tolyl	H	Ph	Ph	H	H	H
143	o-tolyl	H	H	H	H	Ph	H
144	o-tolyl	H	H	H	H	H	Ph
145	o-tolyl	H	H	H	H	1-naphthyl	H
146	o-tolyl	H	H	H	H	H	1-naphthyl
147	o-tolyl	H	H	H	H	2-naphthyl	H
148	o-tolyl	H	H	H	H	H	2-naphthyl
149	o-tolyl	H	H	H	H	o-biphenyl	H
150	o-tolyl	H	H	H	H	H	o-biphenyl
151	o-tolyl	H	H	H	H	m-biphenyl	H
152	o-tolyl	H	H	H	H	H	m-biphenyl
153	o-tolyl	H	H	H	H	p-biphenyl	H
154	o-tolyl	H	H	H	H	H	p-biphenyl
155	o-tolyl	H	H	H	H	o-tolyl	H
156	o-tolyl	H	H	H	H	H	o-tolyl
157	m-tolyl	H	H	H	H	H	H
158	m-tolyl	Ph	H	H	Ph	H	H
159	m-tolyl	H	Ph	Ph	H	H	H
160	m-tolyl	H	H	H	H	Ph	H
161	m-tolyl	H	H	H	H	H	Ph
162	m-tolyl	H	H	H	H	1-naphthyl	H
163	m-tolyl	H	H	H	H	H	1-naphthyl
164	m-tolyl	H	H	H	H	2-naphthyl	H
165	m-tolyl	H	H	H	H	H	2-naphthyl
166	m-tolyl	H	H	H	H	o-biphenyl	H
167	m-tolyl	H	H	H	H	H	o-biphenyl
168	m-tolyl	H	H	H	H	m-biphenyl	H
169	m-tolyl	H	H	H	H	H	m-biphenyl
170	m-tolyl	H	H	H	H	p-biphenyl	H
171	m-tolyl	H	H	H	H	H	p-biphenyl
172	m-tolyl	H	H	H	H	m-tolyl	H
173	m-tolyl	H	H	H	H	H	m-tolyl
174	p-tolyl	H	H	H	H	H	H
175	p-tolyl	Ph	H	H	Ph	H	H
176	p-tolyl	H	Ph	Ph	H	H	H
177	p-tolyl	H	H	H	H	Ph	H
178	p-tolyl	H	H	H	H	H	Ph
179	p-tolyl	H	H	H	H	1-naphthyl	H
180	p-tolyl	H	H	H	H	H	1-naphthyl
181	p-tolyl	H	H	H	H	2-naphthyl	H
182	p-tolyl	H	H	H	H	H	2-naphthyl
183	p-tolyl	H	H	H	H	o-biphenyl	H
184	p-tolyl	H	H	H	H	H	o-biphenyl
185	p-tolyl	H	H	H	H	m-biphenyl	H
186	p-tolyl	H	H	H	H	H	m-biphenyl
187	p-tolyl	H	H	H	H	p-biphenyl	H
188	p-tolyl	H	H	H	H	H	p-biphenyl
189	p-tolyl	H	H	H	H	p-tolyl	H
190	p-tolyl	H	H	H	H	H	p-tolyl

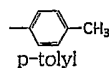
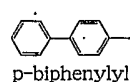
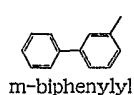
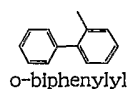
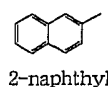
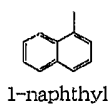

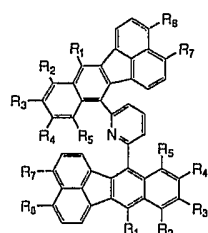

TypeMMM

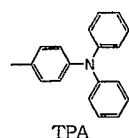
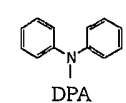
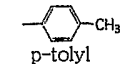
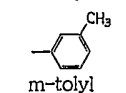
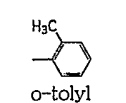
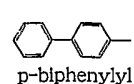
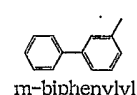
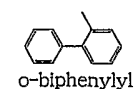
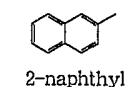
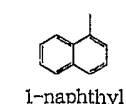

	R ₁	R ₂	R ₃	R ₄	R ₅	R ₇	R ₈
191	Ph	H	-CH ₃	-CH ₃	H	H	H
192	1-naphtyl	H	-CH ₃	-CH ₃	H	H	H
193	2-naphtyl	H	-CH ₃	-CH ₃	H	H	H
194	o-biphenyl	H	-CH ₃	-CH ₃	H	H	H
195	m-biphenyl	H	-CH ₃	-CH ₃	H	H	H
196	p-biphenyl	H	-CH ₃	-CH ₃	H	H	H
197	o-tolyl	H	-CH ₃	-CH ₃	H	H	H
198	m-tolyl	H	-CH ₃	-CH ₃	H	H	H
199	p-tolyl	H	-CH ₃	-CH ₃	H	H	H
200	Ph	H	H	H	H	-CH ₃	H
201	1-naphtyl	H	H	H	H	-CH ₃	H
202	2-naphtyl	H	H	H	H	-CH ₃	H
203	o-biphenyl	H	H	H	H	-CH ₃	H
204	m-biphenyl	H	H	H	H	-CH ₃	H
205	p-biphenyl	H	H	H	H	-CH ₃	H
206	o-tolyl	H	H	H	H	-CH ₃	H
207	m-tolyl	H	H	H	H	-CH ₃	H
208	p-tolyl	H	H	H	H	-CH ₃	H
209	Ph	H	H	H	H	H	-CH ₃
210	1-naphtyl	H	H	H	H	H	-CH ₃
211	2-naphtyl	H	H	H	H	H	-CH ₃
212	o-biphenyl	H	H	H	H	H	-CH ₃
213	m-biphenyl	H	H	H	H	H	-CH ₃
214	p-biphenyl	H	H	H	H	H	-CH ₃
215	o-tolyl	H	H	H	H	H	-CH ₃
216	m-tolyl	H	H	H	H	H	-CH ₃
217	p-tolyl	H	H	H	H	H	-CH ₃
218	Ph	H	H	H	H	-CH ₃	-CH ₃
219	1-naphtyl	H	H	H	H	-CH ₃	-CH ₃
220	2-naphtyl	H	H	H	H	-CH ₃	-CH ₃
221	o-biphenyl	H	H	H	H	-CH ₃	-CH ₃
222	m-biphenyl	H	H	H	H	-CH ₃	-CH ₃
223	p-biphenyl	H	H	H	H	-CH ₃	-CH ₃
224	o-tolyl	H	H	H	H	-CH ₃	-CH ₃
225	m-tolyl	H	H	H	H	-CH ₃	-CH ₃
226	p-tolyl	H	H	H	H	-CH ₃	-CH ₃
227	Ph	H	H	H	H	H	DPA
228	1-naphtyl	H	H	H	H	H	DPA
229	2-naphtyl	H	H	H	H	H	DPA
230	o-biphenyl	H	H	H	H	H	DPA
231	m-biphenyl	H	H	H	H	H	DPA
232	p-biphenyl	H	H	H	H	H	DPA
233	Ph	H	H	H	H	DPA	H
234	1-naphtyl	H	H	H	H	DPA	H
235	2-naphtyl	H	H	H	H	DPA	H
236	o-biphenyl	H	H	H	H	DPA	H
237	m-biphenyl	H	H	H	H	DPA	H
238	p-biphenyl	H	H	H	H	DPA	H
239	Ph	H	H	H	H	H	TPA
240	1-naphtyl	H	H	H	H	H	TPA
241	2-naphtyl	H	H	H	H	H	TPA
242	o-biphenyl	H	H	H	H	H	TPA
243	m-biphenyl	H	H	H	H	H	TPA
244	p-biphenyl	H	H	H	H	H	TPA
245	Ph	H	H	H	H	TPA	H
246	1-naphtyl	H	H	H	H	TPA	H
247	2-naphtyl	H	H	H	H	TPA	H
248	o-biphenyl	H	H	H	H	TPA	H
249	m-biphenyl	H	H	H	H	TPA	H
250	p-biphenyl	H	H	H	H	TPA	H

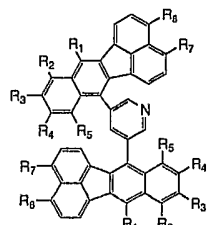

TypeNNN

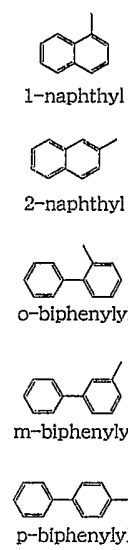

	R ₁	R ₂	R ₃	R ₄	R ₅	R ₇	R ₈
1	H	H	H	H	H	H	H
2	Ph	H	H	H	H	H	H
3	Ph	Ph	H	H	Ph	H	H
4	Ph	H	Ph	Ph	H	H	H
5	Ph	H	Ph	H	H	H	H
6	Ph	H	H	Ph	H	H	H
7	Ph	H	H	H	H	Ph	H
8	Ph	H	H	H	H	H	Ph
9	Ph	H	H	H	H	Ph	Ph
10	Ph	H	H	H	H	1-naphthyl	H
11	Ph	H	H	H	H	H	1-naphthyl
12	Ph	H	H	H	H	1-naphthyl	1-naphthyl
13	Ph	H	H	H	H	2-naphthyl	H
14	Ph	H	H	H	H	H	2-naphthyl
15	Ph	H	H	H	H	2-naphthyl	2-naphthyl
16	Ph	H	H	H	H	o-biphenyl	H
17	Ph	H	H	H	H	H	o-biphenyl
18	Ph	H	H	H	H	o-biphenyl	o-biphenyl
19	Ph	H	H	H	H	m-biphenyl	H
20	Ph	H	H	H	H	H	m-biphenyl
21	Ph	H	H	H	H	m-biphenyl	m-biphenyl
22	Ph	H	H	H	H	p-biphenyl	H
23	Ph	H	H	H	H	H	p-biphenyl
24	Ph	H	H	H	H	p-biphenyl	p-biphenyl
25	1-naphthyl	H	H	H	H	H	H
26	1-naphthyl	Ph	H	H	Ph	H	H
27	1-naphthyl	H	Ph	Ph	H	H	H
28	1-naphthyl	H	Ph	H	H	H	H
29	1-naphthyl	H	H	Ph	H	H	H
30	1-naphthyl	H	H	H	H	Ph	H
31	1-naphthyl	H	H	H	H	H	Ph
32	1-naphthyl	H	H	H	H	Ph	Ph
33	1-naphthyl	H	H	H	H	1-naphthyl	H
34	1-naphthyl	H	H	H	H	H	1-naphthyl
35	1-naphthyl	H	H	H	H	1-naphthyl	1-naphthyl
36	1-naphthyl	H	H	H	H	2-naphthyl	H
37	1-naphthyl	H	H	H	H	H	2-naphthyl
38	1-naphthyl	H	H	H	H	2-naphthyl	2-naphthyl
39	1-naphthyl	H	H	H	H	o-biphenyl	H
40	1-naphthyl	H	H	H	H	H	o-biphenyl
41	1-naphthyl	H	H	H	H	o-biphenyl	o-biphenyl
42	1-naphthyl	H	H	H	H	m-biphenyl	H
43	1-naphthyl	H	H	H	H	H	m-biphenyl
44	1-naphthyl	H	H	H	H	m-biphenyl	m-biphenyl
45	1-naphthyl	H	H	H	H	p-biphenyl	H
46	1-naphthyl	H	H	H	H	H	p-biphenyl
47	1-naphthyl	H	H	H	H	p-biphenyl	p-biphenyl

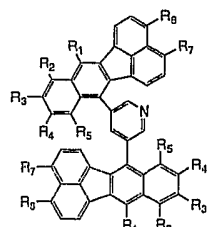

TypeNNN

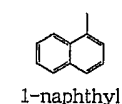

1-naphthyl

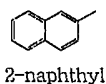

2-naphthyl

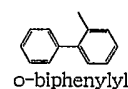

o-biphenyl

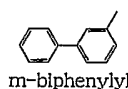

m-biphenyl

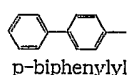

p-biphenyl

	R ₁	R ₂	R ₃	R ₄	R ₅	R ₇	R ₈
48	2-naphthyl	H	H	H	H	H	H
49	2-naphthyl	Ph	H	H	Ph	H	H
50	2-naphthyl	H	Ph	Ph	H	H	H
51	2-naphthyl	H	Ph	H	H	H	H
52	2-naphthyl	H	H	Ph	H	H	H
53	2-naphthyl	H	H	H	H	Ph	H
54	2-naphthyl	H	H	H	H	H	Ph
55	2-naphthyl	H	H	H	H	Ph	Ph
56	2-naphthyl	H	H	H	H	1-naphthyl	H
57	2-naphthyl	H	H	H	H	H	1-naphthyl
58	2-naphthyl	H	H	H	H	1-naphthyl	1-naphthyl
59	2-naphthyl	H	H	H	H	2-naphthyl	H
60	2-naphthyl	H	H	H	H	H	2-naphthyl
61	2-naphthyl	H	H	H	H	2-naphthyl	2-naphthyl
62	2-naphthyl	H	H	H	H	o-biphenyl	H
63	2-naphthyl	H	H	H	H	H	o-biphenyl
64	2-naphthyl	H	H	H	H	o-biphenyl	o-biphenyl
65	2-naphthyl	H	H	H	H	m-biphenyl	H
66	2-naphthyl	H	H	H	H	H	m-biphenyl
67	2-naphthyl	H	H	H	H	m-biphenyl	m-biphenyl
68	2-naphthyl	H	H	H	H	p-biphenyl	H
69	2-naphthyl	H	H	H	H	H	p-biphenyl
70	2-naphthyl	H	H	H	H	p-biphenyl	p-biphenyl
71	o-biphenyl	H	H	H	H	H	H
72	o-biphenyl	Ph	H	H	Ph	H	H
73	o-biphenyl	H	Ph	Ph	H	H	H
74	o-biphenyl	H	Ph	H	H	H	H
75	o-biphenyl	H	H	Ph	H	H	H
76	o-biphenyl	H	H	H	H	Ph	H
77	o-biphenyl	H	H	H	H	H	Ph
78	o-biphenyl	H	H	H	H	Ph	Ph
79	o-biphenyl	H	H	H	H	1-naphthyl	H
80	o-biphenyl	H	H	H	H	H	1-naphthyl
81	o-biphenyl	H	H	H	H	1-naphthyl	1-naphthyl
82	o-biphenyl	H	H	H	H	2-naphthyl	H
83	o-biphenyl	H	H	H	H	H	2-naphthyl
84	o-biphenyl	H	H	H	H	2-naphthyl	2-naphthyl
85	o-biphenyl	H	H	H	H	o-biphenyl	H
86	o-biphenyl	H	H	H	H	H	o-biphenyl
87	o-biphenyl	H	H	H	H	o-biphenyl	o-biphenyl
88	o-biphenyl	H	H	H	H	m-biphenyl	H
89	o-biphenyl	H	H	H	H	H	m-biphenyl
90	o-biphenyl	H	H	H	H	m-biphenyl	m-biphenyl
91	o-biphenyl	H	H	H	H	p-biphenyl	H
92	o-biphenyl	H	H	H	H	H	p-biphenyl
93	o-biphenyl	H	H	H	H	p-biphenyl	p-biphenyl

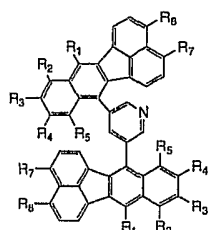

TypeNNN



1-naphthyl



2-naphthyl

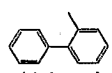

o-biphenylyl

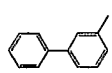

m-biphenylyl

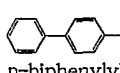

p-biphenylyl

	R ₁	R ₂	R ₃	R ₄	R ₅	R ₇	R ₈
94	m-biphenylyl	H	H	H	H	H	H
95	m-biphenylyl	Ph	H	H	Ph	H	H
96	m-biphenylyl	H	Ph	Ph	H	H	H
97	m-biphenylyl	H	Ph	H	H	H	H
98	m-biphenylyl	H	H	Ph	H	H	H
99	m-biphenylyl	H	H	H	H	Ph	H
100	m-biphenylyl	H	H	H	H	H	Ph
101	m-biphenylyl	H	H	H	H	Ph	Ph
102	m-biphenylyl	H	H	H	H	1-naphthyl	H
103	m-biphenylyl	H	H	H	H	H	1-naphthyl
104	m-biphenylyl	H	H	H	H	1-naphthyl	1-naphthyl
105	m-biphenylyl	H	H	H	H	2-naphthyl	H
106	m-biphenylyl	H	H	H	H	H	2-naphthyl
107	m-biphenylyl	H	H	H	H	2-naphthyl	2-naphthyl
108	m-biphenylyl	H	H	H	H	o-biphenylyl	H
109	m-biphenylyl	H	H	H	H	H	o-biphenylyl
110	m-biphenylyl	H	H	H	H	o-biphenylyl	o-biphenylyl
111	m-biphenylyl	H	H	H	H	m-biphenylyl	H
112	m-biphenylyl	H	H	H	H	H	m-biphenylyl
113	m-biphenylyl	H	H	H	H	m-biphenylyl	m-biphenylyl
114	m-biphenylyl	H	H	H	H	p-biphenylyl	H
115	m-biphenylyl	H	H	H	H	H	p-biphenylyl
116	m-biphenylyl	H	H	H	H	p-biphenylyl	p-biphenylyl
117	p-biphenylyl	H	H	H	H	H	H
118	p-biphenylyl	Ph	H	H	Ph	H	H
119	p-biphenylyl	H	Ph	Ph	H	H	H
120	p-biphenylyl	H	Ph	H	H	H	H
121	p-biphenylyl	H	H	Ph	H	H	H
122	p-biphenylyl	H	H	H	H	Ph	H
123	p-biphenylyl	H	H	H	H	H	Ph
124	p-biphenylyl	H	H	H	H	Ph	Ph
125	p-biphenylyl	H	H	H	H	1-naphthyl	H
126	p-biphenylyl	H	H	H	H	H	1-naphthyl
127	p-biphenylyl	H	H	H	H	1-naphthyl	1-naphthyl
128	p-biphenylyl	H	H	H	H	2-naphthyl	H
129	p-biphenylyl	H	H	H	H	H	2-naphthyl
130	p-biphenylyl	H	H	H	H	2-naphthyl	2-naphthyl
131	p-biphenylyl	H	H	H	H	o-biphenylyl	H
132	p-biphenylyl	H	H	H	H	H	o-biphenylyl
133	p-biphenylyl	H	H	H	H	o-biphenylyl	o-biphenylyl
134	p-biphenylyl	H	H	H	H	m-biphenylyl	H
135	p-biphenylyl	H	H	H	H	H	m-biphenylyl
136	p-biphenylyl	H	H	H	H	m-biphenylyl	m-biphenylyl
137	p-biphenylyl	H	H	H	H	p-biphenylyl	H
138	p-biphenylyl	H	H	H	H	H	p-biphenylyl
139	p-biphenylyl	H	H	H	H	p-biphenylyl	p-biphenylyl

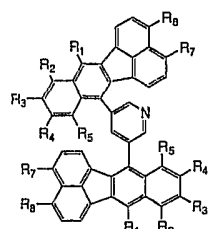

TypeNNN

	R ₁	R ₂	R ₃	R ₄	R ₅	R ₇	R ₈
140	o-tolyl	H	H	H	H	H	H
141	o-tolyl	Ph	H	H	Ph	H	H
142	o-tolyl	H	Ph	Ph	H	H	H
143	o-tolyl	H	H	H	H	Ph	H
144	o-tolyl	H	H	H	H	H	Ph
145	o-tolyl	H	H	H	H	1-naphthyl	H
146	o-tolyl	H	H	H	H	H	1-naphthyl
147	o-tolyl	H	H	H	H	2-naphthyl	H
148	o-tolyl	H	H	H	H	H	2-naphthyl
149	o-tolyl	H	H	H	H	o-biphenyl	H
150	o-tolyl	H	H	H	H	H	o-biphenyl
151	o-tolyl	H	H	H	H	m-biphenyl	H
152	o-tolyl	H	H	H	H	H	m-biphenyl
153	o-tolyl	H	H	H	H	p-biphenyl	H
154	o-tolyl	H	H	H	H	H	p-biphenyl
155	o-tolyl	H	H	H	H	o-tolyl	H
156	o-tolyl	H	H	H	H	H	o-tolyl
157	m-tolyl	H	H	H	H	H	H
158	m-tolyl	Ph	H	H	Ph	H	H
159	m-tolyl	H	Ph	Ph	H	H	H
160	m-tolyl	H	H	H	H	Ph	H
161	m-tolyl	H	H	H	H	H	Ph
162	m-tolyl	H	H	H	H	1-naphthyl	H
163	m-tolyl	H	H	H	H	H	1-naphthyl
164	m-tolyl	H	H	H	H	2-naphthyl	H
165	m-tolyl	H	H	H	H	H	2-naphthyl
166	m-tolyl	H	H	H	H	o-biphenyl	H
167	m-tolyl	H	H	H	H	H	o-biphenyl
168	m-tolyl	H	H	H	H	m-biphenyl	H
169	m-tolyl	H	H	H	H	H	m-biphenyl
170	m-tolyl	H	H	H	H	p-biphenyl	H
171	m-tolyl	H	H	H	H	H	p-biphenyl
172	m-tolyl	H	H	H	H	m-tolyl	H
173	m-tolyl	H	H	H	H	H	m-tolyl
174	p-tolyl	H	H	H	H	H	H
175	p-tolyl	Ph	H	H	Ph	H	H
176	p-tolyl	H	Ph	Ph	H	H	H
177	p-tolyl	H	H	H	H	Ph	H
178	p-tolyl	H	H	H	H	H	Ph
179	p-tolyl	H	H	H	H	1-naphthyl	H
180	p-tolyl	H	H	H	H	H	1-naphthyl
181	p-tolyl	H	H	H	H	2-naphthyl	H
182	p-tolyl	H	H	H	H	H	2-naphthyl
183	p-tolyl	H	H	H	H	o-biphenyl	H
184	p-tolyl	H	H	H	H	H	o-biphenyl
185	p-tolyl	H	H	H	H	m-biphenyl	H
186	p-tolyl	H	H	H	H	H	m-biphenyl
187	p-tolyl	H	H	H	H	p-biphenyl	H
188	p-tolyl	H	H	H	H	H	p-biphenyl
189	p-tolyl	H	H	H	H	p-tolyl	H
190	p-tolyl	H	H	H	H	H	p-tolyl

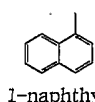

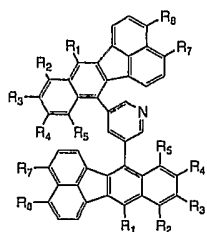

TypeNNN

	R ₁	R ₂	R ₃	R ₄	R ₅	R ₇	R ₈
191	Ph	H	-CH ₃	-CH ₃	H	H	H
192	1-naphthyl	H	-CH ₃	-CH ₃	H	H	H
193	2-naphthyl	H	-CH ₃	-CH ₃	H	H	H
194	o-biphenylyl	H	-CH ₃	-CH ₃	H	H	H
195	m-biphenylyl	H	-CH ₃	-CH ₃	H	H	H
196	p-biphenylyl	H	-CH ₃	-CH ₃	H	H	H
197	o-tolyl	H	-CH ₃	-CH ₃	H	H	H
198	m-tolyl	H	-CH ₃	-CH ₃	H	H	H
199	p-tolyl	H	-CH ₃	-CH ₃	H	H	H
200	Ph	H	H	H	H	-CH ₃	H
201	1-naphthyl	H	H	H	H	-CH ₃	H
202	2-naphthyl	H	H	H	H	-CH ₃	H
203	o-biphenylyl	H	H	H	H	-CH ₃	H
204	m-biphenylyl	H	H	H	H	-CH ₃	H
205	p-biphenylyl	H	H	H	H	-CH ₃	H
206	o-tolyl	H	H	H	H	-CH ₃	H
207	m-tolyl	H	H	H	H	-CH ₃	H
208	p-tolyl	H	H	H	H	-CH ₃	H
209	Ph	H	H	H	H	H	-CH ₃
210	1-naphthyl	H	H	H	H	H	-CH ₃
211	2-naphthyl	H	H	H	H	H	-CH ₃
212	o-biphenylyl	H	H	H	H	H	-CH ₃
213	m-biphenylyl	H	H	H	H	H	-CH ₃
214	p-biphenylyl	H	H	H	H	H	-CH ₃
215	o-tolyl	H	H	H	H	H	-CH ₃
216	m-tolyl	H	H	H	H	H	-CH ₃
217	p-tolyl	H	H	H	H	H	-CH ₃
218	Ph	H	H	H	H	-CH ₃	-CH ₃
219	1-naphthyl	H	H	H	H	-CH ₃	-CH ₃
220	2-naphthyl	H	H	H	H	-CH ₃	-CH ₃
221	o-biphenylyl	H	H	H	H	-CH ₃	-CH ₃
222	m-biphenylyl	H	H	H	H	-CH ₃	-CH ₃
223	p-biphenylyl	H	H	H	H	-CH ₃	-CH ₃
224	o-tolyl	H	H	H	H	-CH ₃	-CH ₃
225	m-tolyl	H	H	H	H	-CH ₃	-CH ₃
226	p-tolyl	H	H	H	H	-CH ₃	-CH ₃
227	Ph	H	H	H	H	H	DPA
228	1-naphthyl	H	H	H	H	H	DPA
229	2-naphthyl	H	H	H	H	H	DPA
230	o-biphenylyl	H	H	H	H	H	DPA
231	m-biphenylyl	H	H	H	H	H	DPA
232	p-biphenylyl	H	H	H	H	H	DPA
233	Ph	H	H	H	H	DPA	H
234	1-naphthyl	H	H	H	H	DPA	H
235	2-naphthyl	H	H	H	H	DPA	H
236	o-biphenylyl	H	H	H	H	DPA	H
237	m-biphenylyl	H	H	H	H	DPA	H
238	p-biphenylyl	H	H	H	H	DPA	H
239	Ph	H	H	H	H	H	TPA
240	1-naphthyl	H	H	H	H	H	TPA
241	2-naphthyl	H	H	H	H	H	TPA
242	o-biphenylyl	H	H	H	H	H	TPA
243	m-biphenylyl	H	H	H	H	H	TPA
244	p-biphenylyl	H	H	H	H	H	TPA
245	Ph	H	H	H	H	TPA	H
246	1-naphthyl	H	H	H	H	TPA	H
247	2-naphthyl	H	H	H	H	TPA	H
248	o-biphenylyl	H	H	H	H	TPA	H
249	m-biphenylyl	H	H	H	H	TPA	H
250	p-biphenylyl	H	H	H	H	TPA	H

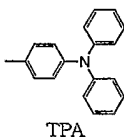
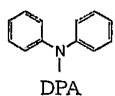
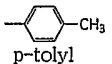
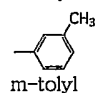
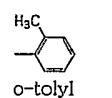
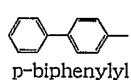
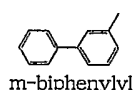
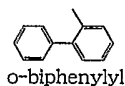
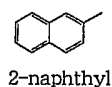
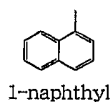

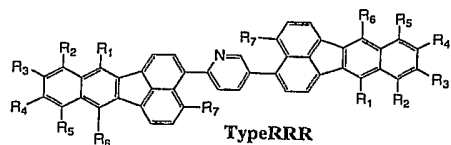

	R ₁	R ₂	R ₃	R ₄	R ₅	R ₆	R ₇
1	H	H	H	H	H	H	H
2	Ph	H	H	H	H	Ph	H
3	Ph	Ph	H	H	Ph	Ph	H
4	Ph	H	Ph	Ph	H	Ph	H
5	Ph	H	Ph	H	H	Ph	H
6	Ph	H	H	H	H	Ph	Ph
7	Ph	Me	H	H	Me	Ph	H
8	Ph	H	Me	Me	H	Ph	H
9	Ph	H	H	H	H	Ph	Me
10		H	H	H	H		H
11		Ph	H	H	Ph		H
12		H	Ph	Ph	H		H
13		H	Ph	H	H		H
14		H	H	H	H		Ph
15		Me	H	H	Me		H
16		H	Me	Me	H		H
17		H	H	H	H		Me
18		H	H	H	H		H
19		Ph	H	H	Ph		H
20		H	Ph	Ph	H		H
21		H	Ph	H	H		H
22		H	H	H	H		Ph
23		Me	H	H	Me		H
24		H	Me	Me	H		H
25		H	H	H	H		Me

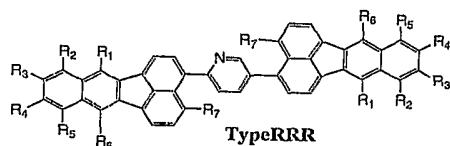

	R ₁	R ₂	R ₃	R ₄	R ₅	R ₆	R ₇
26		H	H	H	H		H
27		Ph	H	H	Ph		H
28		H	Ph	Ph	H		H
29		H	Ph	H	H		H
30		H	H	H	H		Ph
31		Me	H	H	Me		H
32		H	Me	Me	H		H
33		H	H	H	H		Me
34		H	H	H	H		H
35		Ph	H	H	Ph		H
36		H	Ph	Ph	H		H
37		H	Ph	H	H		H
38		H	H	H	H		Ph
39		Me	H	H	Me		H
40		H	Me	Me	H		H
41		H	H	H	H		Me
42		H	H	H	H		H
43		Ph	H	H	Ph		H
44		H	Ph	Ph	H		H
45		H	Ph	H	H		H
46		H	H	H	H		Ph
47		Me	H	H	Me		H
48		H	Me	Me	H		H
49		H	H	H	H		Me

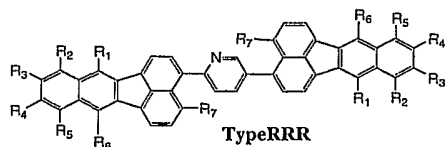

	R ₁	R ₂	R ₃	R ₄	R ₅	R ₆	R ₇
50	Ph	H	H	H	H		H
51	Ph	H	H	H	H		H
52	Ph	H	H	H	H		H
53	Ph	H	H	H	H		H
54	Ph	H	H	H	H		H
55		H	H	H	H		H
56		H	H	H	H		H
57		H	H	H	H		H
58		H	H	H	H		H
59		H	H	H	H		H
60		H	H	H	H		H
61		H	H	H	H		H
62		H	H	H	H		H
63		H	H	H	H		H
64		H	H	H	H		H
65	H	Ph	H	H	Ph	H	H
66	H		H	H		H	H
67	H		H	H		H	H
68	H		H	H		H	H
69	H		H	H		H	H
70	H		H	H		H	H
71	H	H			H	H	H
72	H	H			H	H	H
73	H	H			H	H	H
74	H	H			H	H	H
75	H	H			H	H	H

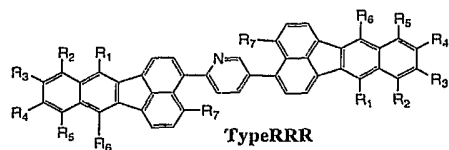

	R ₁	R ₂	R ₃	R ₄	R ₅	R ₆	R ₇
76		H	H	H	H		H
77		Ph	H	H	Ph		H
78		H	Ph	Ph	H		H
79		H	Ph	H	H		H
80		H	H	H	H		Ph
81		Me	H	H	Me		H
82		H	Me	Me	H		H
83		H	H	H	H		Me
84		H	H	H	H		H
85		Ph	H	H	Ph		H
86		H	Ph	Ph	H		H
87		H	Ph	H	H		H
88		H	H	H	H		Ph
89		Me	H	H	Me		H
90		H	Me	Me	H		H
91		H	H	H	H		Me
92		H	H	H	H		H
93		Ph	H	H	Ph		H
94		H	Ph	Ph	H		H
96		H	Ph	H	H		H
96		H	H	H	H		Ph
97		Me	H	H	Me		H
98		H	Me	Me	H		H
99		H	H	H	H		Me

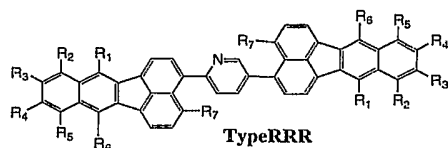



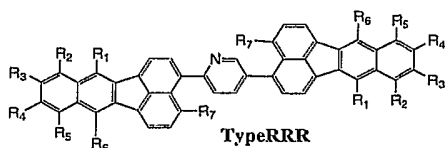



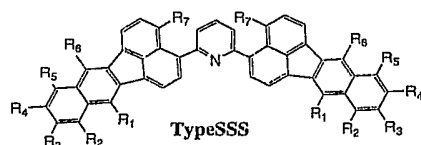

























	R ₁	R ₂	R ₃	R ₄	R ₅	R ₆	R ₇
100		H	H	H	H		H
101		Ph	H	H	Ph		H
102		H	Ph	Ph	H		H
103		H	Ph	H	H		H
104		H	H	H	H		Ph
105		Me	H	H	Me		H
106		H	Me	Me	H		H
107		H	H	H	H		Me
108		H	H	H	H		H
109		Ph	H	H	Ph		H
110		H	Ph	Ph	H		H
111		H	Ph	H	H		H
112		H	H	H	H		Ph
113		Me	H	H	Me		H
114		H	Me	Me	H		H
115		H	H	H	H		Me
116		H	H	H	H		H
117		Ph	H	H	Ph		H
118		H	Ph	Ph	H		H
119		H	Ph	H	H		H
120		H	H	H	H		Ph
121		Me	H	H	Me		H
122		H	Me	Me	H		H
123		H	H	H	H		Me



	R ₁	R ₂	R ₃	R ₄	R ₅	R ₆	R ₇
124		H	H	H	H		H
125		Ph	H	H	Ph		H
126		H	Ph	Ph	H		H
127		H	Ph	H	H		H
128		H	H	H	H		Ph
129		Me	H	H	Me		H
130		H	Me	Me	H		H
131		H	H	H	H		Me
132		H	H	H	H		H
133		Ph	H	H	Ph		H
134		H	Ph	Ph	H		H
135		H	Ph	H	H		H
136		H	H	H	H		Ph
137		Me	H	H	Me		H
138		H	Me	Me	H		H
139		H	H	H	H		Me
140		H	H	H	H		H
141		Ph	H	H	Ph		H
142		H	Ph	Ph	H		H
143		H	Ph	H	H		H
144		H	H	H	H		Ph
145		Me	H	H	Me		H
146		H	Me	Me	H		H
147		H	H	H	H		Me



	R ₁	R ₂	R ₃	R ₄	R ₅	R ₆	R ₇
1	H	H	H	H	H	H	H
2	Ph	H	H	H	H	Ph	H
3	Ph	Ph	H	H	Ph	Ph	H
4	Ph	H	Ph	Ph	H	Ph	H
5	Ph	H	Ph	H	H	Ph	H
6	Ph	H	H	H	H	Ph	Ph
7	Ph	Me	H	H	Me	Ph	H
8	Ph	H	Me	Me	H	Ph	H
9	Ph	H	H	H	H	Ph	Me
10		H	H	H	H		H
11		Ph	H	H	Ph		H
12		H	Ph	Ph	H		H
13		H	Ph	H	H		H
14		H	H	H	H		Ph
15		Me	H	H	Me		H
16		H	Me	Me	H		H
17		H	H	H	H		Me
18		H	H	H	H		H
19		Ph	H	H	Ph		H
20		H	Ph	Ph	H		H
21		H	Ph	H	H		H
22		H	H	H	H		Ph
23		Me	H	H	Me		H
24		H	Me	Me	H		H
25		H	H	H	H		Me

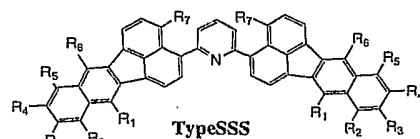

	R ₁	R ₂	R ₃	R ₄	R ₅	R ₆	R ₇
26		H	H	H	H		H
27		Ph	H	H	Ph		H
28		H	Ph	Ph	H		H
29		H	Ph	H	H		H
30		H	H	H	H		Ph
31		Me	H	H	Me		H
32		H	Me	Me	H		H
33		H	H	H	H		Me
34		H	H	H	H		H
35		Ph	H	H	Ph		H
36		H	Ph	Ph	H		H
37		H	Ph	H	H		H
38		H	H	H	H		Ph
39		Me	H	H	Me		H
40		H	Me	Me	H		H
41		H	H	H	H		Me
42		H	H	H	H		H
43		Ph	H	H	Ph		H
44		H	Ph	Ph	H		H
45		H	Ph	H	H		H
46		H	H	H	H		Ph
47		Me	H	H	Me		H
48		H	Me	Me	H		H
49		H	H	H	H		Me

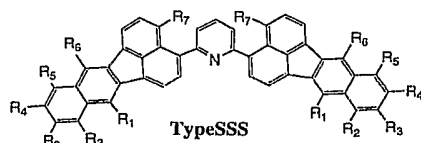

	R ₁	R ₂	R ₃	R ₄	R ₅	R ₆	R ₇
50	Ph	H	H	H	H		H
51	Ph	H	H	H	H		H
52	Ph	H	H	H	H		H
53	Ph	H	H	H	H		H
54	Ph	H	H	H	H		H
55		H	H	H	H		H
56		H	H	H	H		H
57		H	H	H	H		H
58		H	H	H	H		H
59		H	H	H	H		H
60		H	H	H	H		H
61		H	H	H	H		H
62		H	H	H	H		H
63		H	H	H	H		H
64		H	H	H	H		H
65	H	Ph	H	H	Ph	H	H
66	H		H	H		H	H
67	H		H	H		H	H
68	H		H	H		H	H
69	H		H	H		H	H
70	H		H	H		H	H
71	H	H			H	H	H
72	H	H			H	H	H
73	H	H			H	H	H
74	H	H			H	H	H
75	H	H			H	H	H

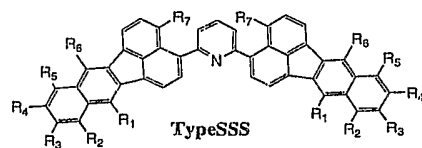

	R ₁	R ₂	R ₃	R ₄	R ₅	R ₆	R ₇
76		H	H	H	H		H
77		Ph	H	H	Ph		H
78		H	Ph	Ph	H		H
79		H	Ph	H	H		H
80		H	H	H	H		Ph
81		Me	H	H	Me		H
82		H	Me	Me	H		H
83		H	H	H	H		Me
84		H	H	H	H		H
85		Ph	H	H	Ph		H
86		H	Ph	Ph	H		H
87		H	Ph	H	H		H
88		H	H	H	H		Ph
89		Me	H	H	Me		H
90		H	Me	Me	H		H
91		H	H	H	H		Me
92		H	H	H	H		H
93		Ph	H	H	Ph		H
94		H	Ph	Ph	H		H
96		H	Ph	H	H		H
96		H	H	H	H		Ph
97		Me	H	H	Me		H
98		H	Me	Me	H		H
99		H	H	H	H		Me

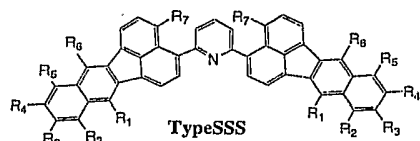

	R ₁	R ₂	R ₃	R ₄	R ₅	R ₆	R ₇
100		H	H	H	H		H
101		Ph	H	H	Ph		H
102		H	Ph	Ph	H		H
103		H	Ph	H	H		H
104		H	H	H	H		Ph
105		Me	H	H	Me		H
106		H	Me	Me	H		H
107		H	H	H	H		Me
108		H	H	H	H		H
109		Ph	H	H	Ph		H
110		H	Ph	Ph	H		H
111		H	Ph	H	H		H
112		H	H	H	H		Ph
113		Me	H	H	Me		H
114		H	Me	Me	H		H
115		H	H	H	H		Me
116		H	H	H	H		H
117		Ph	H	H	Ph		H
118		H	Ph	Ph	H		H
119		H	Ph	H	H		H
120		H	H	H	H		Ph
121		Me	H	H	Me		H
122		H	Me	Me	H		H
123		H	H	H	H		Me

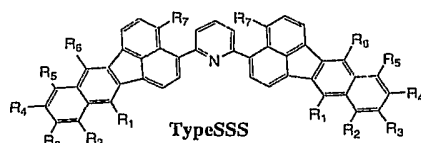

	R ₁	R ₂	R ₃	R ₄	R ₅	R ₆	R ₇
124		H	H	H	H		H
125		Ph	H	H	Ph		H
126		H	Ph	Ph	H		H
127		H	Ph	H	H		H
128		H	H	H	H		Ph
129		Me	H	H	Me		H
130		H	Me	Me	H		H
131		H	H	H	H		Me
132		H	H	H	H		H
133		Ph	H	H	Ph		H
134		H	Ph	Ph	H		H
135		H	Ph	H	H		H
136		H	H	H	H		Ph
137		Me	H	H	Me		H
138		H	Me	Me	H		H
139		H	H	H	H		Me
140		H	H	H	H		H
141		Ph	H	H	Ph		H
142		H	Ph	Ph	H		H
143		H	Ph	H	H		H
144		H	H	H	H		Ph
145		Me	H	H	Me		H
146		H	Me	Me	H		H
147		H	H	H	H		Me

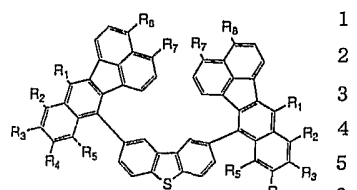

TypeTTT

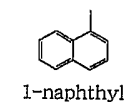

1-naphthyl



2-naphthyl

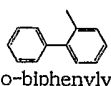

o-biphenylyl

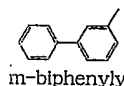

m-biphenylyl

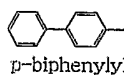

p-biphenylyl



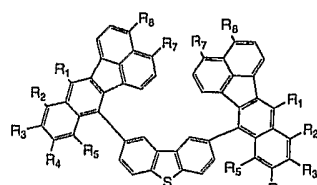

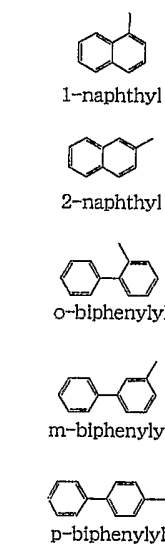

	R ₁	R ₂	R ₃	R ₄	R ₅	R ₇	R ₈
1	H	H	H	H	H	H	H
2	Ph	H	H	H	H	H	H
3	Ph	Ph	H	H	Ph	H	H
4	Ph	H	Ph	Ph	H	H	H
5	Ph	H	Ph	H	H	H	H
6	Ph	H	H	Ph	H	H	H
7	Ph	H	H	H	H	Ph	H
8	Ph	H	H	H	H	H	Ph
9	Ph	H	H	H	H	Ph	Ph
10	Ph	H	H	H	H	1-naphthyl	H
11	Ph	H	H	H	H	H	1-naphthyl
12	Ph	H	H	H	H	1-naphthyl	1-naphthyl
13	Ph	H	H	H	H	2-naphthyl	H
14	Ph	H	H	H	H	H	2-naphthyl
15	Ph	H	H	H	H	2-naphthyl	2-naphthyl
16	Ph	H	H	H	H	o-biphenylyl	H
17	Ph	H	H	H	H	H	o-biphenylyl
18	Ph	H	H	H	H	o-biphenylyl	o-biphenylyl
19	Ph	H	H	H	H	m-biphenylyl	H
20	Ph	H	H	H	H	H	m-biphenylyl
21	Ph	H	H	H	H	m-biphenylyl	m-biphenylyl
22	Ph	H	H	H	H	p-biphenylyl	H
23	Ph	H	H	H	H	H	p-biphenylyl
24	Ph	H	H	H	H	p-biphenylyl	p-biphenylyl
25	1-naphthyl	H	H	H	H	H	H
26	1-naphthyl	Ph	H	H	Ph	H	H
27	1-naphthyl	H	Ph	Ph	H	H	H
28	1-naphthyl	H	Ph	H	H	H	H
29	1-naphthyl	H	H	Ph	H	H	H
30	1-naphthyl	H	H	H	H	Ph	H
31	1-naphthyl	H	H	H	H	H	Ph
32	1-naphthyl	H	H	H	H	Ph	Ph
33	1-naphthyl	H	H	H	H	1-naphthyl	H
34	1-naphthyl	H	H	H	H	H	1-naphthyl
35	1-naphthyl	H	H	H	H	1-naphthyl	1-naphthyl
36	1-naphthyl	H	H	H	H	2-naphthyl	H
37	1-naphthyl	H	H	H	H	H	2-naphthyl
38	1-naphthyl	H	H	H	H	2-naphthyl	2-naphthyl
39	1-naphthyl	H	H	H	H	o-biphenylyl	H
40	1-naphthyl	H	H	H	H	H	o-biphenylyl
41	1-naphthyl	H	H	H	H	o-biphenylyl	o-biphenylyl
42	1-naphthyl	H	H	H	H	m-biphenylyl	H
43	1-naphthyl	H	H	H	H	H	m-biphenylyl
44	1-naphthyl	H	H	H	H	m-biphenylyl	m-biphenylyl
45	1-naphthyl	H	H	H	H	p-biphenylyl	H
46	1-naphthyl	H	H	H	H	H	p-biphenylyl
47	1-naphthyl	H	H	H	H	p-biphenylyl	p-biphenylyl

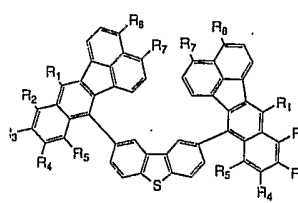

TypeTTT



	R ₁	R ₂	R ₃	R ₄	R ₅	R ₇	R ₈
48	2-naphthyl	H	H	H	H	H	H
49	2-naphthyl	Ph	H	H	Ph	H	H
50	2-naphthyl	H	Ph	Ph	H	H	H
51	2-naphthyl	H	Ph	H	H	H	H
52	2-naphthyl	H	H	Ph	H	H	H
53	2-naphthyl	H	H	H	H	Ph	H
54	2-naphthyl	H	H	H	H	H	Ph
55	2-naphthyl	H	H	H	H	Ph	Ph
56	2-naphthyl	H	H	H	H	1-naphthyl	H
57	2-naphthyl	H	H	H	H	H	1-naphthyl
58	2-naphthyl	H	H	H	H	1-naphthyl	1-naphthyl
59	2-naphthyl	H	H	H	H	2-naphthyl	H
60	2-naphthyl	H	H	H	H	H	2-naphthyl
61	2-naphthyl	H	H	H	H	2-naphthyl	2-naphthyl
62	2-naphthyl	H	H	H	H	o-biphenyl	H
63	2-naphthyl	H	H	H	H	H	o-biphenyl
64	2-naphthyl	H	H	H	H	o-biphenyl	o-biphenyl
65	2-naphthyl	H	H	H	H	m-biphenyl	H
66	2-naphthyl	H	H	H	H	H	m-biphenyl
67	2-naphthyl	H	H	H	H	m-biphenyl	m-biphenyl
68	2-naphthyl	H	H	H	H	p-biphenyl	H
69	2-naphthyl	H	H	H	H	H	p-biphenyl
70	2-naphthyl	H	H	H	H	p-biphenyl	p-biphenyl
71	o-biphenyl	H	H	H	H	H	H
72	o-biphenyl	Ph	H	H	Ph	H	H
73	o-biphenyl	H	Ph	Ph	H	H	H
74	o-biphenyl	H	Ph	H	H	H	H
75	o-biphenyl	H	H	Ph	H	H	H
76	o-biphenyl	H	H	H	H	Ph	H
77	o-biphenyl	H	H	H	H	H	Ph
78	o-biphenyl	H	H	H	H	Ph	Ph
79	o-biphenyl	H	H	H	H	1-naphthyl	H
80	o-biphenyl	H	H	H	H	H	1-naphthyl
81	o-biphenyl	H	H	H	H	1-naphthyl	1-naphthyl
82	o-biphenyl	H	H	H	H	2-naphthyl	H
83	o-biphenyl	H	H	H	H	H	2-naphthyl
84	o-biphenyl	H	H	H	H	2-naphthyl	2-naphthyl
85	o-biphenyl	H	H	H	H	o-biphenyl	H
86	o-biphenyl	H	H	H	H	H	o-biphenyl
87	o-biphenyl	H	H	H	H	o-biphenyl	o-biphenyl
88	o-biphenyl	H	H	H	H	m-biphenyl	H
89	o-biphenyl	H	H	H	H	H	m-biphenyl
90	o-biphenyl	H	H	H	H	m-biphenyl	m-biphenyl
91	o-biphenyl	H	H	H	H	p-biphenyl	H
92	o-biphenyl	H	H	H	H	H	p-biphenyl
93	o-biphenyl	H	H	H	H	p-biphenyl	p-biphenyl

	R ₁	R ₂	R ₃	R ₄	R ₅	R ₇	R ₈
	m-biphenylyl	H	H	H	H	H	H
	m-biphenylyl	Ph	H	H	Ph	H	H
	m-biphenylyl	H	Ph	Ph	H	H	H
	m-biphenylyl	H	Ph	H	H	H	H
	m-biphenylyl	H	H	Ph	H	H	H
	m-biphenylyl	H	H	H	H	Ph	H
TypeTTT	m-biphenylyl	H	H	H	H	H	Ph
	m-biphenylyl	H	H	H	H	Ph	Ph
	m-biphenylyl	H	H	H	H	1-naphthyl	H
	m-biphenylyl	H	H	H	H	H	1-naphthyl
1-naphthyl	m-biphenylyl	H	H	H	H	1-naphthyl	1-naphthyl
	m-biphenylyl	H	H	H	H	2-naphthyl	H
	m-biphenylyl	H	H	H	H	H	2-naphthyl
2-naphthyl	m-biphenylyl	H	H	H	H	2-naphthyl	2-naphthyl
	m-biphenylyl	H	H	H	H	o-biphenylyl	H
	m-biphenylyl	H	H	H	H	H	o-biphenylyl
o-biphenylyl	m-biphenylyl	H	H	H	H	o-biphenylyl	o-biphenylyl
	m-biphenylyl	H	H	H	H	m-biphenylyl	H
	m-biphenylyl	H	H	H	H	H	m-biphenylyl
m-biphenylyl	m-biphenylyl	H	H	H	H	m-biphenylyl	m-biphenylyl
	m-biphenylyl	H	H	H	H	p-biphenylyl	H
	m-biphenylyl	H	H	H	H	H	p-biphenylyl
p-biphenylyl	m-biphenylyl	H	H	H	H	p-biphenylyl	p-biphenylyl
	p-biphenylyl	H	H	H	H	H	H
	p-biphenylyl	Ph	H	H	Ph	H	H
	p-biphenylyl	H	Ph	Ph	H	H	H
	p-biphenylyl	H	Ph	H	H	H	H
	p-biphenylyl	H	H	Ph	H	H	H
	p-biphenylyl	H	H	H	H	Ph	H
	p-biphenylyl	H	H	H	H	H	Ph
	p-biphenylyl	H	H	H	H	Ph	Ph
	p-biphenylyl	H	H	H	H	1-naphthyl	H
	p-biphenylyl	H	H	H	H	H	1-naphthyl
	p-biphenylyl	H	H	H	H	1-naphthyl	1-naphthyl
	p-biphenylyl	H	H	H	H	2-naphthyl	H
	p-biphenylyl	H	H	H	H	H	2-naphthyl
	p-biphenylyl	H	H	H	H	2-naphthyl	2-naphthyl
	p-biphenylyl	H	H	H	H	o-biphenylyl	H
	p-biphenylyl	H	H	H	H	H	o-biphenylyl
	p-biphenylyl	H	H	H	H	o-biphenylyl	o-biphenylyl
	p-biphenylyl	H	H	H	H	m-biphenylyl	H
	p-biphenylyl	H	H	H	H	H	m-biphenylyl
	p-biphenylyl	H	H	H	H	m-biphenylyl	m-biphenylyl
	p-biphenylyl	H	H	H	H	p-biphenylyl	H
	p-biphenylyl	H	H	H	H	H	p-biphenylyl
	p-biphenylyl	H	H	H	H	p-biphenylyl	p-biphenylyl

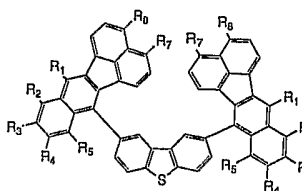
	R ₁	R ₂	R ₃	R ₄	R ₅	R ₇	R ₈	
 <p>Type TTT</p>	140	o-tolyl	H	H	H	H	H	
	141	o-tolyl	Ph	H	H	Ph	H	
	142	o-tolyl	H	Ph	Ph	H	H	
	143	o-tolyl	H	H	H	Ph	H	
	144	o-tolyl	H	H	H	H	Ph	
	145	o-tolyl	H	H	H	H	1-naphthyl	H
	146	o-tolyl	H	H	H	H	H	1-naphthyl
	147	o-tolyl	H	H	H	H	2-naphthyl	H
	148	o-tolyl	H	H	H	H	H	2-naphthyl
	149	o-tolyl	H	H	H	H	o-biphenyl	H
150	o-tolyl	H	H	H	H	H	o-biphenyl	
151	o-tolyl	H	H	H	H	m-biphenyl	H	
152	o-tolyl	H	H	H	H	H	m-biphenyl	
153	o-tolyl	H	H	H	H	p-biphenyl	H	
154	o-tolyl	H	H	H	H	H	p-biphenyl	
155	o-tolyl	H	H	H	H	o-tolyl	H	
156	o-tolyl	H	H	H	H	H	o-tolyl	
157	m-tolyl	H	H	H	H	H	H	
158	m-tolyl	Ph	H	H	Ph	H	H	
159	m-tolyl	H	Ph	Ph	H	H	H	
160	m-tolyl	H	H	H	H	Ph	H	
161	m-tolyl	H	H	H	H	H	Ph	
162	m-tolyl	H	H	H	H	1-naphthyl	H	
163	m-tolyl	H	H	H	H	H	1-naphthyl	
164	m-tolyl	H	H	H	H	2-naphthyl	H	
165	m-tolyl	H	H	H	H	H	2-naphthyl	
166	m-tolyl	H	H	H	H	o-biphenyl	H	
167	m-tolyl	H	H	H	H	H	o-biphenyl	
168	m-tolyl	H	H	H	H	m-biphenyl	H	
169	m-tolyl	H	H	H	H	H	m-biphenyl	
170	m-tolyl	H	H	H	H	p-biphenyl	H	
171	m-tolyl	H	H	H	H	H	p-biphenyl	
172	m-tolyl	H	H	H	H	m-tolyl	H	
173	m-tolyl	H	H	H	H	H	m-tolyl	
174	p-tolyl	H	H	H	H	H	H	
175	p-tolyl	Ph	H	H	Ph	H	H	
176	p-tolyl	H	Ph	Ph	H	H	H	
177	p-tolyl	H	H	H	H	Ph	H	
178	p-tolyl	H	H	H	H	H	Ph	
179	p-tolyl	H	H	H	H	1-naphthyl	H	
180	p-tolyl	H	H	H	H	H	1-naphthyl	
181	p-tolyl	H	H	H	H	2-naphthyl	H	
182	p-tolyl	H	H	H	H	H	2-naphthyl	
183	p-tolyl	H	H	H	H	o-biphenyl	H	
184	p-tolyl	H	H	H	H	H	o-biphenyl	
185	p-tolyl	H	H	H	H	m-biphenyl	H	
186	p-tolyl	H	H	H	H	H	m-biphenyl	
187	p-tolyl	H	H	H	H	p-biphenyl	H	
188	p-tolyl	H	H	H	H	H	p-biphenyl	
189	p-tolyl	H	H	H	H	p-tolyl	H	
190	p-tolyl	H	H	H	H	H	p-tolyl	

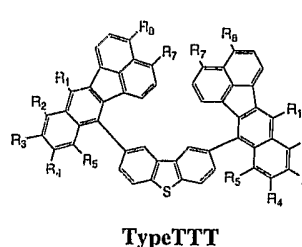

	R ₁	R ₂	R ₃	R ₄	R ₅	R ₇	R ₈
191	Ph	H	-CH ₃	-CH ₃	H	H	H
192	1-naphtyl	H	-CH ₃	-CH ₃	H	H	H
193	2-naphtyl	H	-CH ₃	-CH ₃	H	H	H
194	o-biphenylyl	H	-CH ₃	-CH ₃	H	H	H
195	m-biphenylyl	H	-CH ₃	-CH ₃	H	H	H
196	p-biphenylyl	H	-CH ₃	-CH ₃	H	H	H
197	o-tolyl	H	-CH ₃	-CH ₃	H	H	H
198	m-tolyl	H	-CH ₃	-CH ₃	H	H	H
199	p-tolyl	H	-CH ₃	-CH ₃	H	H	H
200	Ph	H	H	H	H	-CH ₃	H
201	1-naphtyl	H	H	H	H	-CH ₃	H
202	2-naphtyl	H	H	H	H	-CH ₃	H
203	o-biphenylyl	H	H	H	H	-CH ₃	H
204	m-biphenylyl	H	H	H	H	-CH ₃	H
205	p-biphenylyl	H	H	H	H	-CH ₃	H
206	o-tolyl	H	H	H	H	-CH ₃	H
207	m-tolyl	H	H	H	H	-CH ₃	H
208	p-tolyl	H	H	H	H	-CH ₃	H
209	Ph	H	H	H	H	H	-CH ₃
210	1-naphtyl	H	H	H	H	H	-CH ₃
211	2-naphtyl	H	H	H	H	H	-CH ₃
212	o-biphenylyl	H	H	H	H	H	-CH ₃
213	m-biphenylyl	H	H	H	H	H	-CH ₃
214	p-biphenylyl	H	H	H	H	H	-CH ₃
215	o-tolyl	H	H	H	H	H	-CH ₃
216	m-tolyl	H	H	H	H	H	-CH ₃
217	p-tolyl	H	H	H	H	H	-CH ₃
218	Ph	H	H	H	H	-CH ₃	-CH ₃
219	1-naphtyl	H	H	H	H	-CH ₃	-CH ₃
220	2-naphtyl	H	H	H	H	-CH ₃	-CH ₃
221	o-biphenylyl	H	H	H	H	-CH ₃	-CH ₃
222	m-biphenylyl	H	H	H	H	-CH ₃	-CH ₃
223	p-biphenylyl	H	H	H	H	-CH ₃	-CH ₃
224	o-tolyl	H	H	H	H	-CH ₃	-CH ₃
225	m-tolyl	H	H	H	H	-CH ₃	-CH ₃
226	p-tolyl	H	H	H	H	-CH ₃	-CH ₃
227	Ph	H	H	H	H	H	DPA
228	1-naphtyl	H	H	H	H	H	DPA
229	2-naphtyl	H	H	H	H	H	DPA
230	o-biphenylyl	H	H	H	H	H	DPA
231	m-biphenylyl	H	H	H	H	H	DPA
232	p-biphenylyl	H	H	H	H	H	DPA
233	Ph	H	H	H	H	DPA	H
234	1-naphtyl	H	H	H	H	DPA	H
235	2-naphtyl	H	H	H	H	DPA	H
236	o-biphenylyl	H	H	H	H	DPA	H
237	m-biphenylyl	H	H	H	H	DPA	H
238	p-biphenylyl	H	H	H	H	DPA	H
239	Ph	H	H	H	H	H	TPA
240	1-naphtyl	H	H	H	H	H	TPA
241	2-naphtyl	H	H	H	H	H	TPA
242	o-biphenylyl	H	H	H	H	H	TPA
243	m-biphenylyl	H	H	H	H	H	TPA
244	p-biphenylyl	H	H	H	H	H	TPA
245	Ph	H	H	H	H	TPA	H
246	1-naphtyl	H	H	H	H	TPA	H
247	2-naphtyl	H	H	H	H	TPA	H
248	o-biphenylyl	H	H	H	H	TPA	H
249	m-biphenylyl	H	H	H	H	TPA	H
250	p-biphenylyl	H	H	H	H	TPA	H

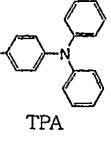
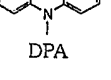
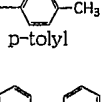
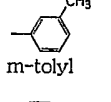
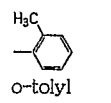
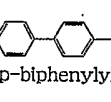
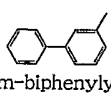
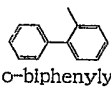
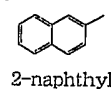
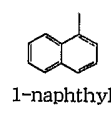

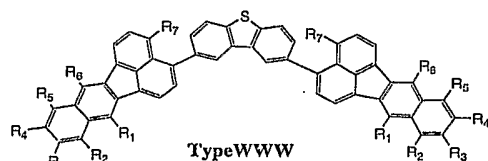

	R ₁	R ₂	R ₃	R ₄	R ₅	R ₆	R ₇
1	H	H	H	H	H	H	H
2	Ph	H	H	H	H	Ph	H
3	Ph	Ph	H	H	Ph	Ph	H
4	Ph	H	Ph	Ph	H	Ph	H
5	Ph	H	Ph	H	H	Ph	H
6	Ph	H	H	H	H	Ph	Ph
7	Ph	Me	H	H	Me	Ph	H
8	Ph	H	Me	Me	H	Ph	H
9	Ph	H	H	H	H	Ph	Me
10		H	H	H	H		H
11		Ph	H	H	Ph		H
12		H	Ph	Ph	H		H
13		H	Ph	H	H		H
14		H	H	H	H		Ph
15		Me	H	H	Me		H
16		H	Me	Me	H		H
17		H	H	H	H		Me
18		H	H	H	H		H
19		Ph	H	H	Ph		H
20		H	Ph	Ph	H		H
21		H	Ph	H	H		H
22		H	H	H	H		Ph
23		Me	H	H	Me		H
24		H	Me	Me	H		H
25		H	H	H	H		Me

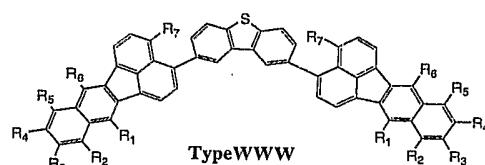

	R ₁	R ₂	R ₃	R ₄	R ₅	R ₆	R ₇
26		H	H	H	H		H
27		Ph	H	H	Ph		H
28		H	Ph	Ph	H		H
29		H	Ph	H	H		H
30		H	H	H	H		Ph
31		Me	H	H	Me		H
32		H	Me	Me	H		H
33		H	H	H	H		Me
34		H	H	H	H		H
35		Ph	H	H	Ph		H
36		H	Ph	Ph	H		H
37		H	Ph	H	H		H
38		H	H	H	H		Ph
39		Me	H	H	Me		H
40		H	Me	Me	H		H
41		H	H	H	H		Me
42		H	H	H	H		H
43		Ph	H	H	Ph		H
44		H	Ph	Ph	H		H
45		H	Ph	H	H		H
46		H	H	H	H		Ph
47		Me	H	H	Me		H
48		H	Me	Me	H		H
49		H	H	H	H		Me

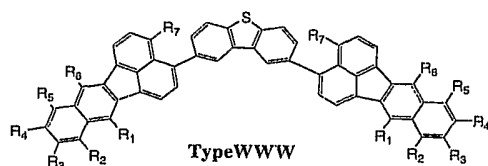

	R ₁	R ₂	R ₃	R ₄	R ₅	R ₆	R ₇
50	Ph	H	H	H	H		H
51	Ph	H	H	H	H		H
52	Ph	H	H	H	H		H
53	Ph	H	H	H	H		H
54	Ph	H	H	H	H		H
55		H	H	H	H		H
56		H	H	H	H		H
57		H	H	H	H		H
58		H	H	H	H		H
59		H	H	H	H		H
60		H	H	H	H		H
61		H	H	H	H		H
62		H	H	H	H		H
63		H	H	H	H		H
64		H	H	H	H		H
65	H	Ph	H	H	Ph	H	H
66	H		H	H		H	H
67	H		H	H		H	H
68	H		H	H		H	H
69	H		H	H		H	H
70	H		H	H		H	H
71	H	H			H	H	H
72	H	H			H	H	H
73	H	H			H	H	H
74	H	H			H	H	H
75	H	H			H	H	H

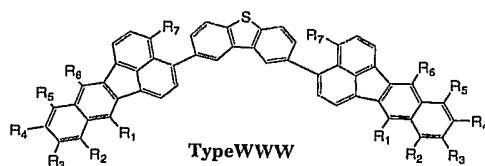

	R ₁	R ₂	R ₃	R ₄	R ₅	R ₆	R ₇
76		H	H	H	H		H
77		Ph	H	H	Ph		H
78		H	Ph	Ph	H		H
79		H	Ph	H	H		H
80		H	H	H	H		Ph
81		Me	H	H	Me		H
82		H	Me	Me	H		H
83		H	H	H	H		Me
84		H	H	H	H		H
85		Ph	H	H	Ph		H
86		H	Ph	Ph	H		H
87		H	Ph	H	H		H
88		H	H	H	H		Ph
89		Me	H	H	Me		H
90		H	Me	Me	H		H
91		H	H	H	H		Me
92		H	H	H	H		H
93		Ph	H	H	Ph		H
94		H	Ph	Ph	H		H
96		H	Ph	H	H		H
96		H	H	H	H		Ph
97		Me	H	H	Me		H
98		H	Me	Me	H		H
99		H	H	H	H		Me

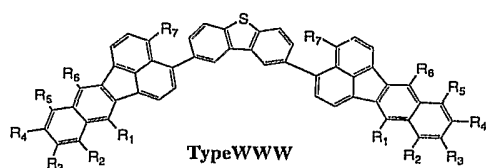

	R ₁	R ₂	R ₃	R ₄	R ₅	R ₆	R ₇
100		H	H	H	H		H
101		Ph	H	H	Ph		H
102		H	Ph	Ph	H		H
103		H	Ph	H	H		H
104		H	H	H	H		Ph
105		Me	H	H	Me		H
106		H	Me	Me	H		H
107		H	H	H	H		Me
108		H	H	H	H		H
109		Ph	H	H	Ph		H
110		H	Ph	Ph	H		H
111		H	Ph	H	H		H
112		H	H	H	H		Ph
113		Me	H	H	Me		H
114		H	Me	Me	H		H
115		H	H	H	H		Me
116		H	H	H	H		H
117		Ph	H	H	Ph		H
118		H	Ph	Ph	H		H
119		H	Ph	H	H		H
120		H	H	H	H		Ph
121		Me	H	H	Me		H
122		H	Me	Me	H		H
123		H	H	H	H		Me

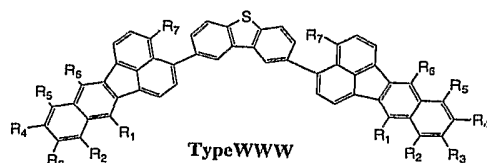

	R ₁	R ₂	R ₃	R ₄	R ₅	R ₆	R ₇
124		H	H	H	H		H
125		Ph	H	H	Ph		H
126		H	Ph	Ph	H		H
127		H	Ph	H	H		H
128		H	H	H	H		Ph
129		Me	H	H	Me		H
130		H	Me	Me	H		H
131		H	H	H	H		Me
132		H	H	H	H		H
133		Ph	H	H	Ph		H
134		H	Ph	Ph	H		H
135		H	Ph	H	H		H
136		H	H	H	H		Ph
137		Me	H	H	Me		H
138		H	Me	Me	H		H
139		H	H	H	H		Me
140		H	H	H	H		H
141		Ph	H	H	Ph		H
142		H	Ph	Ph	H		H
143		H	Ph	H	H		H
144		H	H	H	H		Ph
145		Me	H	H	Me		H
146		H	Me	Me	H		H
147		H	H	H	H		Me

式 (I) で表されるフルオランテン誘導体は、例えば、J. Amer. Chem. Soc. 118,2374 (1996) に載の方法に従って製造することができる。以下にその合成スキームの一例を示す。

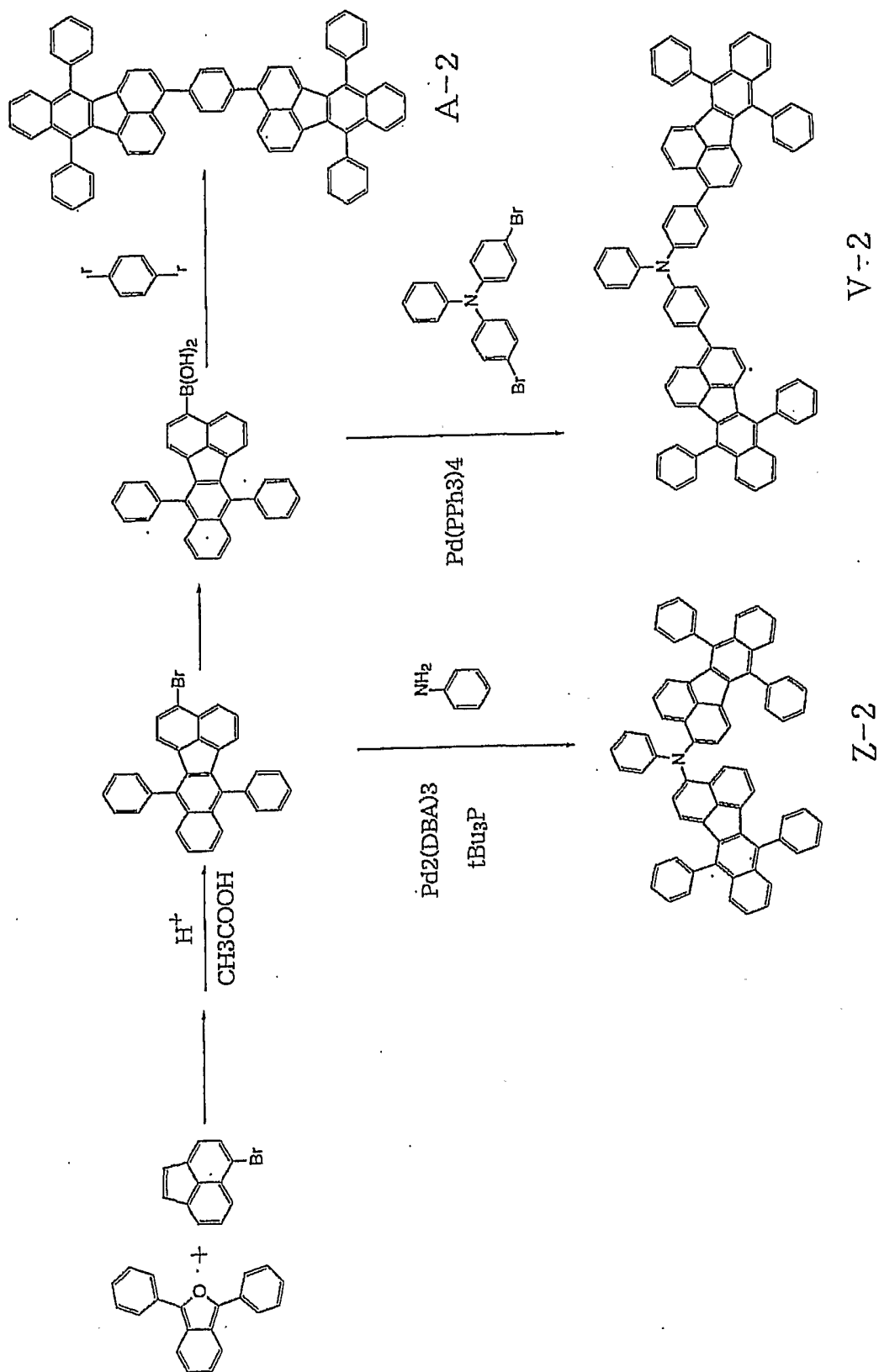

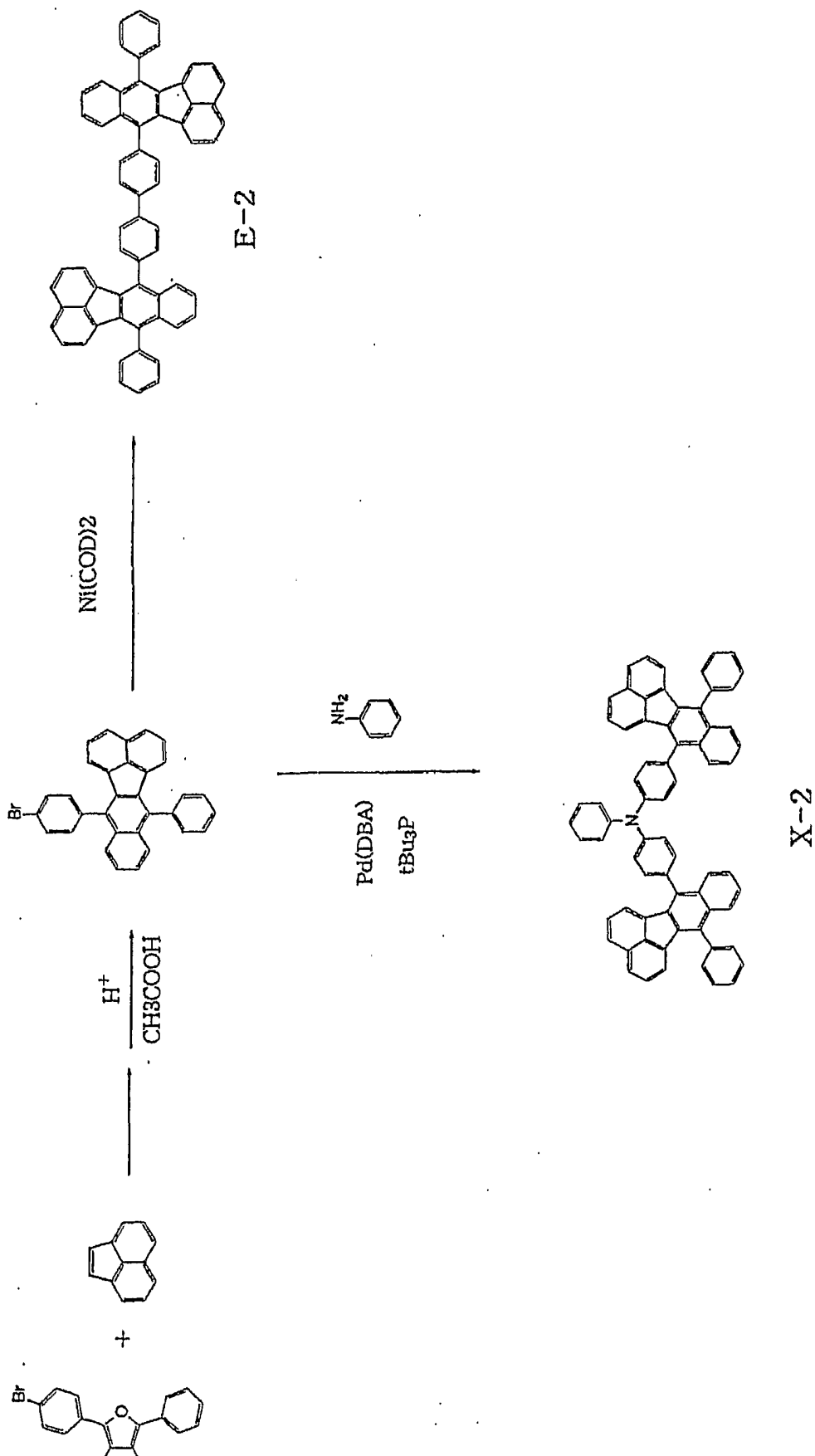

本発明の化合物は、有機EL素子の蛍光材料として極めて優れた特性を有する。特に、ドーパントとして用いた場合、色座標において $x = 0.05 \sim 0.20$ 、 $y = 0.02 \sim 0.30$ 、特に $x = 0.10 \sim 0.20$ 、 $y = 0.05 \sim 0.20$ で示されるような純青に近い発光色が得られる。

5 本発明の化合物は極めて安定であり、蒸着、塗布等有機EL素子の製造工程においても安定した特性を示し、製造後も長期に渡って安定した特性を維持する。

本発明の化合物の有機EL素子に用いる場合、ホスト材料としても、ドーパントとしても用いることができ、特にドーパントとして用いた場合、上記のような優れた発光色と、発光効率を得ることができる。本発明の化合物は、電子注入輸
10 送性、ホール注入性、または輸送性のいずれの性質も有することから、電子輸送材料としても、ホール注入、または輸送材料としても用いることができる。

有機EL素子のホスト材料と、ドーパントとの組み合わせを決定するにあたり、以下の点を考慮することが重要である。

(1) 構造式により組み合わせを考える。すなわち、化合物の構造そのものが発
15 光特性に影響を与える。

(2) ドーパント（発光材料）のイオン化ポテンシャルは、ホスト材料のイオン化ポテンシャルと同等か、これよりも小さいことが望ましい。ドーパントは発光させた際にホールトラップとして機能し、ドーパントの1重項励起子が生成しやすくなる。また、このような場合、ホストの1重項励起子と基底状態のドーパントとのエネルギー交換が生じやすくなり、発光効率が向上する。
20

(3) ドーパント（発光材料）の半波酸化電位は、ホスト材料の半波酸化電位と同等か、これよりも小さいことが望ましい。ドーパントは発光させた際にホールトラップとして機能し、ドーパントの1重項励起子が生成しやすくなる。また、このような場合、ホストの1重項励起子と基底状態のドーパントとのエネルギー
25 交換が生じやすくなり、発光効率が向上する。

本発明の化合物を発光層に用いる場合、ホスト材料としても、ドーパントとしても用いることができ、特に青色発光用ドーパントとしての使用が好ましい。本発明の化合物をドーパントとして用いる場合、ホスト材料にはアントラセン系の材料を用いることが好ましい。また、電子輸送性材料とホール輸送性材料の混合

5 材料をホストとする混合層での使用も好ましい。発光層には本発明の化合物以外に複数の種類の化合物を含有していてもよく、このような複数種類の化合物を含有する発光層、あるいは複数種類の発光層を積層することで複数のピーク波長を有したり、ワイド発光波長の発光層または素子を得ることも可能である。

本発明の化合物をホスト材料として使用する場合、ドーパントには種々の有機

10 EL用蛍光物質を用いることができる。なかでも、下記の実施例で用いるナフタセン系のルブレン誘導体やジフェニルナフタセン誘導体、ペリレン系赤色蛍光材料、ペンタセン系赤色蛍光材料、ジスチリルアミン誘導体系材料等が好ましい。

本発明の化合物をホール注入輸送層に用いる場合、ホール輸送性材料としても、発光材料としても用いることができる。ホール輸送性材料として用いる場合、ド

15 ーパントとして上記で挙げたものを用いることができる。

本発明の化合物を電子注入輸送層に用いる場合、電子輸送性材料としても、発光材料としても用いることができる。電子輸送性材料として用いる場合、ドーパントとして上記で挙げたものを用いることができる。また、この電子注入輸送層が上記混合層であってもよい。

本発明の化合物をドーパントとして用いる場合、そのドーピング量としては、好ましくは30質量%以下、より好ましくは0.1~20質量%、さらには0.1~10質量%、特に0.1~5質量%である。

本発明の化合物を有機EL素子に用いることにより、以下のような優れた効果が得られる。

25 (1) モノマー系 ($n=1$) をアントラセン系のホスト材料で発光させることは

極めて困難であるが、本発明の化合物は容易に発光し、極めて高い発光輝度が得られる。

(2) 連結基 Y により発光色をコントロールすることができる。すなわち、例えば Y をアミノ基にすると緑色系の発光が得られ、トリフェニルアミンにすると水
5 色系の発光が得られる。従って、発光色の調整が容易に行える。

(3) Z 位置で単結合した X の 2 量体は、昇華精製、蒸着時などに分子内重合もしくは分解しやすいが、本発明の化合物は極めて安定であるため使いやすい。

(4) 縮合多環芳香族炭化水素化合物でありながら、電子、ホール両方を輸送する必要のある有機 EL 用材料に極めて適した材料である。

10 (5) 発光材料として優れた性能を有し、NTSC 信号に近い純青色で 7.3 cd/A という高効率で発光させることができる。

(6) ホスト材料として優れた性能を有し、ナフタセン誘導体、ルブレン誘導体、ペリレン誘導体、クマリン誘導体、スチリルアミン誘導体など、幅広い化合物と組み合わせる用いることができる。

15 (7) 高いガラス転移温度 (T_g) を有し、高温保存特性に優れた素子を得ることができる。

上記のようなホスト材料とドーパントとを含有する発光層は、ホール（正孔）および電子の注入機能、それらの輸送機能、ホールと電子の再結合により励起子を生成させる機能を有する。発光層は本発明の化合物の他、比較的電子的にニュ
20 ートラルな化合物を用いることで、電子とホールを容易かつバランスよく注入・輸送することができる。

ホスト材料は、単独で用いてもよいし、2 種以上を混合して用いてもよい。2 種以上を混合して用いる場合の混合比は任意である。本発明の化合物をホスト材料とする場合、発光層に 80~99.9 質量%含有されていることが好ましく、
25 特に 90~99.9 質量%、さらには 95.0~99.5 質量%含有されている

ことが好ましい。

また、発光層の厚さは、分子層一層に相当する厚みから、有機化合物層の膜厚未満とすることが好ましく、具体的には1～85nmとすることが好ましく、さらには5～60nm、特には5～50nmとすることが好ましい。

- 5 また、混合層の形成方法としては、異なる蒸着源より蒸発させる共蒸着が好ましいが、蒸気圧（蒸発温度）が同程度あるいは非常に近い場合には、予め同じ蒸着ボード内で混合させておき、蒸着することもできる。混合層は化合物同士が均一に混合している方が好ましいが、場合によっては、化合物が島状に存在するものであってもよい。発光層は、一般的には、有機蛍光物質を蒸着するか、あるいは樹脂バインダー中に分散させてコーティングすることにより、発光層を所定の
- 10 厚さに形成する。

<アントラセン系化合物>

本発明の素子の好ましいホスト材料の一つである、フェニルアントラセン誘導体は式（5）で示されるものである。

- 15 本発明の素子では式（5）、好ましくは式（5-1）、式（5-2）に示されるアントラセン誘導体を好ましくはホスト材料として用いることにより、ドーパント材料との相互作用を抑え、ドーパントからの強い発光を得ることが出来る。また、このアントラセン誘導体は、耐熱性、耐久性に優れ、長寿命の素子を得ることができる。

- 20 このEL素子において、素子の色純度を保ち、かつ効率が最大となるドーピング濃度は、1質量%程度であるが、2～3質量%程度でも1割程度以下の減少のみで、十分に実用に耐えうる素子を得ることができる。

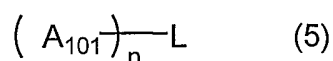

式（5）において、 A_{101} は、モノフェニルアントリル基またはジフェニルア

ントリル基を表し、これらは同一でも異なるものであってもよい。Lは水素、単結合または二価の連結基を表す。nは1または2の整数である。

上記式(5)、好ましくは下記式(5-1)、式(5-2)に示される化合物である。

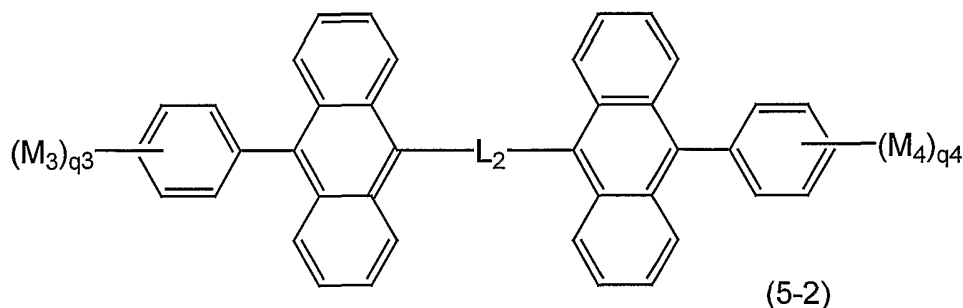
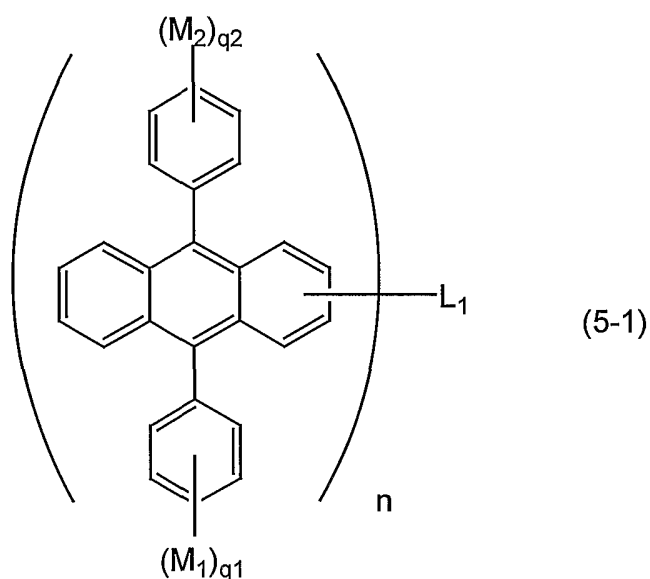

上記化合物の蒸着膜は安定なアモルファス状態なので、薄膜の膜物性が良好となりムラがなく均一な発光が可能である。また、大気下で一年以上安定であり結晶化を起こさない。

式(5)について説明すると、 A_{101} は、各々モノフェニルアントリル基またはジフェニルアントリル基を表し、これらは同一でも異なるものであってもよい。nは1または2の整数である。

A_{101} で表されるモノフェニルアントリル基またはジフェニルアントリル基は、

無置換でも置換基を有するものであってもよく、置換基を有する場合の置換基としては、アルキル基、アリール基、アルコキシ基、アリーロキシ基、アミノ基等が挙げられ、これらの置換基はさらに置換されていてもよい。これらの置換基については後述する。また、このような置換基の置換位置は特に限定されないが、
5 アントラセン環ではなく、アントラセン環に結合したフェニル基であることが好ましい。

また、アントラセン環におけるフェニル基の結合位置はアントラセン環の9位、10位であることが好ましい。

式(5-1)において、Lは水素、単結合または二価の基を表すが、Lで表される二価の基としてはアルキレン基等が介在してもよいアリーレン基が好ましい。
10 このようなアリーレン基については後述する。

式(5)で示されるフェニルアントラセン誘導体のなかでも、式(5-1)、式(5-2)で示されるものが好ましい。式(5-1)について説明すると、式(5)において、 M_1 および M_2 は、各々アルキル基、シクロアルキル基、アリール基、アルコキシ基、アリーロキシ基、アミノ基または複素環基を表す。
15

M_1 、 M_2 で表されるアルキル基としては、直鎖状でも分岐を有するものであってもよく、炭素数1~10、さらには1~4の置換もしくは無置換のアルキル基が好ましい。特に、炭素数1~4の無置換のアルキル基が好ましく、具体的にはメチル基、エチル基、(n-, i-) プロピル基、(n-, i-, s-, t-)
20 -) ブチル基等が挙げられる。

M_1 、 M_2 で表されるシクロアルキル基としては、シクロヘキシル基、シクロペンチル基等が挙げられる。

M_1 、 M_2 で表されるアリール基としては、炭素数6~20のものが好ましく、さらにはフェニル基、トリル基等の置換基を有するものであってもよい。具体的
25 には、フェニル基、(o-, m-, p-) トリル基、ピレニル基、ナフチル基、

アントリル基、ビフェニル基、フェニルアントリル基、トリルアントリル基等が挙げられる。

M_1 、 M_2 で表されるアルケニル基としては、総炭素数 6 ~ 50 のものが好ましく、無置換のものであってもよいが置換基を有するものであってもよく、置換
5 基を有する方が好ましい。このときの置換基としては、フェニル基等のアリアル基が好ましい。具体的には、トリフェニルビニル基、トリトリルビニル基、トリビフェニルビニル基等が挙げられる。

M_1 、 M_2 で表されるアルコキシ基としては、アルキル基部分の炭素数が 1 ~ 6 のものが好ましく、具体的にはメトキシ基、エトキシ基等が挙げられる。アル
10 コキシ基は、さらに置換されていてもよい。

M_1 、 M_2 で表されるアリーロキシ基としては、フェノキシ基等が挙げられる。

M_1 、 M_2 で表されるアミノ基は、無置換でも置換基を有するものであってもよいが、置換基を有することが好ましく、この場合の置換基としてはアルキル基
15 (メチル基、エチル基等)、アリアル基(フェニル基等)などが挙げられる。具体的にはジエチルアミノ基、ジフェニルアミノ基、ジ(m-トリル)アミノ基等が挙げられる。

M_1 、 M_2 で表される複素環基としては、ビピリジル基、ピリミジル基、キノリル基、ピリジル基、チエニル基、フリル基、オキサジアゾイル基等が挙げられる。これらは、メチル基、フェニル基等の置換基を有していてもよい。

20 式(5-1)において、 q_1 および q_2 は、各々、0 または 1 ~ 5 の整数を表し、特に、0 または 1 であることが好ましい。 q_1 および q_2 が、各々、1 ~ 5 の整数、特に 1 または 2 であるとき、 M_1 および M_2 は、各々、アルキル基、アリアル基、アルケニル基、アルコキシ基、アリーロキシ基、アミノ基であることが好ましい。

25 式(5-1)において、 M_1 と M_2 とは同一でも異なるものであってもよく、

M_1 と M_2 とが各々複数存在するとき、 M_1 同士、 M_2 同士は各々同一でも異なるものであってもよく、 M_1 同士あるいは M_2 同士は結合してベンゼン環等の環を形成してもよく、環を形成する場合も好ましい。

式 (5-1) において、 L_1 は水素、単結合またはアリーレン基を表す。 L_1 で表されるアリーレン基としては、無置換であることが好ましく、具体的にはフェニレン基、ビフェニレン基、アントリレン基等の通常のアリーレン基の他、2個ないしそれ以上のアリーレン基が直接連結したものが挙げられる。 L_1 としては、単結合、*p*-フェニレン基、4, 4'-ビフェニレン基等が好ましい。

また、 L_1 で表されるアリーレン基は、2個ないしそれ以上のアリーレン基がアルキレン基、-O-、-S-または-NR-が介在して連結するものであってもよい。ここで、Rはアルキル基またはアリール基を表す。アルキル基としてはメチル基、エチル基等が挙げられ、アリール基としてはフェニル基等が挙げられる。なかでも、アリール基が好ましく、上記のフェニル基のほか、 A_{101} であってもよく、さらにはフェニル基に A_{101} が置換したものであってもよい。

また、アルキレン基としてはメチレン基、エチレン基等が好ましい。このようなアリーレン基の具体例を以下に示す。

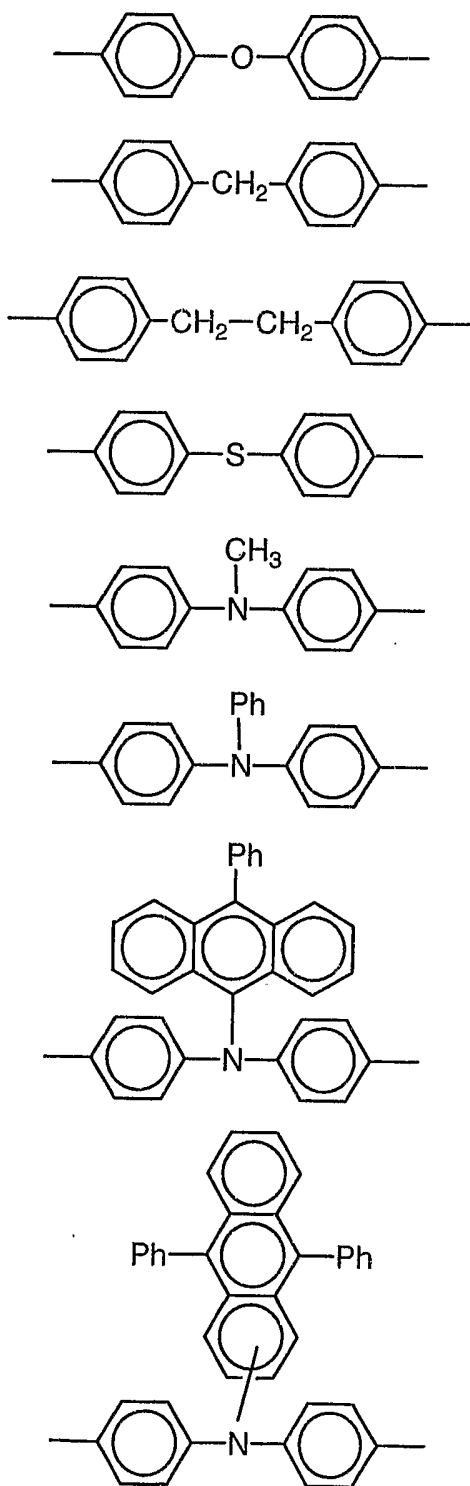

次に、式(5-2)について説明すると、式(5-2)において、 M_3 および M_4 は式(5-1)における M_1 および M_2 と、また q_3 および q_4 は式(5-1)における q_1 および q_2 と、さらに L_2 は式(5-1)における L_1 とそれぞれ同義であり、好ましいものも同様である。

- 5 式(5-2)において、 M_3 と M_4 とは同一でも異なるものであってもよく、 M_3 と M_4 が各々複数存在するとき、 M_3 同士、 M_4 同士は、各々同一でも異なるものであってもよく、 M_3 同士あるいは M_4 同士は結合してベンゼン環等の環を形成してもよく、環を形成する場合も好ましい。

10 式(5-1)、式(5-2)で表される化合物を以下に例示するが、本発明はこれらに限定されるものではない。なお、化41、化43、化45、化47、化49、化51、化53、化56では一般式を示し、化42、化44、化46、化48、化50、化52、化54、化55、化57で、各々対応する具体例を M_{11} ~ M_{15} 、 M_{21} ~ M_{25} あるいは M_{31} ~ M_{35} 、 M_{41} ~ M_{45} の組合せで示している。

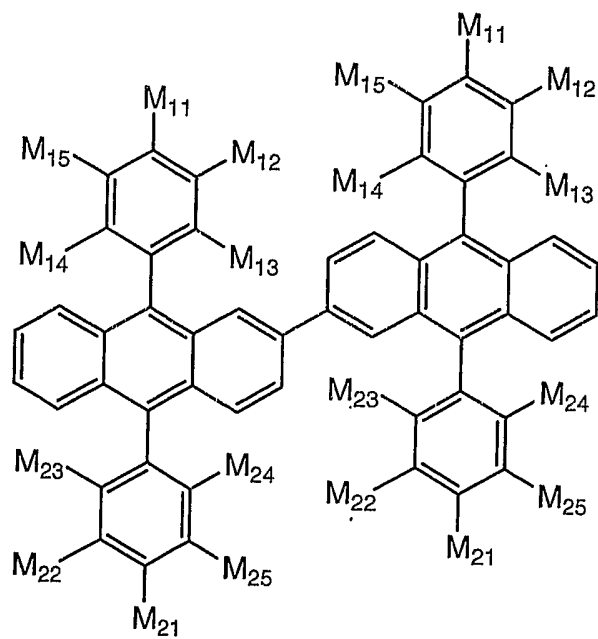

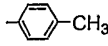
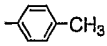
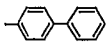
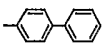
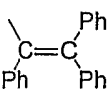
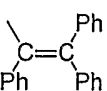
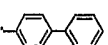
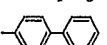
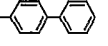
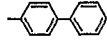
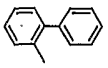
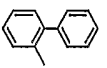
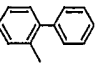
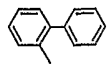
化合物 No.	M ₁₁	M ₁₂	M ₁₃	M ₁₄	M ₁₅	M ₂₁	M ₂₂	M ₂₃	M ₂₄	M ₂₅
I-1	H	H	H	H	H	H	H	H	H	H
I-2	CH ₃	H	H	H	H	CH ₃	H	H	H	H
I-3	t-C ₄ H ₉	H	H	H	H	t-C ₄ H ₉	H	H	H	H
I-4	OCH ₃	H	H	H	H	OCH ₃	H	H	H	H
I-5	OPh	H	H	H	H	OPh	H	H	H	H
I-6	N(C ₂ H ₅) ₂	H	H	H	H	N(C ₂ H ₅) ₂	H	H	H	H
I-7	N(Ph) ₂	H	H	H	H	N(Ph) ₂	H	H	H	H
I-8	Ph	H	H	H	H	Ph	H	H	H	H
I-9		H	H	H	H		H	H	H	H
I-10	H	CH ₃	H	H	H	H	CH ₃	H	H	H
I-11	H	CH ₃	H	CH ₃	H	H	CH ₃	H	CH ₃	H
I-12	H	H	CH ₃	H	H	H	H	CH ₃	H	H
I-13	H	CH ₃	H	H	CH ₃	H	CH ₃	H	H	CH ₃
I-14	t-C ₄ H ₉	H	H	H	H	H	H	H	H	H
I-15		H	H	H	H		H	H	H	H
I-16	H	Ph	H	H	H	H	Ph	H	H	H
I-17	H	H	Ph	H	H	H	H	Ph	H	H
I-18		H	H	H	H		H	H	H	H
I-19	n-C ₄ H ₉	H	H	H	H	n-C ₄ H ₉	H	H	H	H
I-20		H	H	H	H		H	H	H	H
I-21	H	H		H	H	H	H		H	H
I-22		H	H	H	H		H	H	H	H
I-23	H	H		H	H	H	H		H	H
I-24	H	H	Ph	H	Ph	H	H	Ph	H	Ph
I-25	H	H	Ph	Ph	H	H	H	Ph	Ph	H

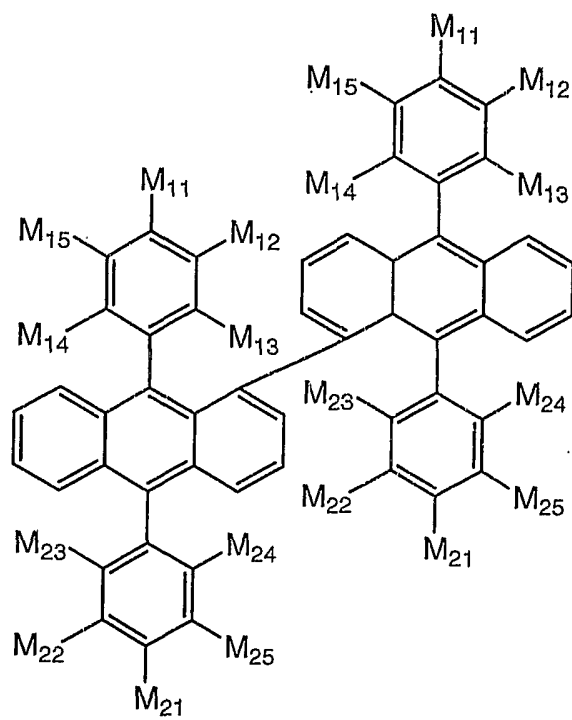

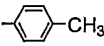
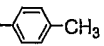
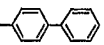
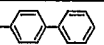
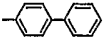
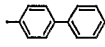
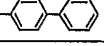
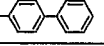
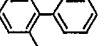
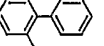
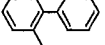
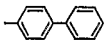
化合物 No.	M ₁₁	M ₁₂	M ₁₈	M ₁₄	M ₁₅	M ₂₁	M ₂₂	M ₂₃	M ₂₄	M ₂₅
II-1	H	H	H	H	H	H	H	H	H	H
II-2	CH ₃	H	H	H	H	CH ₃	H	H	H	H
II-3	t-C ₄ H ₉	H	H	H	H	t-C ₄ H ₉	H	H	H	H
II-4	OCH ₃	H	H	H	H	OCH ₃	H	H	H	H
II-5	OPh	H	H	H	H	OPh	H	H	H	H
II-6	N(C ₂ H ₅) ₂	H	H	H	H	N(C ₂ H ₅) ₂	H	H	H	H
II-7	N(Ph) ₂	H	H	H	H	N(Ph) ₂	H	H	H	H
II-8	Ph	H	H	H	H	Ph	H	H	H	H
II-9		H	H	H	H		H	H	H	H
II-10	H	CH ₃	H	H	H	H	CH ₃	H	H	H
II-11	H	H	CH ₃	H	H	H	CH ₃	CH ₃	H	H
II-12	H	H	CH ₃	CH ₃	H	H	H	CH ₃	CH ₃	H
II-13	H	H	CH ₃	H	CH ₃	H	CH ₃	CH ₃	H	CH ₃
II-14	CH ₃	CH ₃	CH ₃	CH ₃	CH ₃	CH ₃	CH ₃	CH ₃	CH ₃	CH ₃
II-15	t-C ₄ H ₉	H	H	H	H	H	H	H	H	H
II-16		H	H	H	H		H	H	H	H
II-17	H	Ph	H	H	H	H	Ph	H	H	H
II-18	H	H	Ph	H	H	H	H	Ph	H	H
II-19	H	H		H	H	H	H		H	H
II-20		H	H	H	H		H	H	H	H
II-21		H	H	H	H		H	H	H	H
II-22	H	H		H	H	H	H		H	H
II-23	H	H	Ph	H	Ph	H	H	Ph	H	Ph
II-24	H	H	Ph	Ph	H	H	H	Ph	Ph	H

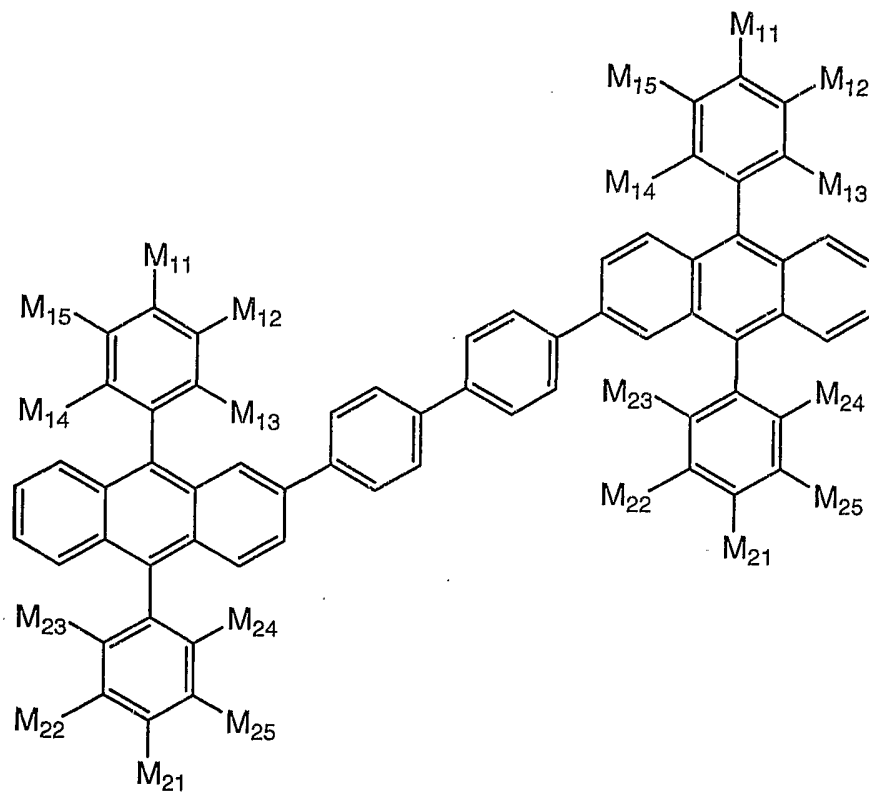

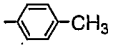
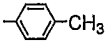
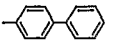
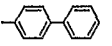
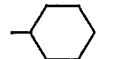
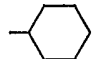
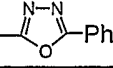
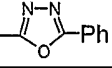
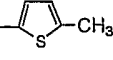
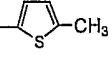
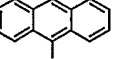
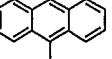
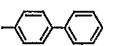
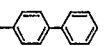
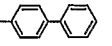
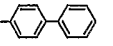
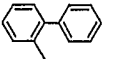
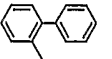
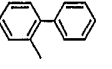
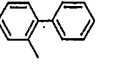

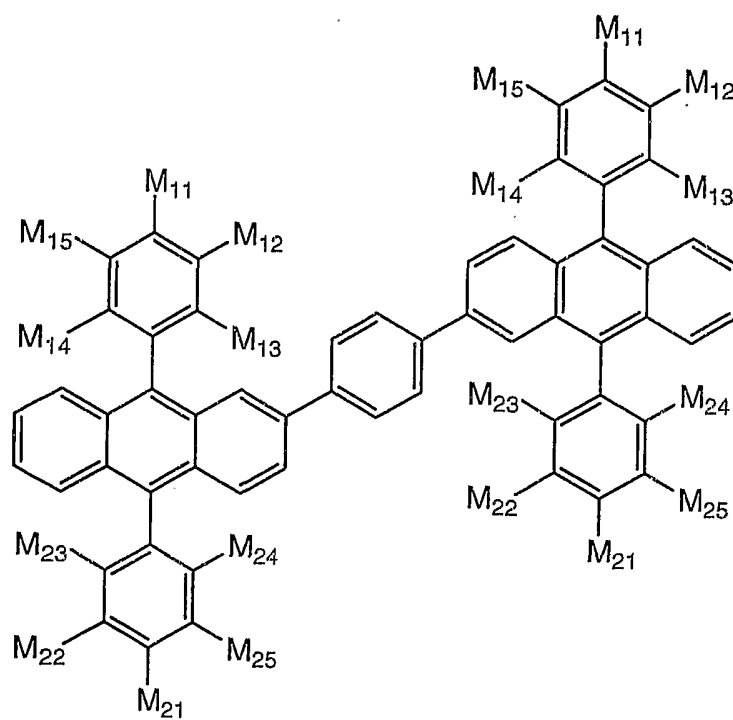

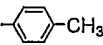
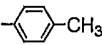
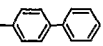
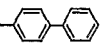
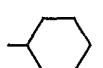
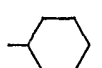
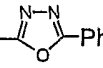
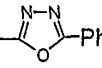
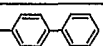
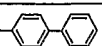
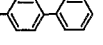
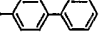
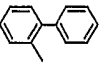
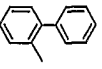
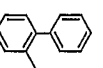
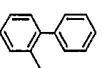

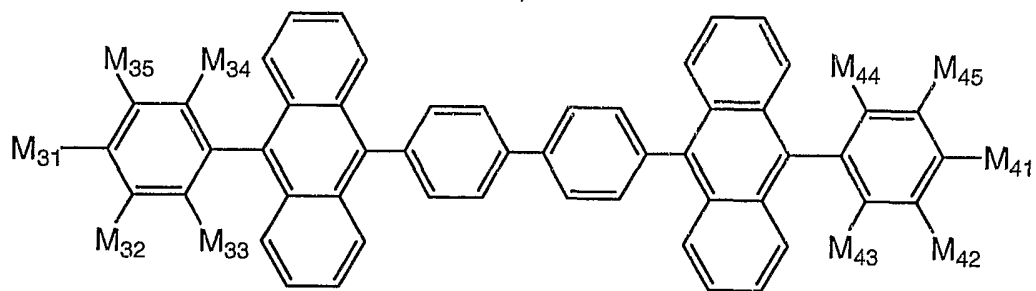
化合物 No.	M ₁₁	M ₁₂	M ₁₃	M ₁₄	M ₁₅	M ₂₁	M ₂₂	M ₂₃	M ₂₄	M ₂₅
III-1	H	H	H	H	H	H	H	H	H	H
III-2	CH ₃	H	H	H	H	CH ₃	H	H	H	H
III-3	t-C ₄ H ₉	H	H	H	H	t-C ₄ H ₉	H	H	H	H
III-4	OCH ₃	H	H	H	H	OCH ₃	H	H	H	H
III-5	OPh	H	H	H	H	OPh	H	H	H	H
III-6	N(C ₂ H ₅) ₂	H	H	H	H	N(C ₂ H ₅) ₂	H	H	H	H
III-7	N(Ph) ₂	H	H	H	H	N(Ph) ₂	H	H	H	H
III-8	Ph	H	H	H	H	Ph	H	H	H	H
III-9		H	H	H	H		H	H	H	H
III-10	H	CH ₃	H	H	H	H	CH ₃	H	H	H
III-11	H	H	CH ₃	H	H	H	H	CH ₃	H	H
III-12	H	H	CH ₃	CH ₃	H	H	H	CH ₃	CH ₃	H
III-13	H	H	CH ₃	H	CH ₃	H	H	CH ₃	H	CH ₃
III-14	CH ₃	CH ₃	CH ₃	CH ₃	CH ₃	CH ₃	CH ₃	CH ₃	CH ₃	CH ₃
III-15	H	Ph	H	H	H	H	Ph	H	H	H
III-16	H	H	Ph	H	H	H	H	Ph	H	H
III-17		H	H	H	H		H	H	H	H
III-18	t-C ₄ H ₉	H	H	H	H	H	H	H	H	H
III-19		H	H	H	H		H	H	H	H
III-20		H	H	H	H		H	H	H	H
III-21		H	H	H	H		H	H	H	H
III-22		H	H	H	H		H	H	H	H
III-23		H	H	H	H		H	H	H	H
III-24	H	H		H	H	H	H		H	H
III-25		H	H	H	H		H	H	H	H
III-26	H	H		H	H	H	H		H	H
III-27	H	H	Ph	H	Ph	H	H	Ph	H	Ph
III-28	H	H	Ph	Ph	H	H	H	Ph	Ph	H

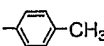
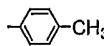
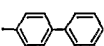
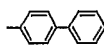
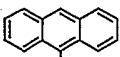
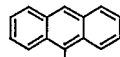
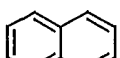
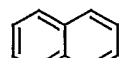

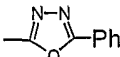
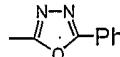
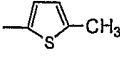
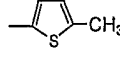
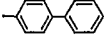
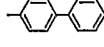

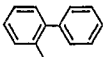
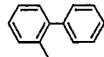
化合物 No.	M ₁₁	M ₁₂	M ₁₃	M ₁₄	M ₁₅	M ₂₁	M ₂₂	M ₂₃	M ₂₄	M ₂₅
IV-1	H	H	H	H	H	H	H	H	H	H
IV-2	CH ₃	H	H	H	H	CH ₃	H	H	H	H
IV-3	t-C ₄ H ₉	H	H	H	H	t-C ₄ H ₉	H	H	H	H
IV-4	OCH ₃	H	H	H	H	OCH ₃	H	H	H	H
IV-5	OPh	H	H	H	H	OPh	H	H	H	H
IV-6	N(C ₂ H ₅) ₂	H	H	H	H	N(C ₂ H ₅) ₂	H	H	H	H
IV-7	N(Ph) ₂	H	H	H	H	N(Ph) ₂	H	H	H	H
IV-8	Ph	H	H	H	H	Ph	H	H	H	H
IV-9		H	H	H	H		H	H	H	H
IV-10	H	CH ₃	H	H	H	H	CH ₃	H	H	H
IV-11	H	H	CH ₃	H	H	H	H	CH ₃	H	H
IV-12	H	H	CH ₃	CH ₃	H	H	H	CH ₃	CH ₃	H
IV-13	H	H	CH ₃	H	CH ₃	H	H	CH ₃	H	CH ₃
IV-14	CH ₃	CH ₃	CH ₃	CH ₃	CH ₃	CH ₃	CH ₃	CH ₃	CH ₃	CH ₃
IV-15	H	H	H	H	H	H	H	H	H	H
IV-16	H	H	Ph	H	H	H	H	Ph	H	H
IV-17		H	H	H	H		H	H	H	H
IV-18	t-C ₄ H ₉	H	H	H	H	H	H	H	H	H
IV-19		H	H	H	H		H	H	H	H
IV-20		H	H	H	H		H	H	H	H
IV-21		H	H	H	H		H	H	H	H
IV-22	H	H		H	H	H	H		H	H
IV-23		H	H	H	H		H	H	H	H
IV-24	H	H		H	H	H	H		H	H
IV-25	H	H	Ph	H	Ph	H	H	Ph	H	Ph
IV-26	H	H	Ph	Ph	H	H	H	Ph	Ph	H



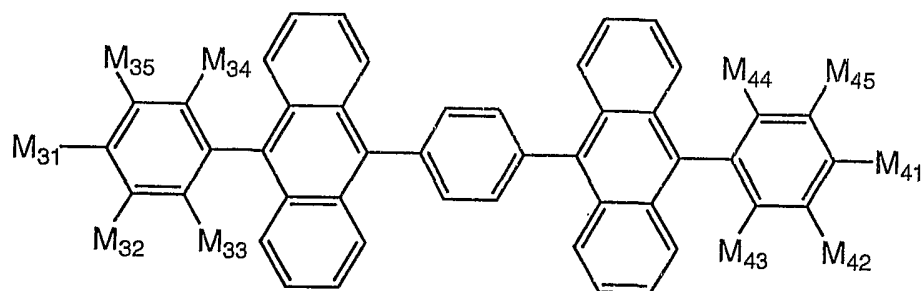

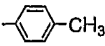
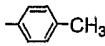
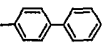
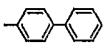
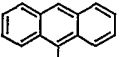
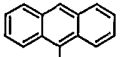
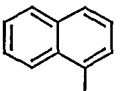
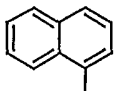
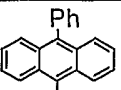
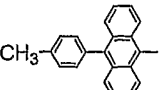

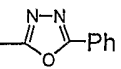
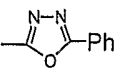
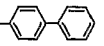
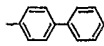
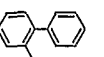
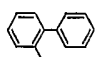

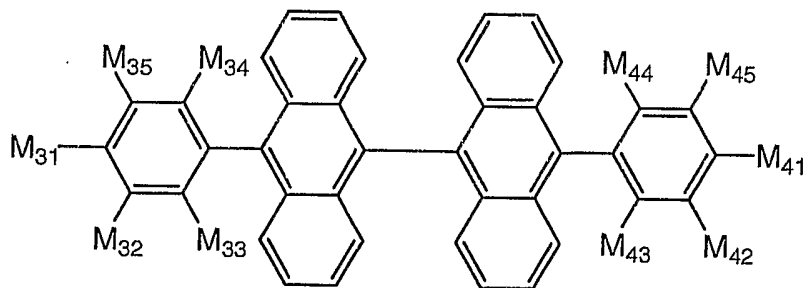

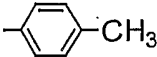
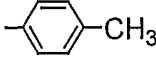

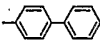

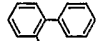
化合物 No.	M ₃₁	M ₃₂	M ₃₃	M ₃₄	M ₃₅	M ₄₁	M ₄₂	M ₄₃	M ₄₄	M ₄₅
V-1	H	H	H	H	H	H	H	H	H	H
V-2	CH ₃	H	H	H	H	CH ₃	H	H	H	H
V-3	t-C ₄ H ₉	H	H	H	H	t-C ₄ H ₉	H	H	H	H
V-4	OCH ₃	H	H	H	H	OCH ₃	H	H	H	H
V-5	OPh	H	H	H	H	OPh	H	H	H	H
V-6	N(C ₂ H ₅) ₂	H	H	H	H	N(C ₂ H ₅) ₂	H	H	H	H
V-7	N(Ph) ₂	H	H	H	H	N(Ph) ₂	H	H	H	H
V-8	Ph	H	H	H	H	Ph	H	H	H	H
V-9		H	H	H	H		H	H	H	H
V-10	H	CH ₃	H	H	H	H	CH ₃	H	H	H
V-11	H	H	CH ₃	H	H	H	H	CH ₃	H	H
V-12	H	H	CH ₃	CH ₃	H	H	H	CH ₃	CH ₃	H
V-13	H	H	CH ₃	H	CH ₃	H	H	CH ₃	H	CH ₃
V-14	CH ₃	CH ₃	CH ₃	CH ₃	CH ₃	CH ₃	CH ₃	CH ₃	CH ₃	CH ₃
V-15	H	Ph	H	H	H	H	Ph	H	H	H
V-16	H	H	Ph	H	H	H	H	Ph	H	H
V-17		H	H	H	H		H	H	H	H
V-18	t-C ₄ H ₉	H	H	H	H	t-C ₄ H ₉	H	H	H	H
V-19		H	H	H	H		H	H	H	H
V-20		H	H	H	H		H	H	H	H
V-21		H	H	H	H		H	H	H	H
V-22		H	H	H	H		H	H	H	H
V-23		H	H	H	H		H	H	H	H
V-24		H	H	H	H		H	H	H	H
V-25	H	H		H	H	H	H		H	H
V-26		H	H	H	H		H	H	H	H
V-27	H	H		H	H	H	H		H	H
V-28	H	H	Ph	H	Ph	H	H	Ph	H	Ph
V-29	H	H	Ph	Ph	H	H	H	Ph	Ph	H

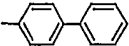
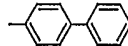

化合物 No.	M ₃₁	M ₃₂	M ₃₃	M ₃₄	M ₃₅	M ₄₁	M ₄₂	M ₄₃	M ₄₄	M ₄₅
VI-1	H	H	H	H	H	H	H	H	H	H
VI-2	CH ₃	H	H	H	H	CH ₃	H	H	H	H
VI-3	t-C ₄ H ₉	H	H	H	H	t-C ₄ H ₉	H	H	H	H
VI-4	OCH ₃	H	H	H	H	OCH ₃	H	H	H	H
VI-5	OPh	H	H	H	H	OPh	H	H	H	H
VI-6	N(C ₂ H ₅) ₂	H	H	H	H	N(C ₂ H ₅) ₂	H	H	H	H
VI-7	N(Ph) ₂	H	H	H	H	N(Ph) ₂	H	H	H	H
VI-8	Ph	H	H	H	H	Ph	H	H	H	H
VI-9		H	H	H	H		H	H	H	H
VI-10	H	CH ₃	H	H	H	H	CH ₃	H	H	H
VI-11	H	H	CH ₃	H	H	H	H	CH ₃	H	H
VI-12	H	H	CH ₃	CH ₃	H	H	H	CH ₃	CH ₃	H
VI-13	H	H	CH ₃	H	CH ₃	H	H	CH ₃	H	CH ₃
VI-14	CH ₃	CH ₃	CH ₃	CH ₃	CH ₃	CH ₃	CH ₃	CH ₃	CH ₃	CH ₃
VI-15	H	Ph	H	H	H	H	Ph	H	H	H
VI-16	H	H	Ph	H	H	H	H	Ph	H	H
VI-17		H	H	H	H		H	H	H	H
VI-18	t-C ₄ H ₉	H	H	H	H	H	H	H	H	H
VI-19		H	H	H	H		H	H	H	H
VI-20		H	H	H	H		H	H	H	H
VI-21		H	H	H	H	H	H	H	H	H
VI-22		H	H	H	H	CH ₃	H	H	H	H
VI-23		H	H	H	H		H	H	H	H
VI-24		H	H	H	H		H	H	H	H
VI-25	H	H	Ph	H	Ph	H	H	Ph	H	Ph
VI-26	H	H	Ph	Ph	H	H	H	Ph	Ph	H
VI-27	H	H		H	H	H	H		H	H
VI-28	H	H		H	H	H	H		H	H

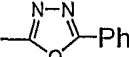
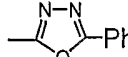
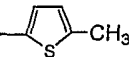
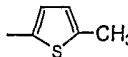
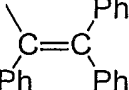
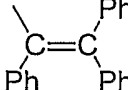
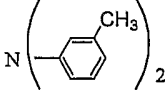
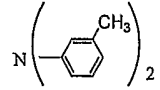
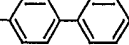
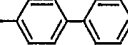

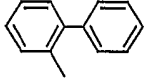
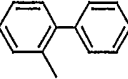
化合物 No.	M ₃₁	M ₃₂	M ₃₃	M ₃₄	M ₃₅	M ₄₁	M ₄₂	M ₄₃	M ₄₄	M ₄₅
VII-1	H	H	H	H	H	H	H	H	H	H
VII-2	CH ₃	H	H	H	H	CH ₃	H	H	H	H
VII-3	t-C ₄ H ₉	H	H	H	H	t-C ₄ H ₉	H	H	H	H
VII-4	OCH ₃	H	H	H	H	OCH ₃	H	H	H	H
VII-5	OPh	H	H	H	H	OPh	H	H	H	H
VII-6	N(C ₂ H ₅) ₂	H	H	H	H	N(C ₂ H ₅) ₂	H	H	H	H
VII-7	N(Ph) ₂	H	H	H	H	N(Ph) ₂	H	H	H	H
VII-8	Ph	H	H	H	H	Ph	H	H	H	H
VII-9		H	H	H	H		H	H	H	H
VII-10	H	H	CH ₃	CH ₃	H	H	H	CH ₃	CH ₃	H
VII-11	H	H	CH ₃	H	CH ₃	H	H	CH ₃	H	CH ₃
VII-12	H	CH ₃	H	H	H	H	CH ₃	H	H	H
VII-13	H	H	CH ₃	H	H	H	H	CH ₃	H	H
VII-14	CH ₃	CH ₃	CH ₃	CH ₃	CH ₃	CH ₃	CH ₃	CH ₃	CH ₃	CH ₃
VII-15	H	H	Ph	H	Ph	H	H	Ph	H	Ph
VII-16	H	H	Ph	Ph	H	H	H	Ph	Ph	H
VII-17	H	H		H	H	H	H		H	H
VII-18	H	H		H	H	H	H		H	H

化合物 No.	M ₃₁	M ₃₂	M ₃₃	M ₃₄	M ₃₅	M ₄₁	M ₄₂	M ₄₃	M ₄₄	M ₄₅
VII-19	H	Ph	H	H	H	H	Ph	H	H	H
VII-20	H	H	Ph	H	H	H	H	Ph	H	H
VII-21		H	H	H	H		H	H	H	H
VII-22	t-C ₄ H ₉	H	H	H	H	H	H	H	H	H
VII-23		H	H	H	H		H	H	H	H
VII-24		H	H	H	H		H	H	H	H
VII-25		H	H	H	H		H	H	H	H
VII-26		H	H	H	H		H	H	H	H
VII-27		H	H	H	H		H	H	H	H
VII-28	n-C ₄ H ₉	H	H	H	H	n-C ₄ H ₉	H	H	H	H
VII-29	H	H	OCH ₃	H	H	H	H	OCH ₃	H	H
VII-30	H	R ₃₂ とR ₃₃ とで 縮合ベンゼン環			H	H	H	R ₄₂ とR ₄₃ とで 縮合ベンゼン環		H
VII-31		H	H	H	H		H	H	H	H
VII-32		H	H	H	H		H	H	H	H
VII-33	H	H		H	H	H	H		H	H
VII-34		H	H	H	H		H	H	H	H
VII-35	H	H		H	H	H	H		H	H
VII-36	H	H	Ph	H	Ph	H	H	Ph	H	Ph
VII-37	H	H	Ph	Ph	H	H	H	Ph	Ph	H

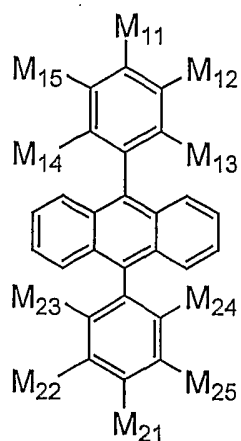

化合物 No.	M ¹¹ =M ²¹	M ¹² =M ²²	M ¹³ =M ²³	M ¹⁴ =M ²⁴	M ¹⁵ =M ²⁵
VIII'-1	H	H	H	H	H
VIII'-2	CH ₃	H	H	H	H
VIII'-3	H	CH ₃	H	H	H
VIII'-4	H	H	CH ₃	H	H
VIII'-5	Ph	H	CH ₃	CH ₃	H
VIII'-6	H	Ph	H	H	H
VIII'-7	H	H	Ph	H	H
VIII'-8	H	H	Ph	Ph	H
VIII'-9	H	H	Ph	H	Ph
VIII'-10	H	H		H	H
VIII'-11		H	H	H	H
VIII'-12	H	H		H	H
VIII'-13		H	H	H	H
VIII'-14	N(Ph) ₂	H	H	H	H
VIII'-15	N(C ₂ H ₅) ₂	H	H	H	H
VIII'-16	OCH ₃	H	H	H	H
VIII'-17	Oph	H	H	H	H
VIII'-18		H	H	H	H
VIII'-19		H	H	H	H

VIII - 1

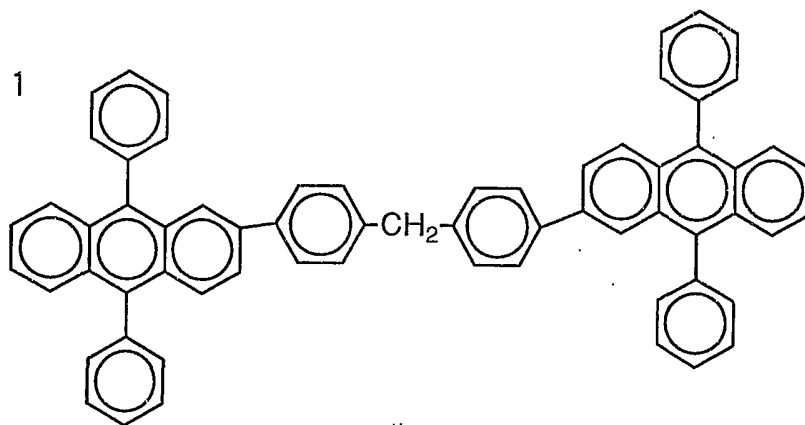

VIII - 2

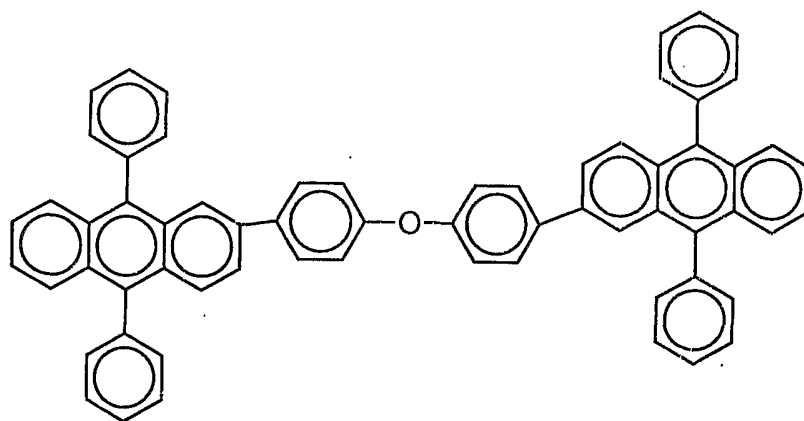

VIII - 3

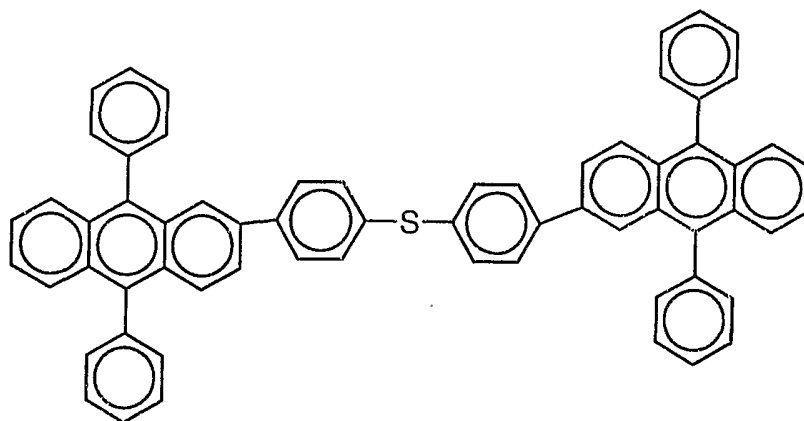

VIII - 4

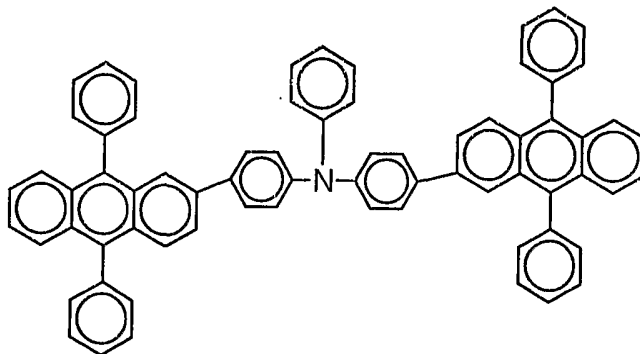

VIII - 5

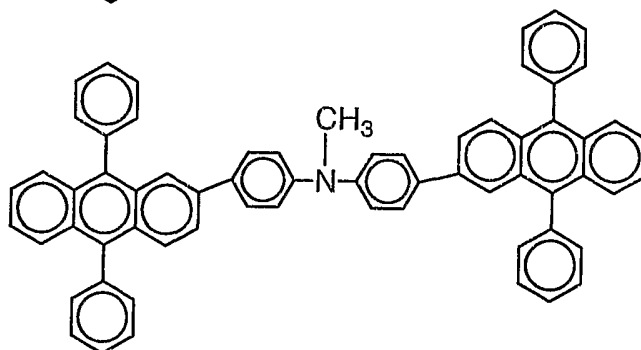

VIII - 6

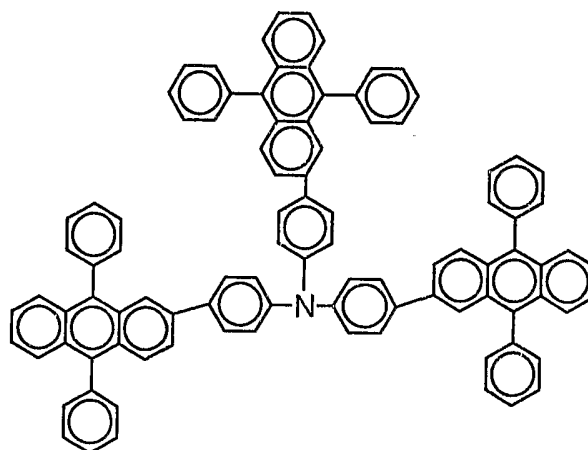

VIII - 7

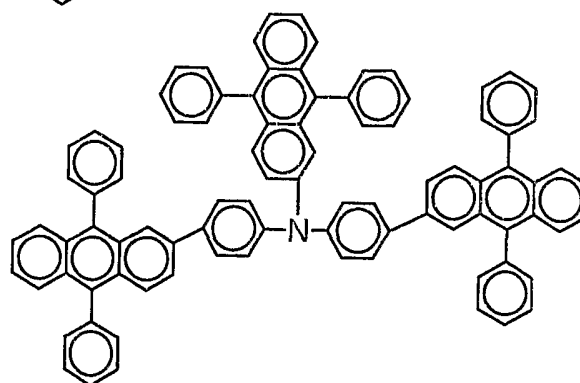

IX - 1

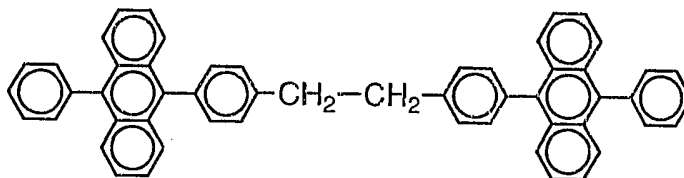

IX - 2

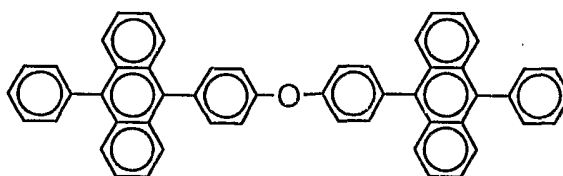

IX - 3

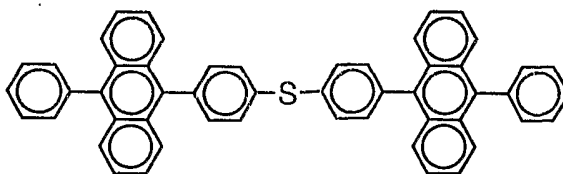

IX - 4

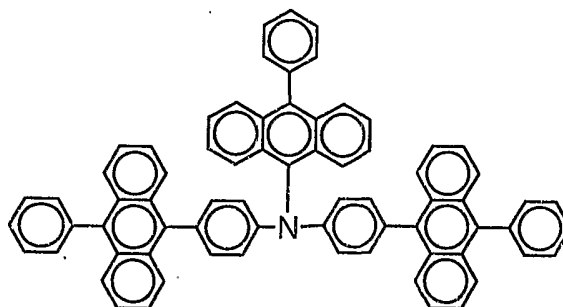

IX - 5

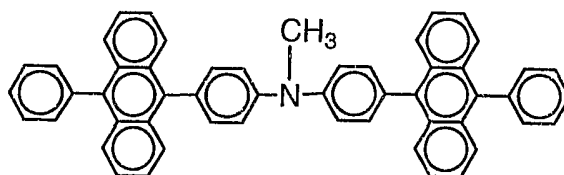

IX - 6

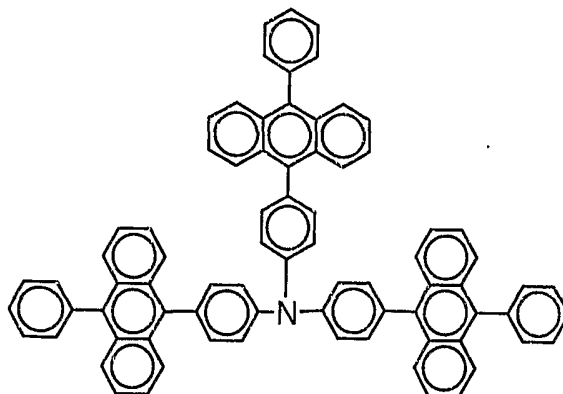

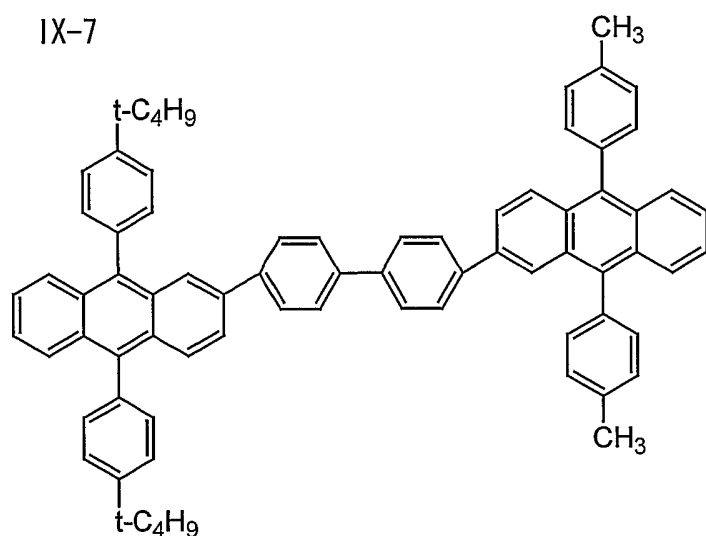

本発明に用いるフェニルアントラセン誘導体は、

- (1) ハロゲン化ジフェニルアントラセン化合物を、 $\text{Ni}(\text{cod})_2$ [cod: 1, 5-シクロオクタジエン] でカップリング、もしくはジハロゲン化アリールをグリニヤール化し $\text{NiCl}_2(\text{dpppe})$ [dpppe: ジフェニルフォスフィノエタン]、 $\text{NiCl}_2(\text{dppp})$ [dppp: ジフェニルフォスフィノプロパン]、などのNi錯体などを用いてクロスカップリングする方法、
- (2) アントラキノン、ベンゾキノン、フェニルアンスロンもしくはビアントロンとグリニヤール化したアリールもしくはリチオ化したアリールとの反応および還元によりクロスカップリングする方法、
- 等により得られる。

このようにして得られた化合物は、元素分析、質量分析、赤外吸収スペクトル、 ^1H または ^{13}C 核磁気共鳴吸収(NMR)スペクトルなどによって同定することができる。

- フェニルアントラセン誘導体は、400~2000程度、さらには400~1000程度の分子量をもち、200~500°Cの高融点を有し、80~250°C、さらには100~250°C、よりさらには130~250°C、特に150~250°Cのガラス転移温度(T_g)を示す。従って、通常の真空蒸着等により透明で

室温以上でも安定なアモルファス状態の平滑で良好な膜を形成し、しかもその良好な膜の状態が長期間に渡って維持される。

フェニルアントラセン誘導体は、比較的ニュートラルな化合物なので、発光層に用いると好ましい結果を得ることができる。また、組み合わせる発光層、電子
5 注入輸送層やホール注入輸送層のキャリア移動度やキャリア密度（イオン化ポテンシャル・電子親和力により決まる）を考慮しながら、膜厚をコントロールすることで、再結合領域・発光領域を自由に設計することが可能であり、発光色の設計や、両電極の干渉効果による発光輝度・発光スペクトルの制御や、発光の空間分布の制御を可能にできる。

10 <有機EL素子>

本発明の化合物を用いて製造される有機EL発光素子の構成例として、例えば、基板上に、ホール注入電極、ホール注入・輸送層、発光および電子注入輸送層、電子注入電極を順次有する。また、必要により電子注入電極上に補助電極や封止層を有していてもよい。

15 本発明の有機EL素子は、上記例に限らず、種々の構成とすることができ、例えば発光層を単独で設け、この発光層と電子注入電極との間に電子注入輸送層を介在させた構造とすることもできる。また、必要に応じ、ホール注入・輸送層と発光層とを混合しても良い。

20 発光層の厚さ、ホール注入輸送層の厚さおよび電子注入輸送層の厚さは特に限定されず、形成方法によっても異なるが、通常、5～500nm程度、特に10～300nmとすることが好ましい。

ホール注入輸送層の厚さおよび電子注入輸送層の厚さは、再結合・発光領域の設計によるが、発光層の厚さと同程度もしくは1/10～10倍程度とすればよい。ホールもしくは電子の、各々の注入層と輸送層を分ける場合は、注入層は1
25 nm以上、輸送層は1nm以上とするのが好ましい。このときの注入層、輸送層の

厚さの上限は、通常、注入層で500nm程度、輸送層で500nm程度である。このような膜厚については注入輸送層を2層設けるときも同じである。

ホール注入輸送層は、ホール注入電極からのホールの注入を容易にする機能、ホールを安定に輸送する機能および電子を妨げる機能を有し、電子注入輸送層は、
5 電子注入電極からの電子の注入を容易にする機能、電子を安定に輸送する機能およびホールを妨げる機能を有するものであり、これらの層は、発光層に注入されるホールや電子を増大・閉じこめさせ、再結合領域を最適化させ、発光効率を改善する。

また、ホール注入輸送層には、例えば、本発明の化合物の他に特開昭63-2
10 95695号公報、特開平2-191694号公報、特開平3-792号公報、特開平5-234681号公報、特開平5-239455号公報、特開平5-299174号公報、特開平7-126225号公報、特開平7-126226号公報、特開平8-100172号公報、EP0650955A1等に記載されている各種有機化合物を用いることができる。例えば、テトラアリアルベンジシン
15 化合物（トリアリアルジアミンないしトリフェニルジアミン：TPD）、芳香族三級アミン、ヒドラゾン誘導体、カルバゾール誘導体、トリアゾール誘導体、イミダゾール誘導体、アミノ基を有するオキサジアゾール誘導体、ポリチオフェン等である。これらの化合物は2種以上を併用してもよく、併用するときは別層にして積層したり、混合したりすればよい。

20 ホール注入輸送層をホール注入層とホール輸送層とに分けて設層する場合は、ホール注入輸送層用の化合物のなかから好ましい組合せを選択して用いることができる。このとき、ホール注入電極（ITO等）側からイオン化ポテンシャルの小さい化合物の層の順に積層することが好ましい。またホール注入電極表面には薄膜性の良好な化合物を用いることが好ましい。このような積層順については、
25 ホール注入輸送層を2層以上設けるときも同様である。このような積層順とする

ことによつて、駆動電圧が低下し、電流リークの発生やダークスポットの発生・成長を防ぐことができる。また、素子化する場合、蒸着を用いているので1~10nm程度の薄い膜も、均一かつピンホールフリーとすることができるため、ホール注入層にイオン化ポテンシャルが小さく、可視部に吸収をもつような化合物を用いても、発光色の色調変化や再吸収による効率の低下を防ぐことができる。ホール注入輸送層は、発光層等と同様に上記の化合物を蒸着することにより形成することができる。

また、電子注入輸送層には、本発明の化合物の他にトリス(8-キノリノラト)アルミニウム(AIq₃)等の8-キノリノールなしいその誘導体を配位子とする有機金属錯体などのキノリン誘導体、オキサジアゾール誘導体、ペリレン誘導体、ピリジン誘導体、ピリミジン誘導体、キノキサリン誘導体、フェナントロリン誘導体等の含窒素複素環芳香族、ジフェニルキノン誘導体、ニトロ置換フルオレン誘導体等を用いることができる。電子注入輸送層は発光層を兼ねたものであつてもよく、このような場合は本発明の発光層を使用することが好ましい。

電子注入輸送層の形成は発光層と同様に蒸着等によればよい。

電子注入輸送層を電子注入層と電子輸送層とに分けて積層する場合には、電子注入輸送層用の化合物の中から好ましい組み合わせを選択して用いることができる。このとき、電子注入電極側から電子親和力の値の大きい化合物の順に積層することが好ましい。このような積層順については電子注入輸送層を2層以上設けるときも同様である。

ホール注入輸送層、発光層および電子注入輸送層の形成には、均質な薄膜が形成できることから真空蒸着法を用いることが好ましい。真空蒸着法を用いた場合、アモルファス状態または結晶粒径が0.1μm以下の均質な薄膜が得られる。結晶粒径が0.1μmを超えていると、不均一な発光となり、素子の駆動電圧を高くしなければならなくなり、ホールの注入効率も著しく低下する。

真空蒸着の条件は特に限定されないが、 10^{-4} Pa以下の真空度とし、蒸着速度は0.01~1nm/sec程度とすることが好ましい。また、真空中で連続して各層を形成することが好ましい。真空中で連続して形成すれば、各層の界面に不純物が吸着することを防げるため、高特性が得られる。また、素子の駆動電圧

5 を低くしたり、ダークスポットの成長・発生を抑えたりすることができる。

これら各層の形成に真空蒸着法を用いる場合において、1層に複数の化合物を含有させる場合、化合物を入れた各ポートを個別に温度制御して共蒸着することが好ましい。

電子注入電極は、好ましくは仕事関数が4eV以下の金属、合金または金属間

10 化合物から構成される。仕事関数が4eVを超えると、電子の注入効率が低下し、ひいては発光効率も低下する。仕事関数が4eV以下の電子注入電極膜の構成金属としては、例えば、Li、Na、K等のアルカリ金属、Mg、Ca、Sr、Ba等のアルカリ土類金属、La、Ce等の希土類金属や、Al、In、Ag、Sn、Zn、Zr等が挙げられる。仕事関数が4eV以下の膜の構成合金としては、

15 例えばAg・Mg (Ag:0.1~50at%)、Al・Li (Li:0.01~12at%)、In・Mg (Mg:50~80at%)、Al・Ca (Ca:0.01~20at%)等が挙げられる。これらは単独で、あるいは2種以上の組み合わせとして存在してもよく、これらを2種以上組み合わせた場合の混合比は任意である。また、アルカリ金属、アルカリ土類金属、希土類金属の酸化物やハロゲン

20 化合物を薄く成膜し、アルミニウム等の支持電極(補助電極、配線電極)を用いてもよい。

この電子注入電極は蒸着法やスパッタ法等によって形成できる。

このような電子注入電極の厚さは、電子注入を十分行える一定以上の厚さとすればよく、0.1nm以上とすればよい。また、その上限値には特に制限はない

25 が、通常膜厚は0.1~500nm程度とすればよい。

ホール注入電極としては、好ましくは発光した光の透過率が80%以上となるような材料および厚さを決定することが好ましい。具体的には、酸化物透明導電薄膜が好ましく、例えば、錫ドープ酸化インジウム（ITO）、亜鉛ドープ酸化インジウム（IZO）、酸化インジウム（ In_2O_3 ）、酸化スズ（ SnO_2 ）および酸化亜鉛（ ZnO ）のいずれかを主組成としたものが好ましい。これらの酸化物はその化学量論組成から多少偏倚していてもよい。 In_2O_3 に対し SnO_2 の混合比は、1～20質量%が好ましく、さらには5～12質量%が好ましい。 In_2O_3 に対し ZnO_2 の混合比は、12～32質量%が好ましい。

ホール注入電極は、発光波長帯域、通常350～800nm、特に各発光光に対する光透過率が80%以上、特に90%以上であることが好ましい。通常、発光光はホール注入電極を通過して取り出されるため、その透過率が低くなると、発光層からの発光自体が減衰され、発光素子として必要な輝度が得られなくなる傾向がある。ただし、発光光を取り出す側が80%以上であればよい。

ホール注入電極の厚さは、ホール注入を十分行える一定以上の厚さを有すれば良く、好ましくは50～500nm、さらには50～300nmの範囲が好ましい。また、その上限は特に制限はないが、あまり厚いと剥離などの心配が生じる。厚さが薄すぎると、製造時の膜強度やホール輸送能力、抵抗値の点で問題がある。

ホール注入電極を成膜するにはスパッタ法が好ましい。スパッタ法としてはRF電源を用いた高周波スパッタ法等も可能であるが、成膜するホール注入電極の膜物性の制御のし易さや、成膜面の平滑度等を考慮するとDCスパッタ法を用いることが好ましい。

また、必要に応じて保護膜を形成してもよい。保護膜は SiO_x 等の無機材料、テフロン（登録商標）等の有機材料等を用いて形成することができる。保護膜は透明でも不透明であってもよく、保護膜の厚さは50～1200nm程度とする。保護膜は前記した反応性スパッタ法の他に、一般的なスパッタ法、蒸着法等によ

り形成すればよい。

さらに、素子の有機層や電極の酸化を防ぐために素子上に封止層を設けることが好ましい。封止層は、湿気の侵入を防ぐために市販の低吸湿性の光硬化性接着剤、エポキシ系接着剤、シリコーン系接着剤、架橋エチレン-酢酸ビニル共重合体接着剤シート等の接着性樹脂層を用いて、ガラス板等の封止板を接着し密封する。ガラス板以外にも金属板、プラスチック板等を用いることもできる。

基板材料としては、基板側から発光した光を取り出す構成の場合、ガラスや石英、樹脂等の透明ないし半透明材料を用いる。また、基板に色フィルター膜や蛍光性物質を含む色変換膜、あるいは誘電体反射膜を用いて発光色をコントロールしてもよい。また、前記逆積層の場合には、基板は透明でも不透明であってもよく、不透明である場合にはセラミックス等を使用してもよい。

カラーフィルター膜には、液晶ディスプレイ等で用いられているカラーフィルターを用いれば良いが、有機ELの発光する光に合わせてカラーフィルターの特性を調整し、取り出し効率・色純度を最適化すればよい。

また、EL素子材料や蛍光変換層が光吸収するような短波長の外光をカットできるカラーフィルターを用いれば、素子の耐光性・表示のコントラストも向上する。

また、誘電体多層膜のような光学薄膜を用いてカラーフィルターの代わりにしても良い。

本発明の有機EL素子は、例えば図1に示すように、基板1上にホール注入電極（陽極）2，ホール注入輸送層3，発光層4，電子注入輸送層5，電子注入電極（陰極）6が順次積層された構成を有する。また、この積層順とは逆の構成としてもよいし、ホール注入輸送層3、電子注入輸送層5を省略したり、発光層4と兼用させてもよい。これらの構成層は求められる素子の機能等により最適なものに調整すればよい。

本発明の有機EL素子は、通常、直流駆動型、パルス駆動型のEL素子として用いられるが、交流駆動とすることもできる。印加電圧は、通常、2～30V程度とされる。

5 実施例

以下、本発明の具体的実施例を比較例とともに示し、本発明をさらに詳細に説明する。

<合成例1>

3・ブロモ・7、12ジフェニルベンゾ[k]フルオランテンの合成

- 10 ジフェニルイソベンゾフラン5g(18.5mmol)と5・ブロモアセナフチレン4.3g(18.5mmol)をトルエン中、還流温度で24時間攪拌した。溶媒を減圧留去後、酢酸500mlに溶解させた。そこへ40%の臭素酸水溶液50cm³を加えて80°Cで1時間過熱した。室温まで冷却後、沈殿物を濾別し、トルエン、ヘキサンを混合溶媒を抽出溶媒としてシリカゲルクロマトグラフィーにより精製し、黄白色の3・
- 15 ブロモ・7、12ジフェニルベンゾ[k]フルオランテン7gを得た。

<合成例2>

7、12ジフェニルベンゾ[k]フルオランテノ・3・ボロン酸の合成

- 3・ブロモ・7、12ジフェニルベンゾ[k]フルオランテン2.5gを50cm³のTHFに溶解させ、-40°Cに冷却した。そこへブチルリリウムのヘキサン溶液(1.5mol/l)5cm³をくわえて2時間反応させた。そこへホウ酸トリエチル1.5gを加えて
- 20 1時間反応させた。室温に戻した後、5Nの塩酸水溶液15cm³を加えたあと、炭酸水素ナトリウムで中和した。THFを留去後、固形物を濾別した。濾物を蒸留水で洗浄後、再沈澱により精製し、2gのボロン酸を得た。

<合成例3>

- 25 例示化合物A・2の合成

先に調製したボロン酸2g (4.5mmol) とp-ジブロモベンゼン0.33g (1.4mmol) を50cm³ のジメトキシエタンに溶解させ、80°Cに過熱した。そこへ蒸留水50 cm³ および炭酸ナトリウム10gを投入した。さらにそこへテトラキストリフェニルホスフィンパラジウム (0) 0.2g投入した。

- 5 3時間後沈殿している目的物を回収した。精製はシリカゲルクロマトグラフィーを用い、黄白色結晶1gを得た。

得られた化合物はマススペクトル、赤外線吸収スペクトル、NMRを用いて同定した。

	マススペクトル	m/e=883 (M+1)+ 図 2
10	赤外線吸収スペクトル	図 3
	NMR	図 4
	ガラス転位温度 (T _g)	251°C

<合成例 4 >

例示化合物V・2の合成

- 15 先に合成したボロン酸2g (4.5mmol) とビス-p-ジブロモトリフェニルアミン0.56g (1.4mmol) を50cm³ のジメトキシエタンに溶解させ、80°Cに過熱した。そこへ蒸留水50cm³ および炭酸ナトリウム10gを投入した。さらにそこへテトラキストリフェニルホスフィンパラジウム (0) 0.2g投入した。

- 20 3時間後沈殿している目的物を回収した。精製はシリカゲルクロマトグラフィーを用い、黄色結晶1gを得た。

得られた化合物はマススペクトル、赤外線吸収スペクトル、NMRを用いて同定した。

	マススペクトル	m/e=1050 (M+1)+
--	---------	-----------------

例示化合物Z・2の合成

- 25 キシレン50cm³ 中に先に合成した3・ブロモ・7, 12ジフェニルベンゾ[k]フル

オランテン2g (4.1mmol) とアニリン0.13g (1.4mmol) を溶解させた。そこへトリスジベンジリデンアセトンパラジウム (0) 0.2gとトリ・t・ブチルホスフィン 0.5cm³ を加えて130°Cで12時間反応させた。

- 5 沈澱している目的物を回収して、シリカゲルクロマトグラフィーにより精製し、黄色結晶1gを得た。

得られた化合物はマススペクトル、赤外線吸収スペクトル、NMRを用いて同定した。

マススペクトル $m/e=898 (M+1)^+$

<実施例 1>

- 10 ガラス基板上にRFスパッタ法で、ITO透明電極薄膜を100nmの厚さに成膜し、パターニングした。このITO透明電極付きガラス基板を、中性洗剤、アセトン、エタノールを用いて超音波洗浄し、煮沸エタノール中から引き上げて乾燥した。透明電極表面をUV/O₃洗浄した後、真空蒸着装置の基板ホルダーに固定して、槽内を 1×10^{-4} Pa以下まで減圧した。
- 15 次いで減圧状態を保ったまま、下記構造のN, N'-ジフェニルーN, N'-ビス [N-(4-メチルフェニル) -N-フェニルー(4-アミノフェニル)] -1, 1'-ビフェニルー4, 4'-ジアミンを蒸着速度0.1nm/secで100nmの膜厚に蒸着し、ホール注入層とした。

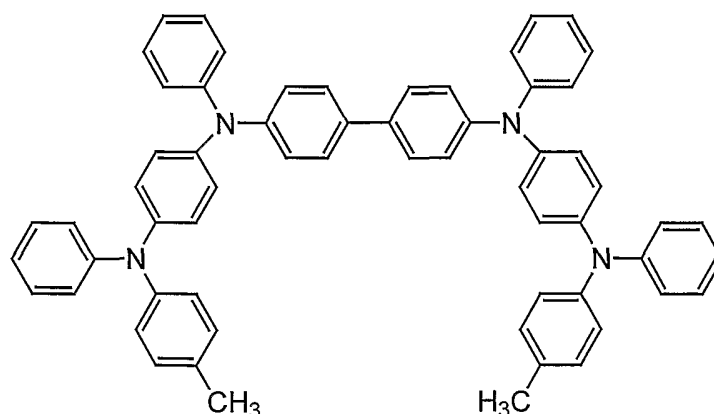

次いで、下記構造のN, N, N', N' -テトラキス (m-ビフェニル) -1, 1' -ビフェニル-4, 4' -ジアミンを蒸着速度0.1 nm/secで10 nmの厚さに蒸着し、ホール輸送層とした。

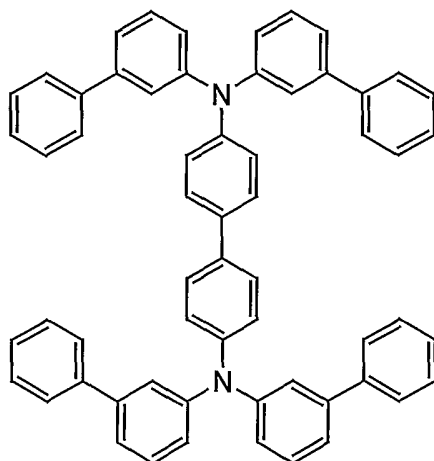

- 5 さらに、減圧を保ったまま、下記構造のアントラセン系ホスト材料と、本発明化合物 (A-2) のドーパントを、質量比98 : 2で、全体の蒸着速度0.1 nm/secとして40 nmの厚さに蒸着し発光層とした。

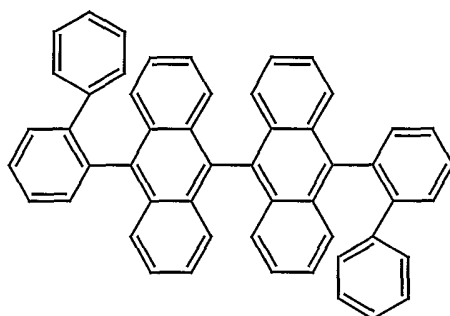

アントラセン系化合物

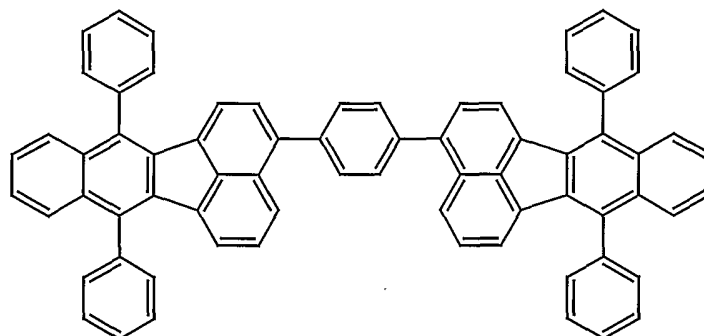

本発明化合物(A-2)

次いで、減圧状態を保ったまま、トリス(8-ヒドロキシキノリン)アルミニウム(AIq3)を、蒸着速度0.1nm/secで15nmの厚さに蒸着し、電子注入輸送層とした。

- 5 次いで、LiFを蒸着速度0.1nm/secで0.5nmの厚さに蒸着し、電子注入電極とし、保護電極としてAlを100nm蒸着し、最後にガラス封止して有機EL素子を得た。

この有機EL素子に直流電圧を印加し、初期には10mA/cm²の電流密度で、駆動電圧が8.6V、730cd/m²以上の発光が確認できた。このときのピーク波長は450nm、色度座標は(x、y)=(0.15, 0.11)であった。
10 この素子に、10mA/cm²の一定電流を流し、連続駆動したところ、初期輝度730cd/m²以上で、輝度半減時間は500時間以上であった。従って、輝度cd×半減時間hは365000であった。図5に発光スペクトルを示す。

<実施例2>

実施例1において、N, N'-ジフェニル-N, N'-ビス [N-(4-メチルフェニル)-N-フェニル-(4-アミノフェニル)]-1, 1'-ビフェニル-4, 4'-ジアミンを蒸着速度0.1nm/secで50nmの膜厚に蒸着し、
5 ホール注入層とした。

次いで、N, N, N', N'-テトラキス(m-ピフェニル)-1, 1'-ビフェニル-4, 4'-ジアミンを宿主材料にして、本発明化合物(A-2)のドーパントを、質量比98:2で、全体の蒸着速度0.1nm/secとして30nmの厚さに蒸着し、ホール輸送層兼発光層とした。

10 次いで、減圧状態を保ったまま、トリス(8-ヒドロキシキノリン)アルミニウム(A1q3)を、蒸着速度0.1nm/secで40nmの厚さに蒸着し、電子注入輸送層とした。

次いで、LiFを蒸着速度0.1nm/secで0.3nmの厚さに蒸着し、電子注入電極とし、保護電極としてAlを200nm蒸着し、最後にガラス封止して有機EL素子を得た。
15

得られた有機EL素子に直流電圧を印加し、初期には10mA/cm²の電流密度で、駆動電圧が7.9V、780cd/m²以上の発光が確認できた。このときのピーク波長は450nm、色度座標は(x, y) = (0.15, 0.11)であった。この素子に、10mA/cm²の一定電流を流し、連続駆動したところ、
20 初期輝度780cd/m²以上で、輝度半減時間は400時間以上であった。

<実施例3>

実施例1において、N, N'-ジフェニル-N, N'-ビス [N-(4-メチルフェニル)-N-フェニル-(4-アミノフェニル)]-1, 1'-ビフェニル-4, 4'-ジアミンを蒸着速度0.1nm/secで50nmの膜厚に蒸着し、
25 ホール注入層とした。

次いで、N, N, N', N' -テトラキス (m-ビフェニル) -1, 1' -ビフェニル-4, 4' -ジアミンを蒸着速度0. 1 nm/secで20 nmの厚さに蒸着し、ホール輸送層とした。

さらに、減圧を保ったまま、実施例1の本発明化合物 (A-2) をホスト材料
5 とし、下記構造のナフタセン系化合物ドーパントを、質量比98 : 2で、全体の蒸着速度0. 1 nm/secとして40 nmの厚さに蒸着し発光層とした。

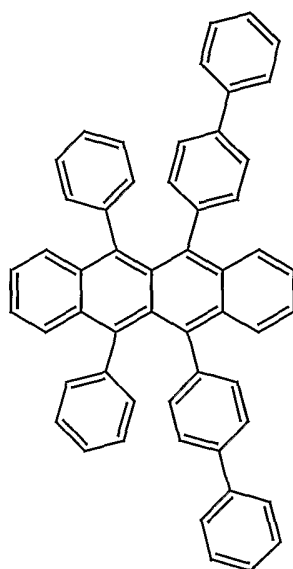

次いで、減圧状態を保ったまま、トリス (8-ヒドロキシキノリン) アルミニウム (Alq3) を、蒸着速度0. 1 nm/secで30 nmの厚さに蒸着し、電子注
10 入輸送層とした。

次いで、LiFを蒸着速度0. 1 nm/secで0. 3 nmの厚さに蒸着し、電子注入電極とし、保護電極としてAlを150 nm蒸着し、最後にガラス封止して有機EL素子を得た。

得られた有機EL素子に直流電圧を印加し、初期には10 mA/cm² の電流密度で、駆動電圧が6. 3 V、900 cd/m² 以上の発光が確認できた。このときのピーク波長は560 nm、色度座標は (x, y) = (0. 45, 0. 55) で
15 あった。この素子に、10 mA/cm² の一定電流を流し、連続駆動したところ、

初期輝度 900 cd/m^2 以上で、輝度半減時間は 3000 時間以上であった。

<実施例 4>

実施例 3 において、発光層のドーパントを下記構造のナフタセン系化合物に代えた以外は実施例 3 と同様にして有機 EL 素子を得た。

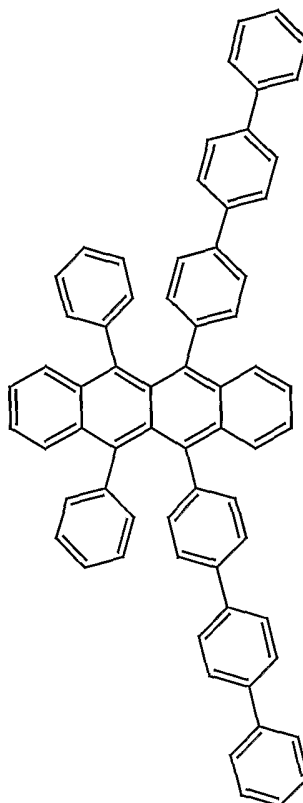

5

得られた有機 EL 素子に直流電圧を印加し、初期には 10 mA/cm^2 の電流密度で、駆動電圧が 6.3 V 、 910 cd/m^2 以上の発光が確認できた。このときのピーク波長は 560 nm 、色度座標は $(x, y) = (0.45, 0.55)$ であった。この素子に、 10 mA/cm^2 の一定電流を流し、連続駆動したところ、

10 初期輝度 910 cd/m^2 以上で、輝度半減時間は 3000 時間以上であった。

<実施例 5>

実施例 3 において、発光層のドーパントを下記構造の化合物に代えた以外は実施例 3 と同様にして有機 EL 素子を得た。

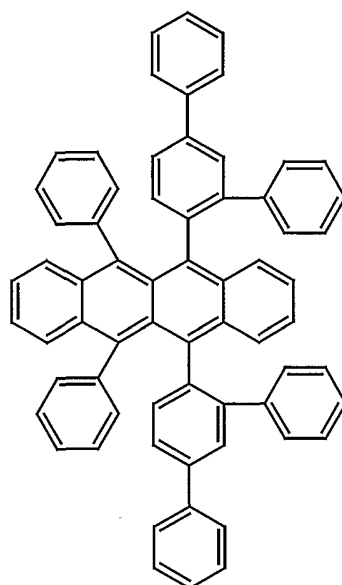

得られた有機EL素子に直流電圧を印加し、初期には 10 mA/cm^2 の電流密度で、駆動電圧が 6.5 V 、 750 cd/m^2 以上の発光が確認できた。このときのピーク波長は 580 nm 、色度座標は $(x, y) = (0.52, 0.48)$ であった。この素子に、 10 mA/cm^2 の一定電流を流し、連続駆動したところ、初期輝度 750 cd/m^2 以上で、輝度半減時間は 3000 時間以上であった。

<実施例6>

実施例3において、発光層のドーパントを下記構造の化合物に代えた以外は実施例3と同様にして有機EL素子を得た。

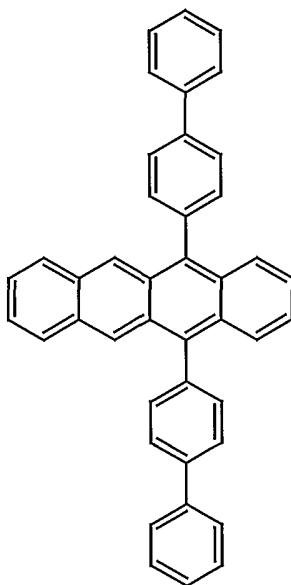

得られた有機EL素子に直流電圧を印加し、初期には 10 mA/cm^2 の電流密度で、駆動電圧が 6.6 V 、 1100 cd/m^2 以上の発光が確認できた。このときのピーク波長は 515 nm 、色度座標は $(x, y) = (0.30, 0.65)$ であった。この素子に、 10 mA/cm^2 の一定電流を流し、連続駆動したところ、初期輝度 1100 cd/m^2 以上で、輝度半減時間は 3000 時間以上であった。

<実施例7>

実施例3において、ドーパントを下記構造の化合物に代えた以外は実施例3と同様にして有機EL素子を得た。

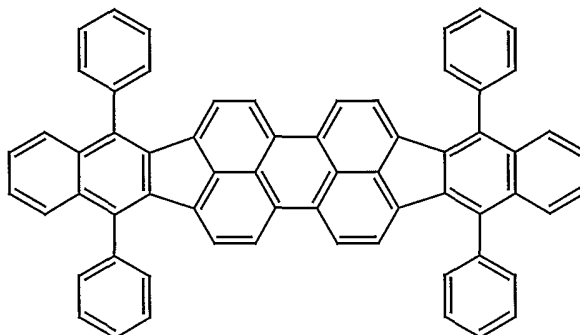

10

得られた有機EL素子に直流電圧を印加し、初期には 10 mA/cm^2 の電流密度で、駆動電圧が 6.5 V 、 550 cd/m^2 以上の発光が確認できた。このとき

のピーク波長は610nm、色度座標は $(x, y) = (0.65, 0.35)$ であった。この素子に、 $10\text{mA}/\text{cm}^2$ の一定電流を流し、連続駆動したところ、初期輝度 $550\text{cd}/\text{m}^2$ 以上で、輝度半減時間は5000時間以上であった。

<実施例8>

- 5 実施例1において、N, N'-ジフェニル-N, N'-ビス [N-(4-メチルフェニル)-N-フェニル-(4-アミノフェニル)]-1, 1'-ビフェニル-4, 4'-ジアミンを蒸着速度 $0.1\text{nm}/\text{sec}$ で50nmの膜厚に蒸着し、ホール注入層とした。

- 10 次いで、N, N, N', N'-テトラキス(m-ビフェニル)-1, 1'-ビフェニル-4, 4'-ジアミンを蒸着速度 $0.1\text{nm}/\text{sec}$ で20nmの厚さに蒸着し、第1のホール輸送層とした。

さらに、減圧を保ったまま、実施例1の本発明化合物(A-2)を蒸着速度 $0.1\text{nm}/\text{sec}$ として10nmの厚さに蒸着し、第2のホール輸送層とした。

次いで、下記構造の化合物をホスト材料とし、

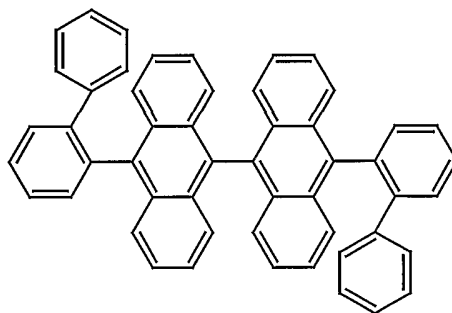

15

下記構造の化合物ドーパントを、質量比98:2で、全体の蒸着速度 $0.1\text{nm}/\text{sec}$ として40nmの厚さに蒸着し発光層とした。

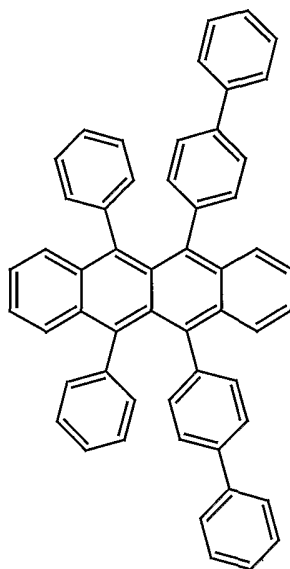

次いで、減圧状態を保ったまま、トリス（8-ヒドロキシキノリン）アルミニウム（Alq₃）を、蒸着速度0.1nm/secで30nmの厚さに蒸着し、電子注入輸送層とした。

- 5 次いで、LiFを蒸着速度0.1nm/secで0.3nmの厚さに蒸着し、電子注入電極とし、保護電極としてAlを150nm蒸着し、最後にガラス封止して有機EL素子を得た。

得られた有機EL素子に直流電圧を印加し、初期には10mA/cm²の電流密度で、駆動電圧が6.0V、820cd/m²以上の発光が確認できた。このとき
10 のピーク波長は556nm、色度座標は(x、y) = (0.45, 0.55)であった。

<実施例9>

実施例1において、N, N'-ジフェニル-N, N'-ビス [N-(4-メチルフェニル)-N-フェニル-(4-アミノフェニル)]-1, 1'-ビフェニル-4, 4'-ジアミンを蒸着速度0.1nm/secで90nmの膜厚に蒸着し、
15 ホール注入層とした。

次いで、N, N, N', N'-テトラキス(m-ビフェニル)-1, 1'-ビ

フェニル-4, 4'-ジアミンを蒸着速度0.1 nm/secで10 nmの厚さに蒸着し、ホール輸送層とした。

さらに、減圧を保ったまま、本発明化合物(A-2)を蒸着速度0.1 nm/secとして10 nmの厚さに蒸着し、第2のホール輸送層とした。

5 次いで、実施例8の化合物をホスト材料とし、本発明の化合物(A-2)ドープメントを、質量比98:2で、全体の蒸着速度0.1 nm/secとして40 nmの厚さに蒸着し発光層とした。

次いで、減圧状態を保ったまま、トリス(8-ヒドロキシキノリン)アルミニウム(AIq3)を、蒸着速度0.1 nm/secで15 nmの厚さに蒸着し、電子注
10 入輸送層とした。

次いで、LiFを蒸着速度0.1 nm/secで0.5 nmの厚さに蒸着し、電子注入電極とし、保護電極としてAlを100 nm蒸着し、最後にガラス封止して有機EL素子を得た。

得られた有機EL素子に直流電圧を印加し、初期には10 mA/cm²の電流密度で、駆動電圧が8.0 V、700 cd/m²以上の発光が確認できた。このとき
15 のピーク波長は450 nm、色度座標は(x, y) = (0.15, 0.11)であった。この素子に、10 mA/cm²の一定電流を流し、連続駆動したところ、初期輝度700 cd/m²以上で、輝度半減時間は1000時間以上であった。

<実施例10>

20 実施例1において、N, N'-ジフェニル-N, N'-ビス[N-(4-メチルフェニル)-N-フェニル-(4-アミノフェニル)]-1, 1'-ビフェニル-4, 4'-ジアミンを蒸着速度0.1 nm/secで10 nmの膜厚に蒸着し、ホール注入層とした。

次いで、N, N, N', N'-テトラキス(m-ビフェニル)-1, 1'-ビ
25 フェニル-4, 4'-ジアミンを蒸着速度0.1 nm/secで20 nmの厚さに蒸着

し、ホール輸送層とした。

次いで、N, N, N', N' -テトラキス (m-ビフェニル) -1, 1' -ビフェニル-4, 4' -ジアミンと、化70の化合物、および化69の化合物をドーパントとして、それぞれ質量比49 : 49 : 2で、全体の蒸着速度0.1 nm/secとして15 nmの厚さに蒸着し第1の発光層 (赤色) とした。

次いで、N, N, N', N' -テトラキス (m-ビフェニル) -1, 1' -ビフェニル-4, 4' -ジアミンと、化70の化合物、および化68の化合物をドーパントとして、それぞれ質量比49 : 49 : 2で、全体の蒸着速度0.1 nm/secとして20 nmの厚さに蒸着し第2の発光層 (緑色) とした。

さらに、N, N, N', N' -テトラキス (m-ビフェニル) -1, 1' -ビフェニル-4, 4' -ジアミンと、化70の化合物、および本発明の化合物 (A-2) をドーパントとして、それぞれ質量比49 : 49 : 2で、全体の蒸着速度0.1 nm/secとして20 nmの厚さに蒸着し第2の発光層 (青色) とした。

その他は実施例1と同様にして有機EL素子を得た。

得られた有機EL素子に直流電圧を印加し、初期には10 mA/cm² の電流密度で、駆動電圧が8.5 V、750 cd/m² 以上の発光が確認できた。全体の発光色は色度座標で (x, y) = (0.30, 0.33) となり、ほぼ白色に近い色調が得られた。

[実施例11]

実施例1において、発光層のドーパントを下記構造 (Type BBB-9) に代えた以外は実施例1と同様にして有機EL素子を得た。

5

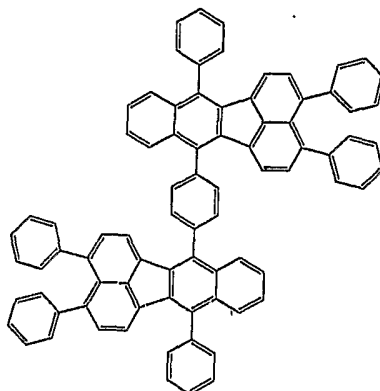

TypeBBB-9

この有機EL素子に直流電圧を印加し、初期には10 mA/cm² の電流密度で、
 10 駆動電圧が8.6V、800 cd/m² 以上の発光が確認できた。この時のピーク波長は452nm、色度座標は(x, y) = (0.15, 0.11)であった。

この素子に10 mA/cm² の一定電流を流し、連続駆動したところ、初期800 cd/m² 以上で輝度半減時間は1200時間以上であった。従って、輝度cd×半減時間は960000であった。図6に発光スペクトルを示す。

15 [実施例12]

実施例1において、発光層のドーパントを下記構造(TypeV-2)に代えた以外は実施例1と同様にして有機EL素子を得た。

20

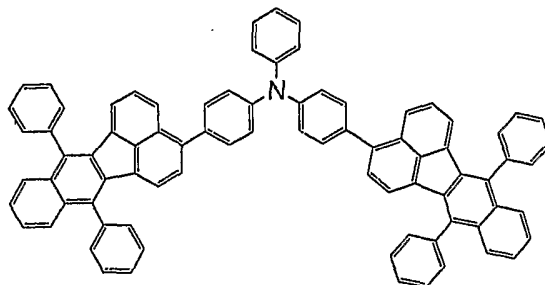

TypeV-2

この有機EL素子に直流電圧を印加し、初期には10 mA/cm² の電流密度で、
 駆動電圧が8.6 V、900 cd/m² 以上の発光が確認できた。この時のピーク
 波長は473 nm、色度座標は(x, y) = (0.14, 0.27)であった。

この素子に50 mA/cm² 一定電流を流し、連続駆動したところ、初期4500
 5 cd/m² 以上で、輝度半減時間は500時間以上であった。従って、輝度cd×半
 減時間は22500000であった。図7に発光スペクトルを示す。

〔実施例13〕

実施例1において発光層のドーパントを下記構造(Type Z-2)に代えた以
 外は実施例1と同様にして有機EL素子を得た。

10

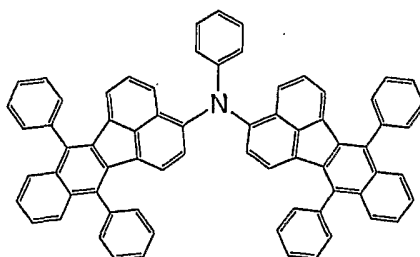

15

TypeZ-2

この有機EL素子に直流電圧を印加し、初期には10 mA/cm² 電流密度で、駆
 動電圧が8.6 V、1100 cd/m² 以上の発光が確認できた。この時のピーク
 20 波長は518 nm、色度座標は(x, y) = (0.28, 0.61)であった。

この素子に、50 mA/cm² の一定電流を流し、連続駆動したところ、初期55
 00 cd/m² 以上で、輝度半減時間は500時間以上であった。従って、輝度cd
 ×半減時間は27500000であった。図8に発光スペクトルを示す。

<比較例1>

25 実施例1において、発光層にドーパントをドーピングしない以外は実施例1と

同様にして有機EL素子を得た。

- この有機EL素子に直流電圧を印加したところ、初期には 10 mA/cm^2 の電流密度で、駆動電圧が 6.5 V 、 180 cd/m^2 以下となってしまった。このときのピーク波長は 440 nm 、色度座標は $(x, y) = (0.16, 0.07)$ であった。この素子に、 10 mA/cm^2 の一定電流を流し、連続駆動したところ、初期輝度 180 cd/m^2 で、輝度半減時間は 250 時間以下となった。従って、輝度 $\text{cd} \times$ 半減時間 h は 4500 であった。このことから、実施例1の素子は、この素子に比べて4倍以上の輝度で発光することが可能であり、同一発光輝度で8倍以上長寿命であることがわかる。

10 <比較例2>

実施例1において、発光層のドーパントを下記構造の化合物とした以外は実施例1と同様にして有機EL素子を得た。

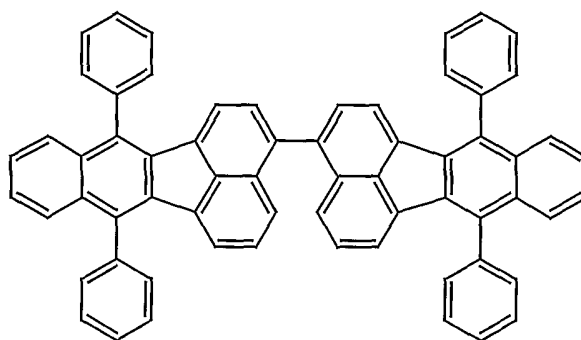

- この有機EL素子に直流電圧を印加したところ、初期には 10 mA/cm^2 の電流密度で、駆動電圧が 6.6 V 、 700 cd/m^2 であった。このときのピーク波長は 465 nm 、色度座標は $(x, y) = (0.20, 0.20)$ と青色から長波長側に外れた発光色となった。この素子に、 10 mA/cm^2 の一定電流を流し、連続駆動したところ、初期輝度 700 cd/m^2 で、輝度半減時間は 500 時間であった。

20 <比較例3>

実施例 1 において、発光層のドーパントを下記構造の化合物とした以外は実施例 1 と同様にして有機 EL 素子を得た。

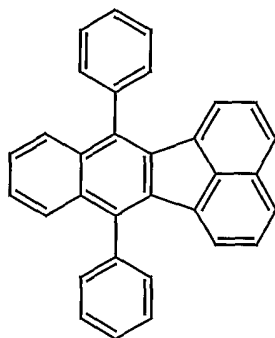

この有機 EL 素子に直流電圧を印加したところ、初期には 10 mA/cm^2 の電
5 流密度で、駆動電圧が 6.5 V 、 180 cd/m^2 であった。このときのピーク波
長は 440 nm 、色度座標は $(x, y) = (0.16, 0.07)$ となった。こ
の素子に、 10 mA/cm^2 の一定電流を流し、連続駆動したところ、初期輝度 180 cd/m^2 で、輝度半減時間は 250 時間であった。

10 発明の効果

以上のように本発明によれば、十分な輝度の発光、特に長波長における発光が得られ、優れた色純度、特にフルカラーディスプレイに用いるのに十分な色純度が得られ、かつ良好な発光性能が長期にわたって持続する耐久性に優れた有機 EL 素子用化合物、および有機 EL 素子を提供することができる。

請求の範囲

1. 下記式(1)で表される基本骨格を有する有機EL素子用化合物。



5 [式(1)中、Xは下記式(2)で表される化合物を表し、同一であっても異なってもよい。Yは単結合もしくは置換または非置換のアリール基、または複素環基からなる連結基を表し、nは2または3の整数を表す。]

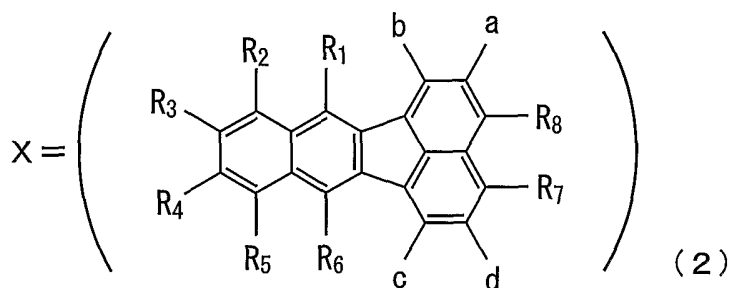

10 [式(2)中、R₁ ~ R₈ および a ~ d は水素、アルキル基、置換基を有していてもよいアリール基、置換基を有していてもよいアリル基、置換基を有していてもよい複素環基、アミノ基、または置換基を有していてもよいアリールアミノ基のいずれかを表す。]

2. 前記Yは下記化合物より選択される1種である請求の範囲第1項の有機EL素子用化合物。

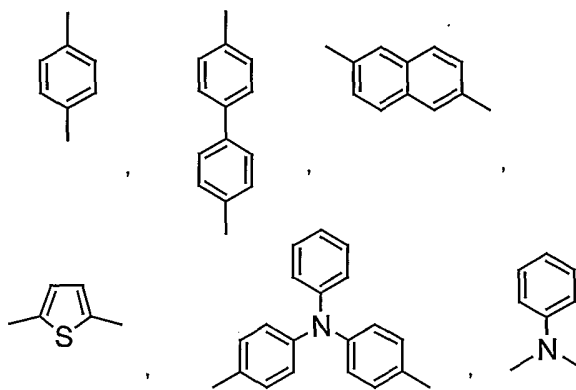

15

3. 前記nは2である請求の範囲第1項の有機EL素子用化合物。

4. ドーパントとして用いられる請求の範囲第1項の有機EL素子用化合物。
5. 電子輸送材料である請求の範囲第1項の有機EL素子用化合物。
6. ホール注入または輸送材料である請求の範囲第1項の有機EL素子用化合物。
7. 下記式(3a)で表される基本骨格を有する請求の範囲第1項の有機EL素子用化合物。

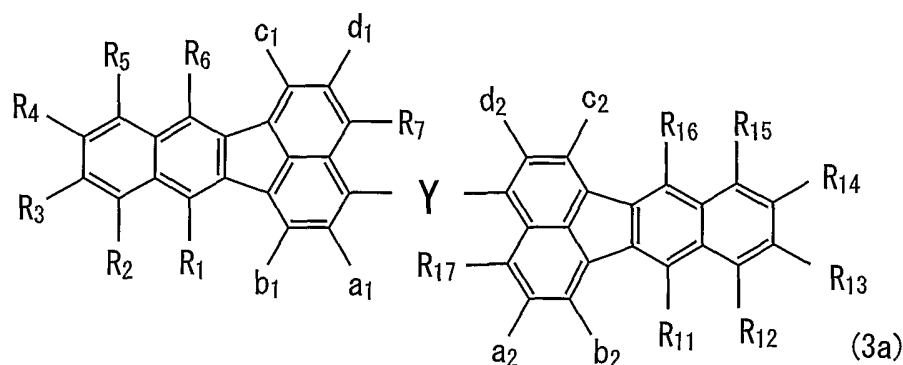

- [式(3a)中、 $R_1 \sim R_8$ および $a_1 \sim d_1$ 、 $R_{11} \sim R_{18}$ および $a_2 \sim d_2$ は、水素、アルキル基、置換基を有していてもよいアリール基、置換基を有していてもよいアリル基、置換基を有していてもよい複素環基、アミノ基、置換基を有していてもよいアリールアミノ基のいずれかを表す。Yは置換または非置換のフェニレン、ビフェニレン、ナフタセン、ペリレン、ピレン、フェナントレン、チオフェン、ピリジン、ピラジン、トリアジン、アミン、トリアリールアミン、ピロール誘導体、チアゾール、チアジアゾール、フェナントロリン、キノリン、およびキノキサリンのいずれかからなる連結基を表す。]

8. 下記式(3b)で表される基本骨格を有する請求の範囲第1項の有機EL素子用化合物。

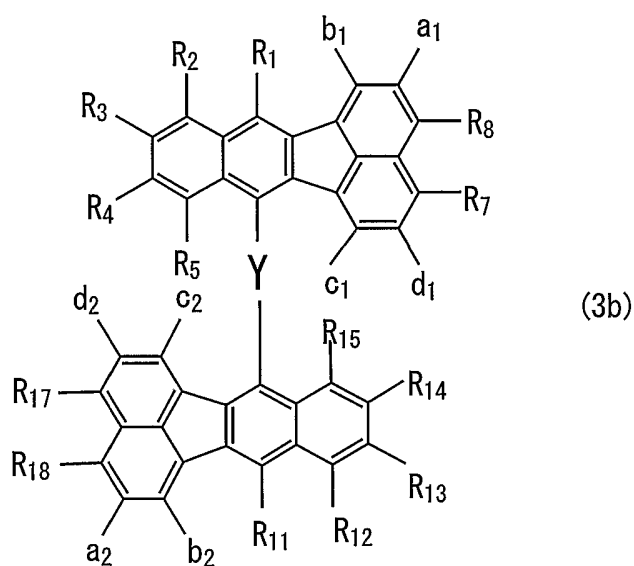

[式(3b)中、 $R_1 \sim R_8$ および $a_1 \sim d_1$ 、 $R_{11} \sim R_{18}$ および $a_2 \sim d_2$ は、水素、アルキル基、置換基を有していてもよいアリール基、置換基を有していてもよいアリル基、置換基を有していてもよい複素環基、アミノ基、置換基を有していてもよいアリールアミノ基のいずれかを表す。Yは単結合、置換または非置換のアリール基、あるいは複素環基からなる連結基を表す。]

9. 下記式(3c)で表される基本骨格を有する請求の範囲第1項の有機EL素子用化合物。

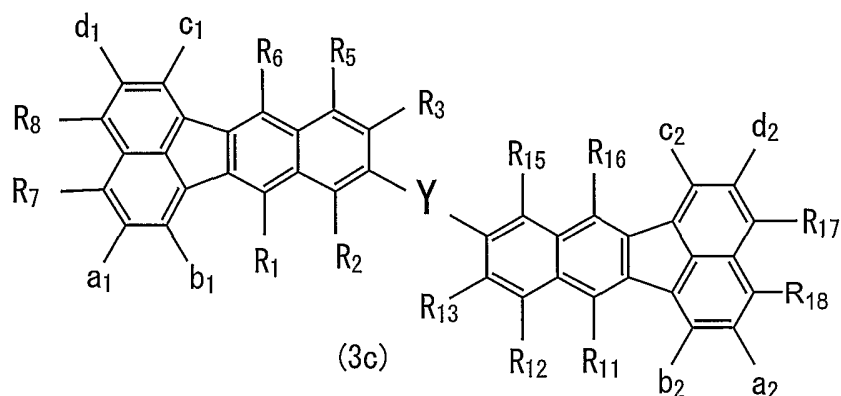

10 [式(3c)中、 $R_1 \sim R_8$ および $a_1 \sim d_1$ 、 $R_{11} \sim R_{18}$ および $a_2 \sim d_2$ は、水素、アルキル基、置換基を有していてもよいアリール基、置換基を有していてもよいアリル基、置換基を有していてもよい複素環基、アミノ基、置換基を

有していてもよいアリールアミノ基のいずれかを表す。Yは単結合、置換または非置換のアリール基、あるいは複素環基からなる連結基を表す。]

10. 下記式(A)で表される基本骨格を有する請求の範囲第1項の有機EL素子用化合物。

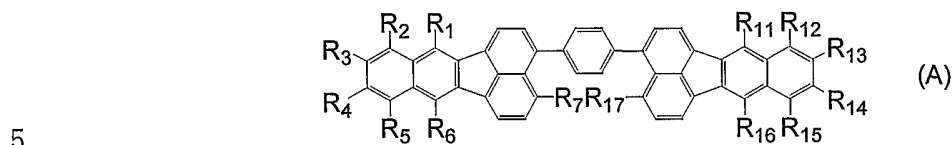

[式(A)中、R₁ ~ R₇ およびR₁₁ ~ R₁₇ は、水素、アルキル基、置換または非置換のアリール基、あるいは複素環基を表す。]

11. 下記式(B)で表される基本骨格を有する請求の範囲第1項の有機EL素子用化合物。

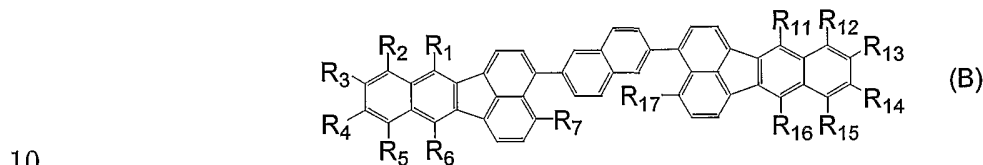

[式(B)中、R₁ ~ R₇ およびR₁₁ ~ R₁₇ は、水素、アルキル基、置換または非置換のアリール基、あるいは複素環基を表す。]

12. 下記式(E)で表される基本骨格を有する請求の範囲第1項の有機EL素子用化合物。

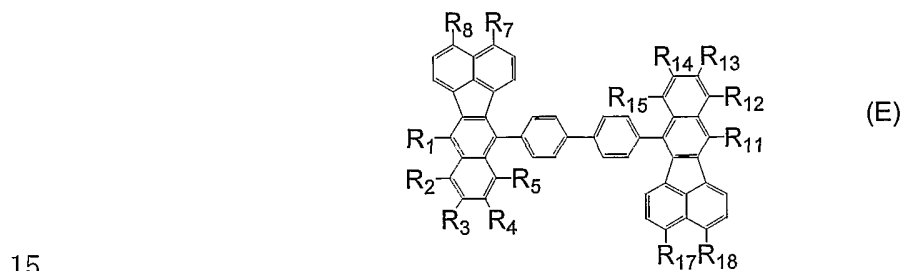

[式(E)中、R₁ ~ R₈ およびR₁₁ ~ R₁₈ は、水素、アルキル基、置換また

は非置換のアリール基、あるいは複素環基を表す。]

13. 下記式 (H) で表される基本骨格を有する請求の範囲第 1 項の有機 EL 素子用化合物。

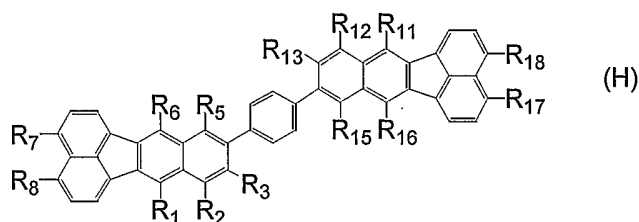

5 [式 (H) 中、 $R_1 \sim R_8$ および $R_{11} \sim R_{18}$ は、水素、アルキル基、置換または非置換のアリール基、あるいは複素環基を表す。]

14. 下記式 (X) で表される基本骨格を有する請求の範囲第 1 項の有機 EL 素子用化合物。

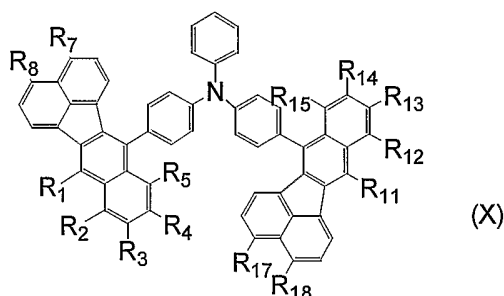

10 [式 (X) 中、 $R_1 \sim R_8$ および $R_{11} \sim R_{18}$ は、水素、アルキル基、置換または非置換のアリール基、あるいは複素環基を表す。]

15. 下記式 (Z) で表される基本骨格を有する請求の範囲第 1 項の有機 EL 素子用化合物。

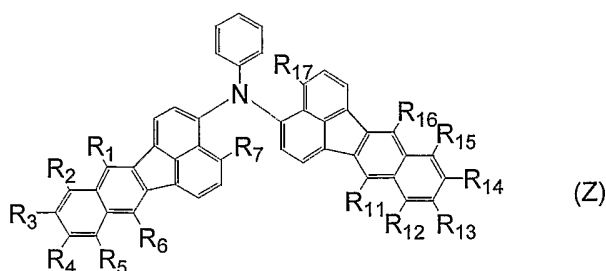

[式 (Z) 中、 $R_1 \sim R_7$ および $R_{11} \sim R_{17}$ Rは、水素、アルキル基、置換または非置換のアリール基、あるいは複素環基を表す。]

16. 下記式 (AAA') で表される基本骨格を有する請求の範囲第1項の有機EL素子用化合物。

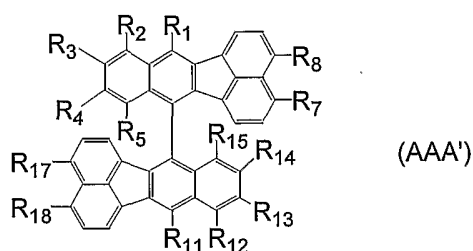

5

[式 (AAA') 中、 $R_1 \sim R_8$ 、および $R_{11} \sim R_{18}$ は、水素、アルキル基、置換基を有していてもよいアリール基、置換基を有していてもよいアリル基、置換基を有していてもよい複素環基、アミノ基、置換基を有していてもよいアリールアミノ基のいずれかを表す。]

10 17. 下記式 (BBB') で表される基本骨格を有する請求の範囲第1項の有機EL素子用化合物。

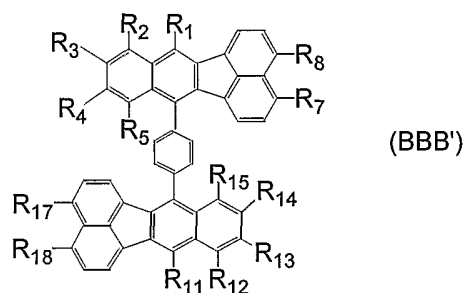

15 [式 (BBB') 中、 $R_1 \sim R_8$ 、および $R_{11} \sim R_{18}$ は、水素、アルキル基、置換基を有していてもよいアリール基、置換基を有していてもよいアリル基、置換基を有していてもよい複素環基、アミノ基、置換基を有していてもよいアリールアミノ基のいずれかを表す。]

18. 下記式 (CCC') で表される基本骨格を有する請求の範囲第1項の有機EL素子用化合物。

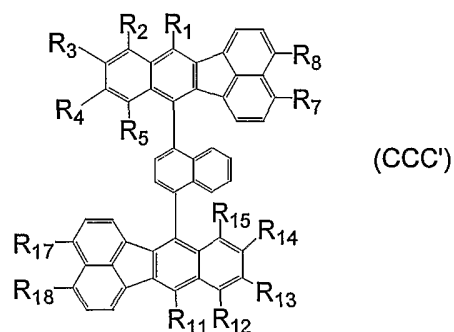

- [式 (CCC') 中、 $R_1 \sim R_8$ 、および $R_{11} \sim R_{18}$ は、水素、アルキル基、置換基を有していてもよいアリール基、置換基を有していてもよいアリル基、置換基を有していてもよい複素環基、アミノ基、置換基を有していてもよいアリールアミノ基のいずれかを表す。]

19. 下記式 (DDD') で表される基本骨格を有する請求の範囲第 1 項の有機 EL 素子用化合物。

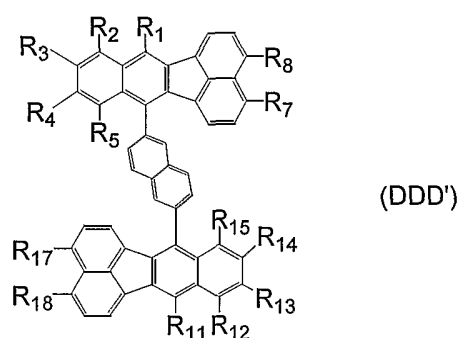

- [式 (DDD') 中、 $R_1 \sim R_8$ 、および $R_{11} \sim R_{18}$ は、水素、アルキル基、置換基を有していてもよいアリール基、置換基を有していてもよいアリル基、置換基を有していてもよい複素環基、アミノ基、置換基を有していてもよいアリールアミノ基のいずれかを表す。]

20. 下記式 (EEE') で表される基本骨格を有する請求の範囲第 1 項の有機 EL 素子用化合物。

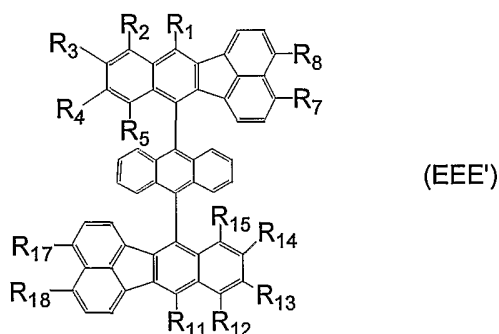

[式 (EEE') 中、 $R_1 \sim R_8$ 、および $R_{11} \sim R_{18}$ は、水素、アルキル基、置換基を有していてもよいアリール基、置換基を有していてもよいアリル基、置換基を有していてもよい複素環基、アミノ基、置換基を有していてもよいアリールアミノ基のいずれかを表す。]

21. 下記式 (RRR') で表される基本骨格を有する請求の範囲第 1 項の有機 EL 素子用化合物。

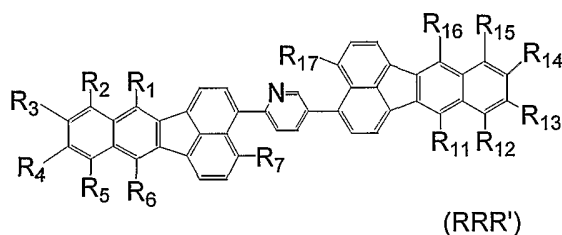

[式 (RRR') 中、 $R_1 \sim R_8$ 、および $R_{11} \sim R_{18}$ は、水素、アルキル基、置換基を有していてもよいアリール基、置換基を有していてもよいアリル基、置換基を有していてもよい複素環基、アミノ基、置換基を有していてもよいアリールアミノ基のいずれかを表す。]

22. 下記式 (SSS') で表される基本骨格を有する請求の範囲第 1 項の有機 EL 素子用化合物。

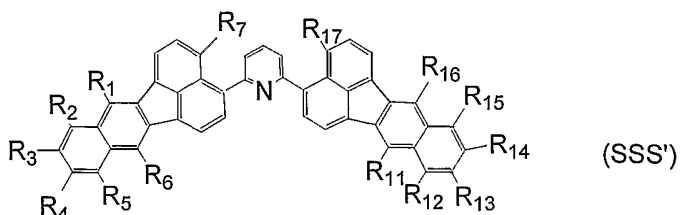

[式 (SSS') 中、 $R_1 \sim R_8$ 、および $R_{11} \sim R_{18}$ は、水素、アルキル基、置換基を有していてもよいアリール基、置換基を有していてもよいアリル基、置換基を有していてもよい複素環基、アミノ基、置換基を有していてもよいアリアルアミノ基のいずれかを表す。]

- 5 23. 一対の電極間に少なくとも発光機能に関与する1種または2種以上の有機層を有し、
- 前記有機層の少なくとも1層には請求の範囲第1項の有機EL素子用化合物を1種又は2種以上含有する有機EL素子。
24. 前記有機EL素子用化合物に加え、さらにアントラセン系化合物の
- 10 1種又は2種以上含有する請求の範囲第23項の有機EL素子。
25. 前記アントラセン誘導体を発光層のホスト材料として含有する請求の範囲第24項の有機EL素子。
26. 前記有機EL素子用化合物をドーパントとして含有する請求の範囲第23項の有機EL素子。
- 15 27. 前記有機EL用化合物を発光層に含有する請求の範囲第23項の有機EL素子。
28. 前記有機EL用化合物を電子輸送層に含有する請求の範囲第23項の有機EL素子。
29. 前記有機EL素子用化合物をホール注入輸送層に含有する請求の範囲
- 20 第23項の有機EL素子。
30. 2種以上の発光材料による2種以上の発光極大波長を有する請求の範囲第23項の有機EL素子。

1/8

FIG. 1

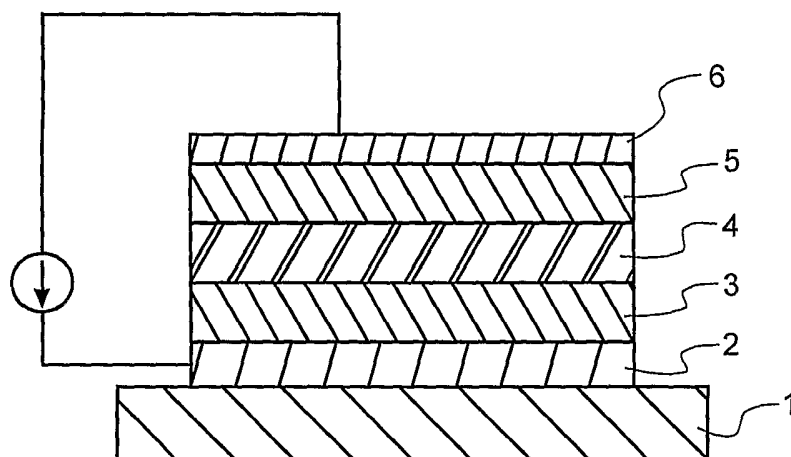
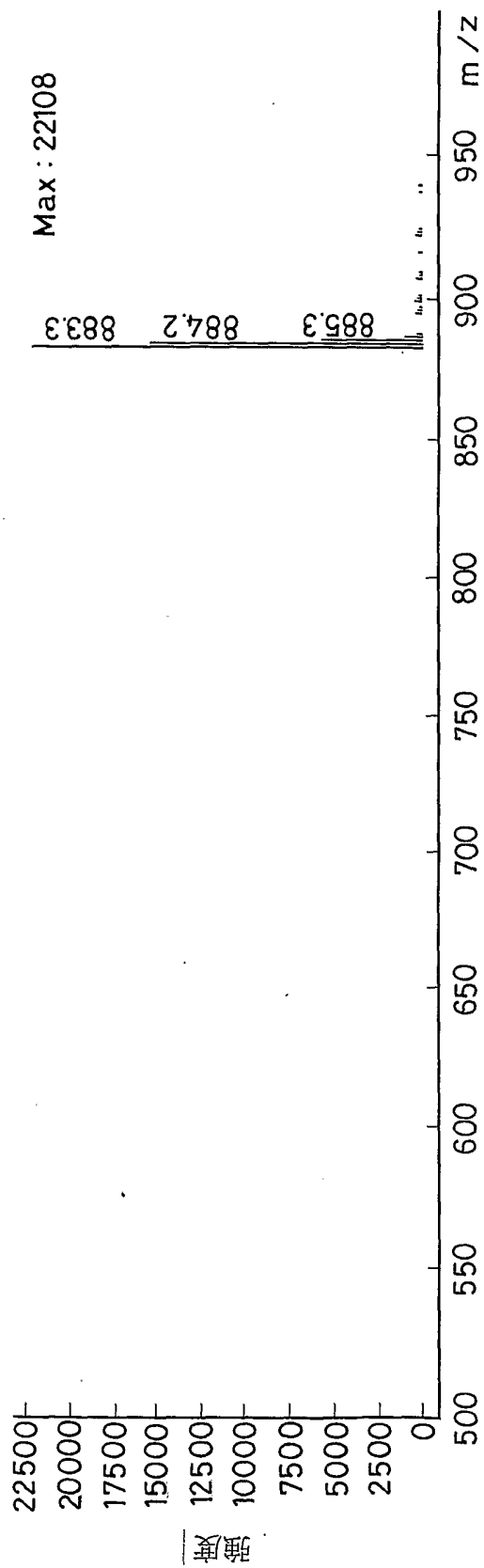

FIG. 2



差替え用紙 (規則26)

FIG. 3

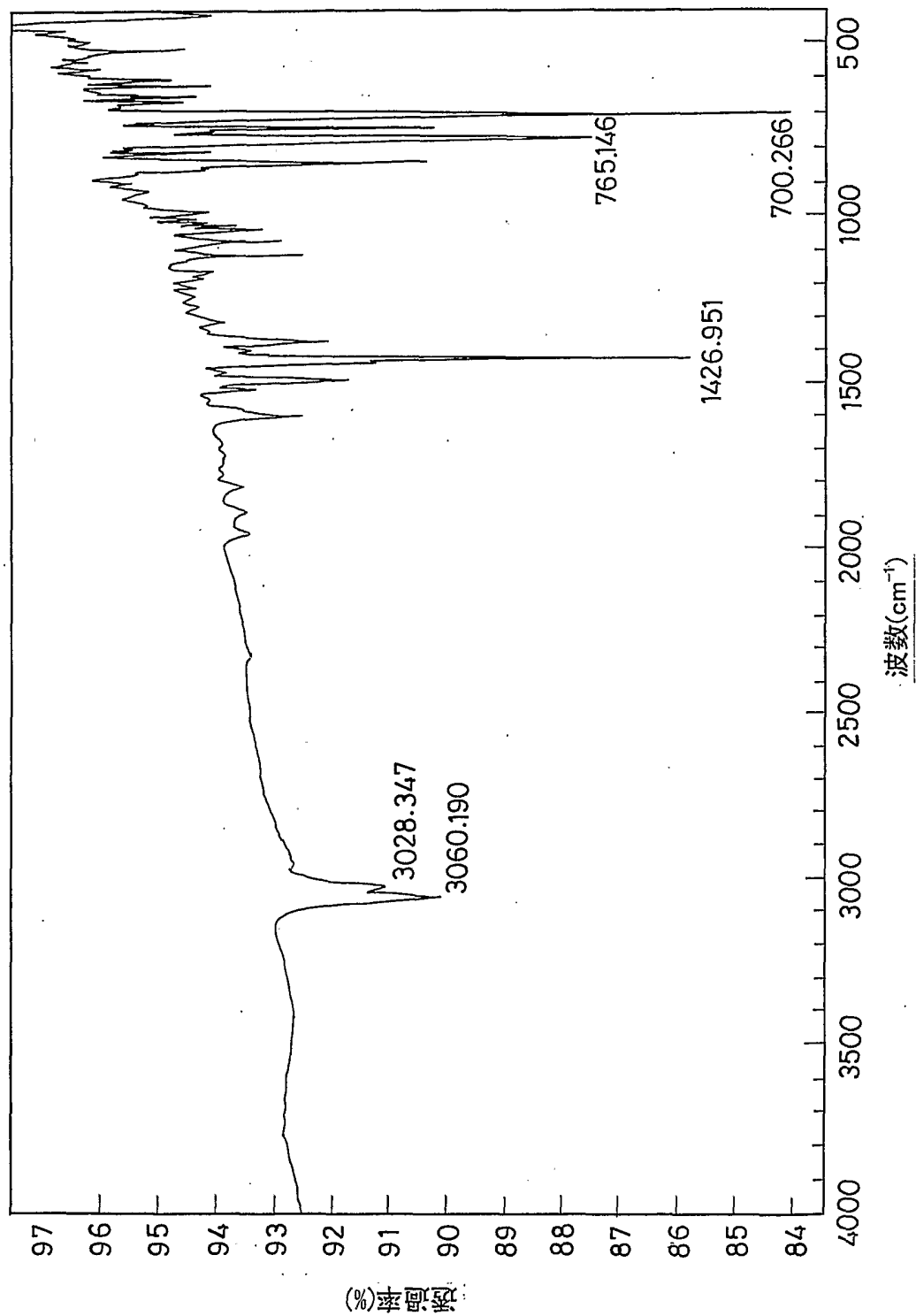

FIG. 4

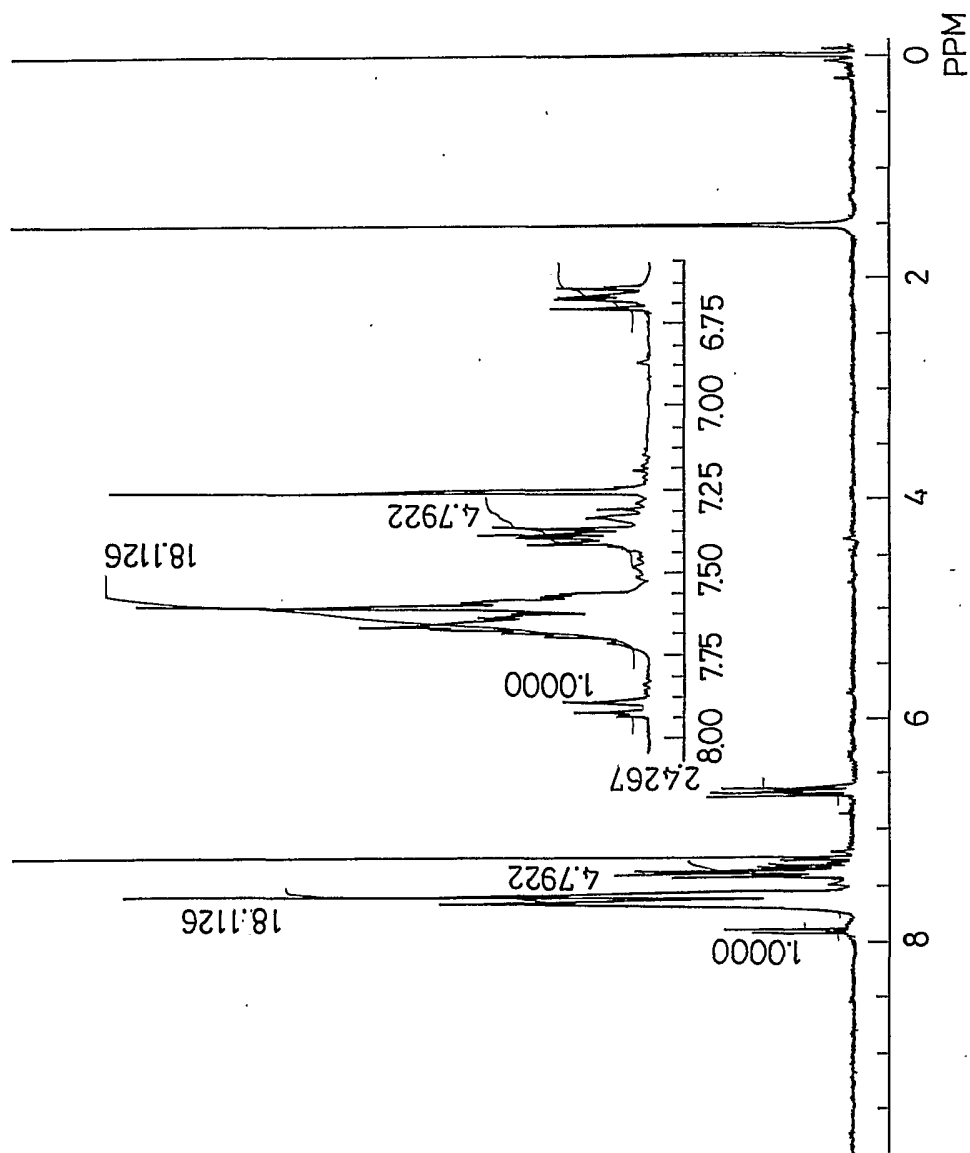

FIG. 5

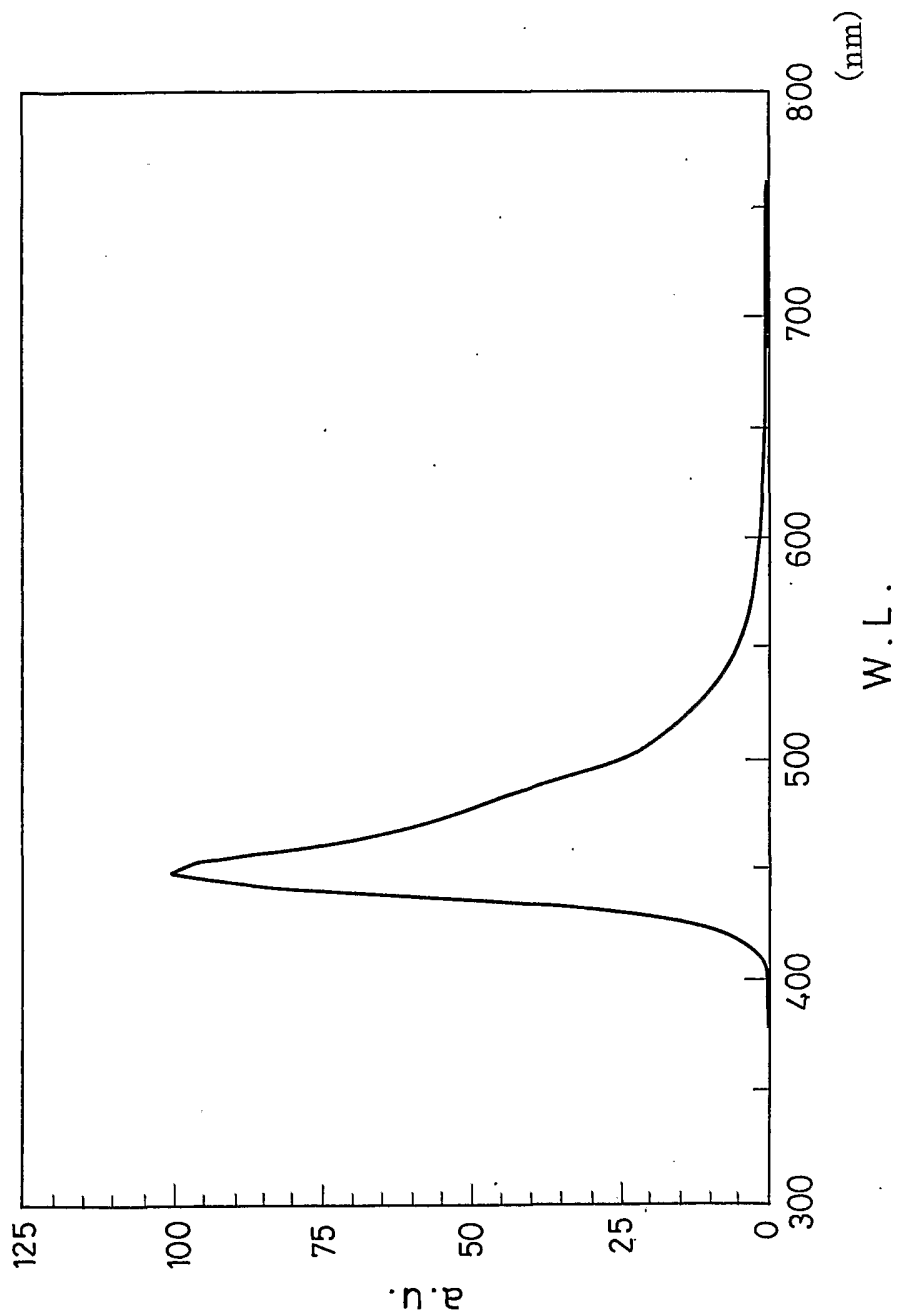

FIG. 6

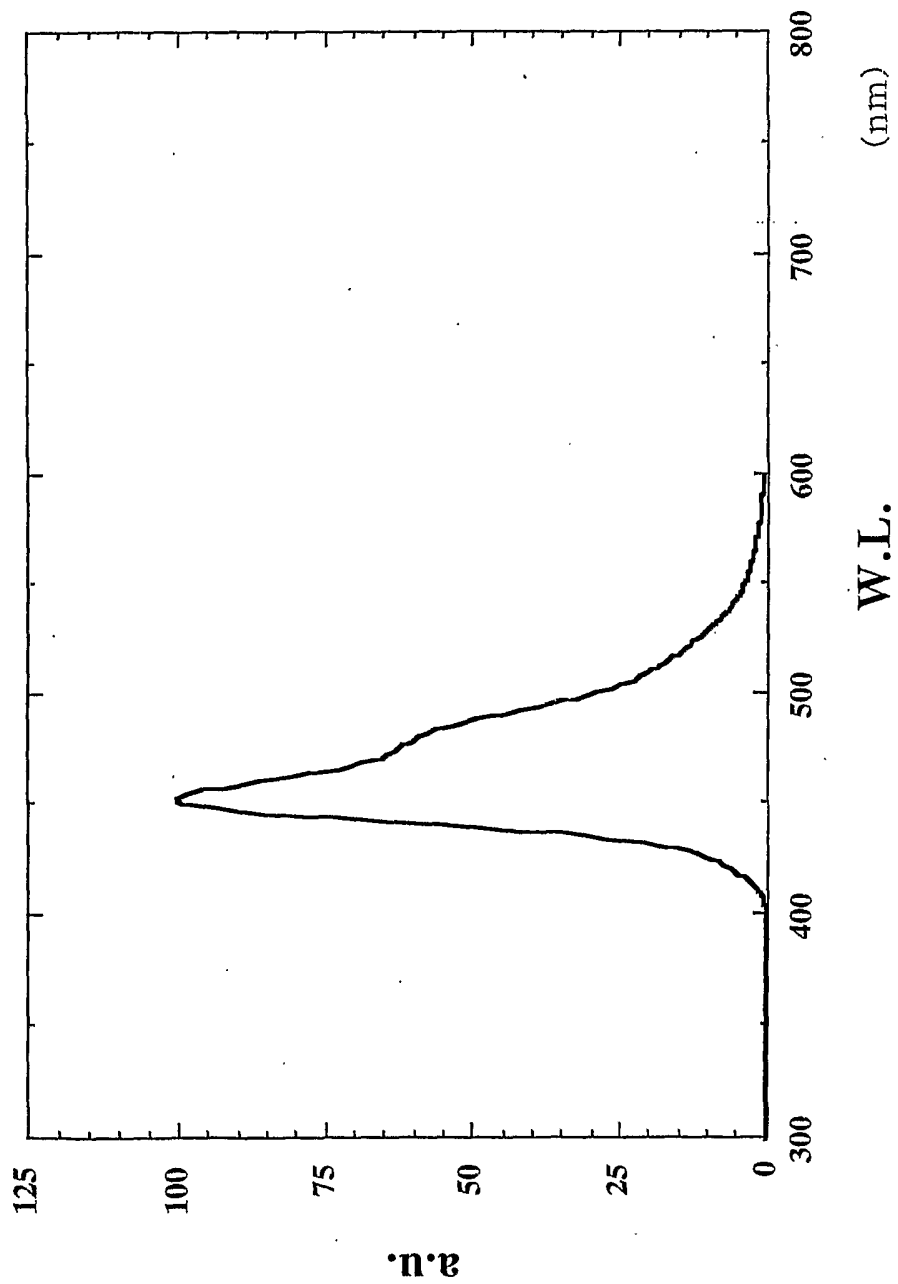

FIG. 7

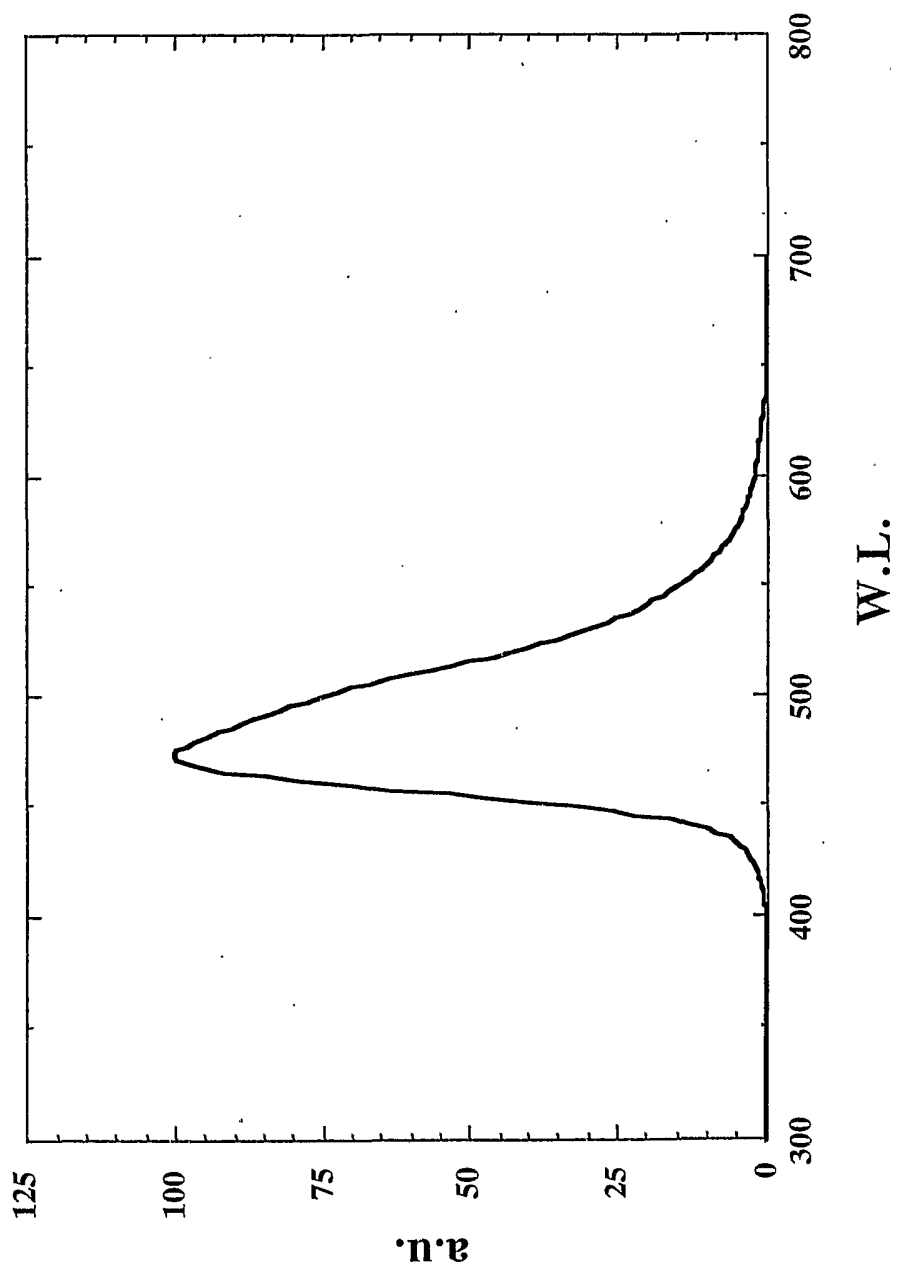
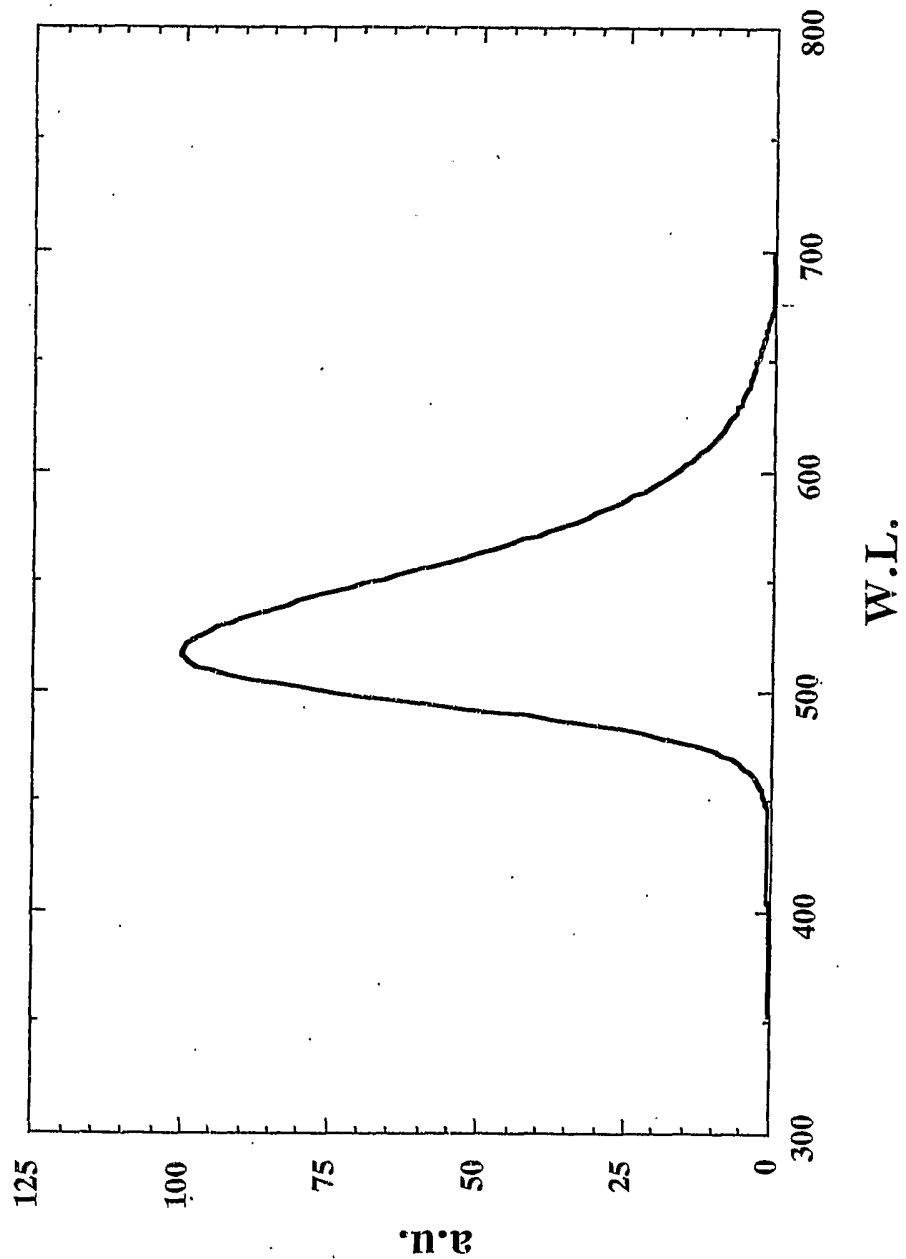

FIG. 8



INTERNATIONAL SEARCH REPORT

International application No.

PCT/JP02/03925

A. CLASSIFICATION OF SUBJECT MATTER Int.Cl ⁷ C07C13/62, 211/54, 211/61, C09K11/06, C07D213/06, 333/08, 333/76, H05B33/14, 33/22 According to International Patent Classification (IPC) or to both national classification and IPC		
B. FIELDS SEARCHED Minimum documentation searched (classification system followed by classification symbols) Int.Cl ⁷ C07C13/62, 211/54, 211/61, C09K11/06, C07D213/06, 333/08, 333/76, H05B33/14, 33/22 Documentation searched other than minimum documentation to the extent that such documents are included in the fields searched Electronic data base consulted during the international search (name of data base and, where practicable, search terms used) CAPLUS (STN), CAOLD (STN), REGISTRY (STN)		
C. DOCUMENTS CONSIDERED TO BE RELEVANT		
Category*	Citation of document, with indication, where appropriate, of the relevant passages	Relevant to claim No.
X	JP 11-12205 A (Mitsui Chemicals, Ltd.), 19 January, 1999 (19.01.99), A (Family: none)	1, 3-6, 23-30 2, 7-22
X	JP 2000-178212 A (Mitsui Chemicals, Ltd.), 27 June, 2000 (27.06.00), A (Family: none)	1, 3-6, 23-30 2, 7-22
X	JP 2000-186054 A (Mitsui Chemicals, Ltd.), 04 July, 2000 (04.07.00), A (Family: none)	1, 3-6, 23-30 2, 7-22
<input checked="" type="checkbox"/> Further documents are listed in the continuation of Box C. <input type="checkbox"/> See patent family annex.		
* Special categories of cited documents: "A" document defining the general state of the art which is not considered to be of particular relevance "E" earlier document but published on or after the international filing date "L" document which may throw doubts on priority claim(s) or which is cited to establish the publication date of another citation or other special reason (as specified) "O" document referring to an oral disclosure, use, exhibition or other means "P" document published prior to the international filing date but later than the priority date claimed		"I" later document published after the international filing date or priority date and not in conflict with the application but cited to understand the principle or theory underlying the invention "X" document of particular relevance; the claimed invention cannot be considered novel or cannot be considered to involve an inventive step when the document is taken alone "Y" document of particular relevance; the claimed invention cannot be considered to involve an inventive step when the document is combined with one or more other such documents, such combination being obvious to a person skilled in the art "&" document member of the same patent family
Date of the actual completion of the international search 07 June, 2002 (07.06.02)		Date of mailing of the international search report 25 June, 2002 (25.06.02)
Name and mailing address of the ISA/ Japanese Patent Office		Authorized officer
Facsimile No.		Telephone No.

INTERNATIONAL SEARCH REPORT

International application No.

PCT/JP02/03925

C (Continuation). DOCUMENTS CONSIDERED TO BE RELEVANT

Category*	Citation of document, with indication, where appropriate, of the relevant passages	Relevant to claim No.
X	DEBAD, J.D. et al., Anodic Coupling of Diphenylbenzo [k] fluoranthene: Mechanistic and Kinetic Studies Utilizing Cyclic Voltammetry and Electrogenerated Chemiluminescence., J. Org. Chem., Vol.62, No.3 (1997), pages 530 to 537, particularly, page 532; Scheme 2; compound 2	1, 3
X	MALLAKPOUR, S.E. et al., A convenient one-step synthesis of dialkylbenzo[k]fluoranthenes and tetraethylbibenzo[k][k']fluoranthenes., Org.Prep. Proced. Int., Vol.28, No.6 (1996), pages 691 to 693, particularly, page 692; compound 4	1, 3
X	TAYLOR, R. et al., Formation of C60 by pyrolysis of naphthalene., Nature, Vol.366, No.6457 (1993), pages 728 to 731, particularly, page 730; Fig. 3	1, 3
P,X P,A	JP 2001-250688 A (Mitsui Chemicals, Ltd.), 14 September, 2001 (14.09.01), (Family: none)	1, 3-6, 23-30 2, 7-22
P,X P,A	JP 2001-257075 A (Mitsui Chemicals, Ltd.), 21 September, 2001 (21.09.01), (Family: none)	1, 3-6, 23-30 2, 7-22

A. 発明の属する分野の分類 (国際特許分類 (IPC))

Int. C1⁷ C07C13/62, 211/54, 211/61, C09K11/06,
C07D213/06, 333/08, 333/76, H05B33/14, 33/22

B. 調査を行った分野

調査を行った最小限資料 (国際特許分類 (IPC))

Int. C1⁷ C07C13/62, 211/54, 211/61, C09K11/06,
C07D213/06, 333/08, 333/76, H05B33/14, 33/22

最小限資料以外の資料で調査を行った分野に含まれるもの

国際調査で使用了電子データベース (データベースの名称、調査に使用した用語)

CAPLUS (STN)、CAOLD (STN)、REGISTRY (STN)

C. 関連すると認められる文献

引用文献の カテゴリー*	引用文献名 及び一部の箇所が関連するときは、その関連する箇所の表示	関連する 請求の範囲の番号
X A	JP 11-12205 A (三井化学株式会社) 1999. 01. 19 (ファミリーなし)	1, 3-6, 23-30 2, 7-22
X A	JP 2000-178212 A (三井化学株式会社) 2000. 06. 27 (ファミリーなし)	1, 3-6, 23-30 2, 7-22
X A	JP 2000-186054 A (三井化学株式会社) 2000. 07. 04 (ファミリーなし)	1, 3-6, 23-30 2, 7-22

C欄の続きにも文献が列挙されている。

パテントファミリーに関する別紙を参照。

* 引用文献のカテゴリー

「A」 特に関連のある文献ではなく、一般的技術水準を示すもの
「E」 国際出願日前の出願または特許であるが、国際出願日以後に公表されたもの
「L」 優先権主張に疑義を提起する文献又は他の文献の発行日若しくは他の特別な理由を確立するために引用する文献 (理由を付す)
「O」 口頭による開示、使用、展示等に言及する文献
「P」 国際出願日前で、かつ優先権の主張の基礎となる出願

の日の後に公表された文献

「T」 国際出願日又は優先日後に公表された文献であって出願と矛盾するものではなく、発明の原理又は理論の理解のために引用するもの
「X」 特に関連のある文献であって、当該文献のみで発明の新規性又は進歩性がないと考えられるもの
「Y」 特に関連のある文献であって、当該文献と他の1以上の文献との、当業者にとって自明である組合せによって進歩性がないと考えられるもの
「&」 同一パテントファミリー文献

国際調査を完了した日

07. 06. 02

国際調査報告の発送日

25.06.02

国際調査機関の名称及びあて先

日本国特許庁 (ISA/JJP)
郵便番号 100-8915
東京都千代田区霞が関三丁目4番3号

特許庁審査官 (権限のある職員)

藤森 知郎



4H 9357

電話番号 03-3581-1101 内線 3443

C (続き) 関連すると認められる文献		
引用文献の カテゴリー*	引用文献名 及び一部の箇所が関連するときは、その関連する箇所の表示	関連する 請求の範囲の番号
X	DEBAD, J. D. et al., Anodic Coupling of Diphenylbenzo[k]fluoranthene: Mechanistic and Kinetic Studies Utilizing Cyclic Voltammetry and Electrogenerated Chemiluminescence., J. Org. Chem., Vol.62, No.3 (1997) p.530-p.537 特に、第532頁Scheme 2 化合物2 参照	1,3
X	MALLAKPOUR, S. E. et al., A convenient one-step synthesis of dialkylbenzo[k]fluoranthenes and tetraethylbibenzo[k][k']fluoranthenes., Org. Prep. Proced. Int., Vol.28, No.6 (1996) p.691-p.693 特に、第692頁化合物4 参照	1,3
X	TAYLOR, R. et al., Formation of C60 by pyrolysis of naphthalene., Nature, Vol.366, No.6457 (1993) p.728-p.731 特に、第730頁FIG. 3	1,3
PX PA	JP 2001-250688 A (三井化学株式会社) 2001.09.14 (ファミリーなし)	1,3-6,23-30 2,7-22
PX PA	JP 2001-257075 A (三井化学株式会社) 2001.09.21 (ファミリーなし)	1,3-6,23-30 2,7-22