



(19) **United States**

(12) **Patent Application Publication**
LEE et al.

(10) **Pub. No.: US 2023/0275724 A1**

(43) **Pub. Date: Aug. 31, 2023**

(54) **PILOT TRANSMISSION AND RECEPTION FOR ORTHOGONAL FREQUENCY DIVISION MULTIPLE ACCESS**

(71) Applicant: **Atlas Global Technologies LLC**,
Austin, TX (US)

(72) Inventors: **Dae Won LEE**, Austin, TX (US);
Young Hoon KWON, Austin, TX (US);
Sungho MOON, Austin, TX (US);
Yujin NOH, Austin, TX (US)

(21) Appl. No.: **18/313,167**

(22) Filed: **May 5, 2023**

Publication Classification

(51) **Int. Cl.**
H04L 5/00 (2006.01)
H04W 72/1263 (2006.01)
H04L 27/00 (2006.01)
H04L 27/26 (2006.01)
H04W 72/20 (2006.01)
(52) **U.S. Cl.**
CPC *H04L 5/0048* (2013.01); *H04L 5/0007*
(2013.01); *H04W 72/1263* (2013.01); *H04L 27/0014* (2013.01); *H04L 27/2657* (2013.01);
H04W 72/20 (2023.01); *H04L 5/001*
(2013.01); *H04W 84/12* (2013.01)

Related U.S. Application Data

(63) Continuation of application No. 17/882,403, filed on Aug. 5, 2022, now Pat. No. 11,652,594, which is a continuation of application No. 17/334,290, filed on May 28, 2021, now Pat. No. 11,418,307, which is a continuation of application No. 16/816,092, filed on Mar. 11, 2020, now Pat. No. 11,050,539, which is a continuation of application No. 16/443,683, filed on Jun. 17, 2019, now Pat. No. 10,630,444, which is a continuation of application No. 15/444,188, filed on Feb. 27, 2017, now Pat. No. 10,361,828, which is a continuation of application No. 15/150,127, filed on May 9, 2016, now Pat. No. 9,621,311.

(60) Provisional application No. 62/159,187, filed on May 8, 2015.

(57) **ABSTRACT**

A wireless device transmits a frame by determining a plurality of Resource Units (RUs) of the frame, providing pilots in a first RU of the frame at a first set of positions, providing pilots in a second RU of the frame at a second set of positions, and transmitting the frame. The first set of positions is different from the second set of positions. A wireless device receives a frame including an RU including pilots and processes the pilots. When an RU for the data symbol includes an odd-numbered lowest subcarrier, the pilots are included at a first set of positions in the resource unit. When the RU includes an even-numbered lowest subcarrier, the pilots are included at a second set of positions in the resource unit. The second set of positions is different from the first set of positions.

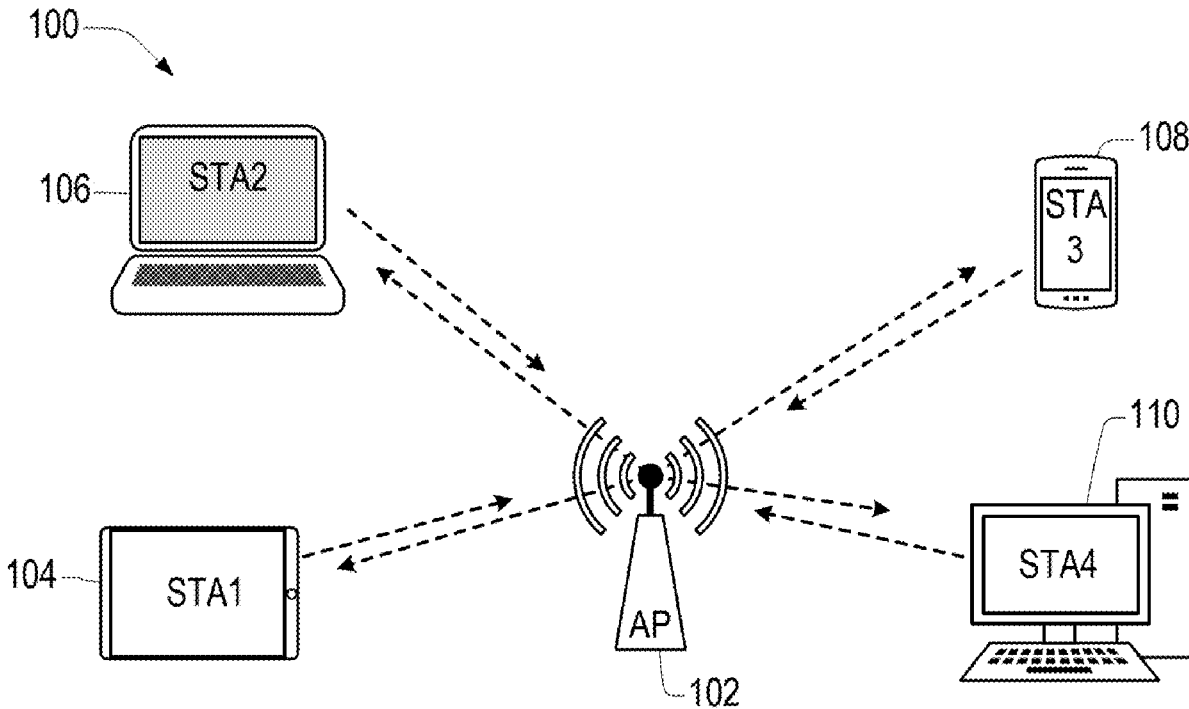

FIG. 1

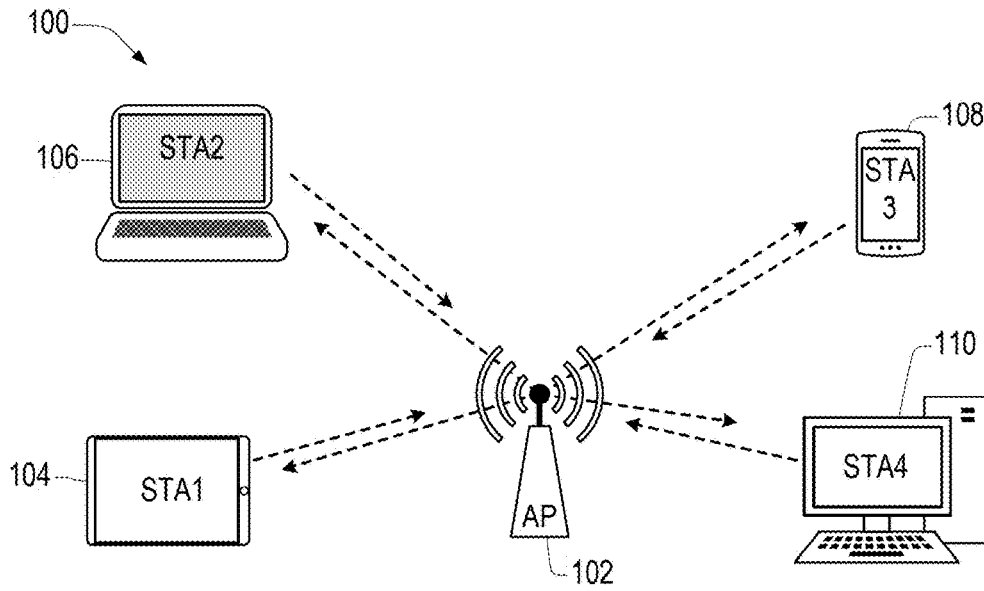

FIG. 2

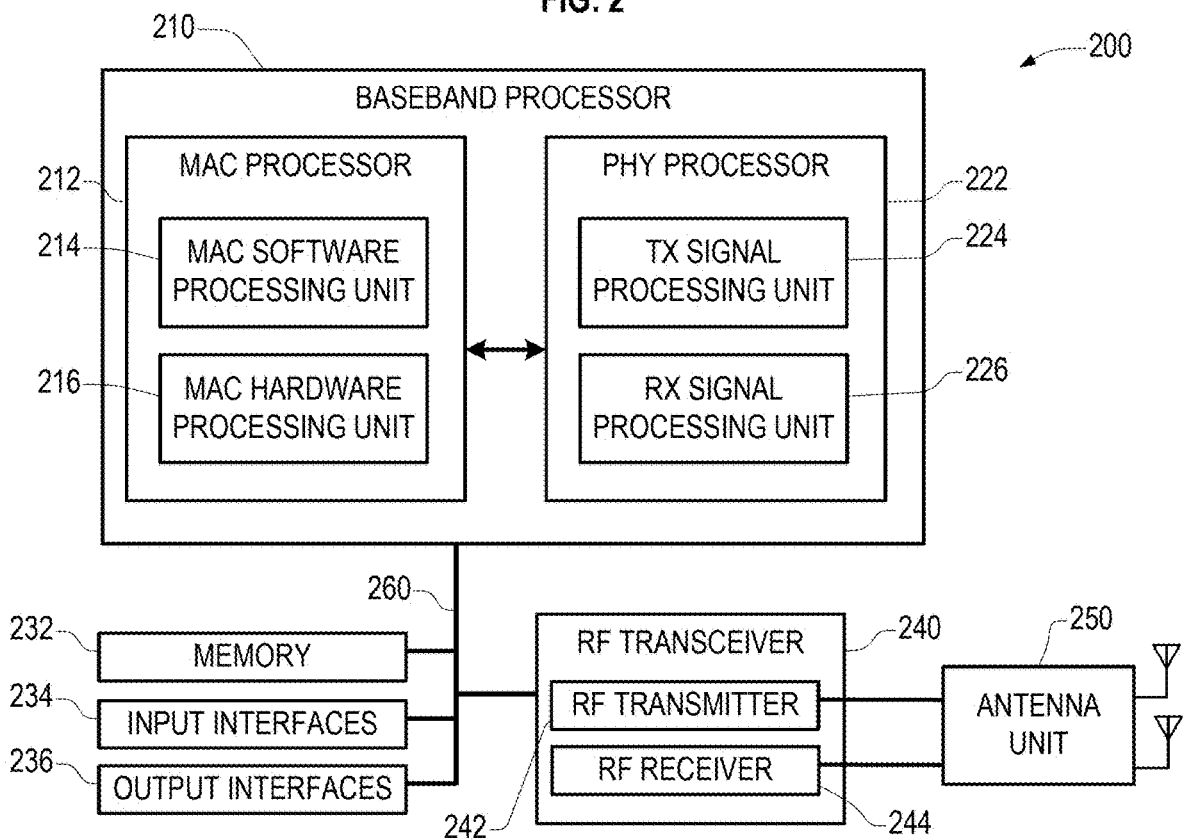

FIG. 3A

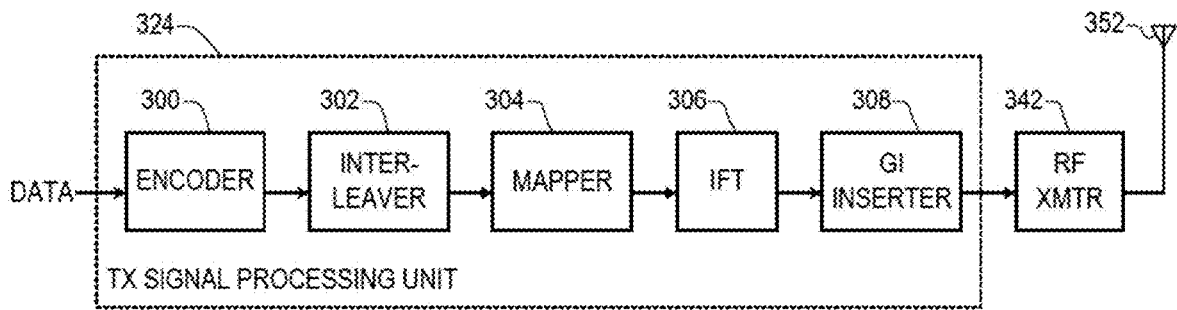

FIG. 3B

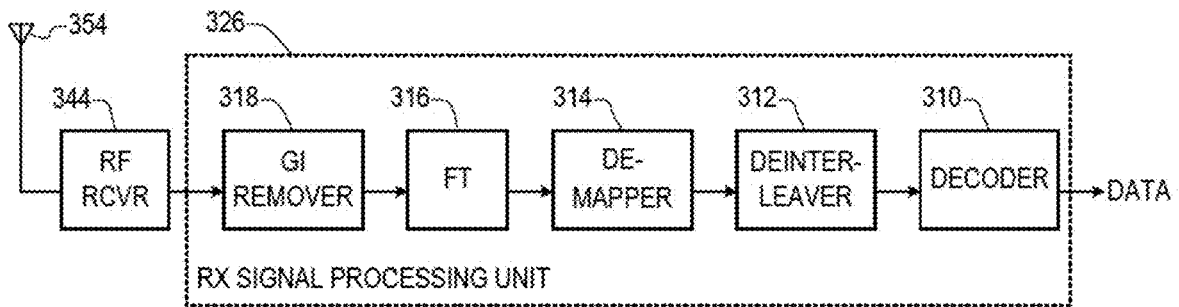

FIG. 4A

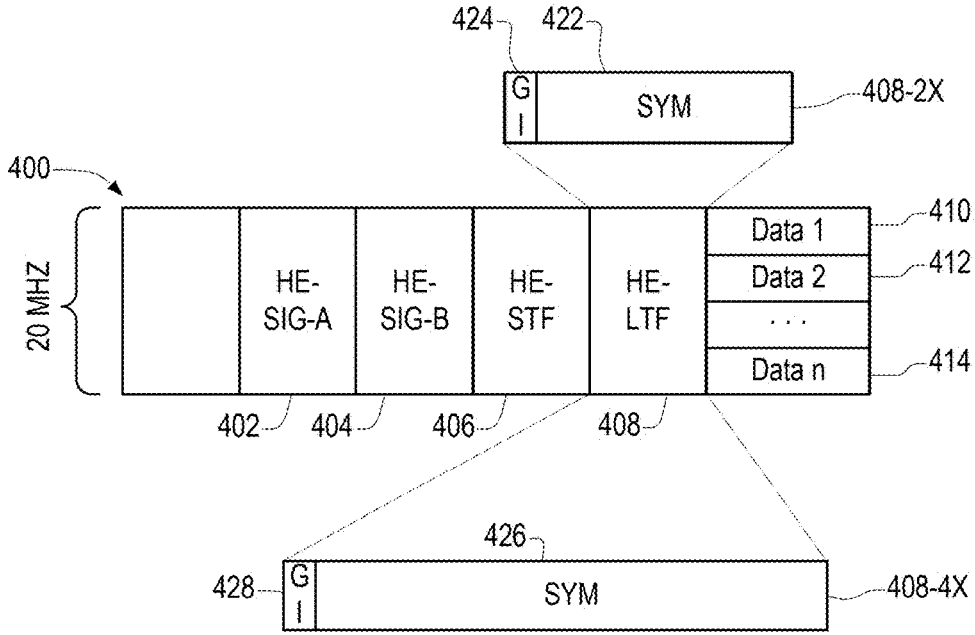

FIG. 4B

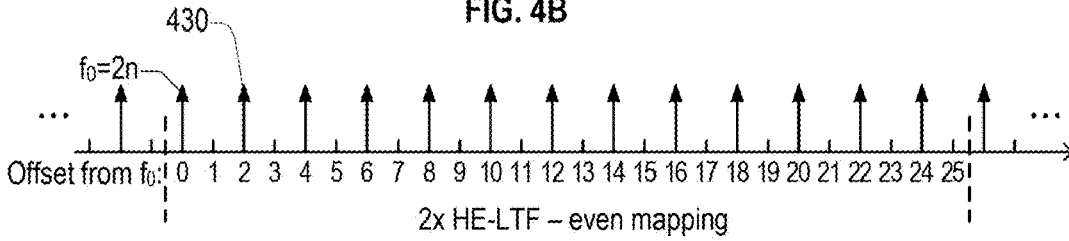

FIG. 4C

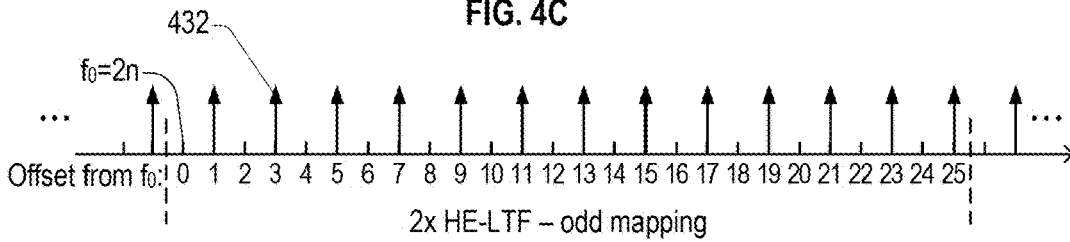
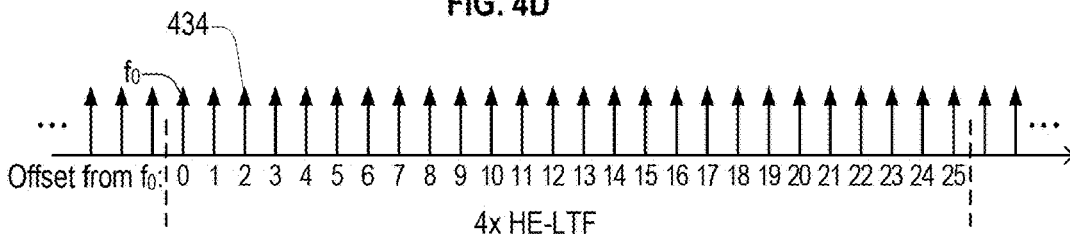

FIG. 4D



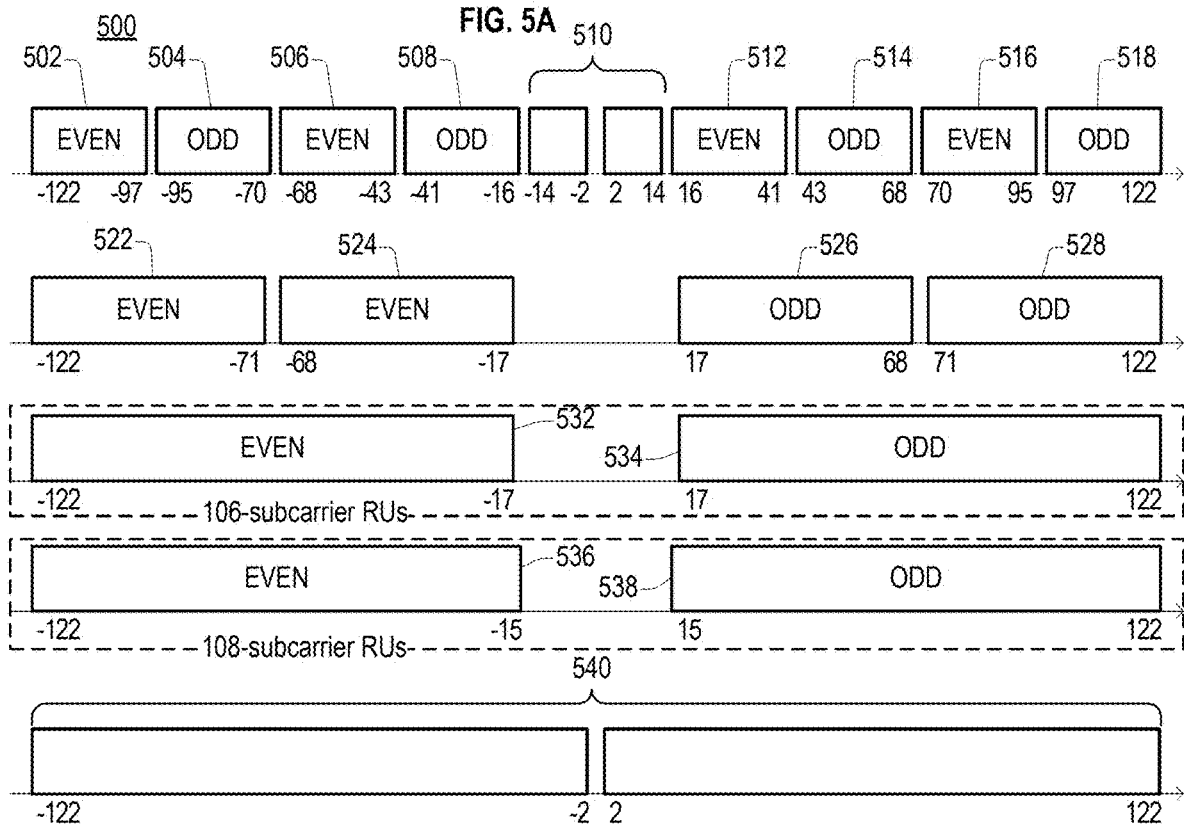

FIG. 5B Table 1

Ref.	No. of SCs	Low SC Index	High SC Index	Type
502	26	-122	-97	EVEN
504	26	-95	-70	ODD
506	26	-68	-43	EVEN
508	26	-41	-16	ODD
510	26	-14	-2	CENTER
		2	14	
512	26	16	41	EVEN
514	26	43	68	ODD
516	26	70	95	EVEN
518	26	97	122	ODD
522	52	-122	-71	EVEN
524	52	-68	-17	EVEN
526	52	17	69	ODD
528	52	71	122	ODD
532	106	-122	-17	EVEN
534	106	17	122	ODD
536	108	-122	-15	EVEN
538	108	15	122	ODD
540	242	-122	-2	EVEN
		2	122	

FIG. 6

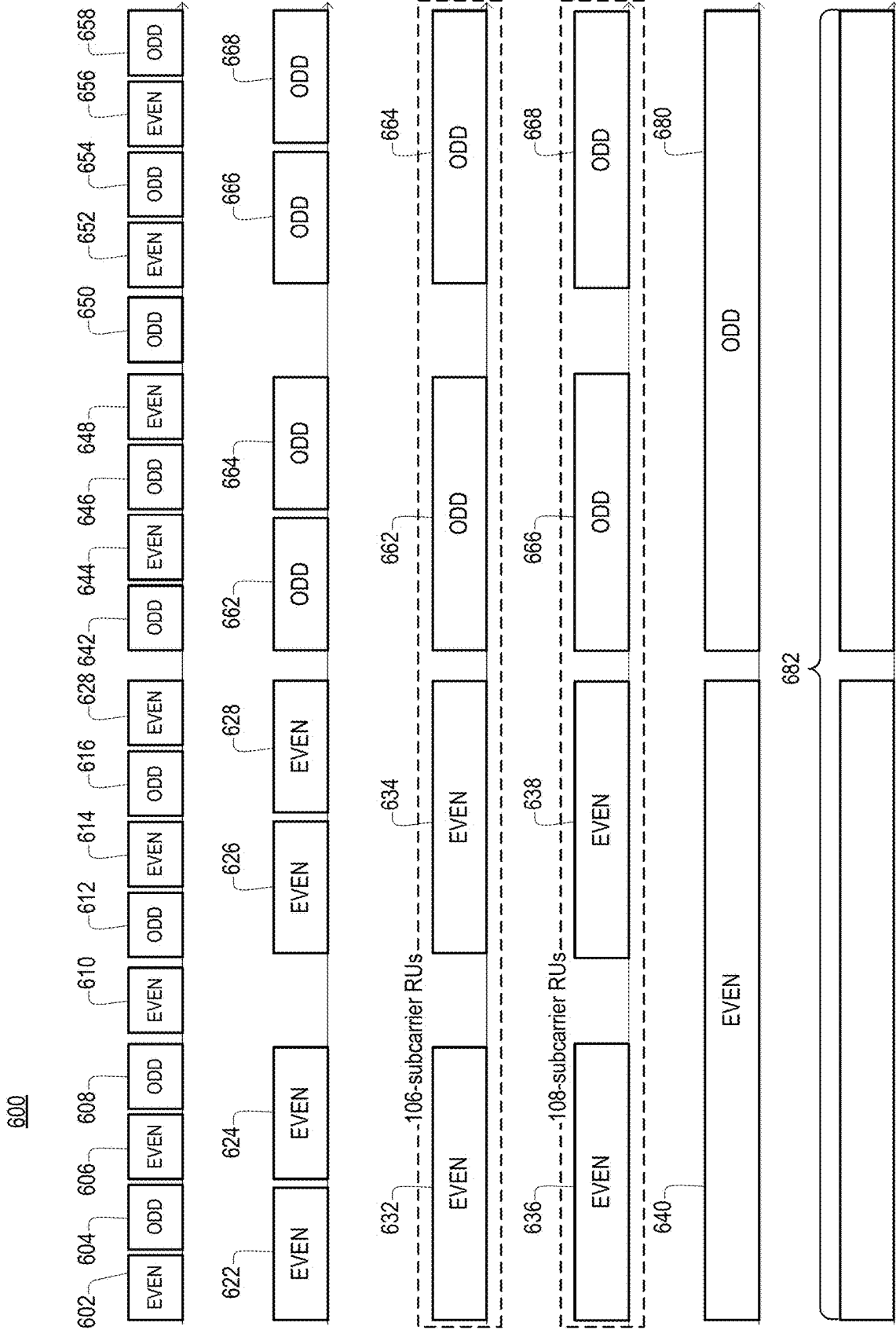
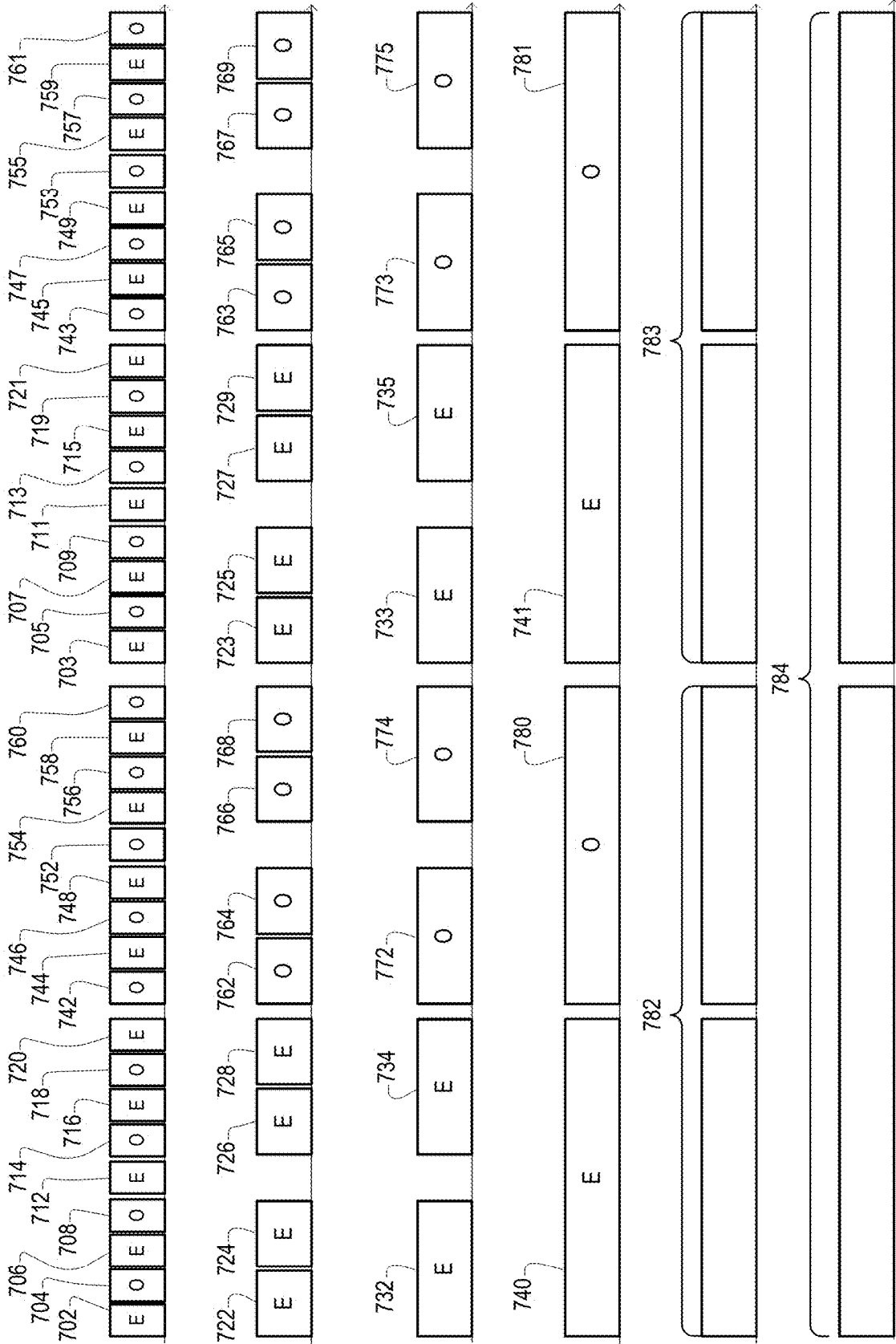

FIG. 7

700



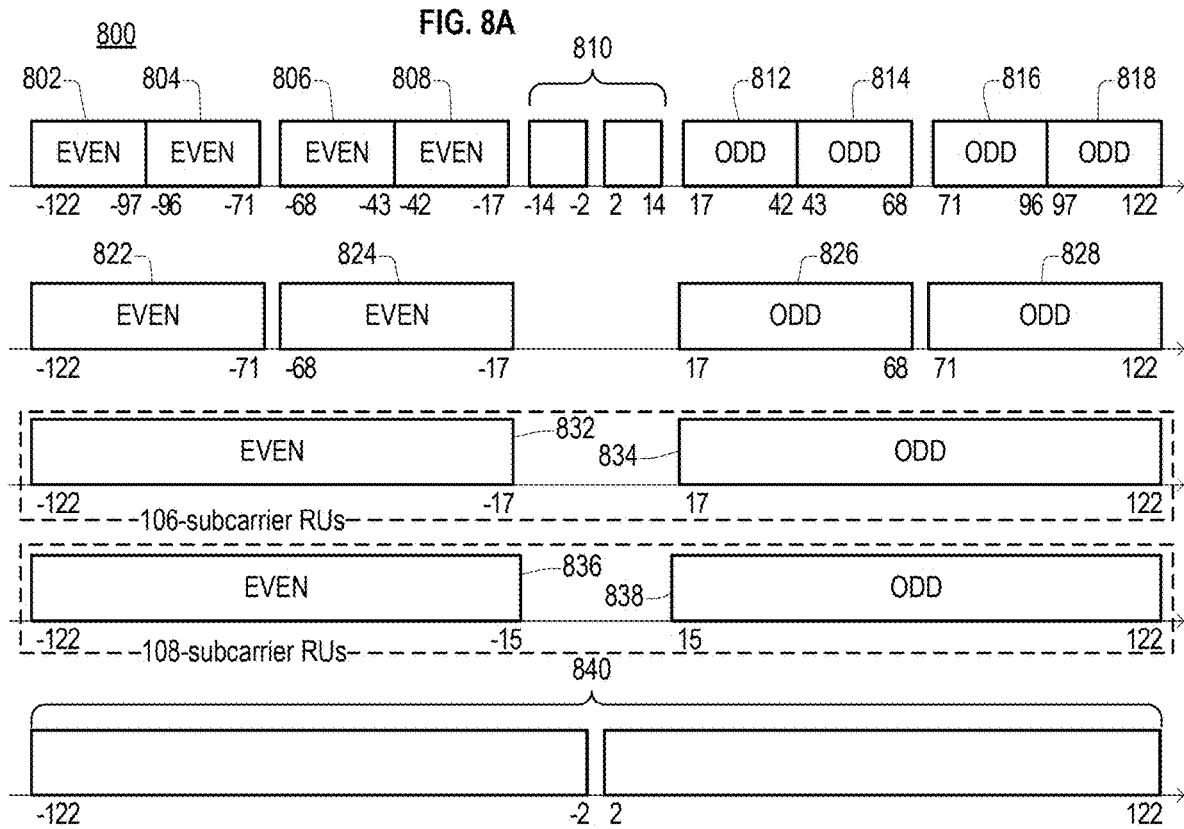
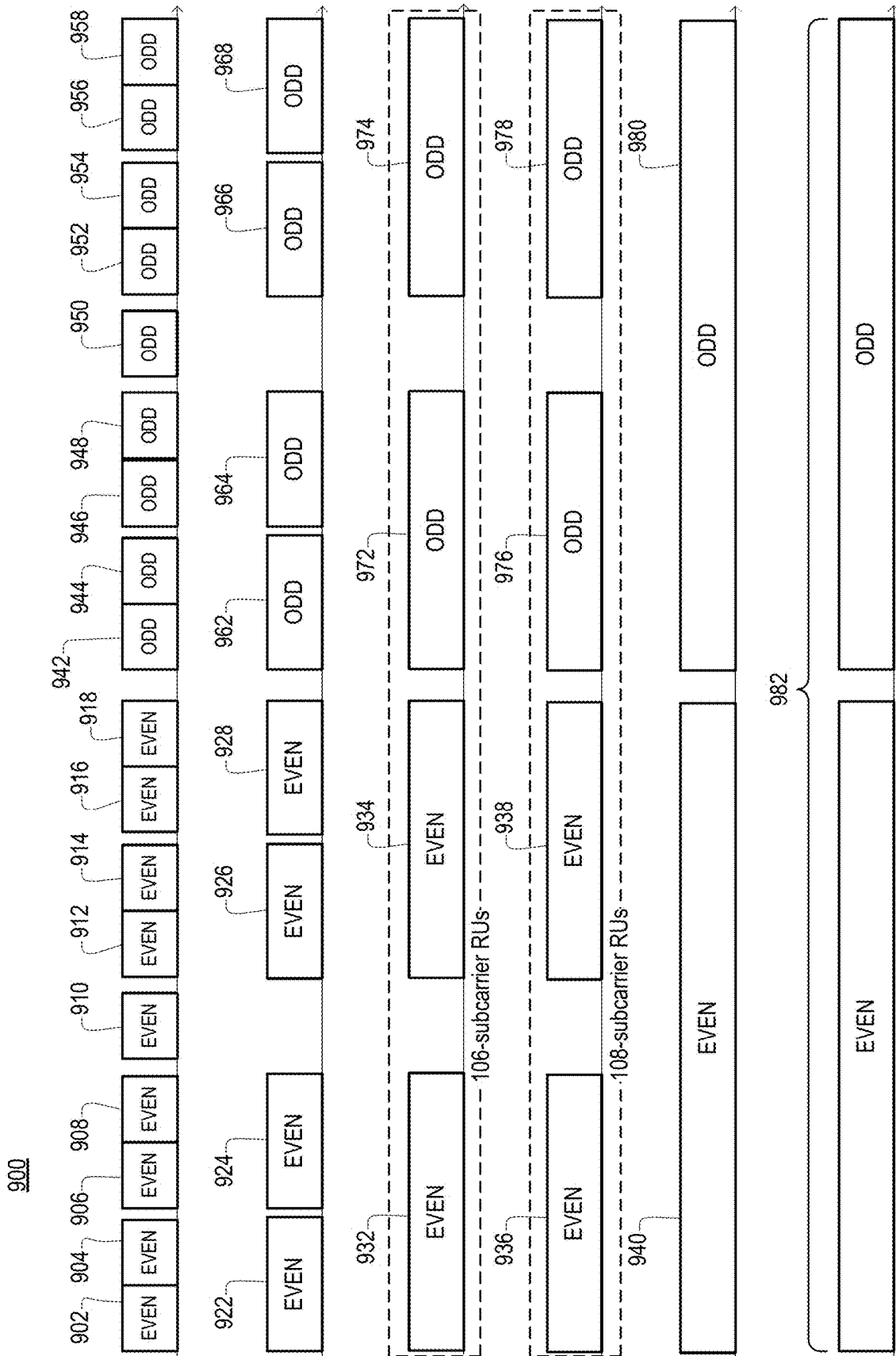

FIG. 8B Table 2

Ref.	No. of SCs	First SC Index	Last SC Index	Type
802	26	-122	-97	EVEN
804	26	-96	-71	EVEN
806	26	-68	-43	EVEN
808	26	-42	-17	EVEN
810	26	-14	-2	CENTER
		2	14	
812	26	17	42	ODD
814	26	43	68	ODD
816	26	71	96	ODD
818	26	97	122	ODD
822	52	-122	-71	EVEN
824	52	-68	-17	EVEN
826	52	17	69	ODD
828	52	71	122	ODD
832	106	-122	-17	EVEN
834	106	17	122	ODD
836	108	-122	-15	EVEN
838	108	15	122	ODD
840	242	-122	-2	EVEN
		2	122	

FIG. 9



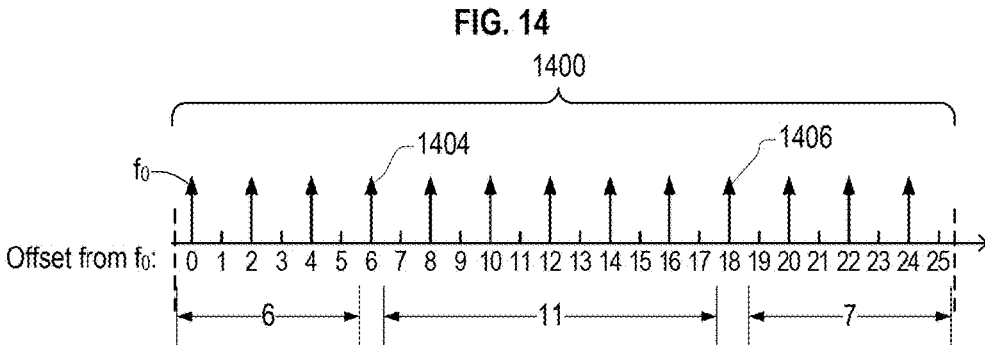
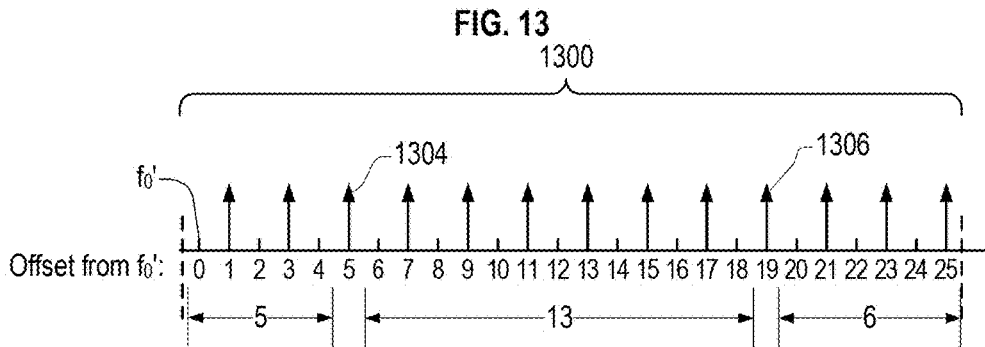
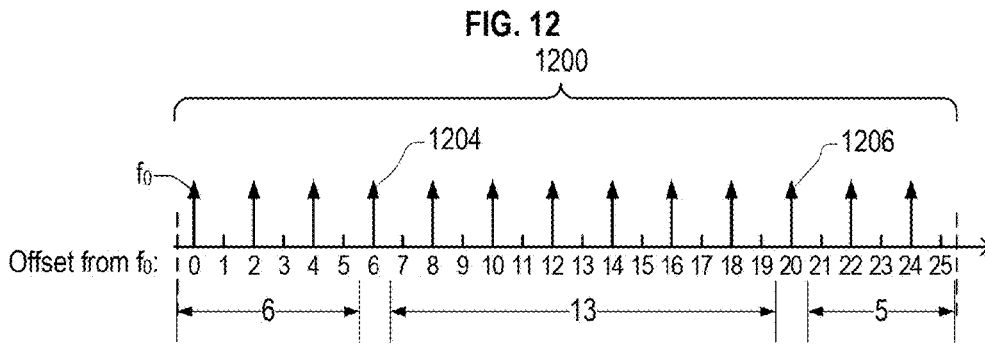
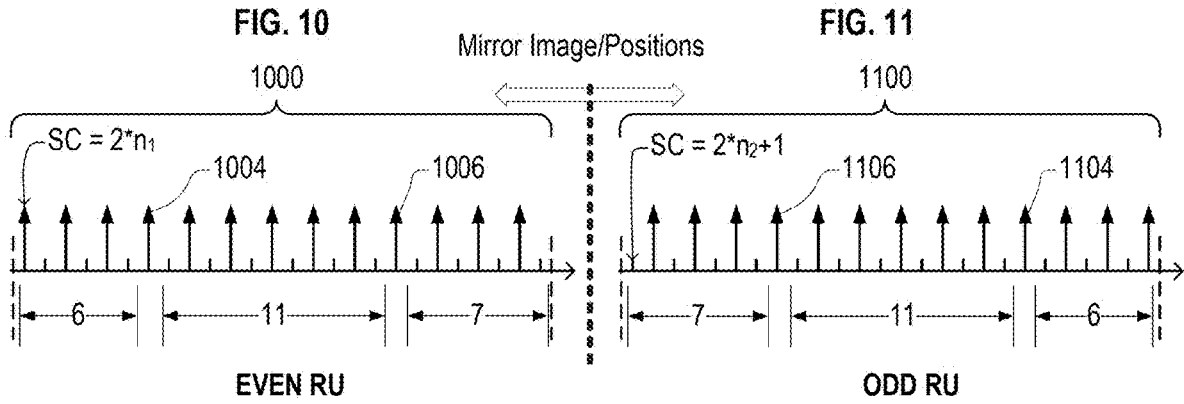

FIG. 15

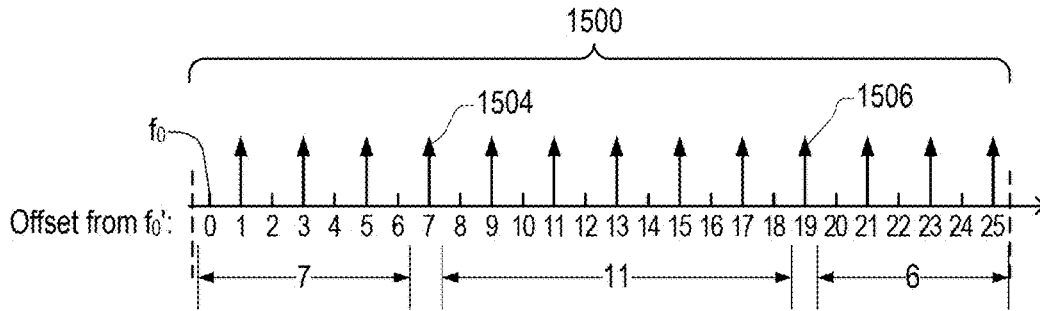

FIG. 16

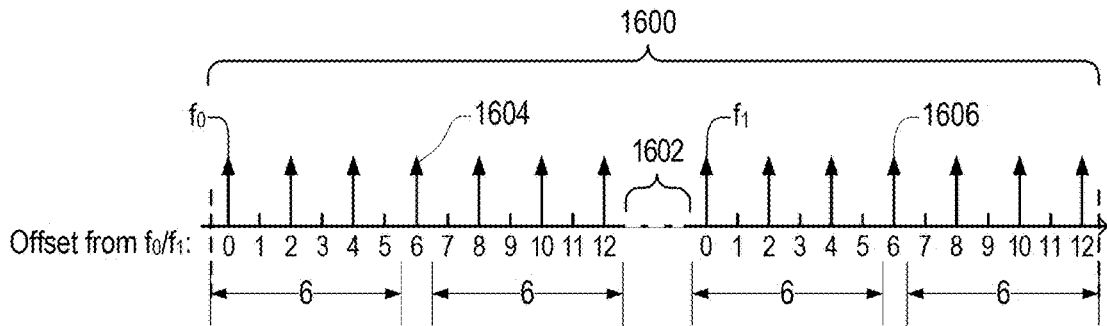

FIG. 17

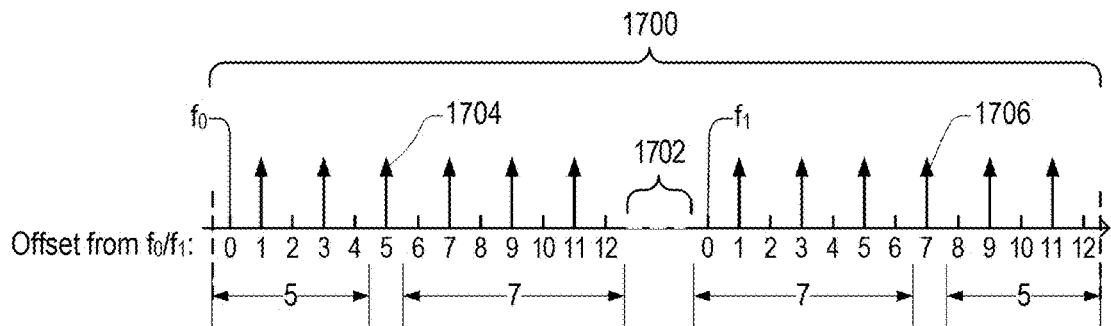

FIG. 18

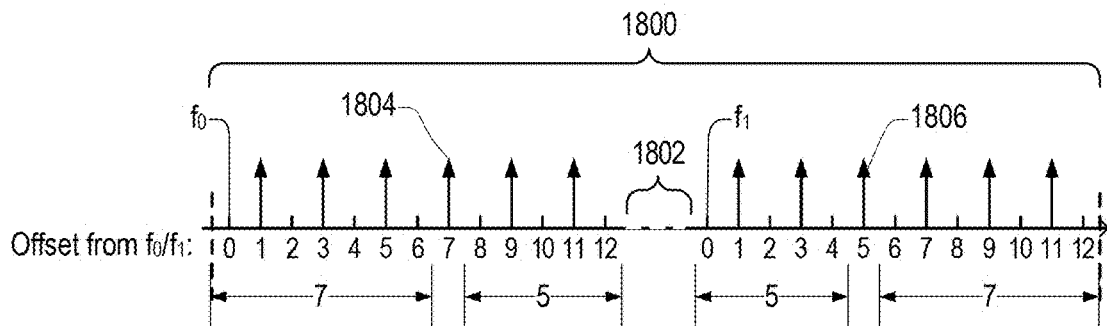

FIG. 19

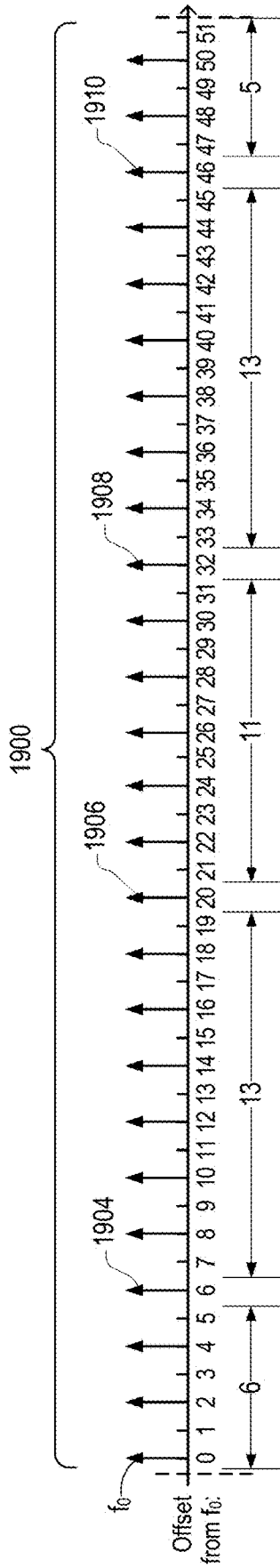

FIG. 20

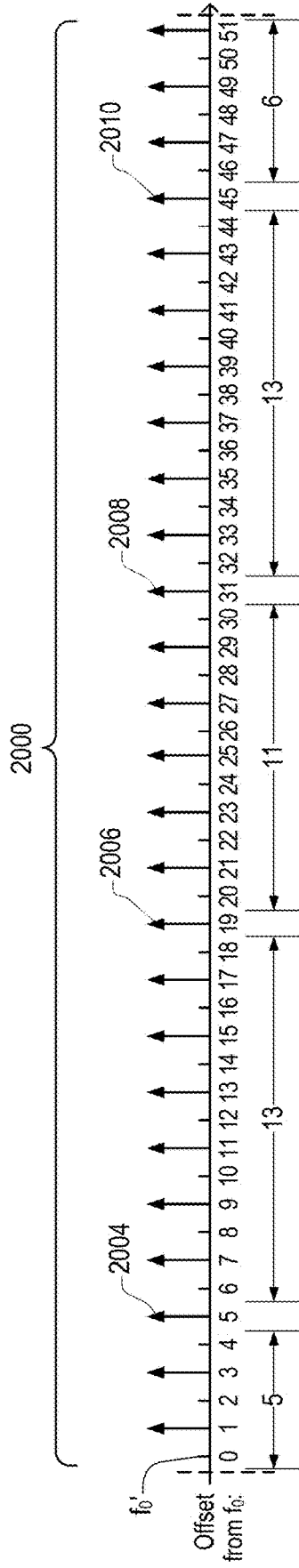

FIG. 21

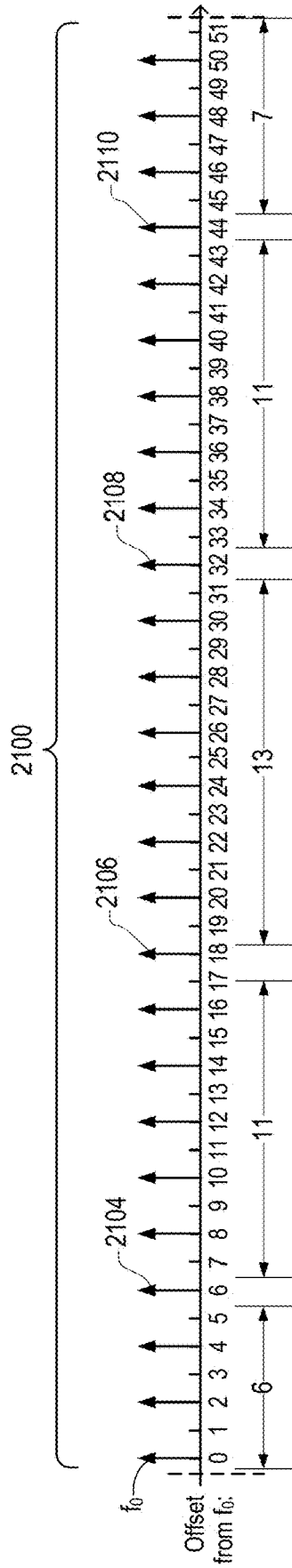

FIG. 22

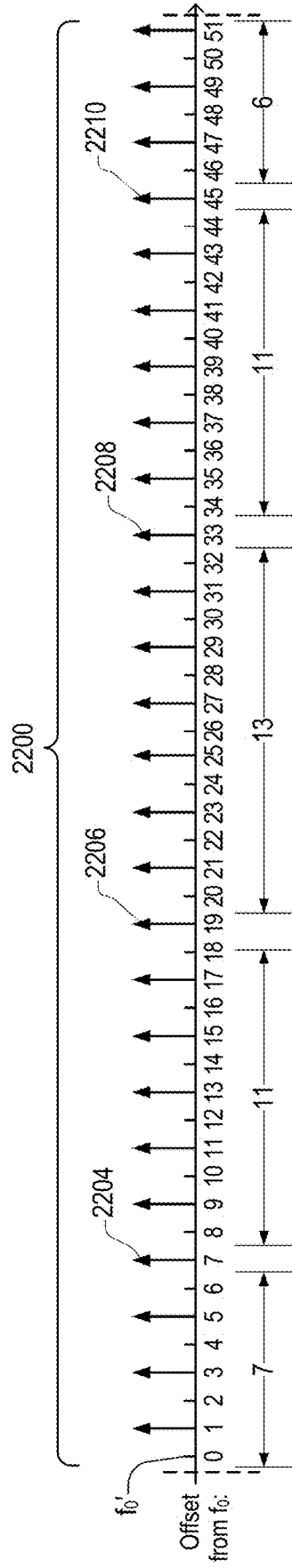

FIG. 23

Table 3. Pilot Tone Relative Positions in 106 Subcarrier RUs

RU Type/ LTF Tone Mapping	Option a				Option b				Option c			
	EVEN/EVEN or ODD/ODD		ODD/EVEN or EVEN/ODD		EVEN/EVEN or ODD/ODD		ODD/EVEN or EVEN/ODD		EVEN/EVEN or ODD/ODD		ODD/EVEN or EVEN/ODD	
	SC	Gap	SC	Gap	SC	Gap	SC	Gap	SC	Gap	SC	Gap
Low SC	0	14	0	13	0	12	0	15	0	16	0	11
1st Pilot	+14	25	+13	25	+12	25	+15	25	+16	25	+11	25
2nd Pilot	+40	25	+39	25	+38	25	+41	25	+42	25	+37	25
3rd Pilot	+66	25	+65	25	+64	25	+67	25	+68	25	+63	25
4th Pilot	+92	13	+91	14	+90	15	+93	12	+94	11	+89	16
High SC	+105	-	105	-	105	-	105	-	105	-	105	-

FIG. 24

Table 4. Pilot Tone Relative Positions in 108 Subcarrier RUs

RU Type/ LTF Tone Mapping	Option a				Option b				Option c			
	EVEN/EVEN or ODD/ODD		ODD/EVEN or EVEN/ODD		EVEN/EVEN or ODD/ODD		ODD/EVEN or EVEN/ODD		EVEN/EVEN or ODD/ODD		ODD/EVEN or EVEN/ODD	
	SC	Gap	SC	Gap	SC	Gap	SC	Gap	SC	Gap	SC	Gap
Low SC	0	8	0	9	0	10	0	7	0	6	0	11
1st Pilot	+8	17	+9	17	+10	17	+7	17	+6	17	+11	17
2nd Pilot	+26	17	+27	17	+28	17	+25	17	+24	17	+29	17
3rd Pilot	+44	17	+45	17	+46	17	+43	17	+42	17	+47	17
4th Pilot	+62	17	+63	17	+64	17	+61	17	+60	17	+65	17
5th Pilot	+80	17	+81	17	+82	17	+79	17	+78	17	+83	17
6th Pilot	+98	9	+99	8	+100	7	+97	10	+96	11	+101	6
High SC	+107	-	+107	-	+107	-	+107	-	+107	-	+107	-

FIG. 25

Table 5. Pilot Tone Relative Positions in 242 Subcarrier RUs

RU Type/ LTF Tone Mapping	20MHz Bandwidth				40, 80, or 160MHz Bandwidth							
	Opt. a	Opt. b	a or b	Gap	Option a				Option b			
	LTF EVEN	LTF EVEN	LTF ODD		EVEN/EVEN or ODD/ODD		ODD/EVEN or EVEN/ODD		EVEN/EVEN or ODD/ODD		ODD/EVEN or EVEN/ODD	
	SC	SC	SC		SC	Gap	SC	Gap	SC	Gap	SC	Gap
Low SC		-122		18/20/19	0	18	0	19	0	20	0	19
1st Pilot	-104	-102	-103	27	18	27	19	27	20	27	19	27
2nd Pilot	-76	-74	-75	35	46	35	47	35	48	35	47	35
3rd Pilot	-40	-38	-39	37	82	27	83	27	84	27	83	27
4th Pilot	-12	-10	-11	23/19/21	110	19	111	19	112	17	111	17
5th Pilot	+12	+10	+11	27	130	27	131	27	130	27	119	27
6th Pilot	+40	+38	+39	35	158	35	159	35	158	35	157	35
7th Pilot	+76	+74	+75	37	194	27	195	27	194	27	193	27
8th Pilot	+104	+102	+103	18/20/19	222	19	223	18	222	19	221	20
High SC		+122		-	+241	-	+241	-	+241	-	+241	-

FIG. 26

Table 6. Pilot Tone Relative Positions in 242 Subcarrier Resource Blocks

Block Type/ LTF Tone Mapping	Option A		Option B		Option C	
	EVEN/EVEN or ODD/ODD	ODD/EVEN or EVEN/ODD	EVEN/EVEN or ODD/ODD	ODD/EVEN or EVEN/ODD	EVEN/EVEN or ODD/ODD	ODD/EVEN or EVEN/ODD
First Pilot	+16	+15	+18	+17	+14	+13
Second Pilot	+46	+45	+48	+47	+44	+43
Third Pilot	+76	+75	+78	+77	+74	+73
Fourth Pilot	+106	+105	+108	+107	+104	+103
Fifth Pilot	+136	+135	+138	+137	+134	+133
Sixth Pilot	+166	+165	+168	+167	+164	+163
Seventh Pilot	+192	+195	+198	+197	+194	+193
Eighth Pilot	+226	+225	+228	+227	+224	+223

FIG. 27

Table 7. Pilot Tone Relative Positions in Center 242 Subcarrier Resource Blocks

LTF Tone Mapping	Option A		Option B		Option C	
	EVEN	ODD	EVEN	ODD	EVEN	ODD
First Pilot	$-f_0-104$	$-f_0-105$	$-f_0-102$	$-f_0-103$	$-f_0-106$	$-f_0-107$
Second Pilot	$-f_0-74$	$-f_0-75$	$-f_0-72$	$-f_0-73$	$-f_0-76$	$-f_0-77$
Third Pilot	$-f_0-44$	$-f_0-45$	$-f_0-42$	$-f_0-43$	$-f_0-46$	$-f_0-47$
Fourth Pilot	$-f_0-14$	$-f_0-15$	$-f_0-12$	$-f_0-13$	$-f_0-16$	$-f_0-17$
Fifth Pilot	$+f_0+14$	$+f_0+15$	$+f_0+12$	$+f_0+13$	$+f_0+16$	$+f_0+17$
Sixth Pilot	$+f_0+44$	$+f_0+45$	$+f_0+42$	$+f_0+43$	$+f_0+46$	$+f_0+47$
Seventh Pilot	$+f_0+74$	$+f_0+75$	$+f_0+73$	$+f_0+73$	$+f_0+76$	$+f_0+77$
Eighth Pilot	$+f_0+104$	$+f_0+105$	$+f_0+102$	$+f_0+103$	$+f_0+106$	$+f_0+107$

FIG. 28

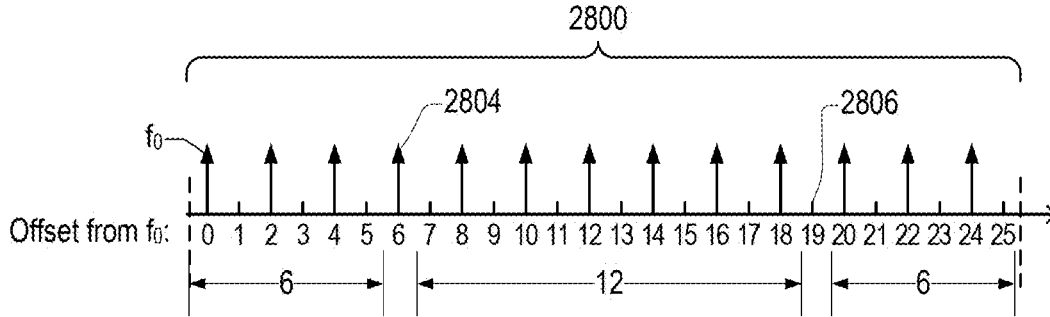

FIG. 29

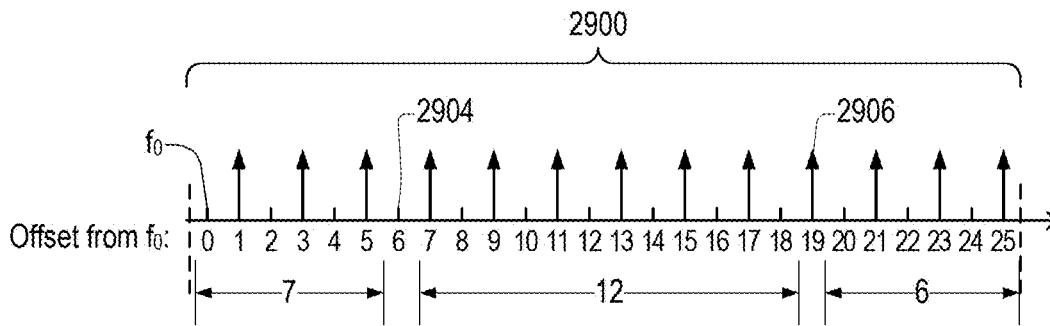

FIG. 30

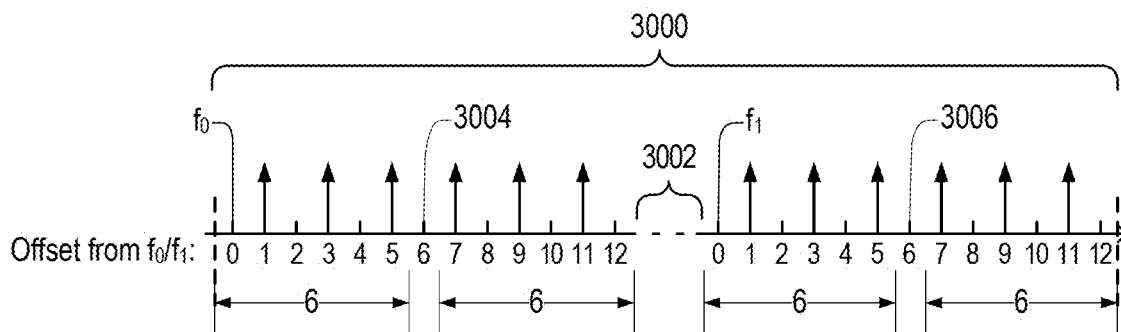

FIG. 31

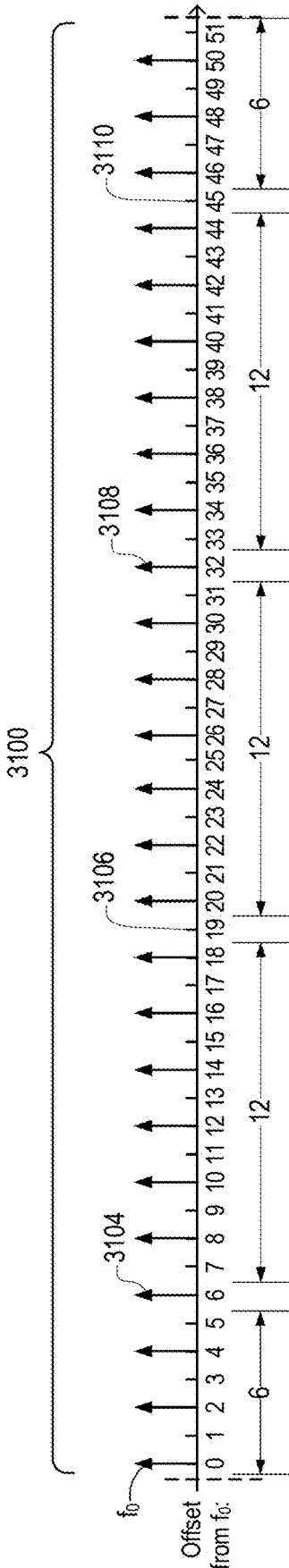
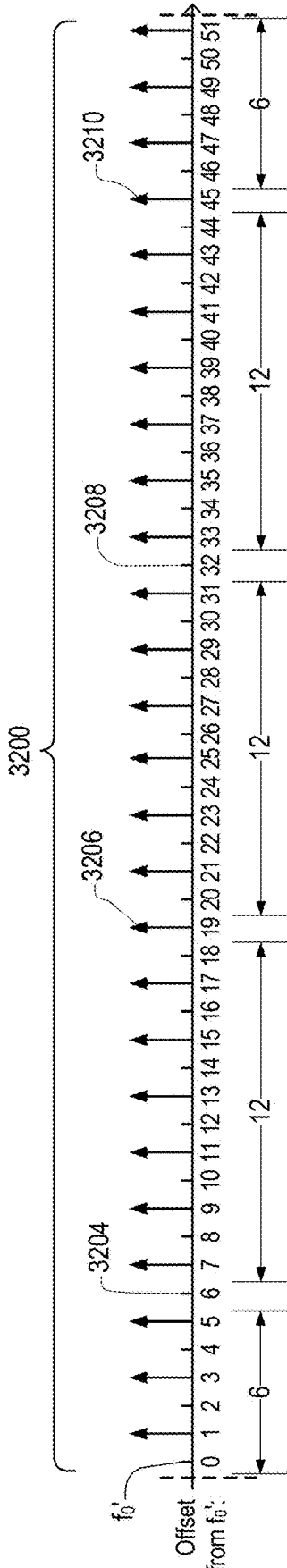

FIG. 32



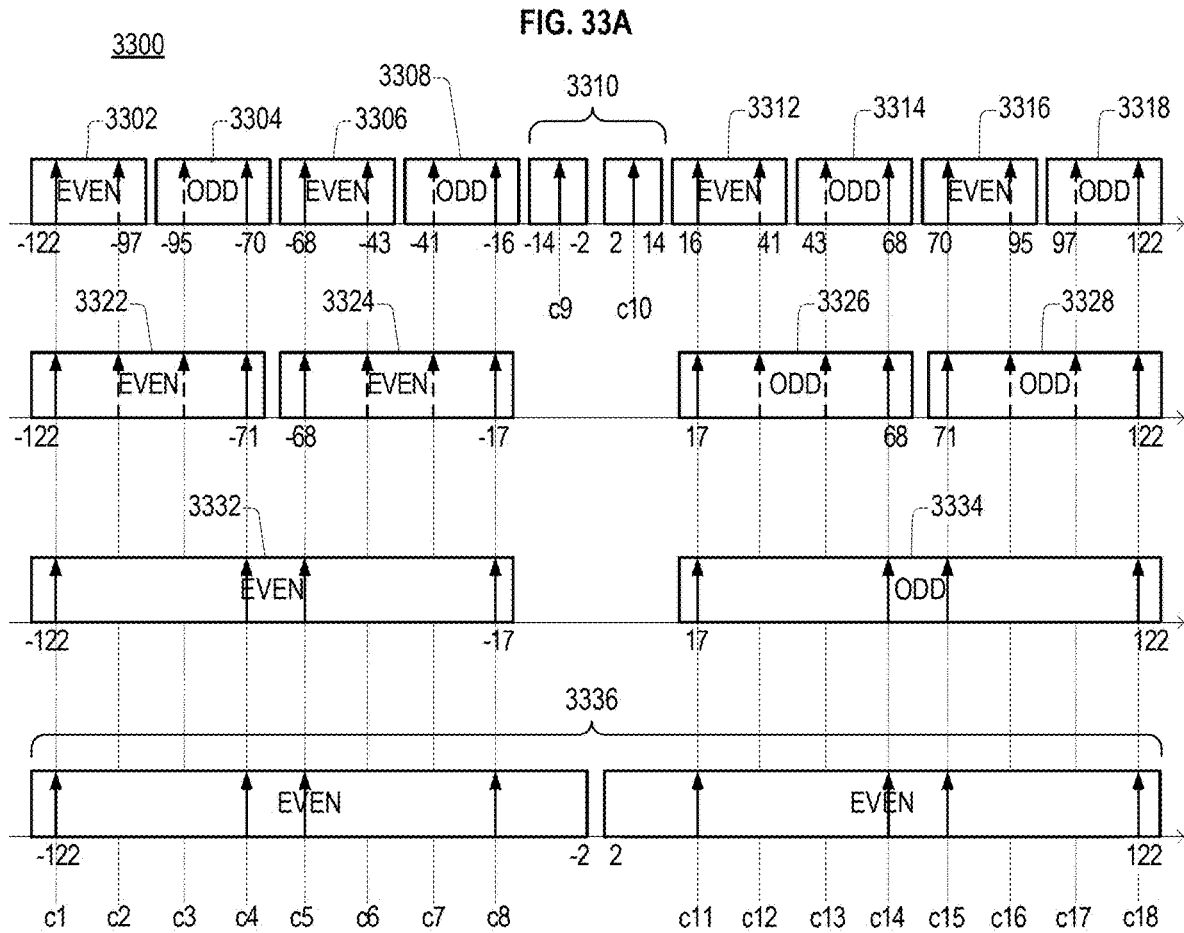

FIG. 33B

Table 9. Pilot Tone Relative Positions

Tone	Position	Tone	Position
c1	-116	c18	+116
c2	-102 or -104	c17	+102 or +104
c3	-90 or -88	c16	+90 or +88
c4	-76	c15	+76
c5	-62	c14	+62
c6	-48 or -50	c13	+48 or +50
c7	-36 or -34	c12	+36 or +34
c8	-22	c11	+22
c9	-8	c10	+8

FIG. 34

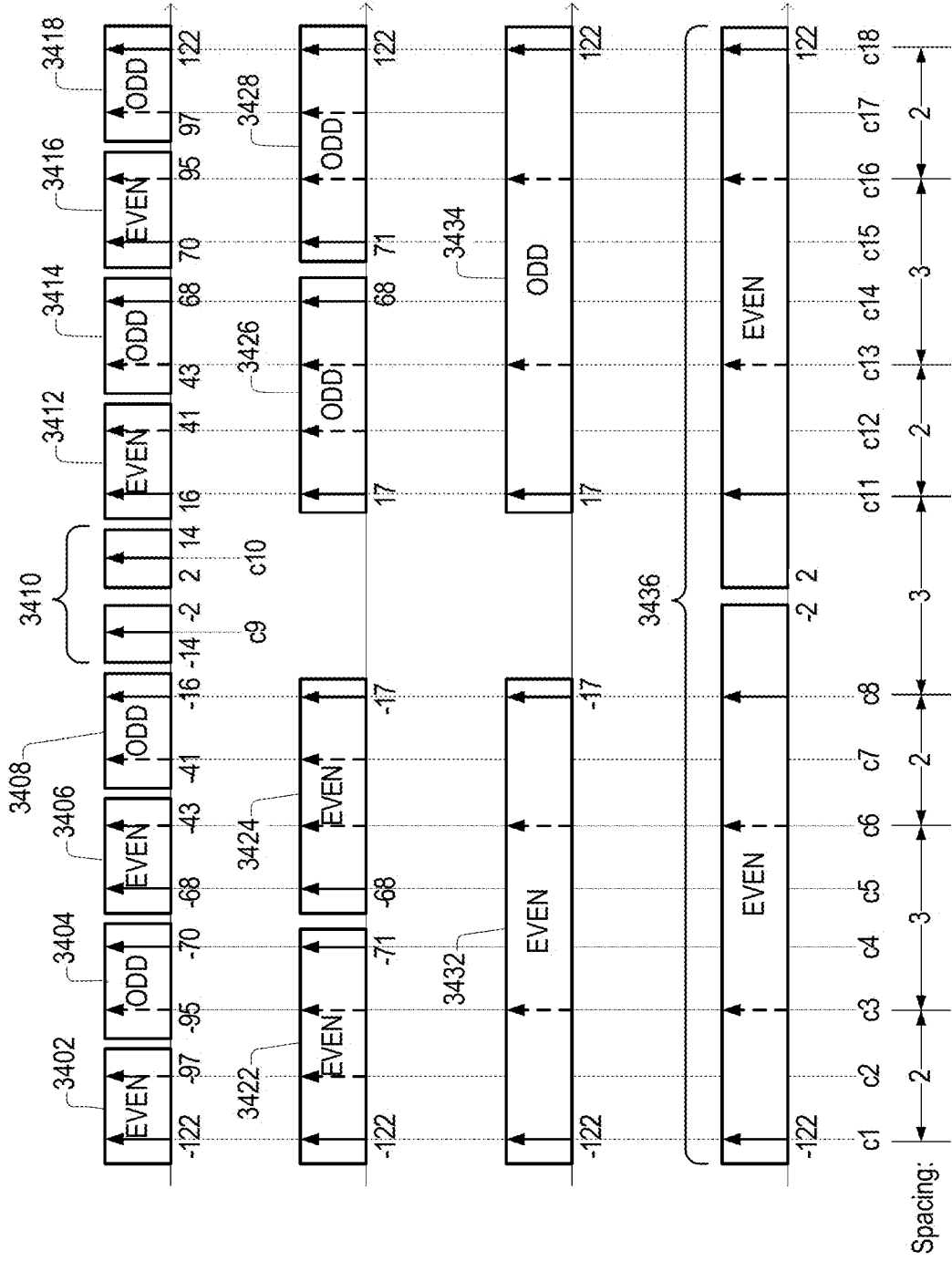

FIG. 35

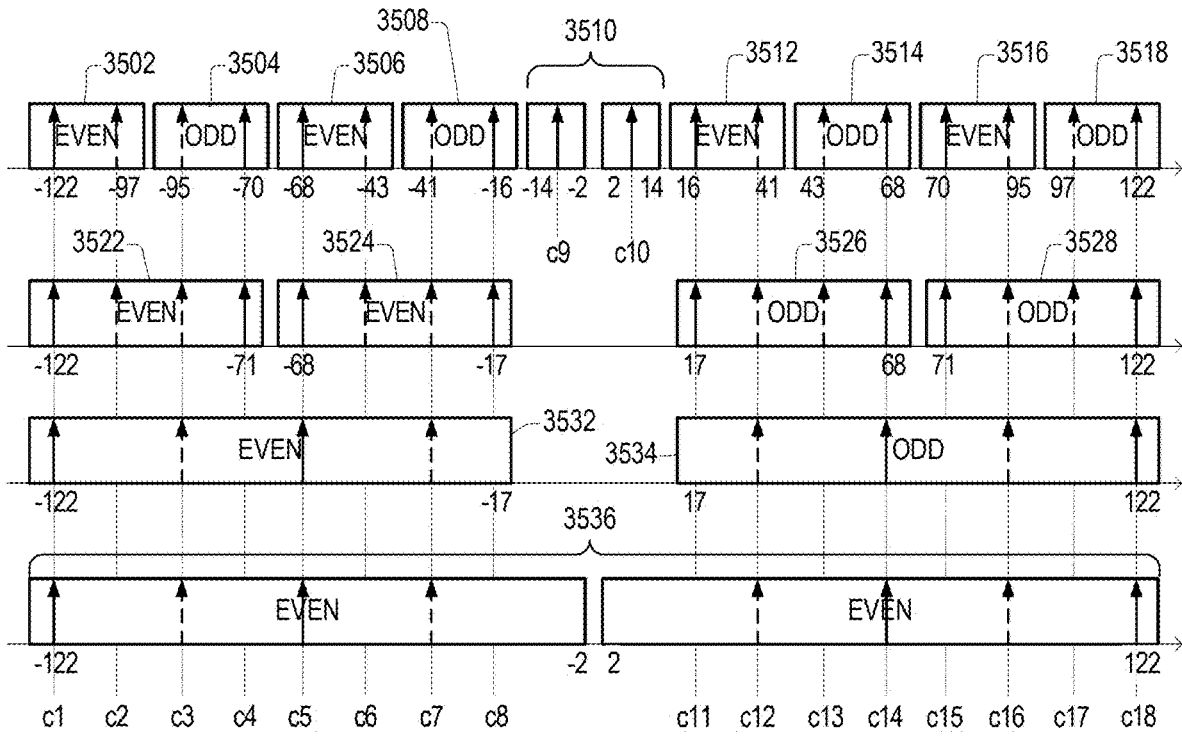

FIG. 36

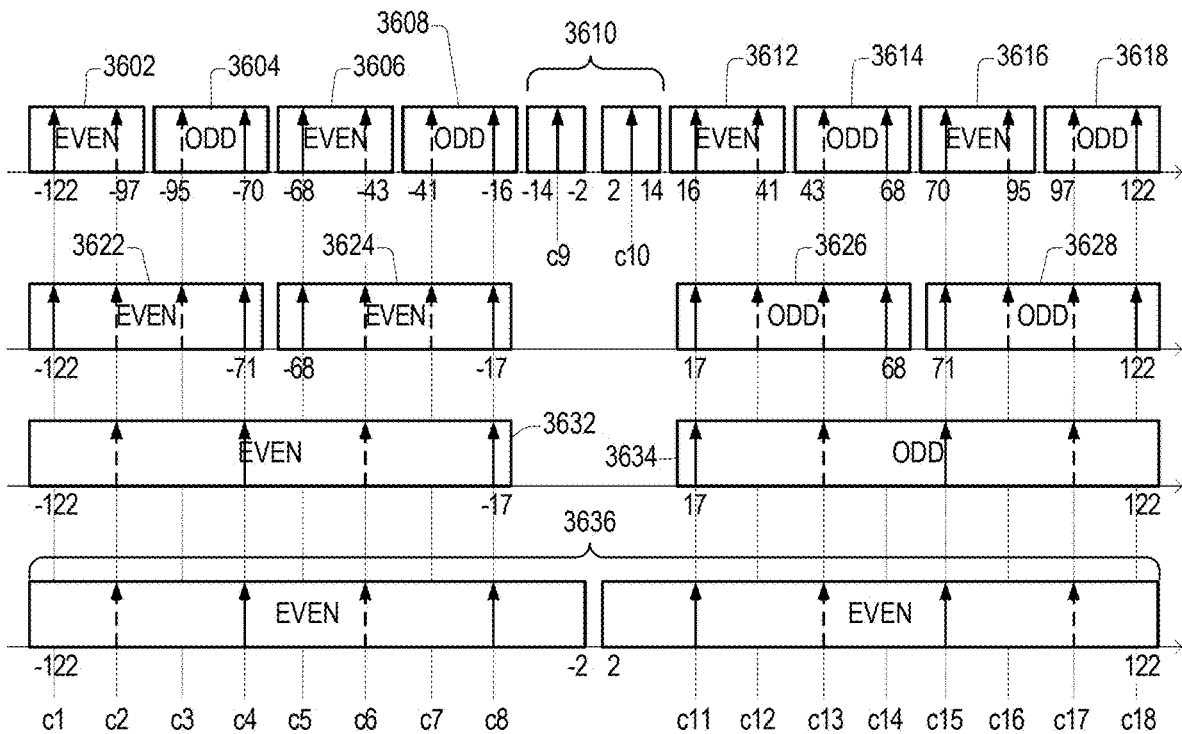

FIG. 37

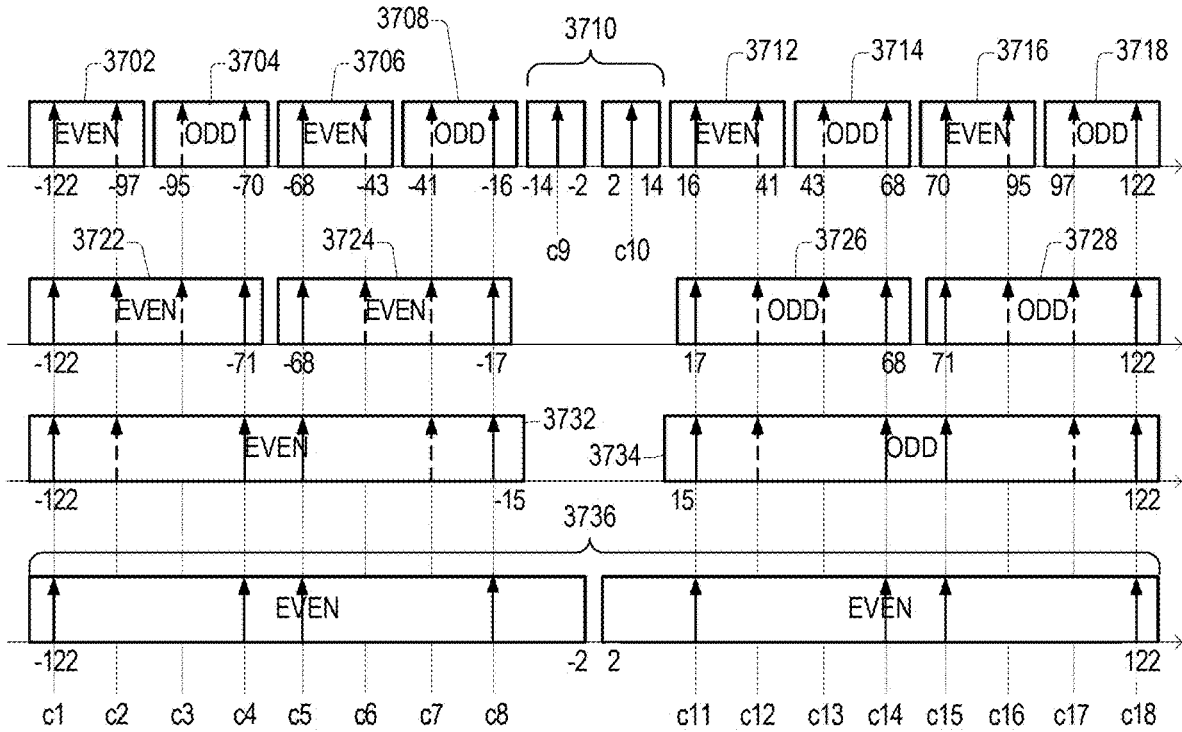

FIG. 38

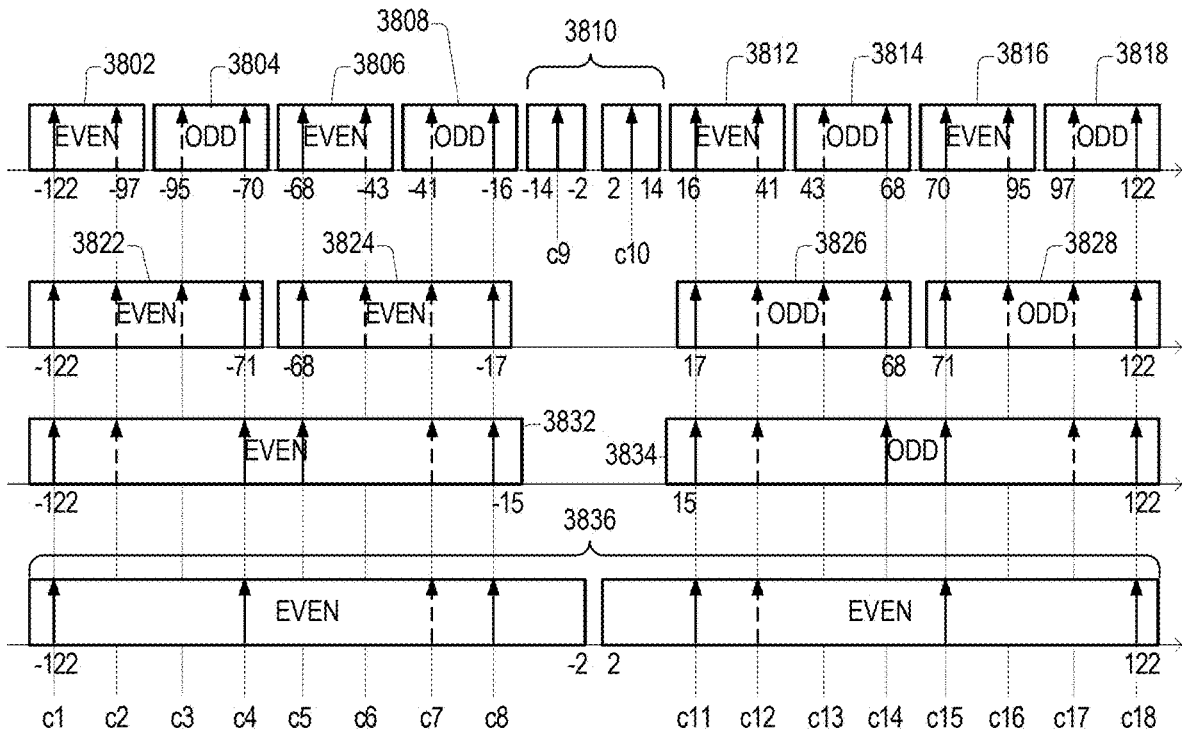

FIG. 39

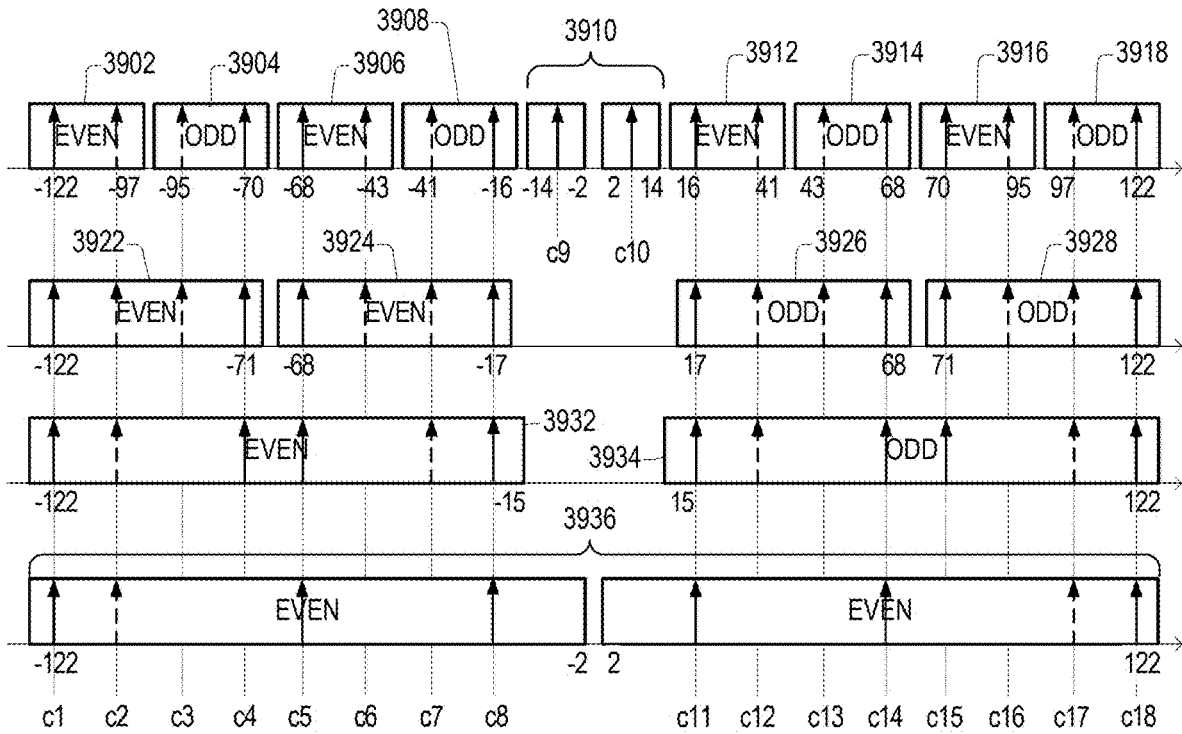

FIG. 40

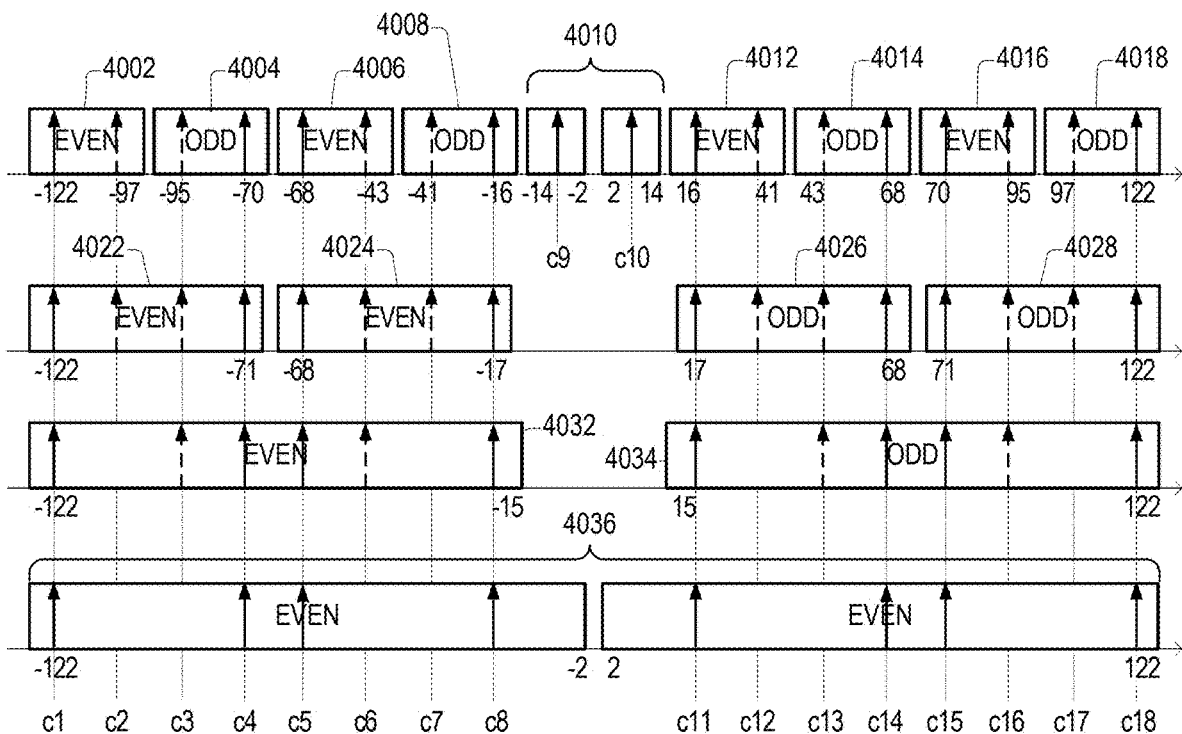

FIG. 41

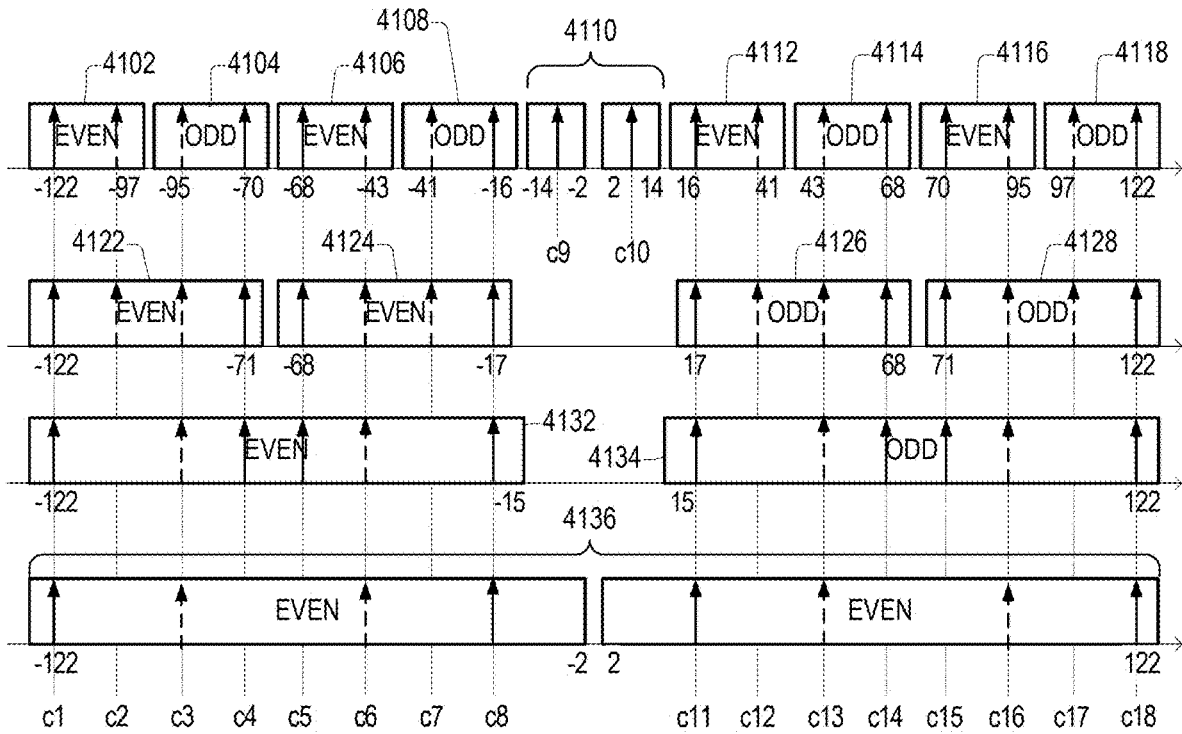

FIG. 42

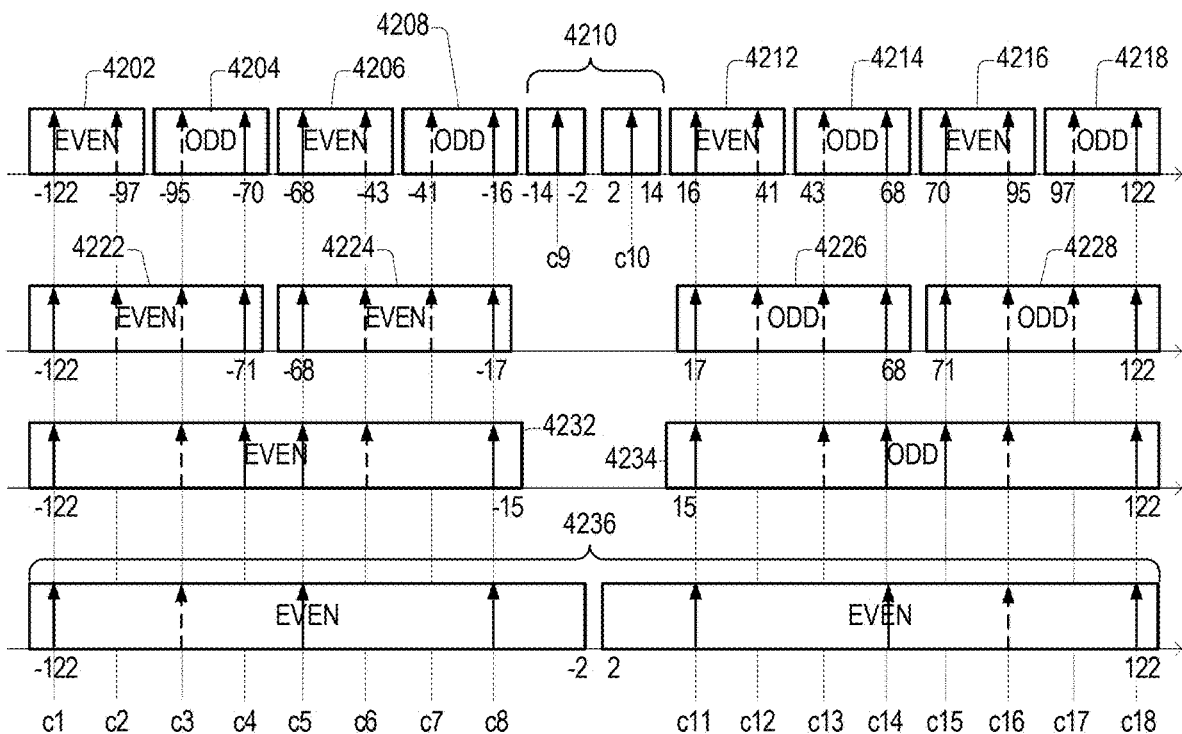

FIG. 43

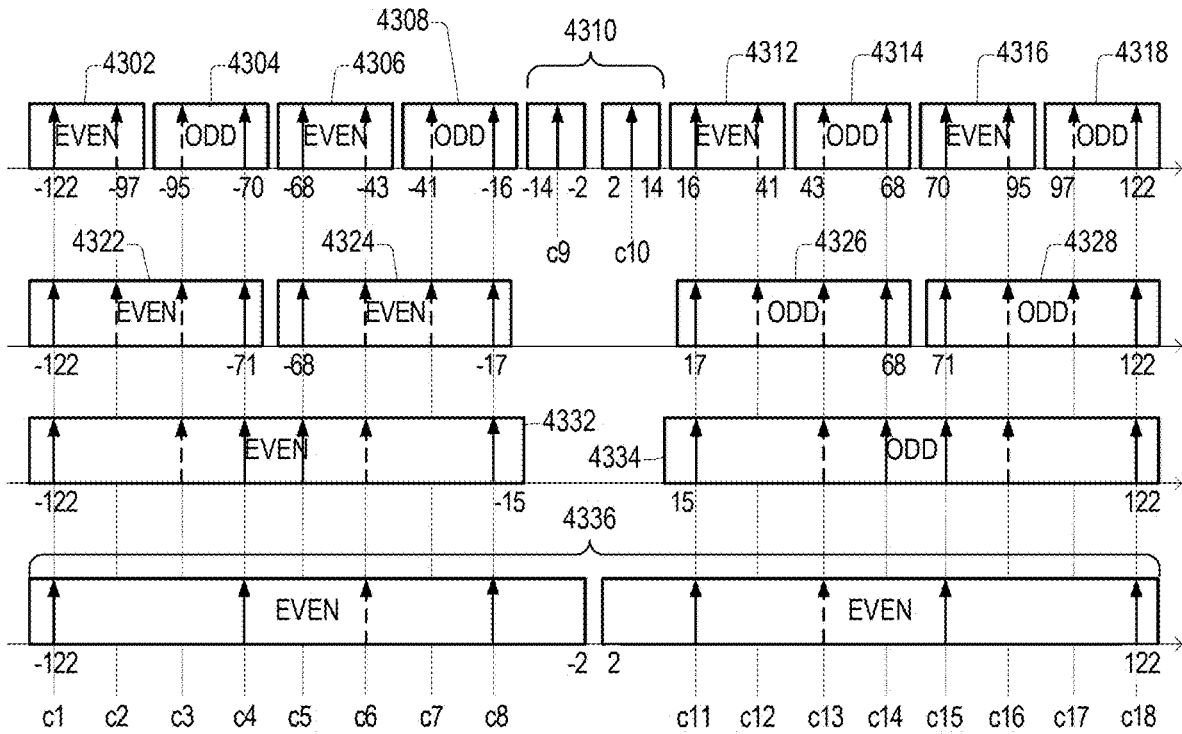

FIG. 44

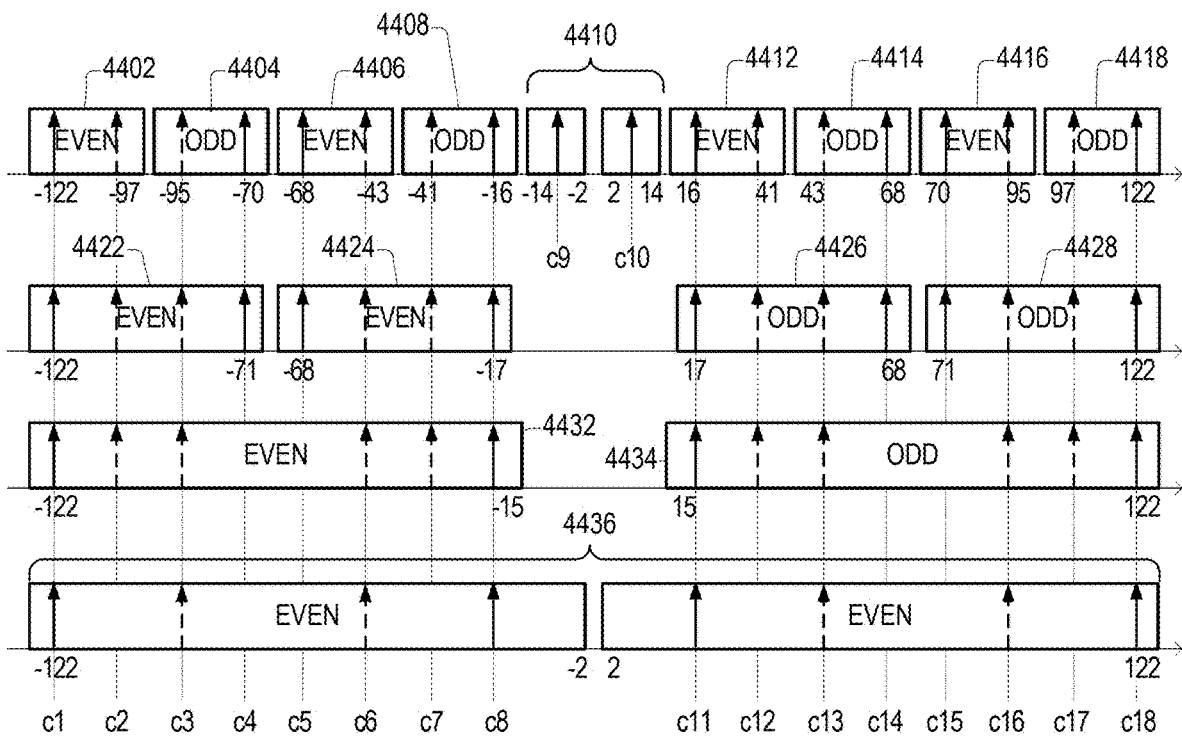

FIG. 45

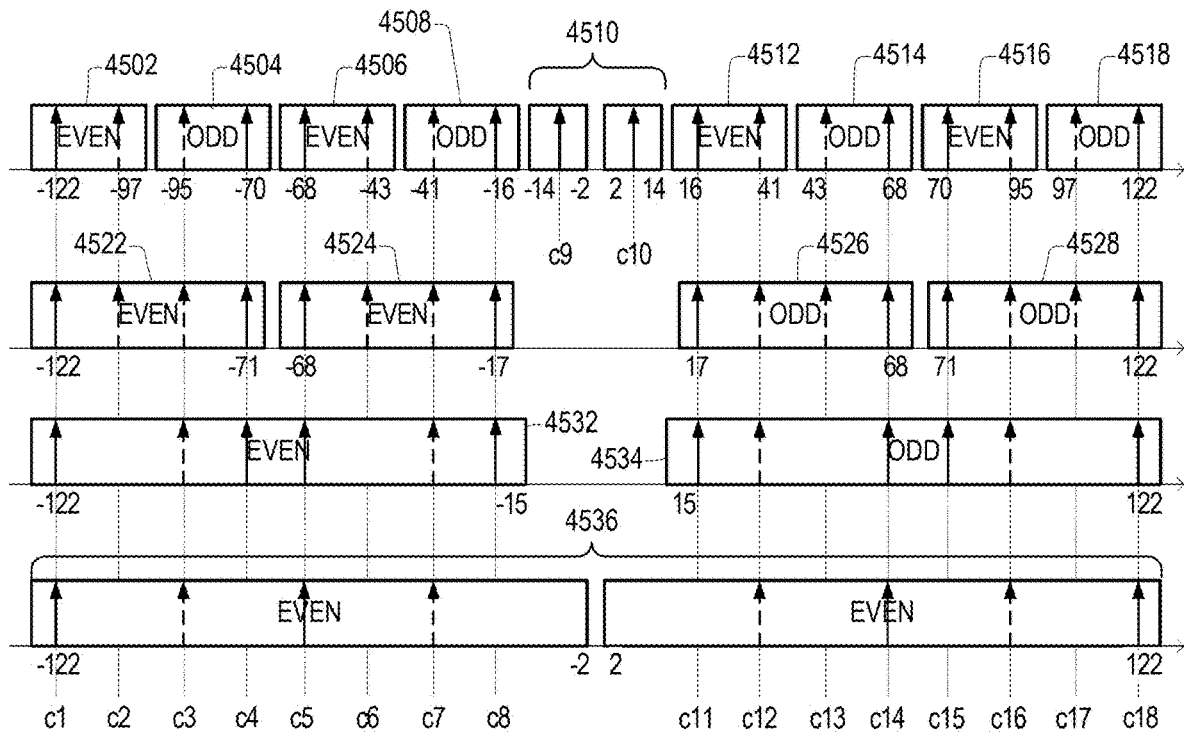

FIG. 46A

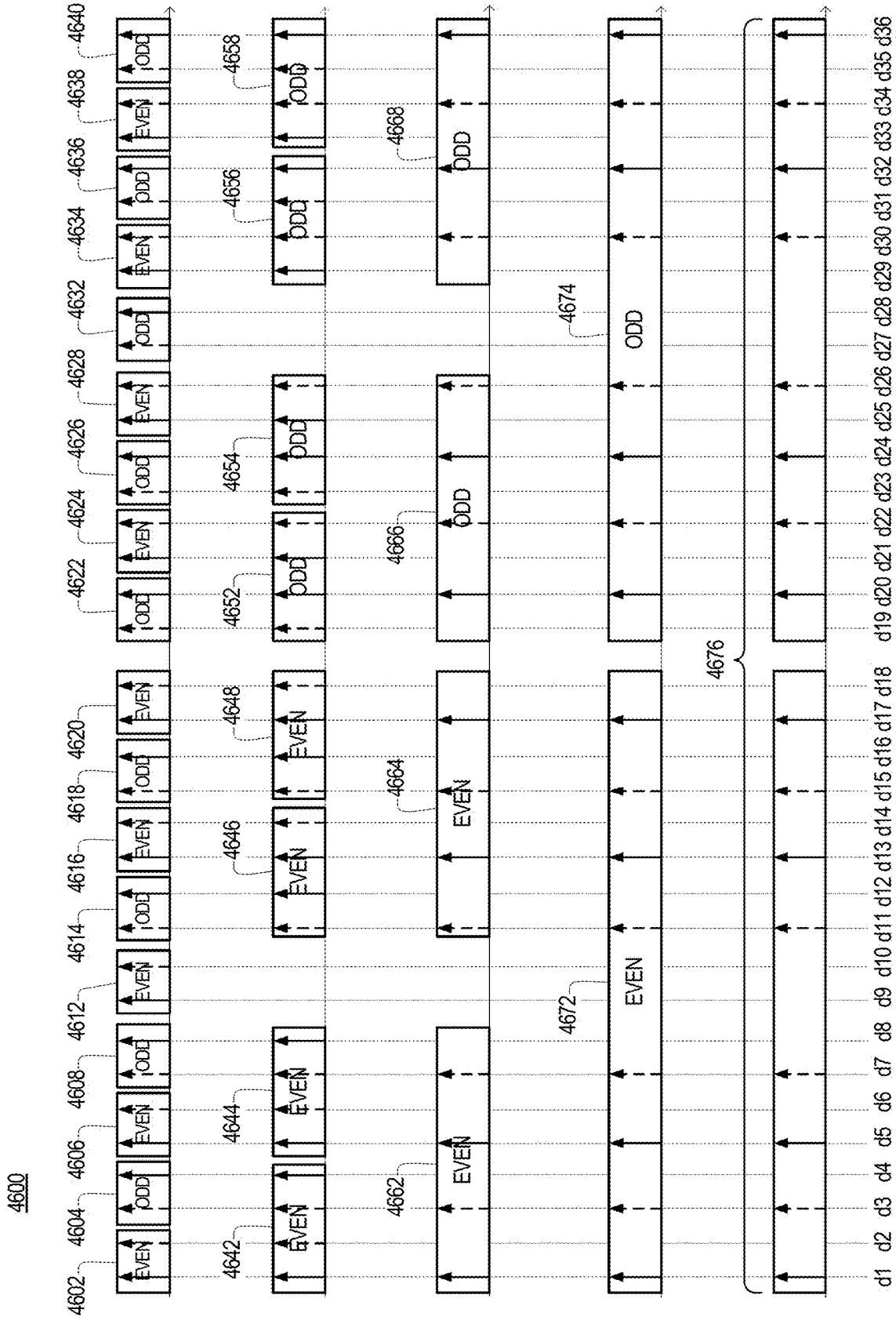

FIG. 46B

Table 10. Pilot Tone Relative Positions

Pilot	Position	Pilot	Position
d1	-238	d36	+238
d2	-224 or -226	d35	+224 or +226
d3	-212 or -210	d34	+212 or +210
d4	-198	d33	+198
d5	-184	d32	+184
d6	-170 or -172	d31	+170 or +172
d7	-158 or -156	d30	+158 or +156
d8	-144	d29	+144
d9	-130	d28	+130
d10	-116 or -118	d27	+116 or +118
d11	-104 or -102	d26	+104 or +102
d12	-90	d25	+90
d13	-78	d24	+78
d14	-64 or -62	d23	+64 or +62
d15	-50 or -48	d22	+50 or +48
d16	-36	d21	+36
d17	-24	d20	+24
d18	-10 or -8	d19	+10 or +8

FIG. 47

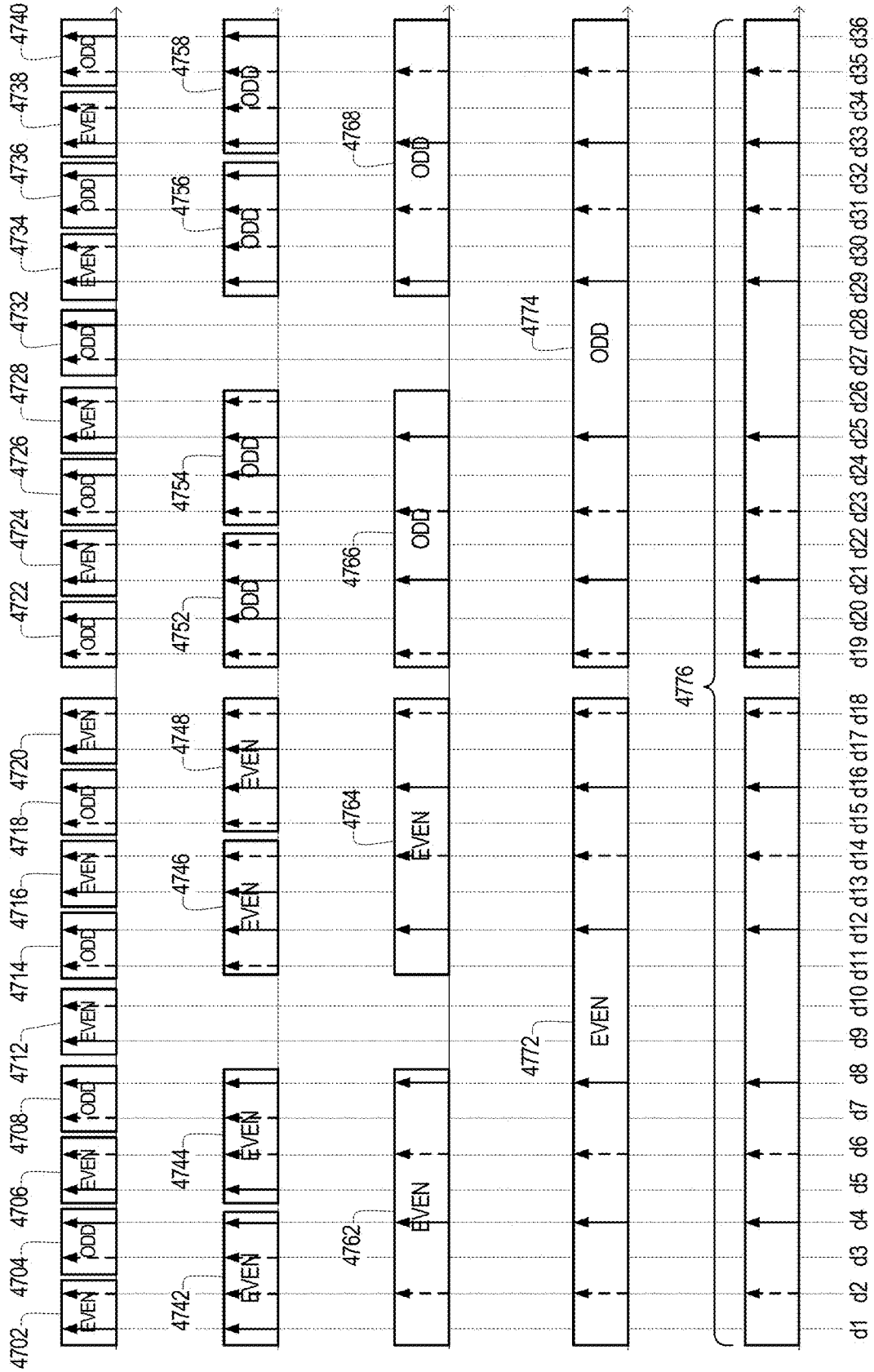

FIG. 48

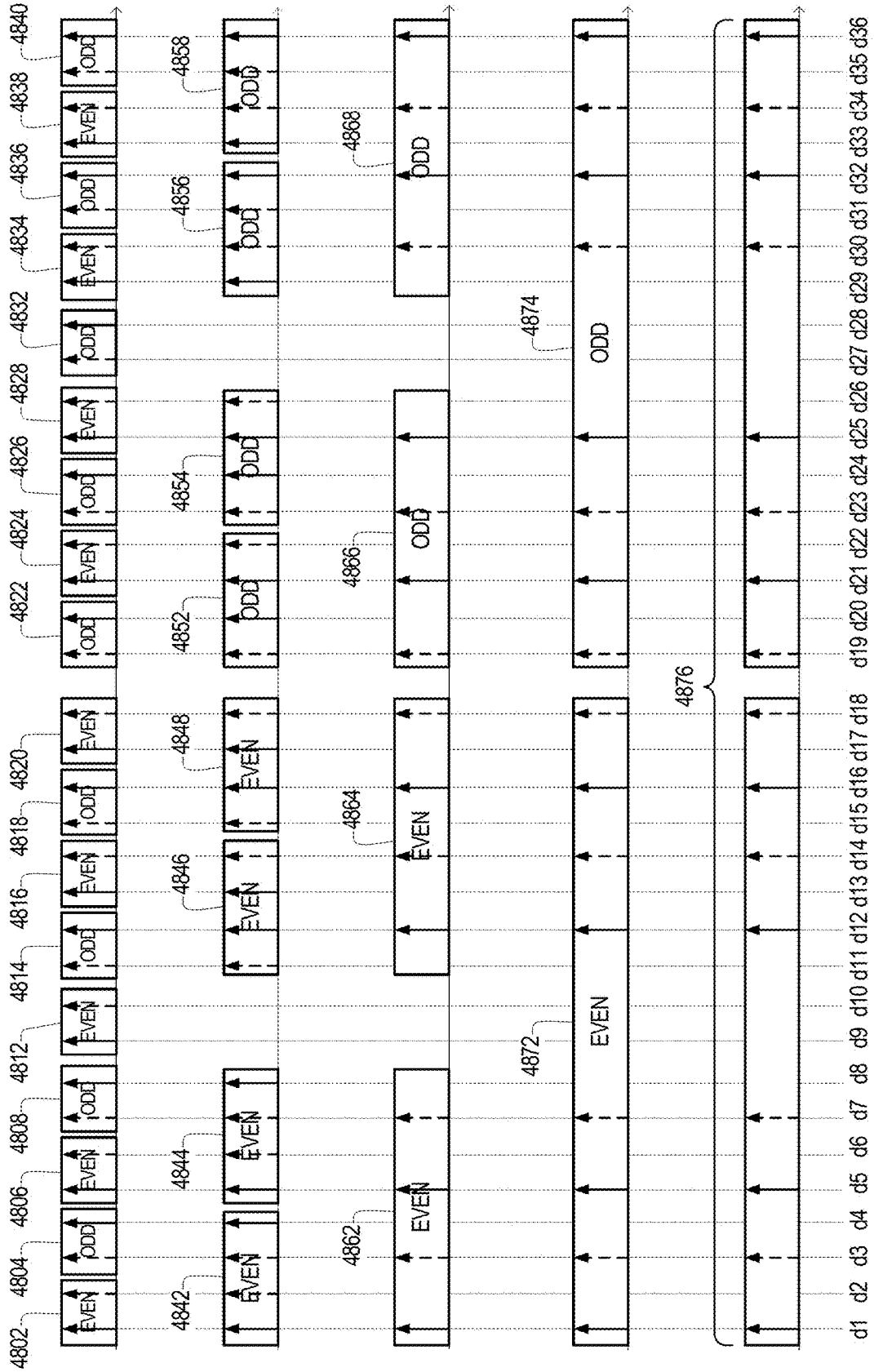

FIG. 49

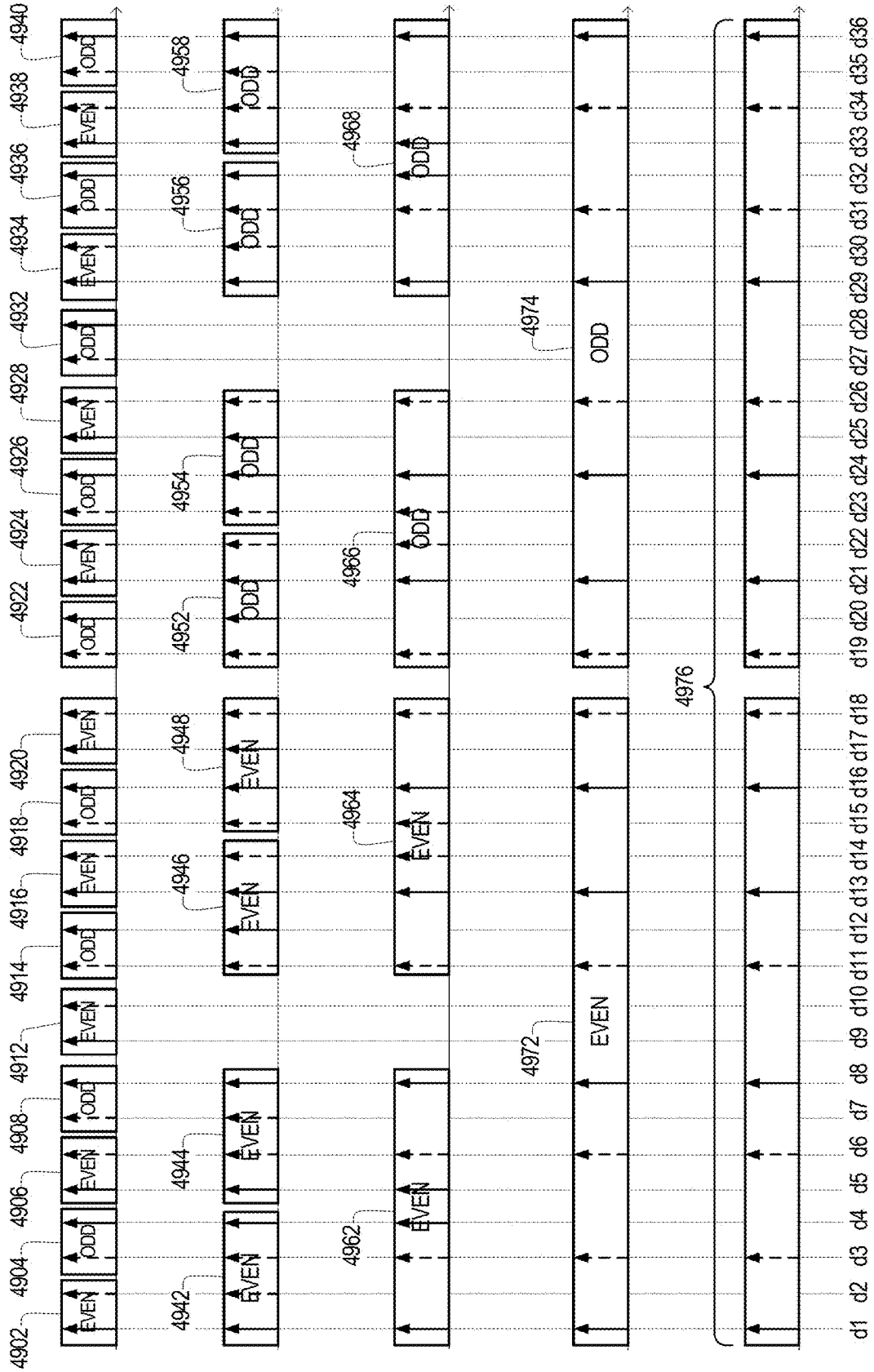

FIG. 50

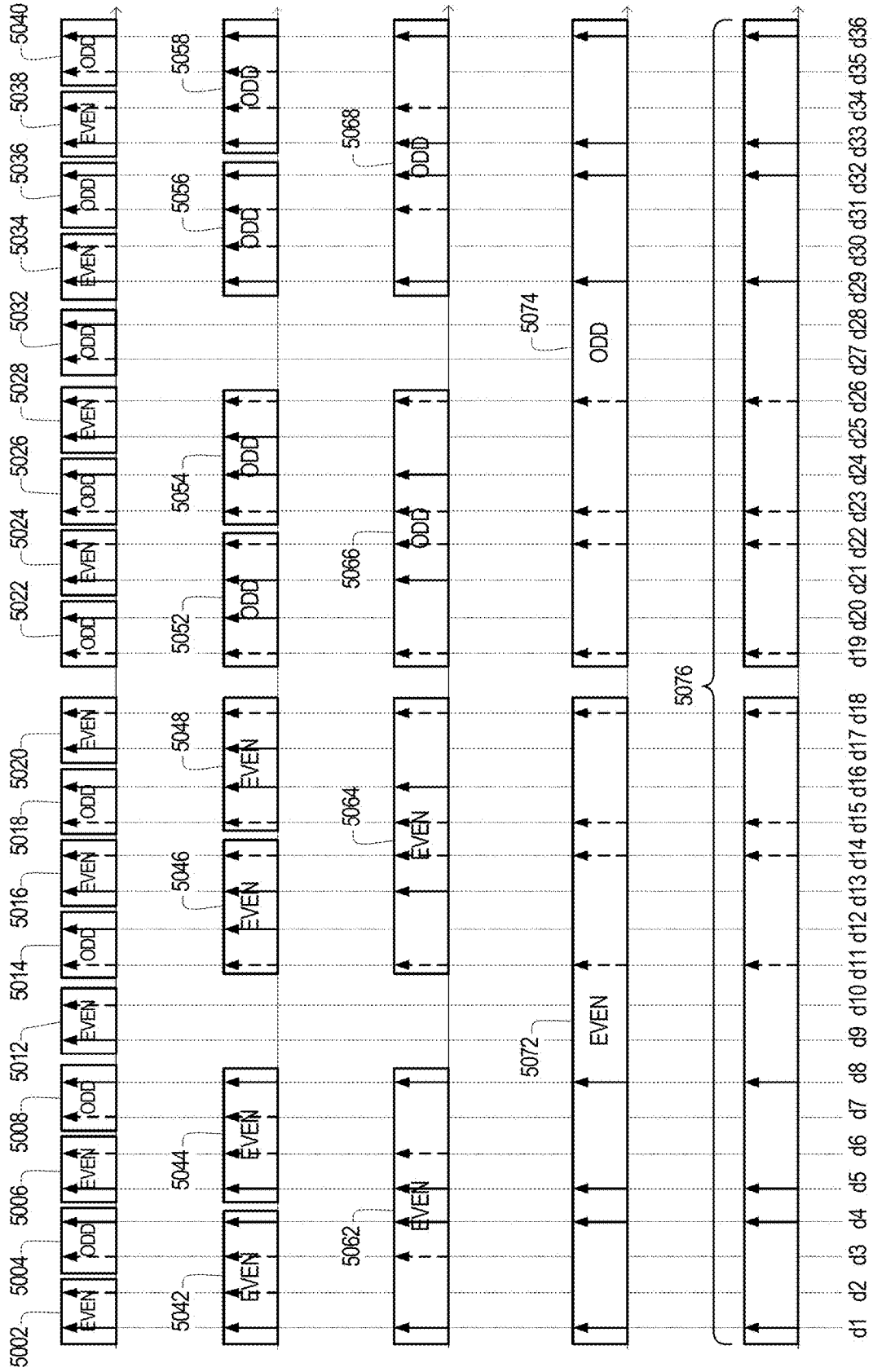

FIG. 51

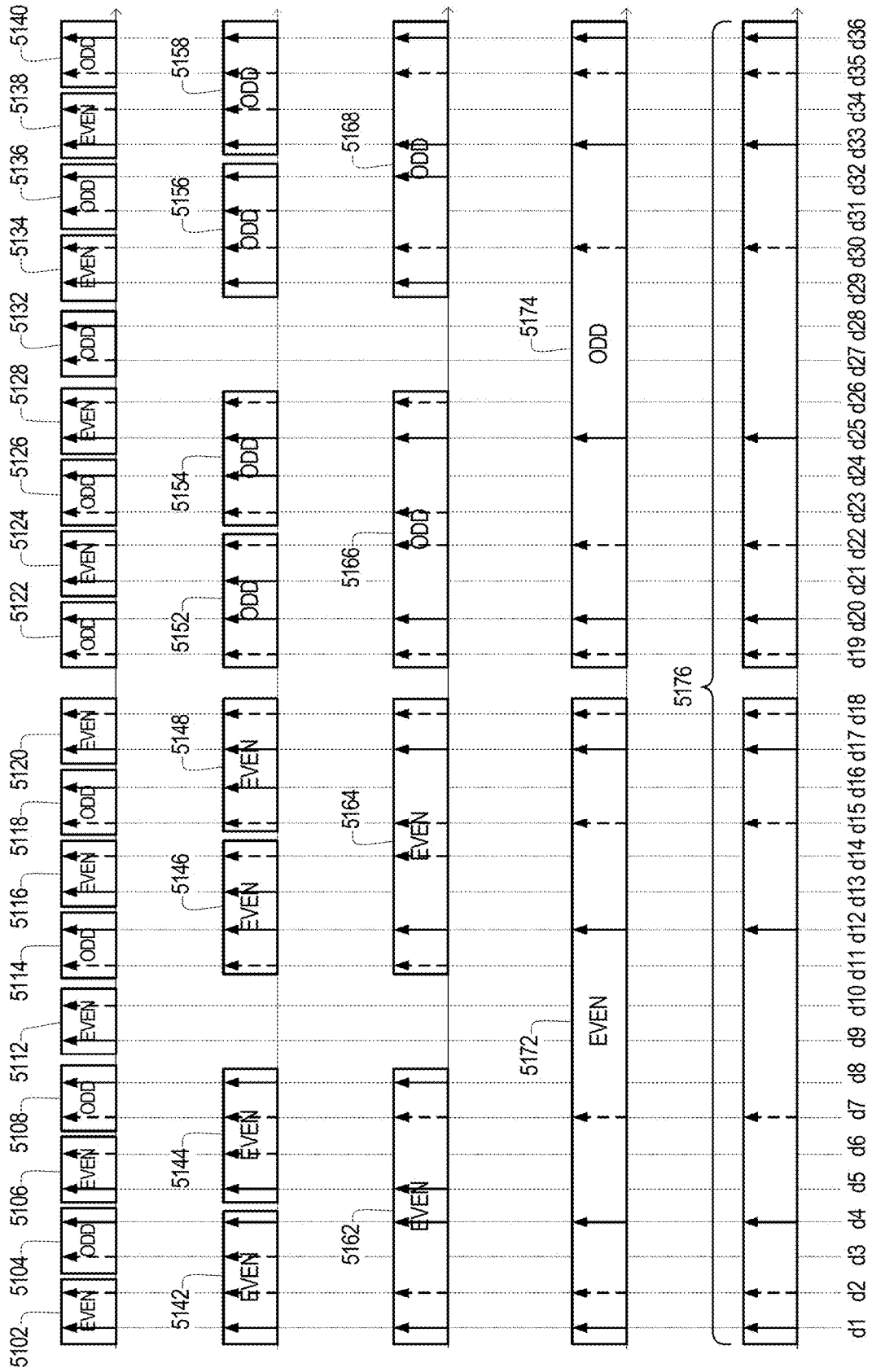

FIG. 52

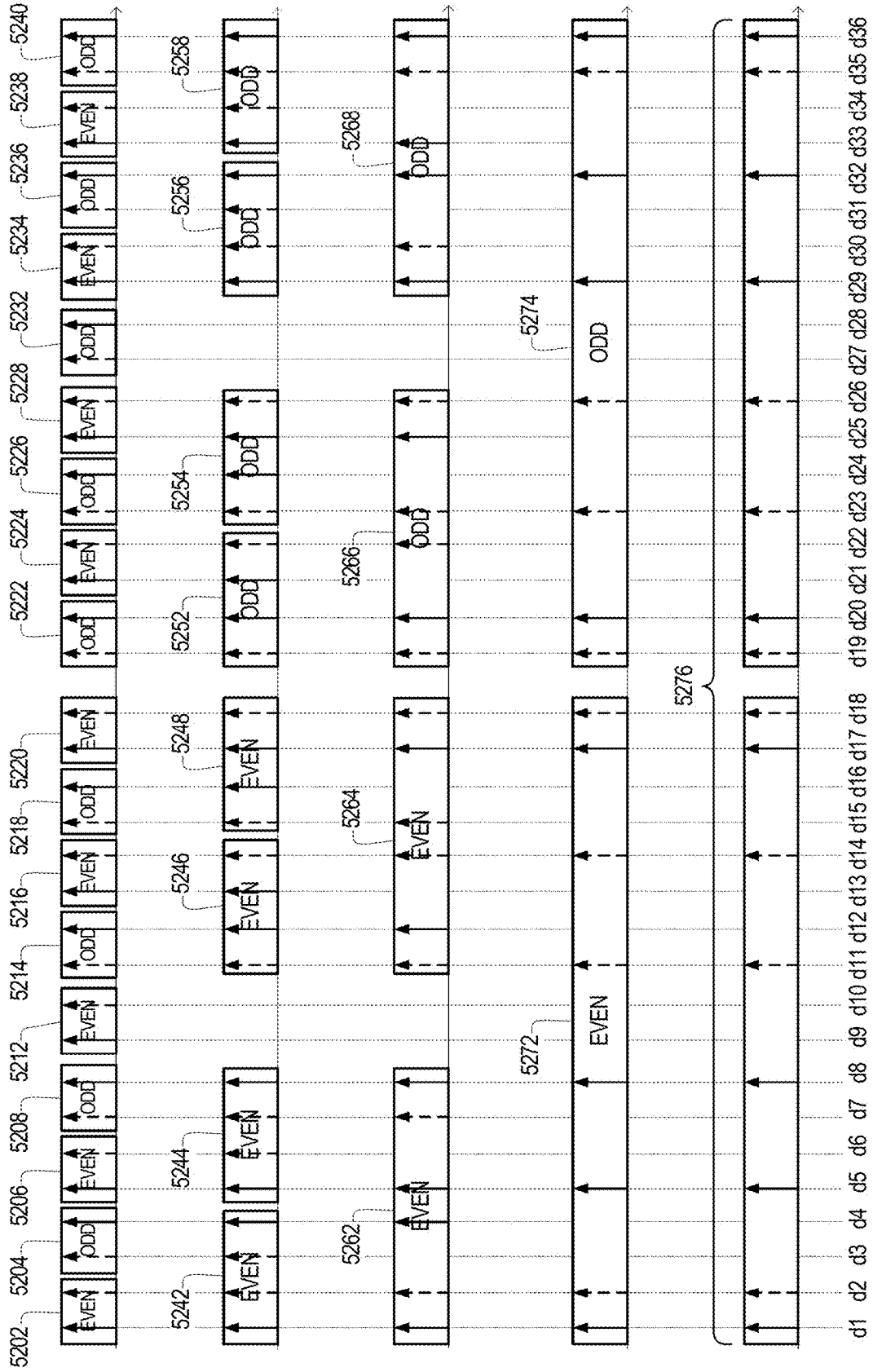
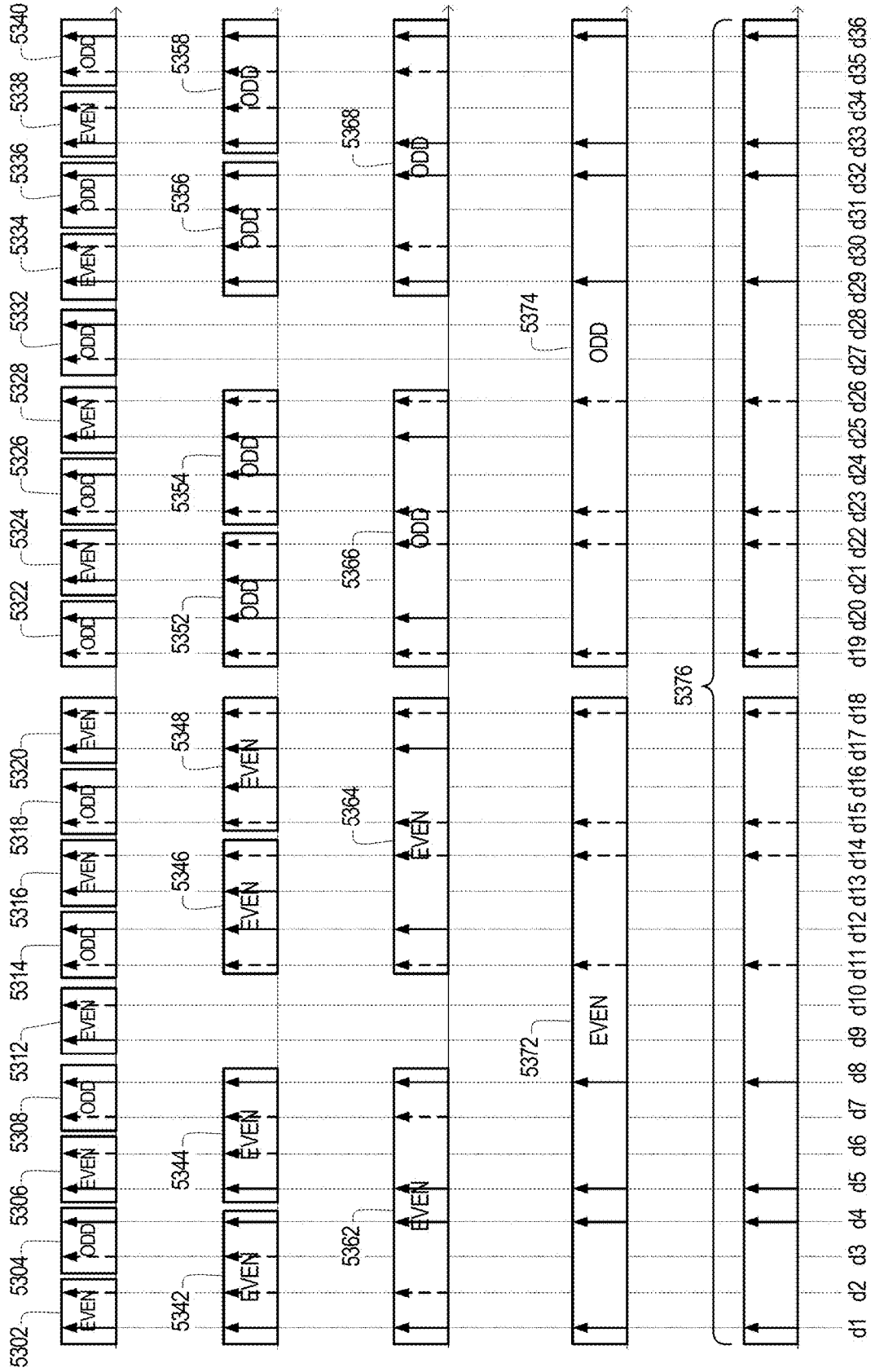

FIG. 53



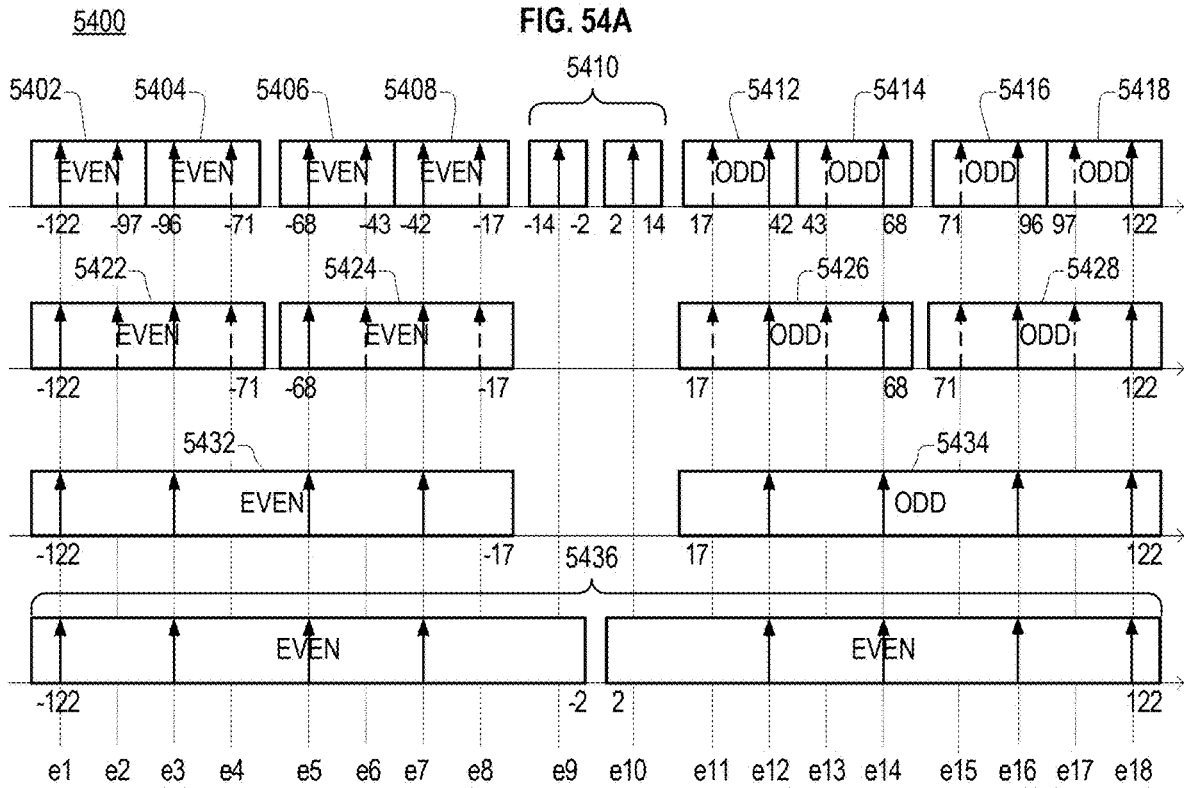

FIG. 54B

Table 11. Pilot Tone Relative Positions

Pilot	Position	Pilot	Position
e1	-116	e18	+116
e2	-102 or -104	e17	+102 or +104
e3	-90	e16	+90
e4	-76 or -78	e15	+76 or +78
e5	-62	e14	+62
e6	-48 or -50	e13	+48 or +50
e7	-36	e12	+36
e8	-22 or -24	e11	+22 or +24
e9	-8	e10	+8

FIG. 55

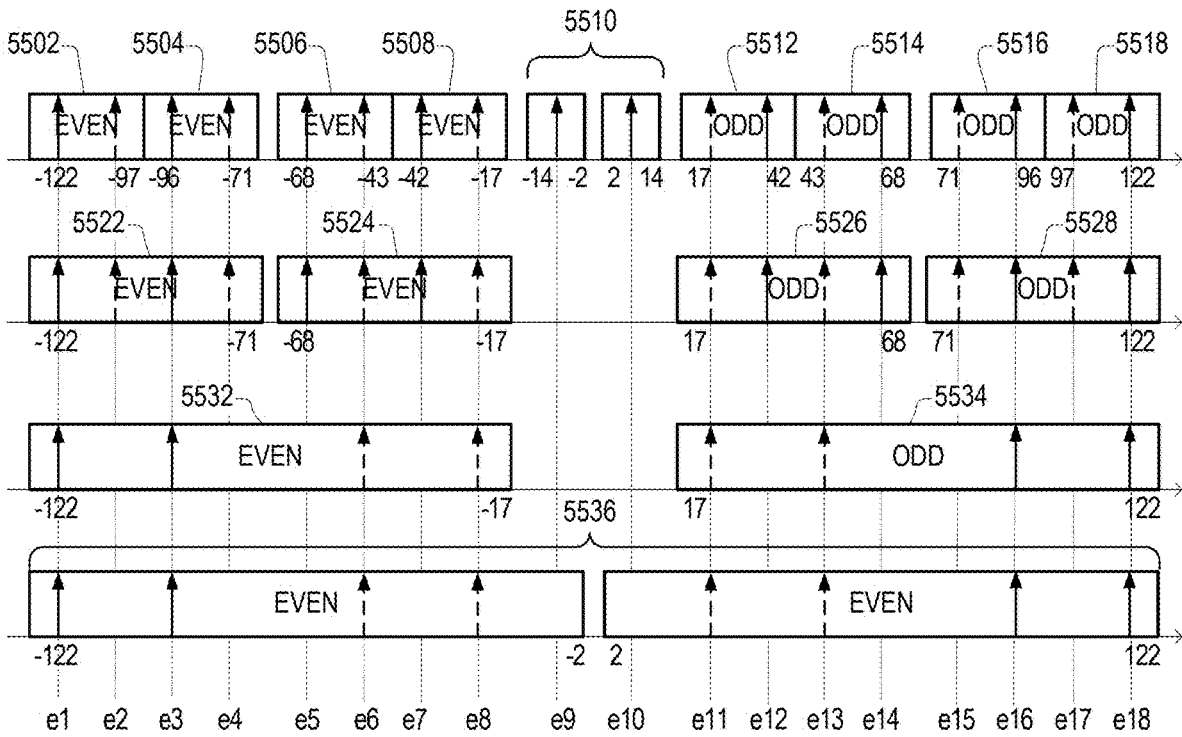

FIG. 56

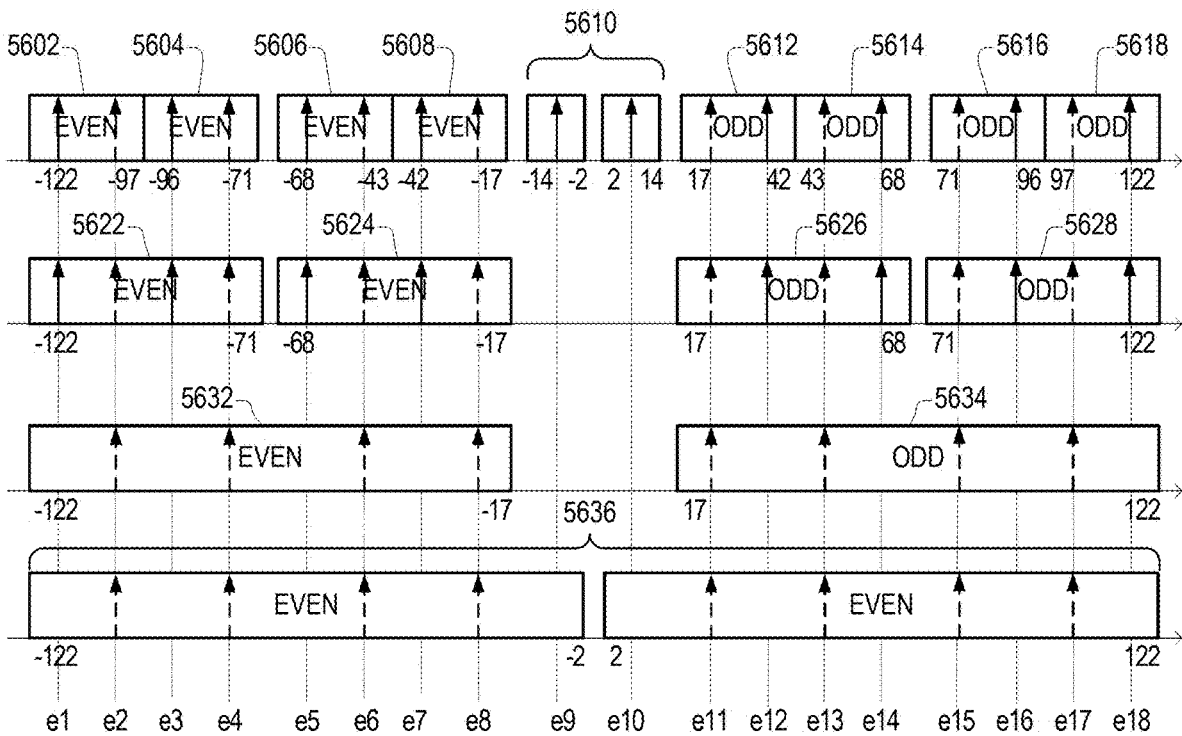

FIG. 59A

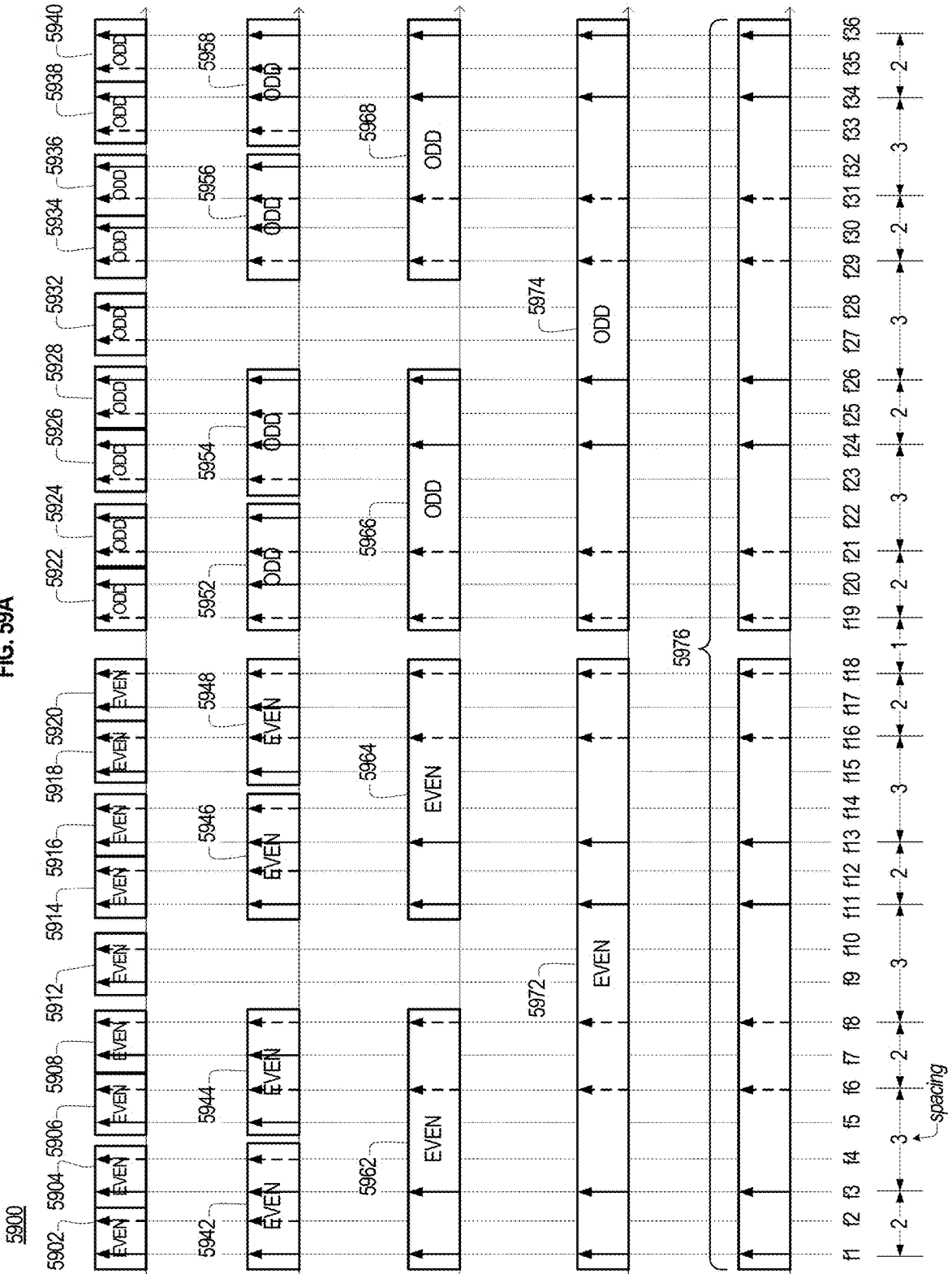

FIG. 59B

Table 12. Pilot Tone Relative Positions

Pilot	Position	Pilot	Position
f1	-238	f36	238
f2	-224 or -226	f35	224 or 226
f3	-212	f34	212
f4	-198 or -200	f33	198 or 200
f5	-184	f32	184
f6	-170 or -172	f31	170 or 172
f7	-158	f30	158
f8	-144 or -146	f29	144 or 146
f9	-130	f28	130
f10	-116 or -118	f27	116 or 118
f11	-104	f26	104
f12	-90 or -92	f25	90 or 92
f13	-78	f24	78
f14	-64 or -66	f23	64 or 66
f15	-50	f22	50
f16	-36 or -38	f23	36 or 38
f17	-24	f20	24
f18	-10 or -12	f19	10 or 12

FIG. 60

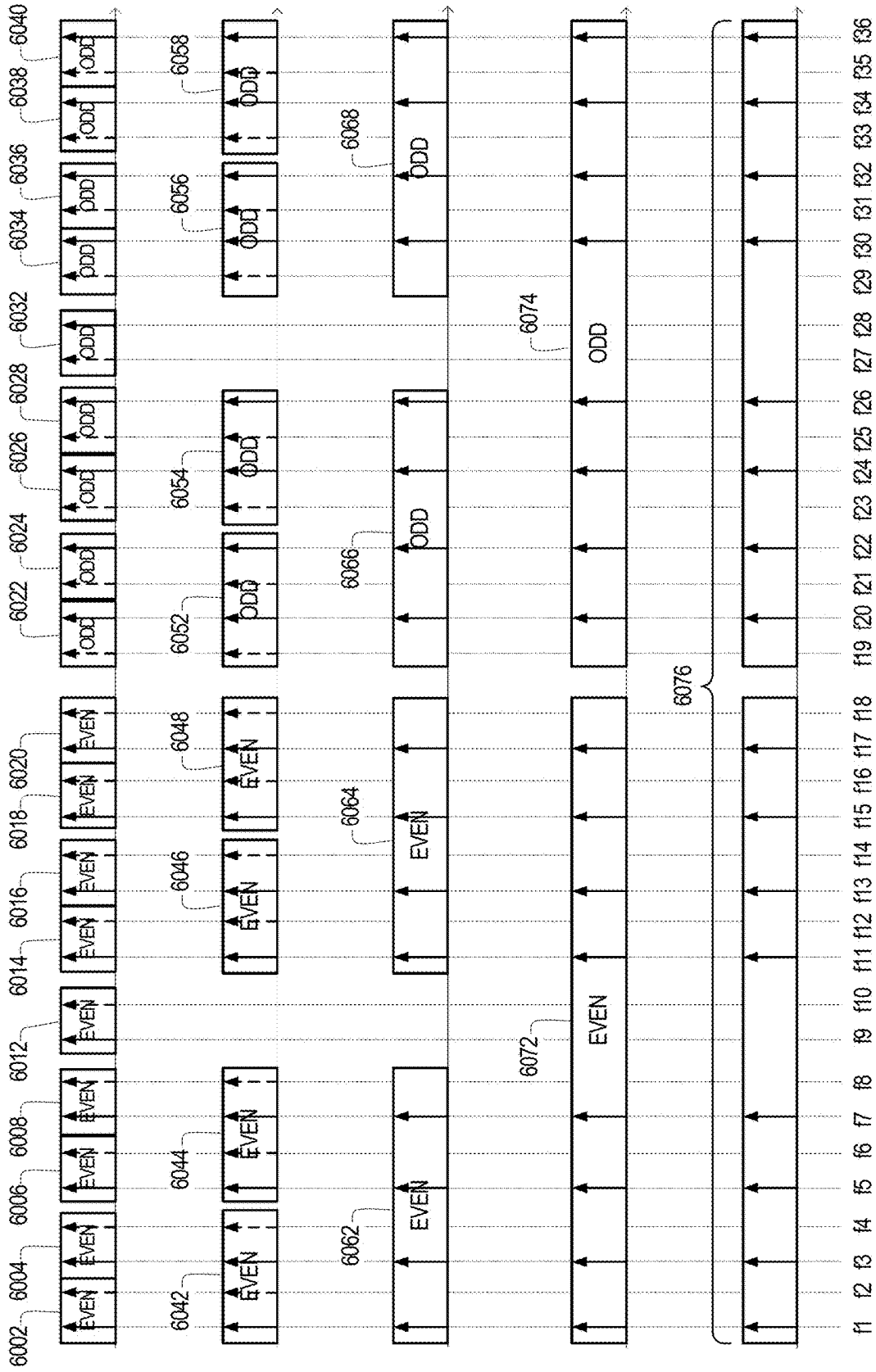

FIG. 61

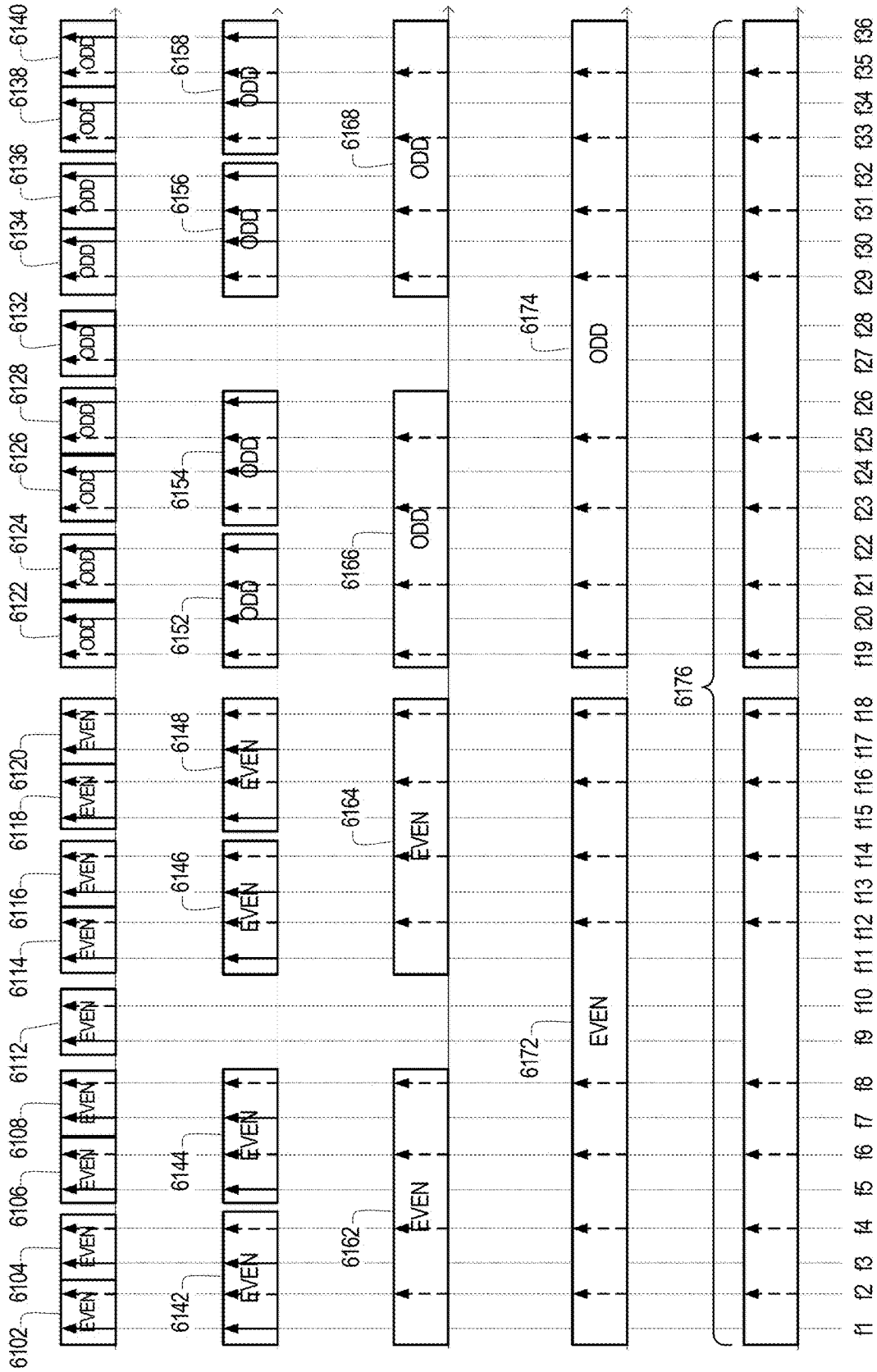

FIG. 62

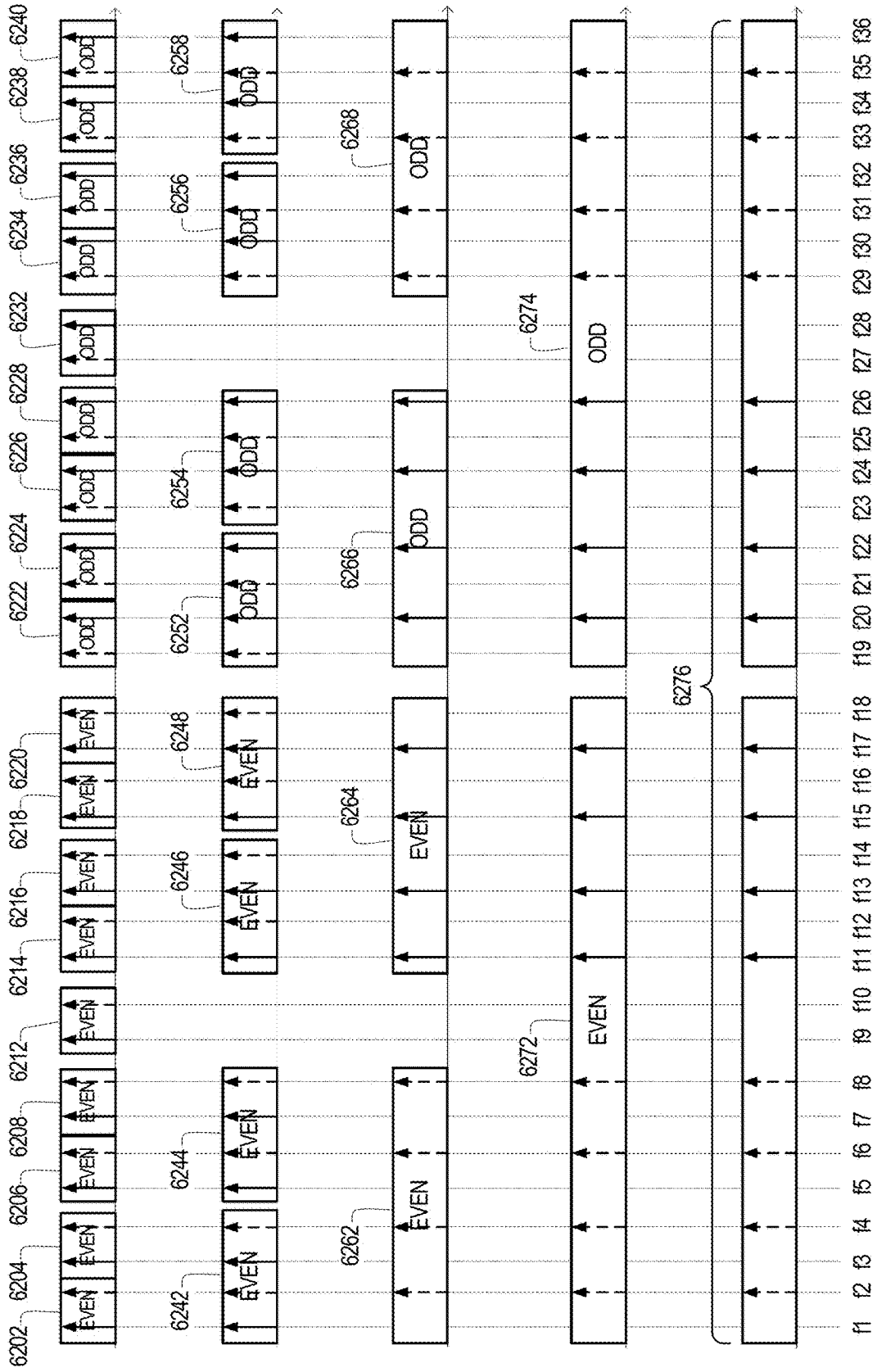

FIG. 63

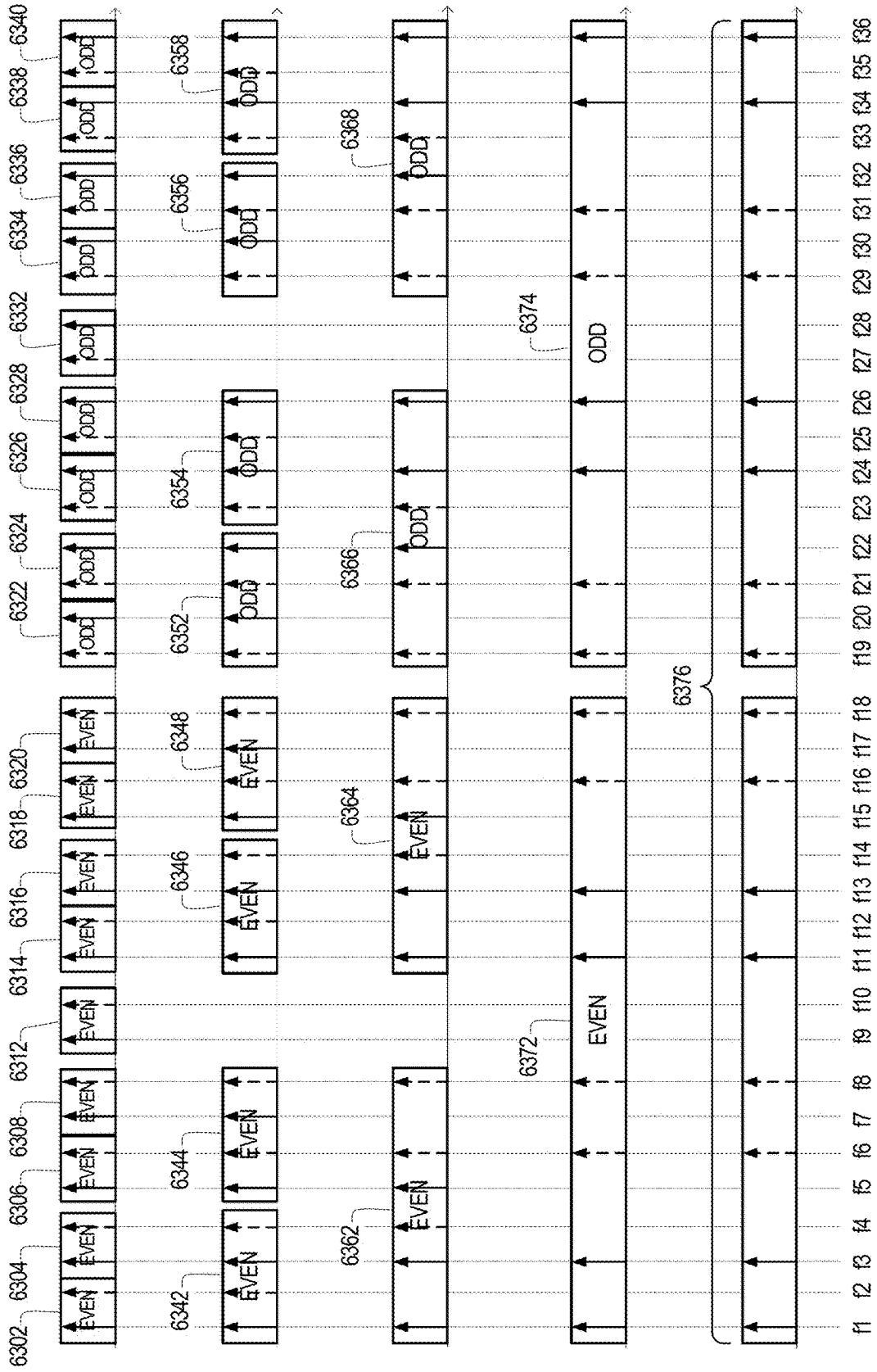

FIG. 64

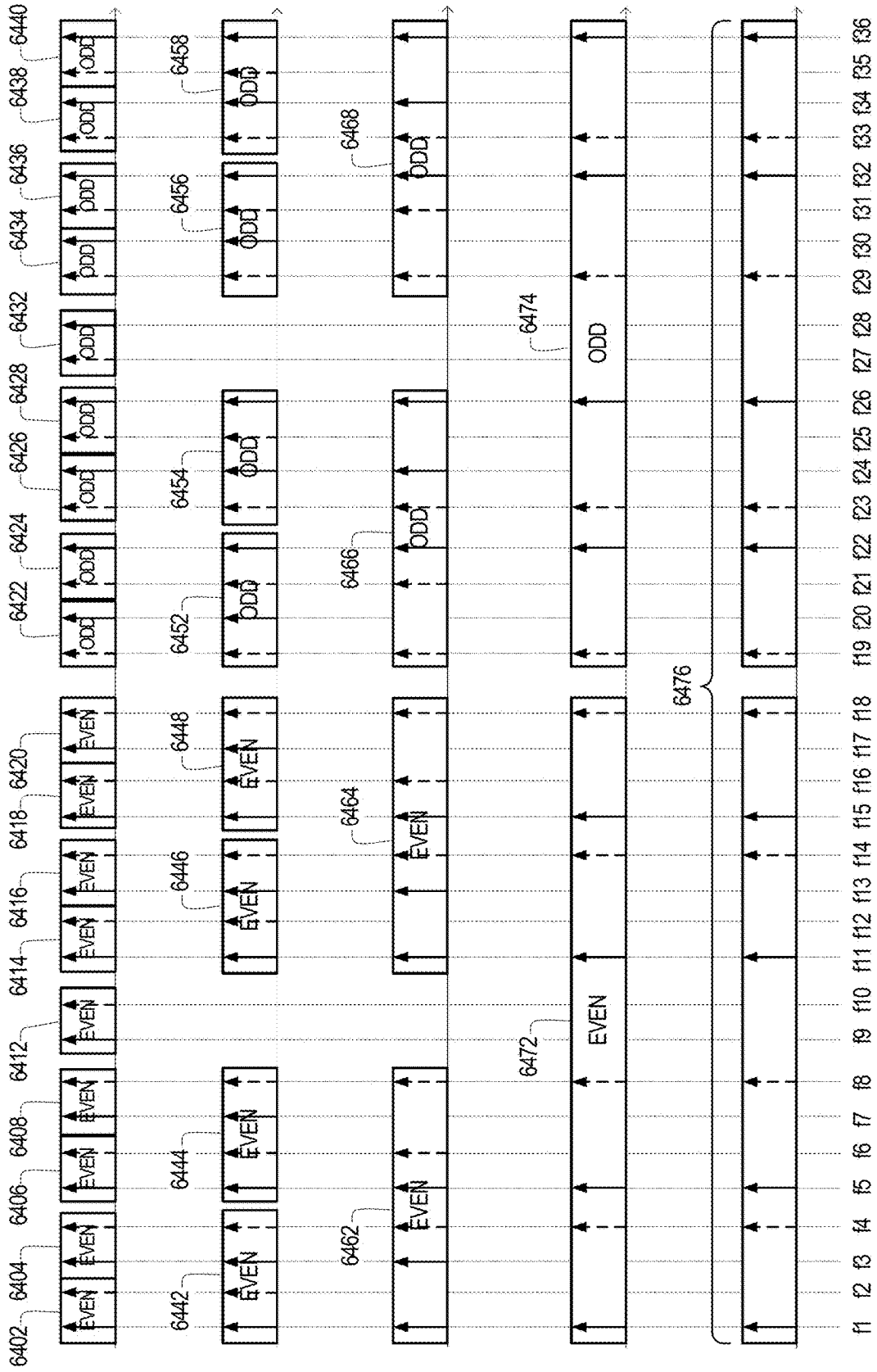

FIG. 65

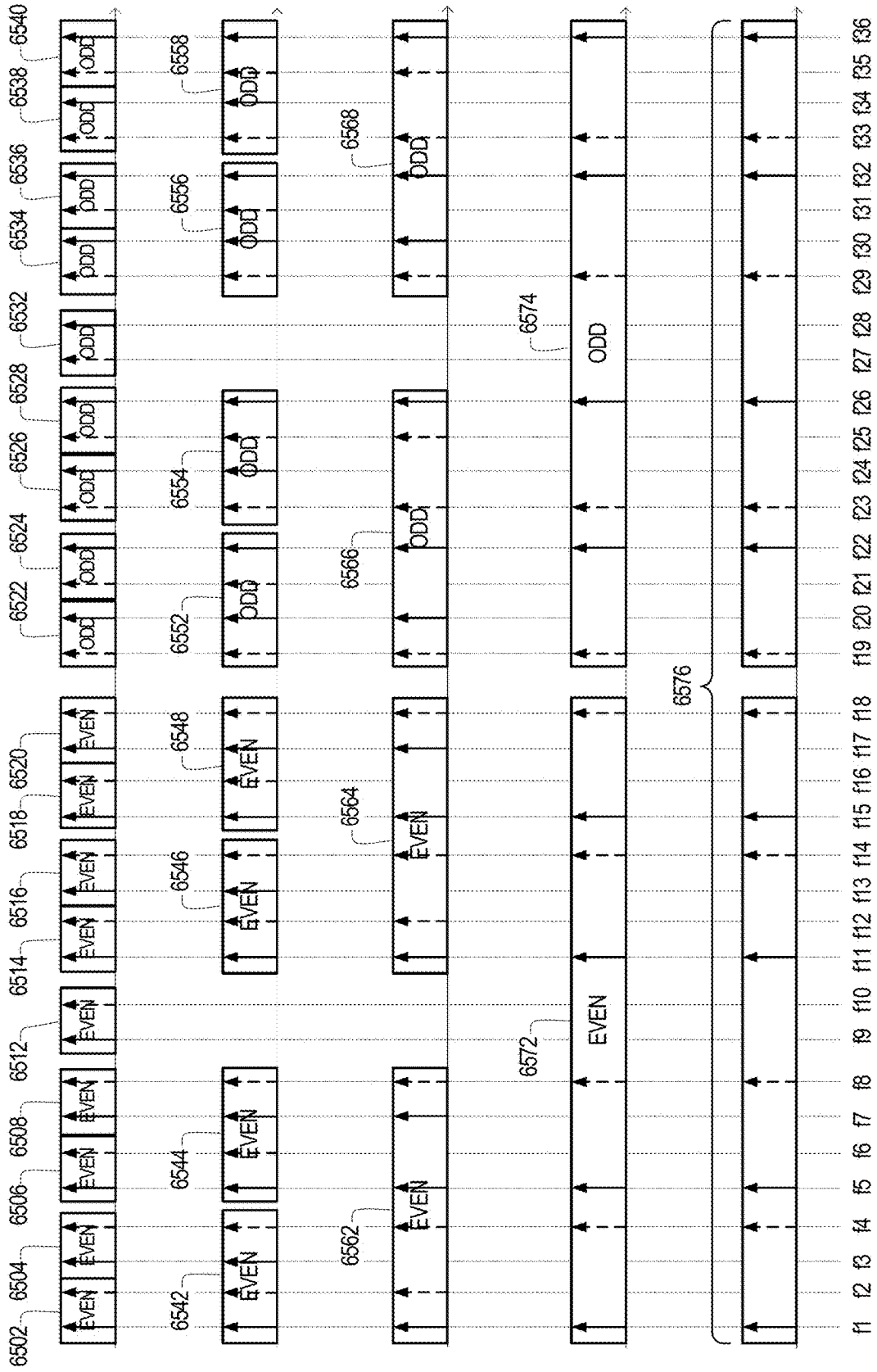

FIG. 66

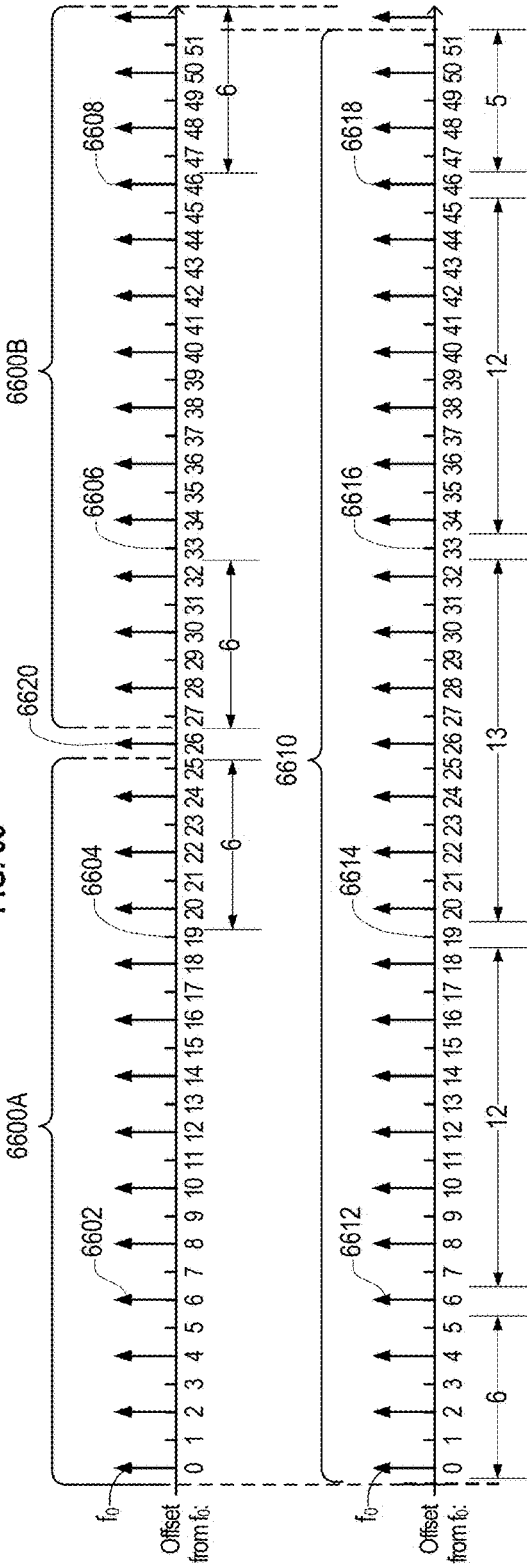

FIG. 67

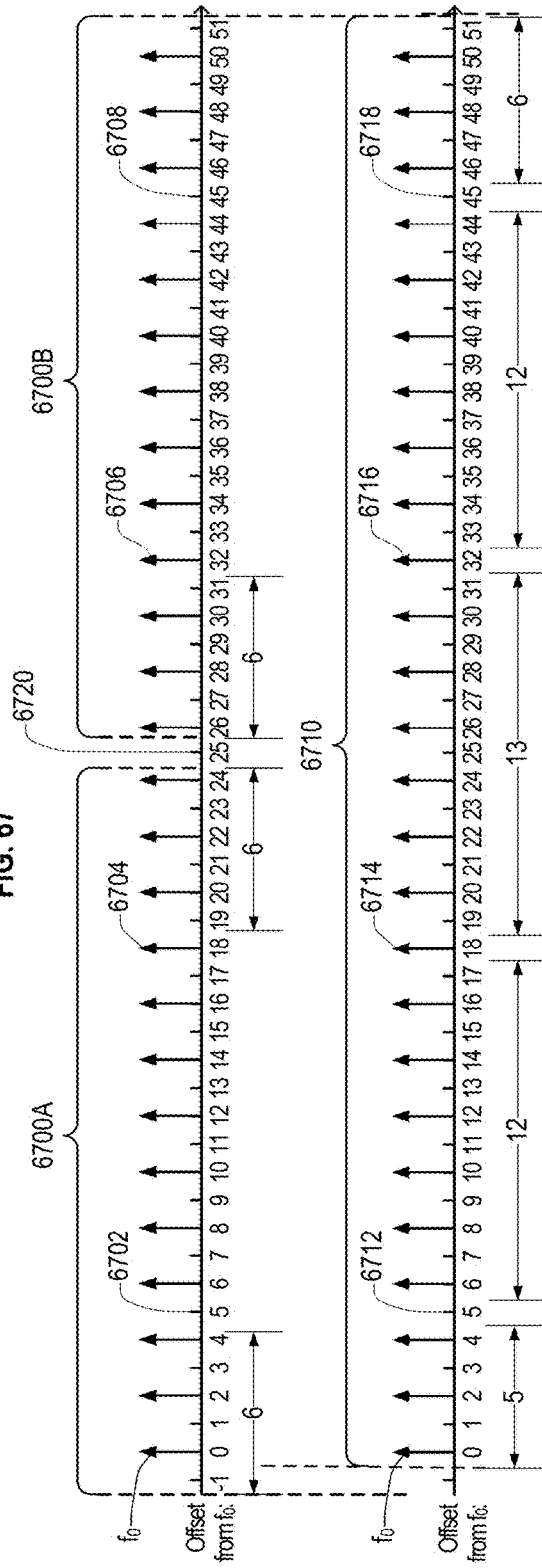

FIG. 68

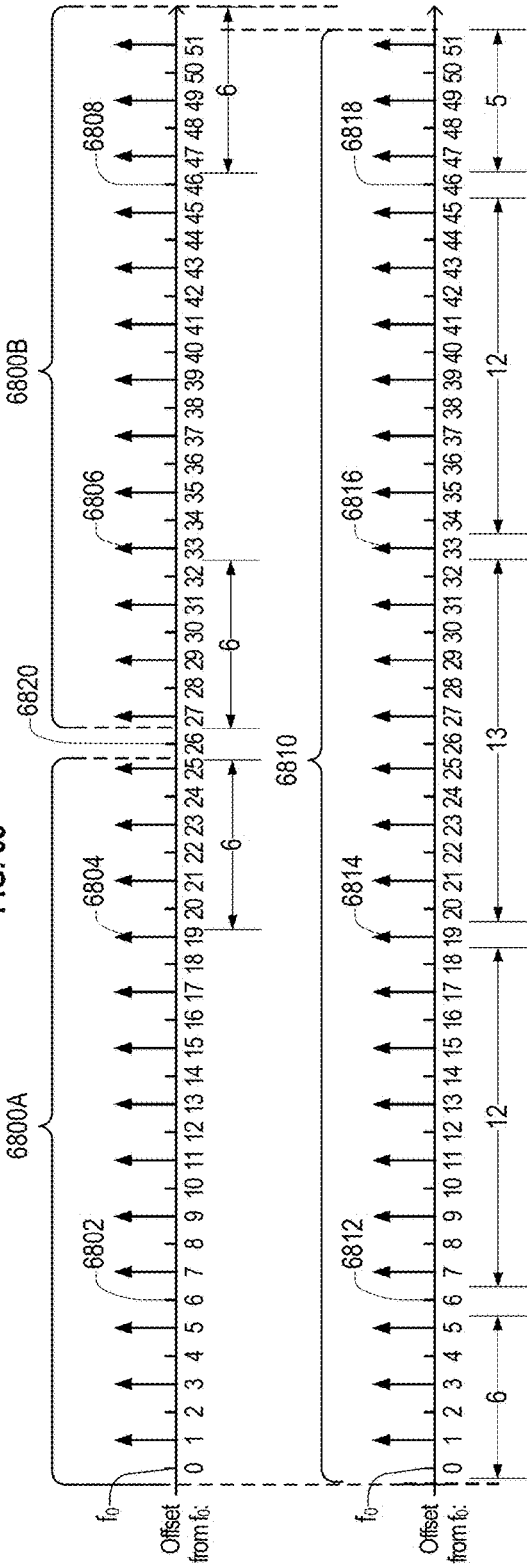

FIG. 69

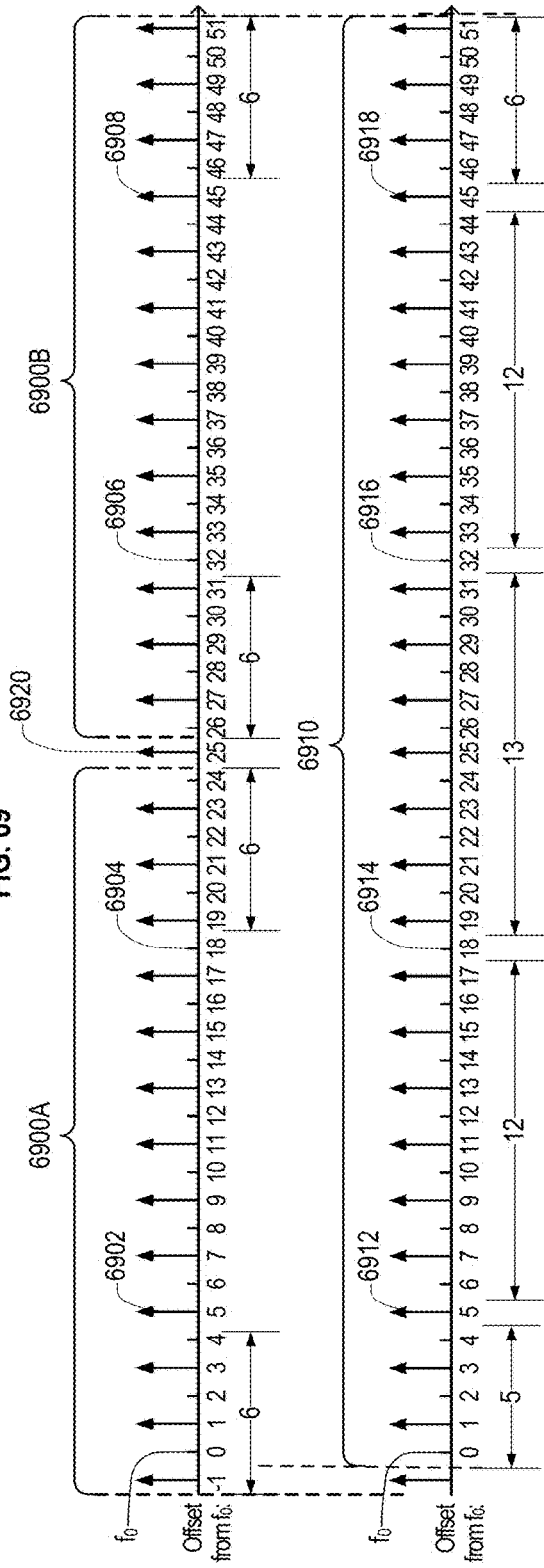

FIG. 70

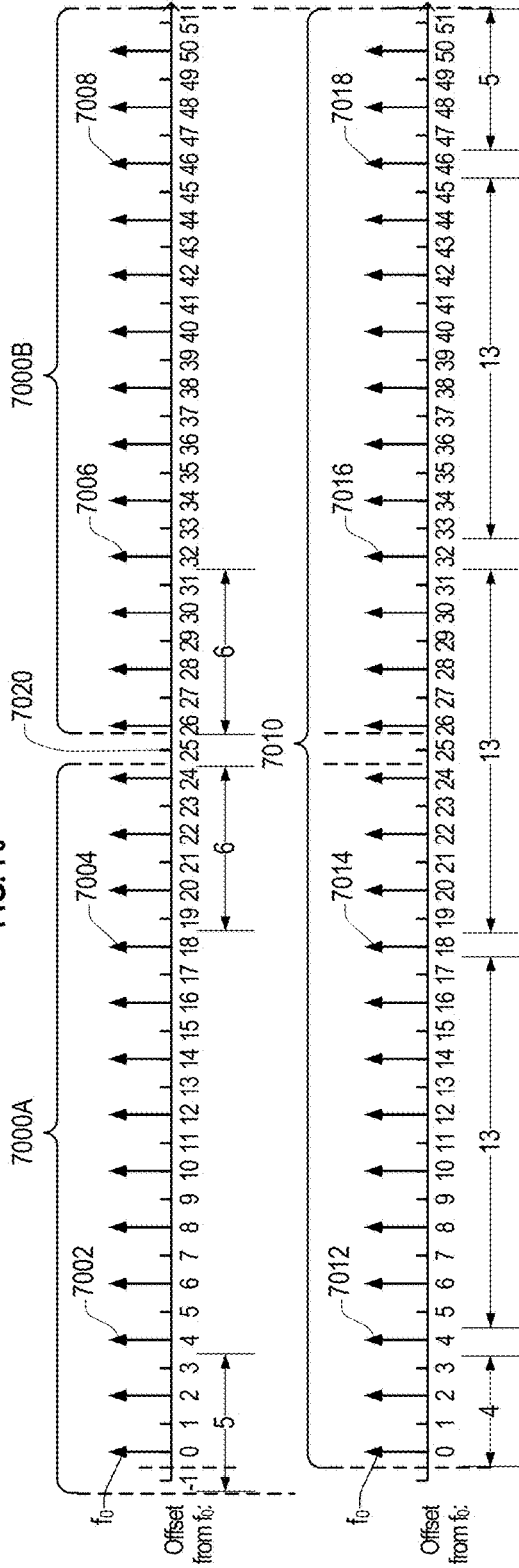

FIG. 71

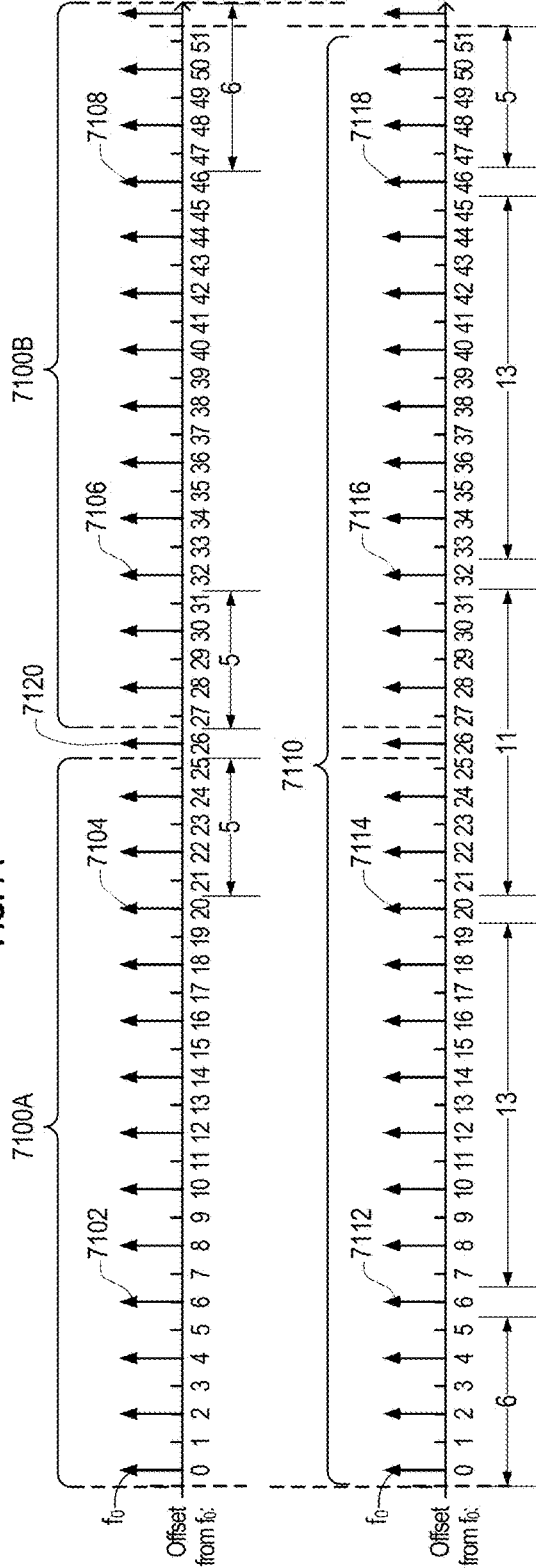

FIG. 72

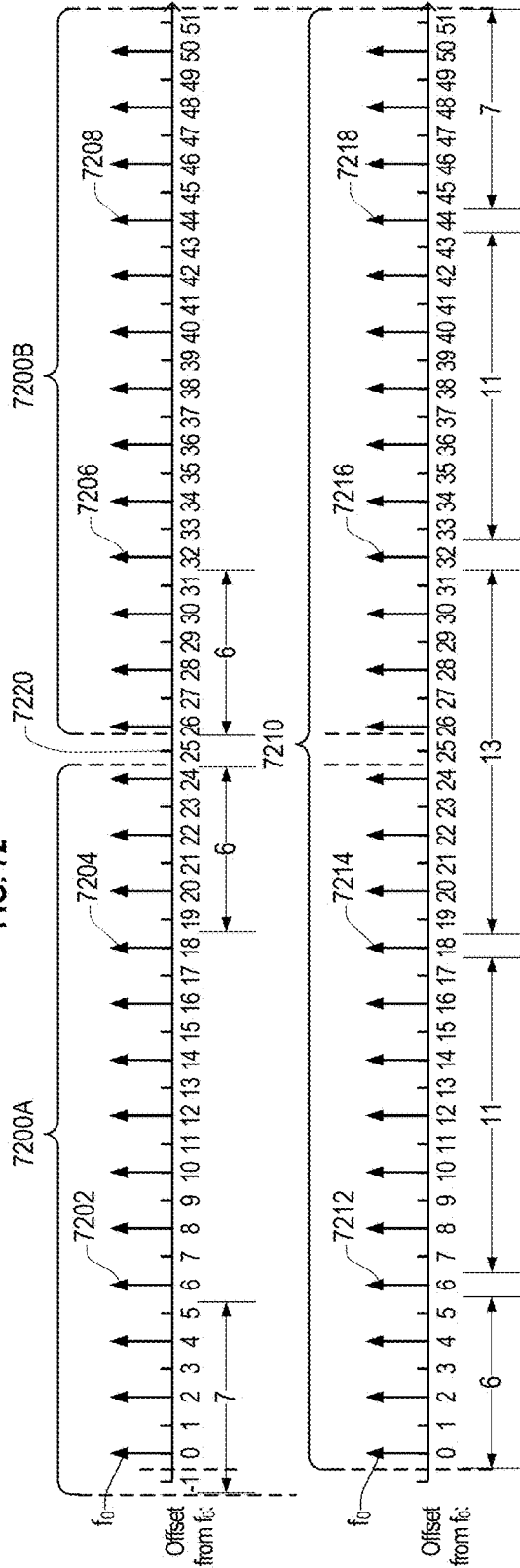
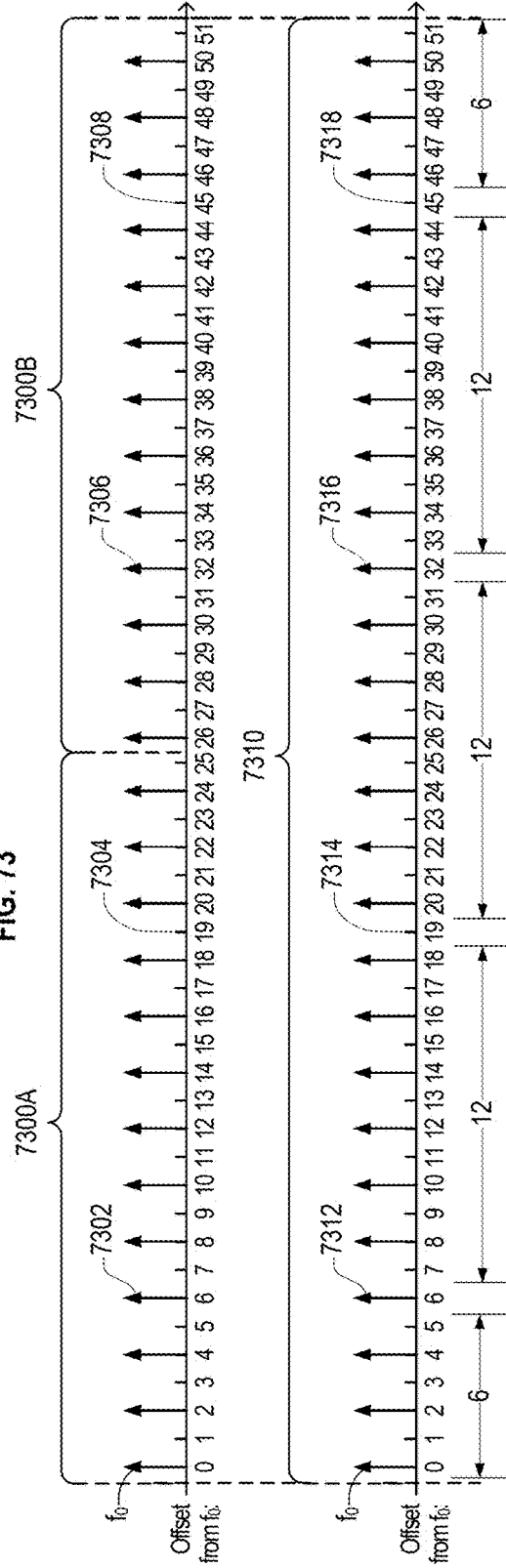

FIG. 73



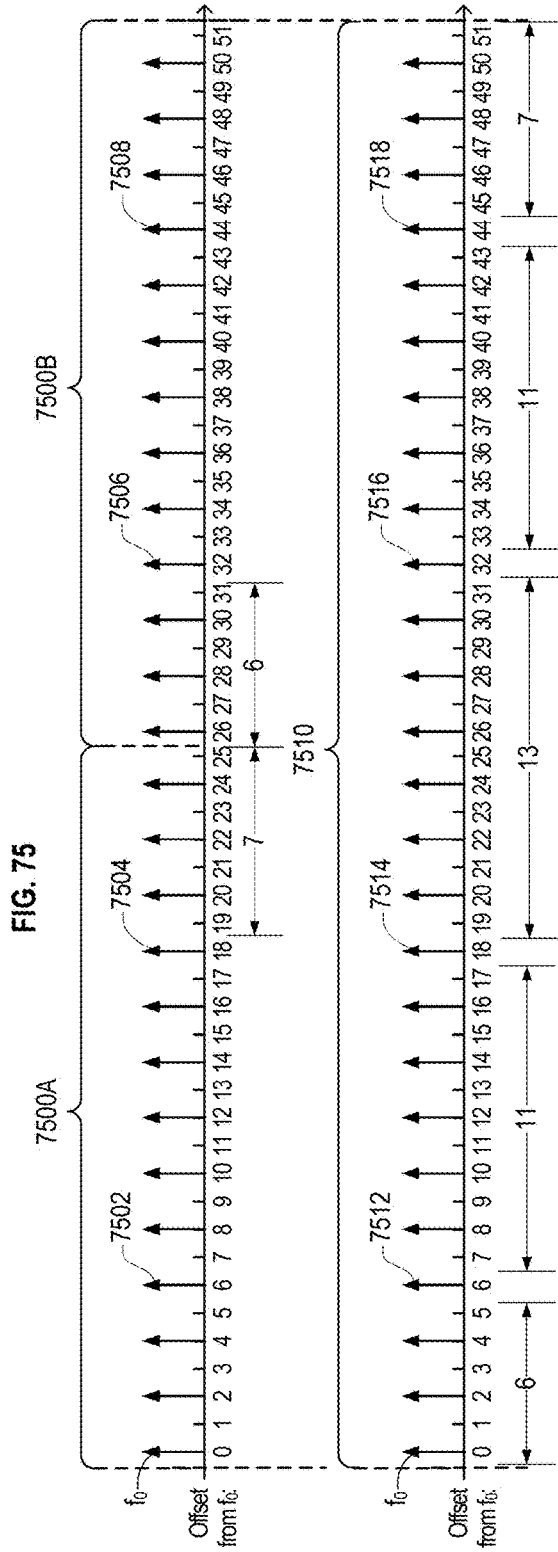
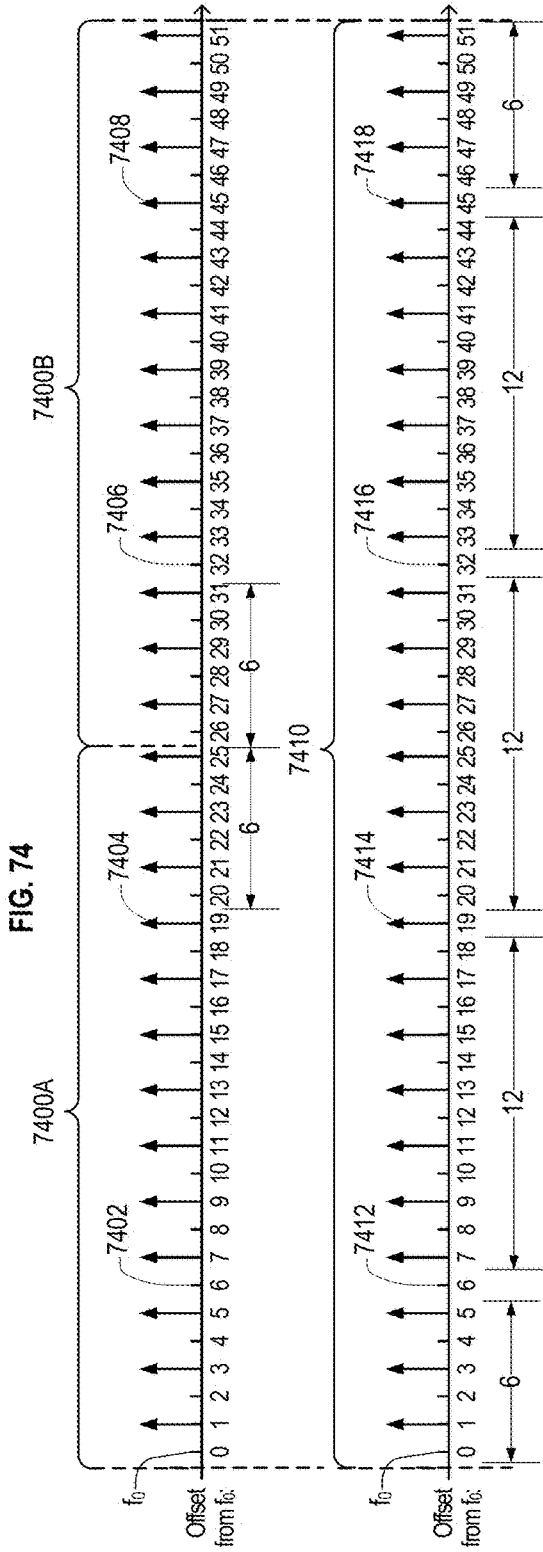

FIG. 76

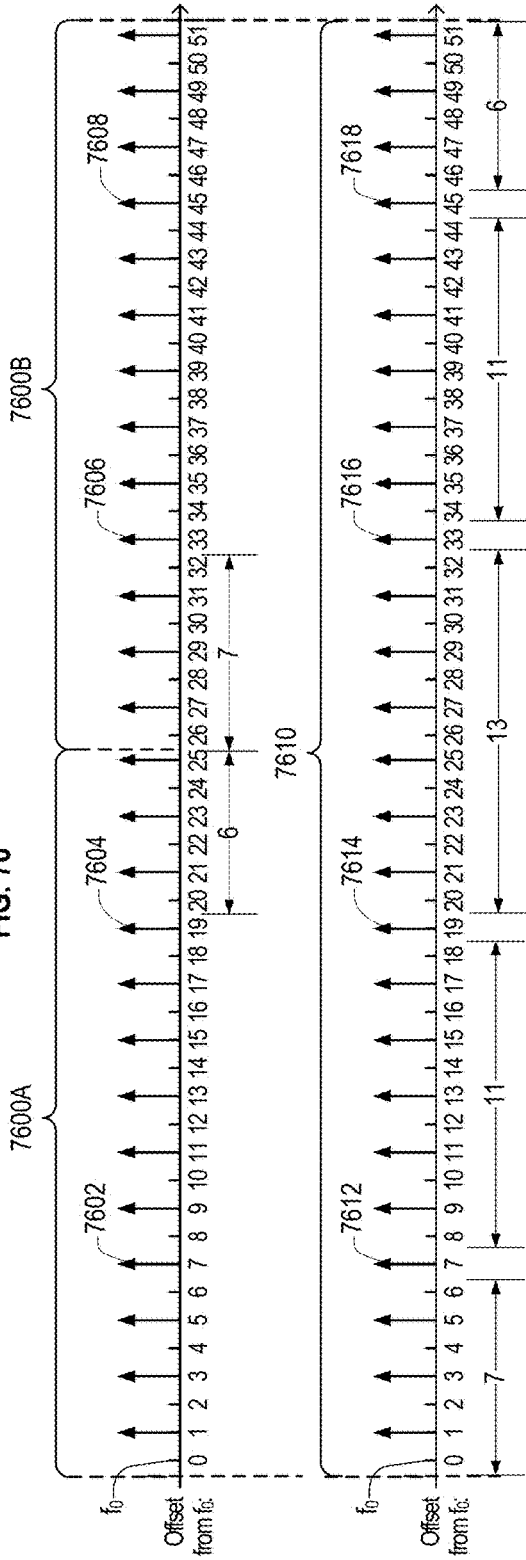

FIG. 77

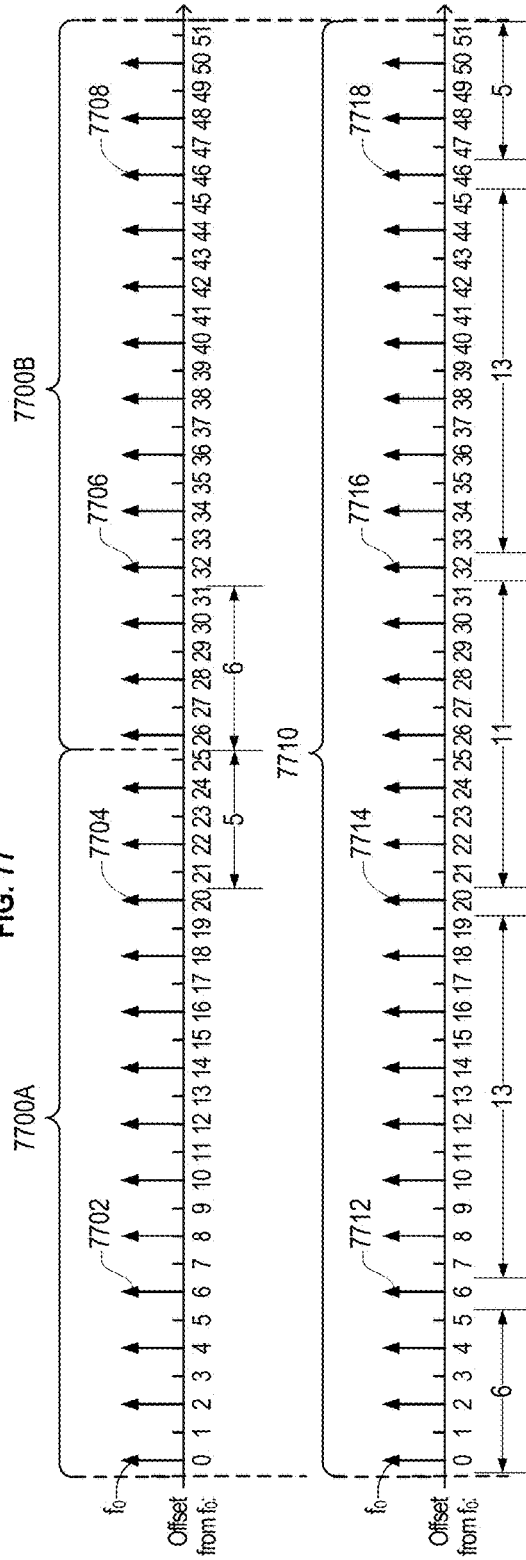

FIG. 78

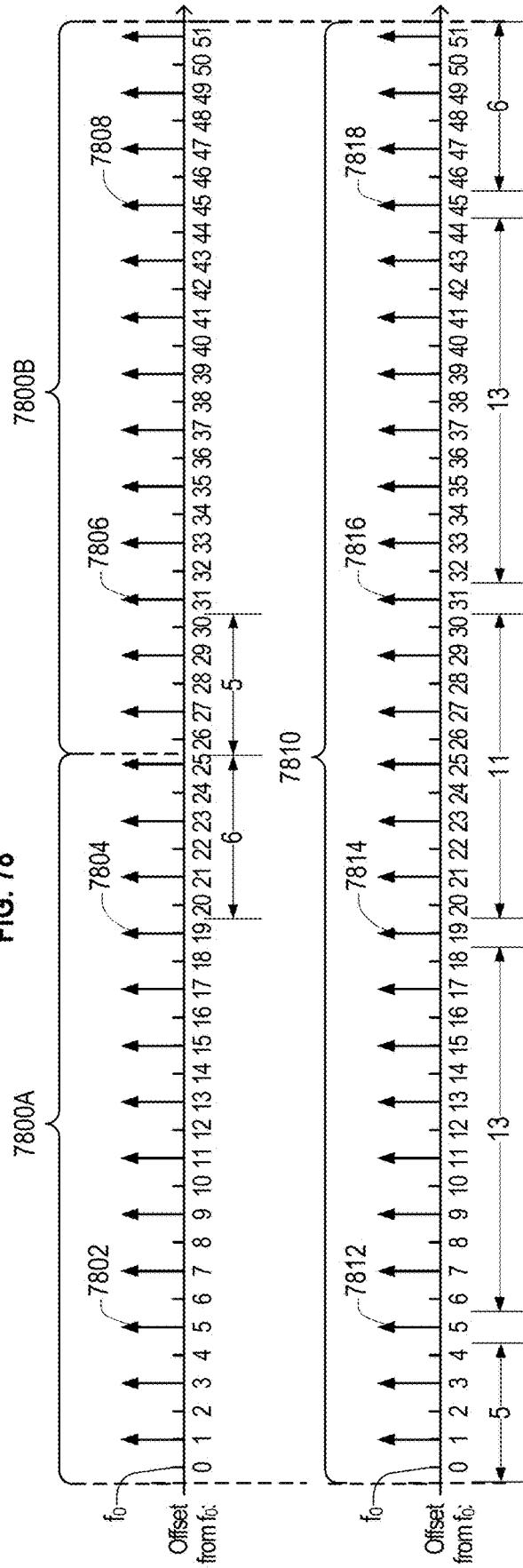

FIG. 79

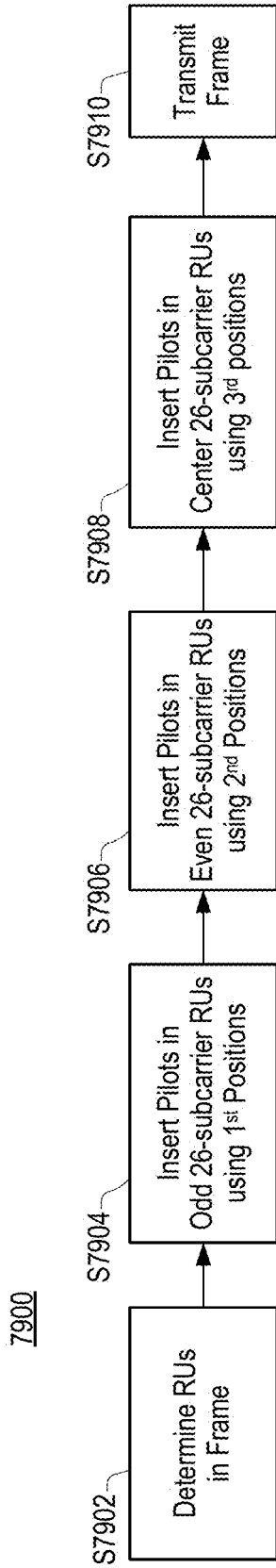

FIG. 80

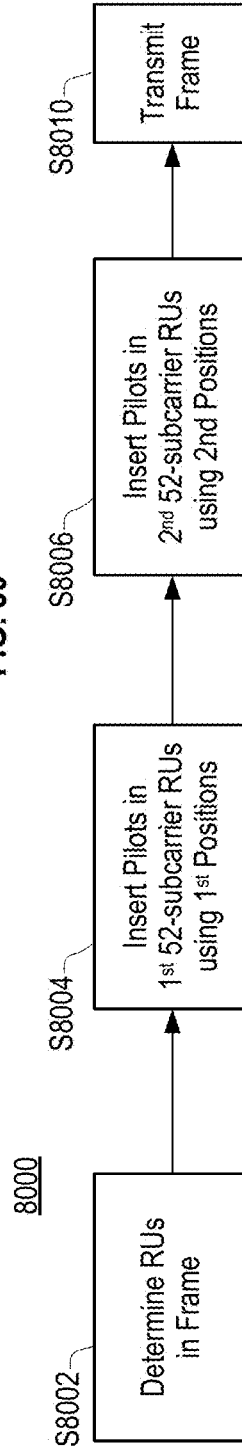

FIG. 81

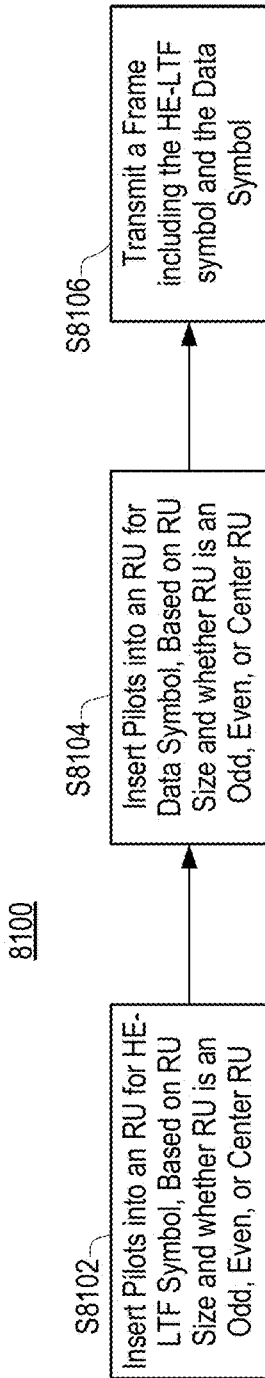
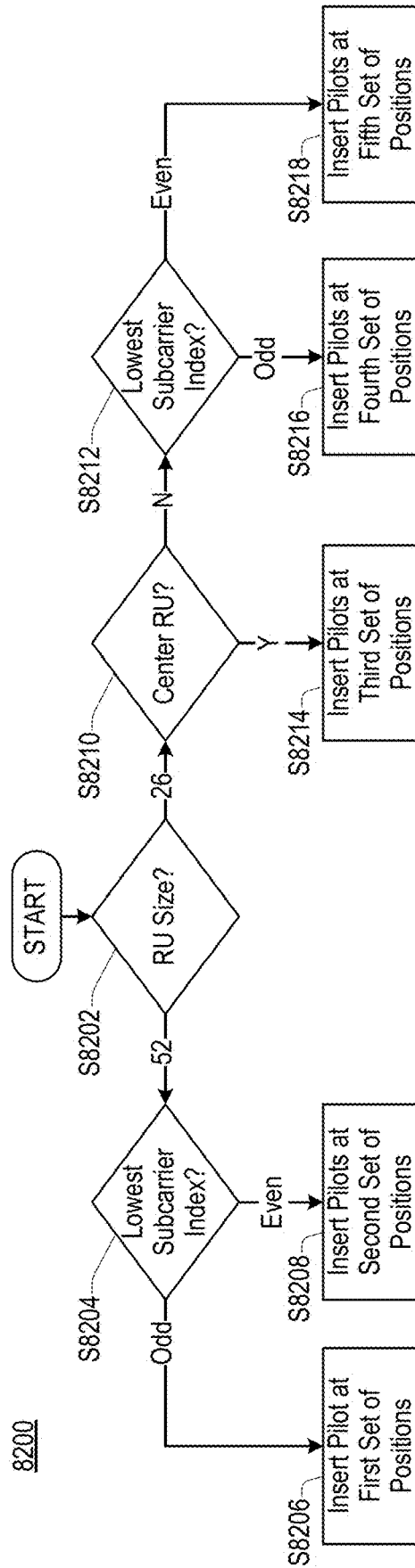
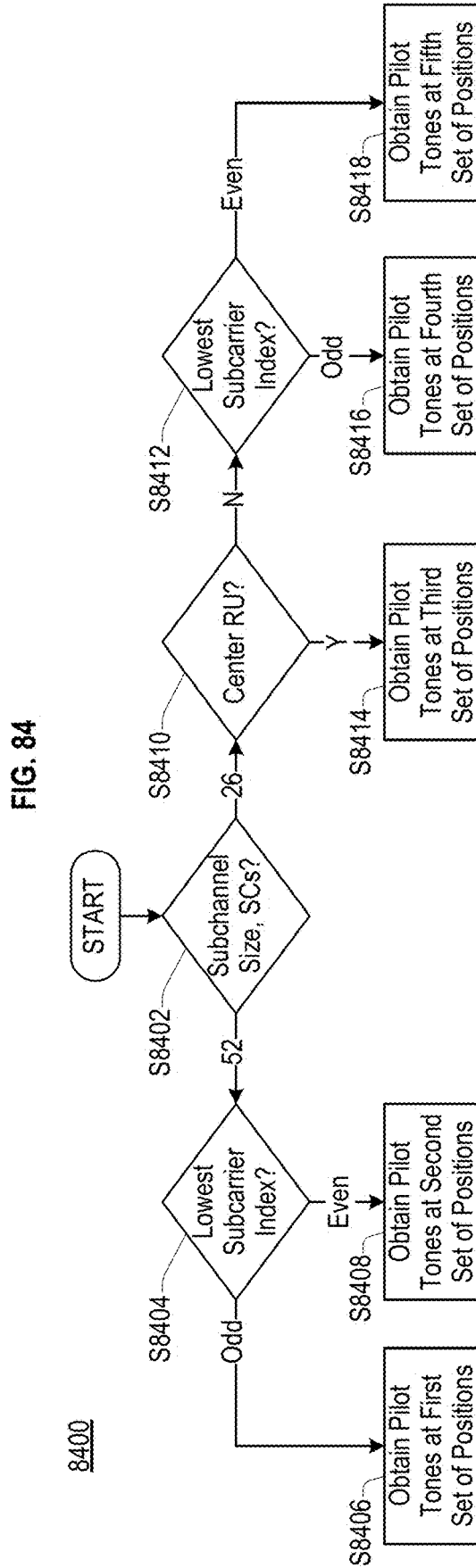
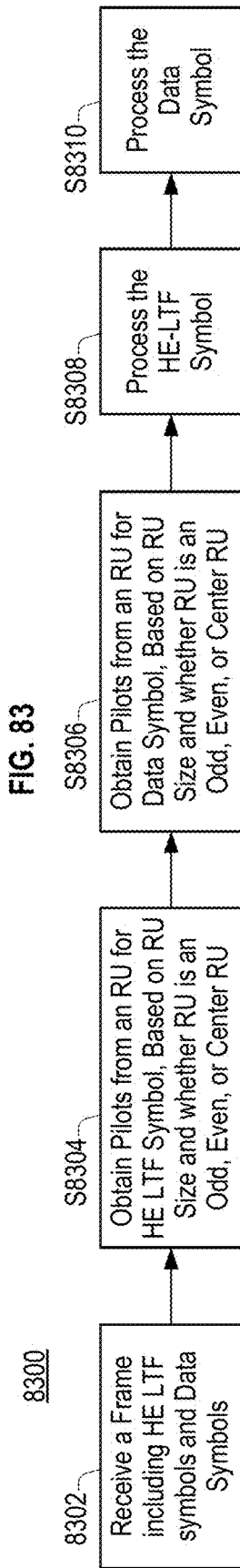

FIG. 82





**PILOT TRANSMISSION AND RECEPTION
FOR ORTHOGONAL FREQUENCY
DIVISION MULTIPLE ACCESS**

CROSS-REFERENCE TO RELATED
APPLICATION

[0001] This application is a continuation of application Ser. No. 17/882,403, filed on Aug. 5, 2022, now U.S. Pat. No. 11,652,594 issued May 16, 2023, which is a continuation of application Ser. No. 17/334,290, filed May 28, 2021, now U.S. Pat. No. 11,418,307 issued Aug. 16, 2022, which is a continuation of application Ser. No. 16/816,092, filed Mar. 11, 2020, now U.S. Pat. No. 11,050,539 issued Jun. 29, 2021, which is a continuation of application Ser. No. 16/443,683, filed Jun. 17, 2019, now U.S. Pat. No. 10,630,444 issued Apr. 21, 2020, which is a continuation of application Ser. No. 15/444,188, filed Feb. 27, 2017, now U.S. Pat. No. 10,361,828 issued Jul. 23, 2019, which is a continuation of application Ser. No. 15/150,127, filed May 9, 2016, now U.S. Pat. No. 9,621,311 issued Apr. 11, 2017, which claims the benefit of U.S. Provisional Application No. 62/159,187, filed May 8, 2015, the contents of which are incorporated herein by reference.

BACKGROUND

1. Technical Field

[0002] The technology described herein relates generally to wireless networking. More particularly, the technology relates to the transmission and reception of symbols (such as symbols in Orthogonal Frequency Division Multiple Access (OFDMA) frames) that include pilots transmitted using pilot tones.

2. Description of the Related Art

[0003] Wireless LAN (WLAN) devices are currently being deployed in diverse environments. Some of these environments have large numbers of access points (APs) and non-AP stations in geographically limited areas. In addition, WLAN devices are increasingly required to support a variety of applications such as video, cloud access, and offloading. In particular, video traffic is expected to be the dominant type of traffic in many high efficiency WLAN deployments. With the real-time requirements of some of these applications, WLAN users demand improved performance in delivering their applications, including improved power consumption for battery-operated devices.

[0004] A WLAN is being standardized by the IEEE (Institute of Electrical and Electronics Engineers) Part 11 under the name of “Wireless LAN Medium Access Control (MAC) and Physical Layer (PHY) Specifications.” A series of standards have been adopted as the WLAN evolved, including IEEE Std 802.11™-2012 (March 2012) (hereinafter, IEEE Std 802.11). The IEEE Std 802.11 was subsequently amended by IEEE Std 802.11ae™-2012, IEEE Std 802.11aa™-2012, IEEE Std 802.11ad™-2012, and IEEE Std 802.11ac™-2013 (hereinafter, IEEE 802.11ac).

[0005] Recently, an amendment focused on providing a high efficiency (HE) WLAN in high-density scenarios is being developed by the IEEE 802.11ax task group. The 802.11ax amendment focuses on improving metrics that reflect user experience, such as average per station throughput, the 5th percentile of per station throughput of a group

of stations, and area throughput. Improvements will be made to support environments such as wireless corporate offices, outdoor hotspots, dense residential apartments, and stadiums.

[0006] An HE WLAN supports Orthogonal Frequency Division Multiple Access (OFDMA) communications. In the OFDMA communications, an Access Point (AP) may communicate simultaneously with a plurality of stations by allocating respective Resource Units (RUs) (that is, groups of subchannels) within the stations.

[0007] An HE WLAN also supports the use of longer symbols in data fields of an HE frame. For example, while a preamble of the HE frame may include Orthogonal Frequency Division Multiplexing (OFDM) symbols have respective durations, exclusive of Cyclic Prefixes (CPs), of 3.2 microseconds, a data field of the HE frame may include OFDM symbols have respective durations, exclusive of CPs, of 12.8 microseconds.

[0008] A duration of an OFDM symbol may be determined according to a number of input elements of a Fourier Transform (FT) or Inverse Fourier Transform (iFT) respectively used to decode or generate the OFDM symbol. An OFDM symbol having a duration, exclusive of CP, of 3.2 microseconds in a 20 MHz bandwidth may be generated using an iFT having 64 input elements (i.e. a 64-element iFT) and decoded using a FT having 64 input elements (i.e. a 64-element FT). An OFDM symbol having a duration, exclusive of CP, of 12.8 microseconds in a 20 MHz bandwidth may be generated using an iFT having 256 input elements (i.e. a 256-element iFT) and decoded using a FT having 256 input elements (i.e. a 256-element FT). A number of input elements of an FT or iFT may be referred to as a size of the FT or iFT.

[0009] Pilots are used in 802.11 systems for performing channel estimation and for performing carrier frequency offset (CFO) tracking. Pilots used for channel estimation may be included in a training field, such as a Long Training Field (LTF).

[0010] CFO may occur, for example, because of a frequency mismatch between oscillators of a transmitter and a receiver or because of the Doppler Effect due to relative motions of the transmitter and receiver. Even if the channel state does not change over a duration of a received frame, a residual CFO may changeover the duration. Because the CFO may change during the duration, pilots for CFO tracking may be included in symbols of data fields. Such pilots may be carried by pilot tones located at pilot tone positions of the symbols.

[0011] Ideally, pilots are included in all OFDM symbols, and span the entire frequency bandwidth of the transmitted signal so that CFO tracking performance may be improved by the inclusion of frequency diversity. The positioning of pilots tones carrying the pilots may vary between symbols in training fields and symbols in data fields, and between symbols generated using different Fourier Transform (FT) sizes.

SUMMARY

[0012] In an embodiment, a method of a wireless device for transmitting a frame comprises determining, by the wireless device, a plurality of Resource Units (RUs) of the frame, providing a first plurality of pilots into a first RU of the frame at a first set of positions, respectively, providing a second plurality of pilots into a second RU of the frame at

a second set of positions, respectively, and transmitting the frame. The first set of positions is different from the second set of positions.

[0013] In an embodiment, the frame is an Orthogonal Frequency Division Multiple Access (OFDMA) frame and the plurality of RUs include respective pluralities of subcarriers.

[0014] In an embodiment, the first RU includes a lowest subcarrier having an odd-numbered index, and the second RU includes a lowest subcarrier having an even-numbered index.

[0015] In an embodiment, the first RU is a 52-subcarrier RU and the second RUs is a 52-subcarrier RU.

[0016] In an embodiment, the first set of positions include a first pilot tone position spaced five subcarriers away from a lowest-indexed subcarrier of the first RU, a second pilot tone position separated by thirteen subcarriers from the first pilot tone position, a third pilot tone position separated by eleven subcarriers from the second pilot tone position, and a fourth pilot tone position separated by thirteen subcarriers from the third pilot tone position and six subcarriers away from a highest-indexed subcarrier of the first RU. The pilot tones of the second RU include a fifth pilot tone position spaced six subcarriers away from a lowest-indexed subcarrier of the first RU, a sixth pilot tone position separated by thirteen subcarriers from the fifth pilot tone position, a seventh pilot tone position separated by eleven subcarriers from the sixth pilot tone position, and an eighth pilot tone position separated by thirteen subcarriers from the seventh pilot tone position and five subcarriers away from a highest-indexed subcarrier of the second RU.

[0017] In an embodiment, the first RU is a 26-subcarrier RU, and the second RU is a 26-subcarrier RU.

[0018] In an embodiment, the first set of positions include a first pilot tone position spaced five subcarriers away from a lowest-indexed subcarrier of the first RU and a second pilot tone position separated by thirteen subcarriers from the first pilot tone position and spaced six subcarriers away from a highest-indexed subcarrier of the first RU. The second set of positions includes a third pilot tone position spaced six subcarriers away from a lowest-indexed subcarrier of the second RU and a fourth pilot tone position separated by thirteen subcarriers from the third pilot tone position and five subcarriers away from a highest-indexed subcarrier of the second RU.

[0019] In an embodiment, the method further comprises providing a third plurality of pilots in a third RU of the frame at a third set of positions, respectively. The second set of positions is different from the third set of positions, the third RU is a 26-subcarrier RU, and the third RU is a center RU that is split into 13 positive-indexed subcarriers and 13 negative-indexed subcarriers by DC tones.

[0020] In an embodiment, the third set of positions includes a fifth pilot tone position spaced six subcarriers away from a lowest-indexed subcarrier of the third RU and a sixth pilot tone position spaced six subcarriers away from a highest-indexed subcarrier of the third RU

[0021] In an embodiment, the first set of positions is a mirror image of the second set of positions.

[0022] In an embodiment, the frame includes a 2× High Efficiency (HE) Long Training Field (HE-LTF). The first set of positions respectively correspond to locations of non-null subcarriers of symbols of the 2×HE-LTE. The second set of

positions respectively correspond to the locations of the non-null subcarriers of the symbols of the 2×HE-LTF.

[0023] In an embodiment, pilot tone positions for all RUs in a lower half of a 20 MHz channel are mirror symmetric to pilot tone positions for corresponding mirrored RUs in an upper half of the 20 MHz channel.

[0024] In an embodiment, pilot tone positions for all RUs in a lower half of a 40 MHz channel are mirror symmetric to pilot tone positions for corresponding mirrored RUs in an upper half of the 40 MHz channel.

[0025] In an embodiment, a method of a wireless device for transmitting a frame comprises providing pilots in a resource unit, and transmitting the frame including the resource unit. When a lowest subcarrier of the resource unit has an odd-numbered index, a plurality of pilots are included at a first set of positions in the resource unit, respectively. When the a lowest subcarrier of the resource unit has an even-numbered index, a plurality of pilots are included at a second set of positions in the resource unit, respectively. The second set of positions is different from the first set of positions.

[0026] In an embodiment, the resource unit is a 52-subcarrier resource unit.

[0027] In an embodiment, the first set of positions include a first pilot tone position spaced five subcarriers away from a lowest-indexed subcarrier of the resource unit, a second pilot tone position separated by thirteen subcarriers from the first pilot tone position, a third pilot tone position separated by eleven subcarriers from the second pilot tone position, and a fourth pilot tone position separated by thirteen subcarriers from the third pilot tone position and six subcarriers away from a highest-indexed subcarrier of the resource unit. The second set of positions include a fifth pilot tone position spaced six subcarriers away from a lowest-indexed subcarrier of the resource unit, a sixth pilot tone position separated by thirteen subcarriers from the fifth pilot tone position, a seventh pilot tone position separated by eleven subcarriers from the sixth pilot tone position, and an eighth pilot tone position separated by thirteen subcarriers from the seventh pilot tone position and five subcarriers away from a highest-indexed subcarrier of the resource unit.

[0028] In an embodiment, the resource unit is a 26-subcarrier resource unit.

[0029] In an embodiment, the first set of positions include a first pilot tone position spaced five subcarriers away from a lowest-indexed subcarrier of the resource unit and a second pilot tone position separated by thirteen subcarriers from the first pilot tone position and six subcarriers away from a highest-indexed subcarrier of the resource unit. The second set of positions include includes a third pilot tone position spaced six subcarriers away from a lowest-indexed subcarrier of the resource unit and a fourth pilot tone position separated by thirteen subcarriers from the third pilot tone position and five subcarriers away from a highest-indexed subcarrier of the resource unit.

[0030] In an embodiment, when the resource unit is a center resource unit that is split into 13 negative-indexed subcarriers and 13 positive-indexed subcarriers by DC tones, a plurality of pilots are included at a third set of positions in the resource unit, respectively. The third set of positions is different from the second set of positions.

[0031] In an embodiment, the first set of positions include a first pilot tone position spaced five subcarriers away from a lowest-indexed subcarrier of the resource unit and a

second pilot tone position separated by thirteen subcarriers from the first pilot tone position and six subcarriers away from a highest-indexed subcarrier of the resource unit. The second set of positions includes a third pilot tone position spaced six subcarriers away from a lowest-indexed subcarrier of the resource unit and a fourth pilot tone position separated by thirteen subcarriers from the third pilot tone position and five subcarriers away from a highest-indexed subcarrier of the resource unit. The third set of positions includes a fifth pilot tone position spaced six subcarriers away from a lowest-indexed subcarrier of the resource unit and a sixth pilot tone position spaced six subcarriers away from a highest-indexed subcarrier of the resource unit.

[0032] In an embodiment, a method of a wireless device for receiving a frame comprises receiving the frame. The frame includes a resource unit. The resource unit includes pilots. The method further comprises processing the pilots. When a lowest subcarrier of the resource unit has an odd-numbered index, a plurality of pilots are included at a first set of positions in the resource unit, respectively. When the lowest subcarrier of the resource unit has an even-numbered index, a plurality of pilots are included at a second set of positions in the resource unit, respectively. The second set of positions is different from the first set of positions.

[0033] In an embodiment, the resource unit is a 52-subcarrier resource unit.

[0034] In an embodiment, the first set of positions include a first pilot tone position spaced five subcarriers away from a lowest-indexed subcarrier of the resource unit, a second pilot tone position separated by thirteen subcarriers from the first pilot tone position, a third pilot tone position separated by eleven subcarriers from the second pilot tone position, and a fourth pilot tone position separated by thirteen subcarriers from the third pilot tone position and six subcarriers away from a highest-indexed subcarrier of the resource unit. The second set of positions include a fifth pilot tone position spaced six subcarriers away from a lowest-indexed subcarrier of the resource unit, a sixth pilot tone position separated by thirteen subcarriers from the fifth pilot tone position, a seventh pilot tone position separated by eleven subcarriers from the sixth pilot tone position, and an eighth pilot tone position separated by thirteen subcarriers from the seventh pilot tone position and spaced five subcarriers away from a highest-indexed subcarrier of the resource unit.

[0035] In an embodiment, the resource unit is a 26-subcarrier resource unit.

[0036] In an embodiment, the first set of positions include a first pilot tone position spaced five subcarriers away from a lowest-indexed subcarrier of the resource unit and a second pilot tone position separated by thirteen subcarriers from the first pilot tone position and spaced six subcarriers away from a highest-indexed subcarrier of the resource unit. The second set of positions includes a third pilot tone position spaced six subcarriers away from a lowest-indexed subcarrier of the resource unit and a fourth pilot tone position separated by thirteen subcarriers from the third pilot tone position and spaced five subcarriers away from a highest-indexed subcarrier of the resource unit.

[0037] In an embodiment, when the resource unit is a center resource unit that is split into 13 negative-indexed subcarriers and 13 positive-indexed subcarriers by DC tones, a plurality of pilots are included at a third set of positions in the resource unit, respectively. The third set of positions is different from the second set of positions.

[0038] In an embodiment, the first set of positions include a first pilot tone position spaced five subcarriers away from a lowest-indexed subcarrier of the resource unit and a second pilot tone position separated by thirteen subcarriers from the first pilot tone position and spaced six subcarriers away from a highest-indexed subcarrier of the resource unit. The second set of positions includes a third pilot tone position spaced six subcarriers away from a lowest-indexed subcarrier of the resource unit and a fourth pilot tone position separated by thirteen subcarriers from the third pilot tone position and spaced five subcarriers away from a highest-indexed subcarrier of the resource unit. The third set of positions includes a fifth pilot tone position spaced six subcarriers away from a lowest-indexed subcarrier of the resource unit and a sixth pilot tone position spaced six subcarriers away from a highest-indexed subcarrier of the resource unit.

BRIEF DESCRIPTION OF THE DRAWINGS

[0039] FIG. 1 illustrates a wireless network according to an embodiment.

[0040] FIG. 2 is a schematic diagram of a wireless device according to an embodiment.

[0041] FIG. 3A illustrates components of a wireless device configured to transmit data according to an embodiment.

[0042] FIG. 3B illustrates components of a wireless device configured to receive data according to an embodiment.

[0043] FIG. 4A illustrates an Orthogonal Frequency Division Multiple Access (OFDMA) frame including a High Efficiency (HE) Long Training Field (LTF) according to an embodiment.

[0044] FIG. 4B illustrates positions in an even-aligned Resource Unit (RU) of tones corresponding to tones of a $2 \times \text{LTF}$ having an even mapping, according to an embodiment.

[0045] FIG. 4C illustrates positions in an even-aligned RU of tones corresponding to tones of the $2 \times \text{LTF}$ having an odd mapping, according to an embodiment.

[0046] FIG. 4D illustrates positions in an RU of tones corresponding to tones of the $4 \times \text{LTF}$ according to an embodiment.

[0047] FIG. 5A illustrates even and odd RUs in a 20 MHz bandwidth according to an embodiment.

[0048] FIG. 5B is a table listing subcarrier indexes of the RUs of FIG. 5.

[0049] FIG. 6 illustrates even and odd RUs in a 40 MHz bandwidth according to an embodiment.

[0050] FIG. 7 illustrates even and odd RUs in an 80 MHz bandwidth according to an embodiment.

[0051] FIG. 8A illustrates even and odd RUs in a 20 MHz bandwidth according to another embodiment.

[0052] FIG. 8B is a table listing subcarrier indexes of the RUs of FIG. 8.

[0053] FIG. 9 illustrates even and odd RUs in a 40 MHz bandwidth according to another embodiment.

[0054] FIG. 10 illustrates an RU according to an embodiment.

[0055] FIG. 11 illustrates an RU having mirror symmetry to the RU of FIG. 10, according to an embodiment.

[0056] FIG. 12 illustrates a 26-subcarrier RU of alternative 1 of design A, according to an embodiment.

[0057] FIG. 13 illustrates a 26-subcarrier RU of alternative 1 of design A, according to an embodiment.

[0115] FIG. 67 illustrates another option for pilot tone positions in Case 1, according to embodiments.

[0116] FIG. 68 illustrates another option for pilot tone positions in Case 1, according to embodiments.

[0117] FIG. 69 illustrates another option for pilot tone positions in Case 1, according to embodiments.

[0118] FIG. 70 illustrates another option for pilot tone positions in Case 1, according to embodiments.

[0119] FIG. 71 illustrates another option for pilot tone positions in Case 1, according to embodiments.

[0120] FIG. 72 illustrates another option for pilot tone positions in Case 1, according to embodiments.

[0121] FIG. 73 illustrates an option for pilot tone positions in Case 2, according to embodiments.

[0122] FIG. 74 illustrates another option for pilot tone positions in Case 2, according to embodiments.

[0123] FIG. 75 illustrates another option for pilot tone positions in Case 2, according to embodiments.

[0124] FIG. 76 illustrates another option for pilot tone positions in Case 2, according to embodiments.

[0125] FIG. 77 illustrates another option for pilot tone positions in Case 2, according to embodiments.

[0126] FIG. 78 illustrates another option for pilot tone positions in Case 2, according to embodiments.

[0127] FIG. 79 illustrates a process for transmitting a frame in a wireless network, according to an embodiment.

[0128] FIG. 80 illustrates another process for transmitting a frame in a wireless network, according to an embodiment.

[0129] FIG. 81 illustrates a process for transmitting a frame, according to an embodiment.

[0130] FIG. 82 illustrates a sub-process for providing pilots, according to an embodiment.

[0131] FIG. 83 illustrates a process for receiving a frame, according to an embodiment.

[0132] FIG. 84 illustrates a sub-process for obtaining pilots, according to an embodiment.

DETAILED DESCRIPTION

[0133] Embodiments of the present disclosure relate generally to wireless networking, and more particularly, to providing and processing pilots in Orthogonal Frequency Division Multiplexing (OFDM) symbols to support same and different FFT size for symbols in a Long Training Field (LTF) and OFDM symbols in a data field of a frame, the frame being a frame transmitted in a wireless network.

[0134] In the following detailed description, certain illustrative embodiments have been illustrated and described. As those skilled in the art would realize, these embodiments may be modified in various different ways without departing from the scope of the present disclosure. Accordingly, the drawings and description are to be regarded as illustrative in nature and not restrictive. Like reference numerals designate like elements in the specification.

[0135] FIG. 1 illustrates a wireless network according to an embodiment. The wireless network includes an infrastructure Basic Service Set (BSS) 100 of a Wireless Local Area Network (WLAN). In an 802.11 wireless LAN, the BSS provides the basic building-block and typically includes an access point (AP) and one or more associated stations (STAs). In FIG. 1, the BSS 100 includes an Access Point 102 (also referred to as AP) wirelessly communicating with first, second, third, and fourth wireless devices (or stations) 104, 106, 108, and 110 (also referred to as STA1, STA2, STA3, and STA4, respectively). The wireless devices

may each include a medium access control layer (MAC) and a physical layer (PHY) according to an IEEE 802.11 standard.

[0136] Although the example of FIG. 1 shows only the BSS 100 including only the first to fourth stations STA1 to STA4, embodiments are not limited thereto and may comprise BSSs including any number of STAs.

[0137] The AP 102 is a station, that is, a STA, configured to control and coordinate functions of the BSS 100. The AP 102 may transmit information to a single station selected from the plurality of stations STA1 to STA4 in the BSS 100 using a single frame, or may simultaneously transmit information to two or more of the stations STA1 to STA4 in the BSS 100 using either a single Orthogonal Frequency Division Multiplexing (OFDM) broadcast frame, a single OFDM Multi-User Multi-Input-Multi-Output (MU-MIMO) transmission, or a single Orthogonal Frequency Division Multiple Access (OFDMA) frame.

[0138] The stations STA1 to STA4 may each transmit data to the AP 102 using a single frame, or transmit information to and receive information from each other using a single frame. Two or more of the stations STA1 to STA4 may simultaneously transmit data to the AP 102 using an Uplink (UL) OFDMA frame. When the BSS 100 supports Spatial Division Multiple Access (SDMA), two or more of the stations STA1 to STA4 may simultaneously transmit data to the AP 102 using an UL MU-MIMO frame.

[0139] In another embodiment, the AP 102 may be absent and the stations STA1 to STA4 may be in an ad-hoc network.

[0140] Each of the stations STA1 to STA4 and the AP 102 includes a processor and a transceiver, and may further include a user interface and a display device.

[0141] The processor is configured to generate a frame to be transmitted through a wireless network, to process a frame received through the wireless network, and to execute protocols of the wireless network. The processor may perform some or all of its functions by executing computer programming instructions stored on a non-transitory computer-readable medium. The transceiver represents a unit functionally connected to the processor, and designed to transmit and receive a frame through the wireless network.

[0142] The transceiver may include a single component that performs the functions of transmitting and receiving, or two separate components each performing one of such functions. The processor and the transceiver may be implemented in each of the stations STA1 to STA4 and the AP 102 using respective hardware components, software components, or both.

[0143] The AP 102 may be or may include a WLAN router, a stand-alone Access Point, a WLAN bridge, a Light-Weight Access Point (LWAP) managed by a WLAN controller, and the like. In addition, a device such as a personal computer, tablet computer, or cellular phone may be able to operate as the AP 102, such as when a cellular phone is configured to operate as a wireless “hot spot.”

[0144] Each of the stations STA1 to STA4 may be or may include a desktop computer, a laptop computer, a tablet PC, a wireless phone, a mobile phone, a smart phone, an e-book reader, a Portable Multimedia Player (PMP), a portable game console, a navigation system, a digital camera, a Digital Multimedia Broadcasting (DMB) player, a digital audio recorder, a digital audio player, a digital picture recorder, a digital picture player, a digital video recorder, a digital video player, and the like.

[0145] The present disclosure may be applied to WLAN systems according to IEEE 802.11 standards but is not limited thereto.

[0146] In IEEE 802.11 standards, frames exchanged between stations (including access points) are classified into management frames, control frames, and data frames. A management frame may be a frame used for exchanging management information that is not forwarded to a higher layer of a communication protocol stack. A control frame may be a frame used for controlling access to a medium. A data frame may be a frame used for transmitting data to be forwarded to the higher layer of the communication protocol stack.

[0147] Each frame's type and subtype may be identified using a type field and a subtype field included in a control field of the frame, as prescribed in the applicable standard.

[0148] FIG. 2 illustrates a schematic block diagram of a wireless device 200 according to an embodiment. The wireless or WLAN device 200 can represent any device in a BSS, e.g., the AP 102 or any of the stations STA1 to STA4 in FIG. 1. The WLAN device 200 includes a baseband processor 210, a radio frequency (RF) transceiver 240, an antenna unit 250, a storage device (e.g., memory) 232, one or more input interfaces 234, and one or more output interfaces 236. The baseband processor 210, the memory 232, the input interfaces 234, the output interfaces 236, and the RF transceiver 240 may communicate with each other via a bus 260.

[0149] The baseband processor 210 performs baseband signal processing, and includes a MAC processor 212 and a PHY processor 222. The baseband processor 210 may utilize the storage device 232, which may include a non-transitory computer readable medium having software (e.g., computer programing instructions) and data stored therein.

[0150] In an embodiment, the MAC processor 212 includes a MAC software processing unit 214 and a MAC hardware processing unit 216. The MAC software processing unit 214 may implement a first plurality of functions of the MAC layer by executing MAC software, which may be included in the software stored in the storage device 232. The MAC hardware processing unit 216 may implement a second plurality of functions of the MAC layer in special-purpose hardware, hereinafter referred to as "MAC hardware." However, the MAC processor 212 is not limited thereto. For example, the MAC processor 212 may be configured to perform the first and second plurality of functions entirely in software or entirely in hardware according to an implementation.

[0151] The PHY processor 222 includes a transmitting signal processing unit 224 and a receiving signal processing unit 226. The PHY processor 222 implement a plurality of functions of the PHY layer. These functions may be performed in software, hardware, or a combination thereof according to implementation.

[0152] Functions performed by the transmitting signal processing unit 224 may include one or more of Forward Error Correction (FEC) encoding, stream parsing into one or more spatial streams, diversity encoding of the spatial streams into a plurality of space-time streams, spatial mapping of the space-time streams to transmit chains, inverse Fourier Transform (iFT) computation, Cyclic Prefix (CP) insertion to create a Guard Interval (GI), and the like.

[0153] The RF transceiver 240 includes an RF transmitter 242 and an RF receiver 244. The RF transceiver 240 is

configured to transmit first information received from the baseband processor 210 to the WLAN, and provide second information received from the WLAN to the baseband processor 210.

[0154] The antenna unit 250 includes one or more antennas. When Multiple-Input Multiple-Output (MIMO) or Multi-User MIMO (MU-MIMO) is used, the antenna unit 250 may include a plurality of antennas. In an embodiment, the antennas in the antenna unit 250 may operate as a beam-formed antenna array. In an embodiment, the antennas in the antenna unit 250 may be directional antennas, which may be fixed or steerable.

[0155] The input interfaces 234 receive information from a user, and the output interfaces 236 output information to the user. The input interfaces 234 may include one or more of a keyboard, keypad, mouse, touchscreen, touch screen, microphone, and the like. The output interfaces 236 may include one or more of a display device, touch screen, speaker, and the like.

[0156] As described herein, many functions of the WLAN device 200 may be implemented in either hardware or software. Which functions are implemented in software and which functions are implemented in hardware will vary according to constraints imposed on a design. The constraints may include one or more of design cost, manufacturing cost, time to market, power consumption, available semiconductor technology, and so on.

[0157] As described herein, a wide variety of electronic devices, circuits, firmware, software, and combinations thereof may be used to implement the functions of the components of the WLAN device 200. Furthermore, the WLAN device 200 may include other components, such as application processors, storage interfaces, clock generator circuits, power supply circuits, and the like, which have been omitted in the interest of brevity.

[0158] FIG. 3A illustrates components of a wireless device configured to transmit data according to an embodiment, including a Transmitting (Tx) Signal Processing Unit (TxSP) 324, an RF transmitter 342, and an antenna 352. In an embodiment, the TxSP 324, the RF transmitter 342, and the antenna 352 correspond to the transmitting signal processing unit 224, the RF transmitter 242, and an antenna of the antenna unit 250 of FIG. 2, respectively.

[0159] The TxSP 324 includes an encoder 300, an interleaver 302, a mapper 304, an inverse Fourier transformer (IFT) 306, and a guard interval (GI) inserter 308.

[0160] The encoder 300 receives and encodes input data. In an embodiment, the encoder 300 includes a forward error correction (FEC) encoder. The FEC encoder may include a binary convolutional code (BCC) encoder followed by a puncturing device. The FEC encoder may include a low-density parity-check (LDPC) encoder.

[0161] The TxSP 324 may further include a scrambler for scrambling the input data before the encoding is performed by the encoder 300 to reduce the probability of long sequences of 0s or 1s. When the encoder 300 performs the BCC encoding, the TxSP 324 may further include an encoder parser for demultiplexing the scrambled bits among a plurality of BCC encoders. If LDPC encoding is used in the encoder, the TxSP 324 may not use the encoder parser.

[0162] The interleaver 302 interleaves the bits of each stream output from the encoder 300 to change an order of bits therein. The interleaver 302 may apply the interleaving only when the encoder 300 performs the BCC encoding, and

otherwise may output the stream output from the encoder **300** without changing the order of the bits therein.

[0163] The mapper **304** maps the sequence of bits output from the interleaver **302** to constellation points. If the encoder **300** performed LDPC encoding, the mapper **304** may also perform LDPC tone mapping in addition to the constellation mapping.

[0164] When the TxSP **324** performs a MIMO or MU-MIMO transmission, the TxSP **324** may include a plurality of interleavers **302** and a plurality of mappers **304** according to a number NSS of spatial streams of the transmission. The TxSP **324** may further include a stream parser for dividing the output of the encoder **300** into blocks and may respectively send the blocks to different interleavers **302** or mappers **304**. The TxSP **324** may further include a space-time block code (STBC) encoder for spreading the constellation points from the spatial streams into a number NSTS of space-time streams and a spatial mapper for mapping the space-time streams to transmit chains. The spatial mapper may use direct mapping, spatial expansion, or beamforming.

[0165] The IFT **306** converts a block of the constellation points output from the mapper **304** (or, when MIMO or MU-MIMO is performed, the spatial mapper) to a time domain block (i.e., a symbol) by using an inverse discrete Fourier transform (IDFT) or an inverse fast Fourier transform (IFFT). If the STBC encoder and the spatial mapper are used, the IFT **306** may be provided for each transmit chain.

[0166] When the TxSP **324** performs a MIMO or MU-MIMO transmission, the TxSP **324** may insert cyclic shift diversities (CSDs) to prevent unintentional beamforming. The TxSP **324** may perform the insertion of the CSD before or after the IFT **306**. The CSD may be specified per transmit chain or may be specified per space-time stream. Alternatively, the CSD may be applied as a part of the spatial mapper.

[0167] When the TxSP **324** performs a MIMO or MU-MIMO transmission, some blocks before the spatial mapper may be provided for each user.

[0168] The GI inserter **308** prepends a GI to each symbol produced by the IFT **306**. Each GI may include a Cyclic Prefix (CP) corresponding to a repeated portion of the end of the symbol the GI precedes. The TxSP **324** may optionally perform windowing to smooth edges of each symbol after inserting the GI.

[0169] The RF transmitter **342** converts the symbols into an RF signal and transmits the RF signal via the antenna **352**. When the TxSP **324** performs a MIMO or MU-MIMO transmission, the GI inserter **308** and the RF transmitter **342** may be provided for each transmit chain.

[0170] FIG. 3B illustrates components of a wireless device configured to receive data according to an embodiment, including a Receiver (Rx) Signal Processing Unit (RxSP) **326**, an RF receiver **344**, and an antenna **354**. In an embodiment, the RxSP **326**, RF receiver **344**, and antenna **354** may correspond to the receiving signal processing unit **226**, the RF receiver **244**, and an antenna of the antenna unit **250** of FIG. 2, respectively.

[0171] The RxSP **326** includes a GI remover **318**, a Fourier transformer (FT) **316**, a demapper **314**, a deinterleaver **312**, and a decoder **310**.

[0172] The RF receiver **344** receives an RF signal via the antenna **354** and converts the RF signal into symbols. The GI remover **318** removes the GI from each of the symbols. When the received transmission is a MIMO or MU-MIMO

transmission, the RF receiver **344** and the GI remover **318** may be provided for each receive chain.

[0173] The FT **316** converts each symbol (that is, each time domain block) into a frequency domain block of constellation points by using a discrete Fourier transform (DFT) or a fast Fourier transform (FFT). The FT **316** may be provided for each receive chain.

[0174] When the received transmission is the MIMO or MU-MIMO transmission, the RxSP **326** may include a spatial demapper for converting the respective outputs of the FTs **316** of the receiver chains to constellation points of a plurality of space-time streams, and an STBC decoder for despreading the constellation points from the space-time streams into one or more spatial streams.

[0175] The demapper **314** demaps the constellation points output from the FT **316** or the STBC decoder to bit streams. If the received transmission was encoded using the LDPC encoding, the demapper **314** may further perform LDPC tone demapping before performing the constellation demapping.

[0176] The deinterleaver **312** deinterleaves the bits of each stream output from the demapper **314**. The deinterleaver **312** may perform the deinterleaving only when the received transmission was encoded using the BCC encoding, and otherwise may output the stream output by the demapper **314** without performing deinterleaving.

[0177] When the received transmission is the MIMO or MU-MIMO transmission, the RxSP **326** may use a plurality of demappers **314** and a plurality of deinterleavers **312** corresponding to the number of spatial streams of the transmission. In this case, the RxSP **326** may further include a stream deparser for combining the streams output from the deinterleavers **312**.

[0178] The decoder **310** decodes the streams output from the deinterleaver **312** or the stream deparser. In an embodiment, the decoder **312** includes an FEC decoder. The FEC decoder may include a BCC decoder or an LDPC decoder.

[0179] The RxSP **326** may further include a descrambler for descrambling the decoded data. When the decoder **310** performs the BCC decoding, the RxSP **326** may further include an encoder deparser for multiplexing the data decoded by a plurality of BCC decoders. When the decoder **310** performs the LDPC decoding, the RxSP **326** may not use the encoder deparser.

[0180] FIG. 4A illustrates an Orthogonal Frequency Division Multiple Access (OFDMA) frame **400** according to an embodiment. The OFDMA frame **400** may be a Down-Link (DL) Multi-User (MU) OFDMA frame transmitted by the AP **102** or an Up-Link (UL) MU OFDMA frame transmitted by a one or more of the stations STA1 to STA4 of the WLAN BSS **100** of FIG. 1. In the embodiment shown in FIG. 4, the OFDMA frame **400** is transmitted used a 20 MHz bandwidth, but embodiments are not limited thereto. Embodiments of the OFDMA frame **400** may be transmitted using any of a 40 MHz bandwidth, an 80 MHz bandwidth, an 80+80 MHz bandwidth, and a 160 MHz bandwidth.

[0181] The OFDMA frame **400** includes one or more data payloads, represented by first, second, and third data payloads **410**, **412**, and **414** respectively. The data payloads **410**, **412**, and **414** may be intended for respective first, second, and third stations.

[0182] A bandwidth of the OFDMA frame **400** is divided into one or more Resource Units (RUs), and each of the data

payloads **410**, **412**, and **414** is allocated one or more of the RUs. In an embodiment, an RU is allocated to no more than one data payload.

[0183] The OFDMA frame **400** may further include a High Efficient (HE) Signal A (HE-SIG-A) field **402**, an HE Signal B (HE-SIG-B) field **404**, an HE Short Training Field (HE-STF) **406**, and an HE Long Training Field (HE-LTF) **408**.

[0184] The HE-SIG-A field **402** may include information for interpreting the OFDMA frame **400**. The HE-SIG-B field **404**, when present, may include information concerning the allocation of Resource Units (RUs) within the OFDMA frame **400** and may include information used by specific stations (STAs) to decode respective payloads intended for them. The HE-STF **406** may include information for use in automatic gain control in a device receiving the OFDMA frame **400**.

[0185] The HE-LTF **408** includes information for estimating a channel between a WLAN device transmitting the OFDMA frame **400** and a WLAN device receiving the OFDMA frame **400**. The information in the HE-LTF **408** may also be used by the receiving WLAN device to track phase and frequency offsets. In an embodiment, the OFDMA frame **400** includes a plurality of HE-LTFs **408**.

[0186] Pilots exist in OFDM symbols of the data payloads **410**, **412**, and **414** and the symbols of the HE-LTF **408**. The pilots in the HE-LTF **408** may be used to compensate for CFO drift and to reduce channel estimation error for transmissions having a high number of spatial streams.

[0187] 802.11ax systems may support a first type and a second type of HE-LTF OFDM symbols. The first type may have a same number of subcarriers (i.e. tones) as data/pilot subcarriers. The second type may have approximately half of the number of information-carrying subcarriers (that is, carriers with energy) as data/pilot subcarriers. The first type of HE-LTF may be denoted as a 4×HE-LTF design and the second type of HE-LTF (with approximately half of the number of information-carrying subcarriers) may be denoted as a 2×HE-LTF design.

[0188] In an embodiment of the second type of HE-LTF, information is carried in every even tone, except for the DC tones. In another embodiment of the second type of HE-LTF, information is carried in every odd tone, except for the DC tones.

[0189] Accordingly, in an embodiment, the HE-LTF **408** includes a 2×HE-LTF **408-2×** according to the 2×LTF design. The 2×HE-LTF **408-2×** includes an OFDM symbol **422** and a Guard Interval (GI) **424**. The OFDM symbol **422** may have a duration of 6.4 microseconds.

[0190] As shown in FIG. 4B, the OFDM symbol **422** of the 2×HE-LTF **408-2×** may have an even mapping, that is, the OFDM symbol **422** only carry information in even-numbered tones (other than DC tones) within a bandwidth of the OFDM symbol **422**, that is, tones having an index equal to $2n$, where n is an integer. Arrows such as an arrow **430** indicate tones of the OFDM symbol **422** that may carry information. Tones without an arrow do not carry information.

[0191] As shown in FIG. 4C, the OFDM symbol **422** of the 2×HE-LTF **408-2×** may have an odd mapping, that is, the OFDM symbol **422** may only carry information in odd-numbered tones (other than DC tones) within a bandwidth of the OFDM symbol **422**, that is, tones having an index equal to $2n+1$, where n is an integer. Arrows such as an arrow **432**

indicate tones of the OFDM symbol **422** that may carry information. Tones without an arrow do not carry information.

[0192] In another embodiment, the HE-LTF **408** includes a 4×HE-LTF **408-4×** according to the 4×LTF design. The 4×HE-LTF **408-4×** includes an OFDM symbol **426** and a Guard Interval (GI) **428**. The OFDM symbol **426** may have a duration of 12.8 microseconds.

[0193] As shown in FIG. 4D, the OFDM symbol **426** of the 2×HE-LTF **408-4×** may carry information in all tones (other than DC tones) within a bandwidth of the OFDM symbol **426**. Arrows such as an arrow **434** indicate tones of the OFDM symbol **426** that may carry information.

[0194] Embodiments of the present disclosure include methods of providing pilots that support same and different FFT sizes for HE-LTF and data payload OFDM symbols.

[0195] In OFDMA operations, the operational bandwidth is divided up into resource units (RUs). There may be different RU sizes within the operational bandwidth, each RU size including a different number of subcarriers (i.e. tones). Examples of possible RUs for various bandwidths are shown in FIGS. 5A, 6, 7, 8A, and 9, described below. Depending on how the RUs are defined, RUs may start with an even numbered subcarrier (that is, RUs may be even RUs) or an odd numbered subcarrier (that is, RUs may be odd RUs).

[0196] FIG. 5A illustrates RUs definitions in a 20 MHz bandwidth **500** according to an embodiment. Within the 20 MHz bandwidth **500** may be defined first to ninth 26-subcarrier RUs **502**, **504**, **506**, **508**, **510**, **512**, **514**, **516**, and **518**. Within the 20 MHz bandwidth **500** may be also defined first to fourth 52-subcarrier RUs **522**, **524**, **526** and **528**. A 242-subcarrier RU **540** may also be defined within the 20 MHz bandwidth **500**.

[0197] In an embodiment, first and second 106-subcarrier RUs **532** and **534** may be defined in the 20 MHz bandwidth **500**. In another embodiment, first and second 108-subcarrier RUs **536** and **538** may be defined in the 20 MHz bandwidth **500**.

[0198] FIG. 5B includes a Table 1 indicating the size and lowest and highest subcarrier (SC) indexes of the RUs that may be defined in the 20 MHz bandwidth **500**. Table 1 also indicates whether an RU is considered an odd RU (that is, one that has a lowest SC index that is an odd integer) or an even RU (that is, one that has a lowest SC index that is an even integer.) Odd and even RUs are also indicated in FIG. 5A.

[0199] The fifth 26-subcarrier RU **510**, at the center of the 20 MHz bandwidth **500**, is not to be considered an odd RU or an even RU.

[0200] FIG. 6 illustrates RUs definitions in a 40 MHz bandwidth **600** according to an embodiment. Within the 40 MHz bandwidth **600** may be defined first to eighteenth 26-subcarrier RUs **602**, **604**, **606**, **608**, **610**, **612**, **614**, **616**, **618**, **642**, **644**, **646**, **648**, **650**, **652**, **654**, **656**, and **658**. Also defined may be first to eighth 62-subcarrier RUs **622**, **624**, **626**, **628**, **662**, **664**, **666** and **668**. First and second 242-subcarrier RUs **640** and **680** and a 484-subcarrier RU **682** may also be defined within the 40 MHz bandwidth **600**.

[0201] In an embodiment, first to fourth second 106-subcarrier RUs **632**, **634**, **662** and **664** may be defined in the 40 MHz bandwidth **600**. In another embodiment, first to fourth 108-subcarrier RUs **636**, **638**, **666**, and **668** may be defined in the 40 MHz bandwidth **600**.

[0202] In an embodiment, lowest and highest SC indexes of the RUs **602** to **638** of FIG. **6** are the same, within a first 20 MHz subchannel of the 40 MHz bandwidth **600**, as the lowest and highest SC indexes of the similarly numbered RUs **502** to **538** of FIGS. **5A** and **5B**, respectively. Lowest and highest SC indexes of the RUs **642** to **668** of FIG. **6** are the same, within a second 20 MHz subchannel of the 40 MHz bandwidth **600**, as the lowest and highest SC indexes of the corresponding RUs **502** to **538** of FIGS. **5A** and **5B**, respectively.

[0203] The odd and even RUs of the 40 MHz bandwidth **600** are indicated by labels of the RUs.

[0204] Within this disclosure, the definitions of the RUs illustrated in FIGS. **5A** and **6** are denoted as case 1.

[0205] FIG. **7** illustrates RUs defined within an 80 MHz bandwidth **700**. The defined RUs include thirty-six 26-subcarrier RUs **702** to **721** and **742** to **761**, sixteen 52-subcarrier RUs **722** to **729** and **762** to **769**, four 242-subcarrier RUs **740**, **741**, **780**, and **781**, two 484-subcarrier RUs **782** and **783**, and a 996-subcarrier RU **784**.

[0206] The defined RUs in the 80 MHz bandwidth **700** also include eight RUs that may be 106-subcarrier RUs in an embodiment or 108-subcarrier RUs in another embodiment. The eight 106-or-108-subcarrier RUs are designated by reference characters **732** to **735** and **772** to **775**.

[0207] FIGS. **8A** and **9** illustrate alternative RU definitions for 20 and 40 MHz bandwidths, respectively. Within this disclosure, the definitions of the RUs illustrated in FIGS. **8A** and **9** are denoted as case 2.

[0208] FIG. **8A** illustrates RUs definitions in a 20 MHz bandwidth **800** according to another embodiment. Within the 20 MHz bandwidth **800** are defined first to ninth 26-subcarrier RUs **802**, **804**, **806**, **808**, **810**, **812**, **814**, **816**, and **818**. Also defined are first to fourth 52-subcarrier RUs **822**, **824**, **826** and **828**. A 242-subcarrier RU **840** may also be defined within the 20 MHz bandwidth **800**.

[0209] In an embodiment, first and second 106-subcarrier RUs **832** and **834** may be defined in the 20 MHz bandwidth **800**. In another embodiment, first and second 108-subcarrier RUs **836** and **838** may be defined in the 20 MHz bandwidth **800**.

[0210] FIG. **8B** includes a Table 2 indicating the size and lowest and highest subcarrier (SC) indexes of the RUs that may be defined in the 20 MHz bandwidth **800**. Table 1 also indicates whether an RU is considered an odd RU (that is, one that has a lowest SC index that is an odd integer) or an even RU (that is, one that has a lowest SC index that is an even integer.) Odd and even RUs are also indicated in FIG. **8A**.

[0211] The fifth 26-subcarrier RU **810**, at the center of the 20 MHz bandwidth **800**, is not to be considered an odd RU or an even RU.

[0212] FIG. **9** illustrates RUs definitions in a 40 MHz bandwidth **900** according to another embodiment. Within the 40 MHz bandwidth **900** are defined first to eighteenth 26-subcarrier RUs **902**, **904**, **906**, **908**, **910**, **912**, **914**, **916**, **918**, **942**, **944**, **946**, **948**, **950**, **952**, **954**, **956**, and **958**. Also defined are first to eighth 52-subcarrier RUs **922**, **924**, **926**, **928**, **962**, **964**, **966** and **968**. First and second 242-subcarrier RUs **940** and **980** and a 484-subcarrier RU **982** may also be defined within the 40 MHz bandwidth **900**.

[0213] In an embodiment, first to fourth second 106-subcarrier RUs **932**, **934**, **962** and **964** may be defined in the 40 MHz bandwidth **900**. In another embodiment, first to

fourth 108-subcarrier RUs **936**, **938**, **966**, and **968** may be defined in the 40 MHz bandwidth **900**.

[0214] In an embodiment, lowest and highest SC indexes of the RUs **902** to **938** of FIG. **9** are the same, within a first 20 MHz subchannel of the 40 MHz bandwidth **900**, as the lowest and highest SC indexes of the similarly numbered RUs **802** to **838** of FIGS. **8A** and **8B**, respectively. Lowest and highest SC indexes of the RUs **942** to **968** of FIG. **9** are the same, within a second 20 MHz subchannel of the 40 MHz bandwidth **900**, as the lowest and highest SC indexes of the corresponding RUs **802** to **838** of FIGS. **8A** and **8B**, respectively.

[0215] The odd and even RUs of the 40 MHz bandwidth **900** are indicated by labels of the RUs.

1. Pilot Tone Mapping Symmetry Between Even and Odd Resource Units

[0216] In an embodiment, even and odd RUs may have pilot tone positions that exhibit mirror symmetry. FIG. **10** illustrates positions of pilot tone positions in an even RU **1000** according to an embodiment. FIG. **11** illustrates positions of pilot tone positions in an odd RU **1100** according to an embodiment, the positions of the pilot tone positions in the odd RU **1100** having mirror symmetry relative to the positions of the pilot tone positions of the even RU **1000**. The even RU **1000** and the odd RU **1100** have a same size, that is, a same number (26) of subcarriers.

[0217] In FIGS. **10** and **11**, hash marks along the horizontal access correspond to odd subcarriers that respectively do not correspond to subcarriers having energy of a 2xHE-LTF. Upward pointing arrows along the horizontal access respectively correspond to even subcarriers that correspond to the subcarriers having energy of the 2xHE-LTF.

[0218] The even RU **1000** includes first and second pilot tone positions **1004** and **1006**. The first pilot tone position **1004** corresponds to a subcarrier spaced 6 subcarriers away from a lowest-indexed subcarrier of the even RU **1000**. The second pilot tone position **1006** corresponds to a subcarrier separated by 11 subcarriers from the first pilot tone position **1004** and spaced 7 subcarriers away from a highest-indexed subcarrier of the even RU **1000**.

[0219] The odd RU **1100** includes third and fourth pilot tone positions **1104** and **1106** which are mirror-symmetric to the first and second pilot tone positions **1004** and **1006**, respectively. Accordingly, the third pilot tone position **1104** corresponds to a subcarrier spaced 6 subcarriers away from a highest-indexed subcarrier of the odd RU **1100**. The fourth pilot tone position **1106** corresponds to a subcarrier separated by 11 subcarriers from the third pilot tone position **1104** and spaced 7 subcarriers away from a lowest-indexed subcarrier of the odd RU **1100**.

[0220] This produces mirror symmetric pilot tone positions between an even RU and an odd RU of the same size, when the even RU and the odd RU are adjacent to each other.

2. Nested and Non-Nested Pilot Structure

[0221] In an embodiment, pilot tone positions may have a nested pilot structure. In another embodiment, pilot tone positions may have a non-nested pilot structure.

[0222] In the nested pilot structure, for a given operation bandwidth (such as 40 MHz or 80 MHz) the pilot tone positions for RUs having larger number of subcarriers are

physically aligned (in frequency domain) with pilot tone positions for RUs having smaller numbers of subcarriers. The nested pilot structure may simplify a Carrier Frequency Offset (CFO) tracking algorithm of a receiver configured to receive frames including RU allocations having varied sizes and varied positions.

[0223] In the non-nested pilot structure, pilot tone positions are defined for each RU size in such a manner as to maximize CFO tracking performance. The non-nested pilot structure may have a uniform spacing of pilots within an RU.

3. Design A: Non-Nested Pilot Structure

[0224] In embodiment according to a design-A principle having a non-nested pilot structure, cases may occur in which pilots are mapped to locations that correspond to null tones (that is, tones not carrying information) of a 2×HE-LTF, since information in the 2×HE-LTF sequence is only mapped to either even or odd tones in a given OFDM symbol.

[0225] Embodiments of the design-A principle include alternative 1 and alternative 2. Alternative 1 defines the pilot tone positions such that the pilot tone positions never correspond to locations of null tones of an HE-LTF OFDM symbol.

[0226] Alternative 2 defines the pilot tone positions such that pilot spacing is uniform, without regards to whether the pilot tone positions correspond to locations of null tones of the HE-LTF OFDM symbol. As a result, an HE-LTF OFDM symbol according to Alternative 2 of Design A may lack one or more pilots present in the data payload OFDM symbols.

4. Design A, Alternative 1: Pilots are not Mapped to Null LTF Tones

[0227] FIGS. 10 and 11 both illustrates a general concept for embodiments of alternative 1 of Design-A. In order to ensure that pilots are always mapped to non-null tones of an HE-LTF of the 2×LTF design, the tone spacing between two consecutive pilot tone positions (that is, the number of tones/subcarriers between two consecutive pilot tone positions) should be an odd number.

[0228] Accordingly in FIG. 10 the second pilot tone position 1006 corresponds to a subcarrier separated by 11 subcarriers from the first pilot tone position 1004, and in FIG. 11 the third pilot tone position 1104 corresponds to a subcarrier separated by 11 subcarriers from the fourth pilot tone position 1106. That is, the tone spacing between the pilot tone positions in each of FIGS. 10 and 11 is 11 subcarriers.

[0229] This ensures that pilot tone positions are mapped to 2×HE-LTF sequence mapping positions (i.e. subcarriers that carry information in a 2×LTF design).

[0230] In all of FIGS. 12-22, the upward arrows extending from the horizontal axis represents subcarriers corresponding to potential 2×HE-LTF sequence mapping positions from the 2×LTF design, and the hash marks on the axis represent subcarriers that do not corresponding to potential 2×HE-LTF sequence mapping positions from the 2×LTF design. The dash-dotted lines on the most left and right part of the figure represent the boundaries of the RU.

[0231] FIGS. 12 and 13 illustrate RUs having a spacing between pilot subcarrier positions of 13 subcarriers according to an embodiment of alternative 1 of Design A.

[0232] In an embodiment of alternative 1 of design A that includes an even tone mapping of an HE-LTF sequence in a 2×LTF design, FIG. 12 illustrates pilot tone positions for an even 26-subcarrier RU 1200, and FIG. 13 illustrates pilot tone positions for an odd 26-subcarrier RU 1300.

[0233] In the embodiment including the even tone mapping of the HE-LTF sequence, a lowest subcarrier index f_0 of the even RU 1200 is equal to $2n$, and a lowest subcarrier index f_0' of the odd RU 1300 is equal to $2n+1$, where n is an integer. In an embodiment, the lowest subcarrier index f_0 of either of RU 1200 and 1300 may be one of -122 , -68 , $+16$, and $+70$ when even and one of -95 , -41 , $+43$, and $+97$ when odd. In an embodiment for 20 MHz bandwidth, the lowest subcarrier index f_0 of either of RU 1200 and 1300 may be one of -68 , -42 , $+70$, and $+96$ when even and one of -121 , -95 , $+17$, and $+43$ when odd. In an embodiment for 40 MHz bandwidth, the lowest subcarrier index f_0 of either of RU 1200 and 1300 may be one of -136 , 4 , 30 , 58 , 84 , 138 , 164 , 192 , and 218 when even and one of -243 , -217 , -189 , -163 , -109 , -83 , -55 , -29 , and 111 when odd. In an embodiment for 80 MHz bandwidth, the lowest subcarrier index f_0 of either of RU 1200 and 1300 may be one of -392 , -150 , $+18$, $+44$, $+72$, $+98$, $+152$, $+178$, $+206$, $+232$, $+260$, $+286$, $+314$, $+340$, $+394$, $+420$, $+448$, and $+474$ when even and one of -499 , -473 , -445 , -419 , -365 , -339 , -311 , -285 , -257 , -231 , -203 , -177 , -123 , -97 , -69 , -43 , $+125$, and $+367$ when odd. In an embodiment for 160 MHz bandwidth, the lowest subcarrier index f_0 of either of RU 1200 and 1300 may be one of -1011 , -985 , -957 , -931 , -877 , -851 , -823 , -797 , -769 , -743 , -715 , -689 , -635 , -609 , -581 , -555 , -387 , -145 , $+13$, $+39$, $+67$, $+93$, $+147$, $+173$, $+201$, $+227$, $+255$, $+281$, $+309$, $+335$, $+389$, $+415$, $+443$, $+469$, $+637$, and $+879$ when even and one of -904 , -662 , -494 , -468 , -440 , -414 , -360 , -334 , -306 , -280 , -252 , -226 , -198 , -172 , -118 , -92 , -64 , -38 , $+120$, $+362$, $+530$, $+556$, $+584$, $+610$, $+664$, $+690$, $+718$, $+744$, $+772$, $+798$, $+826$, $+852$, $+906$, $+932$, $+960$, $+986$ when odd.

[0234] A first pilot tone position 1204 of the even RU 1200 is spaced 6 subcarriers away from a lowest subcarrier of the even RU 1200. A second pilot tone position 1206 of the even RU 1200 is separated by 13 subcarriers from the first pilot tone position 1204 and 5 subcarriers away from a highest subcarrier of the even RU 1200. If the lowest subcarrier of the even RU 1200 is equal to f_0 , two pilots are located at the (f_0+6) -th subcarrier and the (f_0+20) -th subcarrier.

[0235] A first pilot tone position 1304 of the odd RU 1300 is spaced 5 subcarriers away from a lowest subcarrier of the odd RU 1300. A second pilot tone position 1306 of the odd RU 1300 is separated by 13 subcarriers from the first pilot tone position 1304 and 6 subcarriers away from a highest subcarrier of the odd RU 1300. If the lowest subcarrier of the even RU 1200 is equal to f_0 , two pilots are located at the (f_0+5) -th subcarrier and the (f_0+19) -th subcarrier.

[0236] In another embodiment of alternative 1 of design A that includes an odd tone mapping of an HE-LTF sequence in a 2×LTF design, FIG. 12 illustrates pilot tone positions for an odd 26-subcarrier RU, and FIG. 13 illustrates pilot tone positions for an even 26-subcarrier RUs.

[0237] In the embodiment including the odd tone mapping of the HE-LTF sequence, a lowest subcarrier index f_0 of the odd RU 1200 is equal to $2n+1$, and a lowest subcarrier index f_0' of the even RU 1300 is equal to $2n$, where n is an integer. In an embodiment, the lowest subcarrier indexes f_0 and f_0' of

either of RU **1200** and **1300** is one of $-122, -68, +16,$ and $+70$ when even and one of $-95, -41, +43,$ and $+97$ when odd.

[0238] A first pilot tone position **1204** of the odd RU **1200** is spaced 6 subcarriers away from a lowest subcarrier of the odd RU **1200**. A second pilot tone position **1206** of the odd RU **1200** is separated by 13 subcarriers from the first pilot tone position **1204** and spaced 5 subcarriers away from a highest subcarrier of the odd RU **1200**.

[0239] A first pilot tone position **1304** of the even RU **1300** is spaced 5 subcarriers away from a lowest subcarrier of the even RU **1300**. A second pilot tone position **1306** of the even RU **1300** is separated by 13 subcarriers from the first pilot tone position **1304** and spaced 6 subcarriers away from a highest subcarrier of the even RU **1300**.

[0240] FIGS. **14** and **15** illustrate RUs having a spacing between pilot subcarrier positions of 11 subcarriers according to an embodiment of alternative 1 of Design A.

[0241] In an embodiment of alternative 1 of design A that includes an even tone mapping of an HE-LTF sequence in a $2\times$ LTF design, FIG. **14** illustrates pilot tone positions for an even 26-subcarrier RU **1400**, and FIG. **15** illustrates pilot tone positions for an odd 26-subcarrier RU **1500**.

[0242] In the embodiment including the even tone mapping of the HE-LTF sequence, a lowest subcarrier index f_0 of the even RU **1400** is equal to $2n$, and a lowest subcarrier index f_0' of the odd RU **1500** is equal to $2n+1$, where n is an integer. In an embodiment, the lowest subcarrier indexes f_0 and f_0' of either of RU **1400** and **1500** is one of $-122, -68, +16,$ and $+70$ when even and one of $-95, -41, +43,$ and $+97$ when odd.

[0243] A first pilot tone position **1404** of the even RU **1400** is spaced 6 subcarriers away from a lowest subcarrier of the even RU **1400**. A second pilot tone position **1406** of the even RU **1400** is separated by 11 subcarriers from the first pilot tone position **1404** and spaced 7 subcarriers away from a highest subcarrier of the even RU **1400**.

[0244] A first pilot tone position **1504** of the odd RU **1500** is spaced 7 subcarriers away from a lowest subcarrier of the odd RU **1500**. A second pilot tone position **1506** of the odd RU **1500** is separated by 11 subcarriers from the first pilot tone position **1504** and spaced 6 subcarriers away from a highest subcarrier of the odd RU **1500**.

[0245] In another embodiment of alternative 1 of design A that includes an odd tone mapping of an HE-LTF sequence in a $2\times$ LTF design, FIG. **14** illustrates pilot tone positions for an odd 26-subcarrier RU, and FIG. **15** illustrates pilot tone positions for an even 26-subcarrier RUs.

[0246] In the embodiment including the odd tone mapping of the HE-LTF sequence, a lowest subcarrier index f_0 of the odd RU **1400** is equal to $2n+1$, and a lowest subcarrier index f_0' of the even RU **1500** is equal to $2n$, where n is an integer. In an embodiment, the lowest subcarrier indexes f_0 and f_0' of either of RU **1400** and **1500** is one of $-122, -68, +16,$ and $+70$ when even and one of $-95, -41, +43,$ and $+97$ when odd.

[0247] A first pilot tone position **1404** of the odd RU **1400** is spaced 6 subcarriers away from a lowest subcarrier of the odd RU **1400**. A second pilot tone position **1406** of the odd RU **1400** is separated by 11 subcarriers from the first pilot tone position **1404** and spaced 7 subcarriers away from a highest subcarrier of the odd RU **1400**.

[0248] A first pilot tone position **1504** of the even RU **1500** is spaced 7 subcarriers away from a lowest subcarrier of the

even RU **1500**. A second pilot tone position **1506** of the even RU **1500** is separated by 11 subcarriers from the first pilot tone position **1504** and spaced 6 subcarriers away from a highest subcarrier of the even RU **1500**.

[0249] FIG. **16** illustrates a center 26-subcarrier RU **1600** according to an embodiment of alternative 1 of design A that includes an even tone mapping of an HE-LTF sequence in a $2\times$ LTF design. The center RU **1600** is split into a left 13-subcarrier unit and a right 13-subcarrier unit by one of 3, 5, and 7 Direct Current (DC) tones within a central portion **1602**.

[0250] When the center RU **1600** includes 3 DC tones, a lowest subcarrier index f_0 of the left 13-subcarrier unit may be -14 and a lowest subcarrier index f_1 of the right 13-subcarrier unit may be $+2$. When the center RU **1600** includes 5 DC tones, the left lowest subcarrier index f_0 may be -15 and the right lowest subcarrier index f_1 of the center RU **1600** may be $+3$. When the center RU **1600** includes 7 DC tones, the left lowest subcarrier index f_0 may be -16 and the right lowest subcarrier index f_1 of the center RU **1600** may be $+4$.

[0251] A first pilot tone position **1604** of the center RU **1600** is spaced 6 subcarriers away from a lowest subcarrier of the center RU **1600** and 6 subcarriers away from the central portion **1602**. A second pilot tone position **1606** of the center RU **1600** is spaced 6 subcarriers away from a highest subcarrier of the center RU **1600** and 6 subcarriers away from the central portion **1602**. Two pilots are located at the (f_0+6) -th subcarrier and the (f_1+6) -th subcarrier.

[0252] The first pilot tone position **1604** is located at a center of 13 subcarriers of a left portion of the center RU **1600**. The second pilot tone position **1606** is located at a center of 13 subcarriers of a right portion of the center RU **1600**.

[0253] FIG. **17** illustrates a center 26-subcarrier RU **1700** according to an embodiment of alternative 1 of design A that includes an odd tone mapping of an HE-LTF sequence in a $2\times$ LTF design. The center RU **1700** may include one of 3, 5, and 7 Direct Current (DC) tones within a central portion **1702**.

[0254] When the center RU **1700** includes 3 DC tones, a left lowest subcarrier index f_0 may be -14 and a right lowest subcarrier index f_1 of the center RU **1700** may be $+2$. When the center RU **1700** includes 5 DC tones, the left lowest subcarrier index f_0 may be -15 and the right lowest subcarrier index f_1 of the center RU **1700** may be $+3$. When the center RU **1700** includes 7 DC tones, the left lowest subcarrier index f_0 may be -16 and the right lowest subcarrier index f_1 of the center RU **1700** may be $+4$.

[0255] A first pilot tone position **1704** of the center RU **1700** is spaced 5 subcarriers away from a lowest subcarrier of the even RU **1700** and 7 subcarriers away from the central portion **1702**. A second pilot tone position **1706** of the center RU **1700** is spaced 5 subcarriers away from a highest subcarrier of the center RU **1700** and 7 subcarriers away from the central portion **1702**.

[0256] FIG. **18** illustrates a center 26-subcarrier RU **1800** according to an embodiment of alternative 1 of design A that includes an odd tone mapping of an HE-LTF sequence in a $2\times$ LTF design. The center RU **1800** may include one of 3, 5, and 7 Direct Current (DC) tones within a central portion **1802**.

[0257] When the center RU **1800** includes 3 DC tones, a left lowest subcarrier index f_0 may be -14 and a right lowest

subcarrier index f_1 of the center RU **1800** may be +2. When the center RU **1800** includes 5 DC tones, the left lowest subcarrier index f_0 may be -15 and the right lowest subcarrier index f_1 of the center RU **1800** may be +3. When the center RU **1800** includes 7 DC tones, the left lowest subcarrier index f_0 may be -16 and the right lowest subcarrier index f_1 of the center RU **1800** may be +4.

[0258] A first pilot tone position **1804** of the center RU **1800** is spaced 7 subcarriers away from a lowest subcarrier of the even RU **1800** and 5 subcarriers away from the central portion **1802**. A second pilot tone position **1806** of the center RU **1800** is spaced 7 subcarriers away from a highest subcarrier of the center RU **1800** and 5 subcarriers away from the central portion **1802**.

[0259] FIGS. **19** and **20** illustrate 52-subchannel RUs having a spacing between first, second, third, and fourth pilot subcarrier positions of 13, 11, and 13 subcarriers, respectively, according to an embodiment of alternative 1 of Design A.

[0260] In an embodiment of alternative 1 of design A that includes an even tone mapping of an HE-LTF sequence in a 2xLTF design, FIG. **19** illustrates pilot tone positions for an even 52-subcarrier RU **1900**, and FIG. **20** illustrates pilot tone positions for an odd 52-subcarrier RU **2000**.

[0261] In the embodiment including the even tone mapping of the HE-LTF sequence, a lowest subcarrier index f_0 of the even RU **1900** is equal to $2n$, and a lowest subcarrier index f_0' of the odd RU **2000** is equal to $2n+1$, where n is an integer. In an embodiment, the lowest subcarrier indexes f_0 and f_0' of either of RU **1900** and **2000** is one of -122, -68, +16, and +70 when even and one of -95, -41, +43, and +97 when odd. In an embodiment for 20 MHz bandwidth, the lowest subcarrier index f_0 of either of RU **1200** and **1300** may be one of -68 and +70 when even and one of -121 and +17 when odd. In an embodiment for 40 MHz bandwidth, the lowest subcarrier index f_0 of either of RU **1200** and **1300** may be one of 4, 58, 138, and 192 when even and one of -243, -189, -109, and -55 when odd. In an embodiment for 80 MHz bandwidth, the lowest subcarrier index f_0 of either of RU **1200** and **1300** may be one of +18, +72, +152, +206, +260, +314, +394 and +448 when even and one of -499, -445, -365, -311, -257, -203, -123 and -69 when odd. In an embodiment for the 160 MHz bandwidth, the lowest subcarrier index f_0 of either of RU **1200** and **1300** may be one of -494, -440, -360, -306, -252, -198, -118, -64, +530, +584, +664, +718, +772, +826, +906 and +960 when even and one of -1011, -957, -877, -823, -769, -715, -635, -581, +13, +67, +147, +201, +255, +309, +389 and +443 when odd.

[0262] A first pilot tone position **1904** of the even RU **1900** is spaced 6 subcarriers away from a lowest subcarrier of the even RU **1900**. A second pilot tone position **1906** of the even RU **1900** is separated by 13 subcarriers from the first pilot tone position **1904**. A third pilot tone position **1908** of the even RU **1900** is separated by 11 subcarriers from the second pilot tone position **1906**. A fourth pilot tone position **1910** of the even RU **1900** is separated by 13 subcarriers from the third pilot tone position **1908** and spaced 5 subcarriers away from a highest subcarrier of the even RU **1900**. If the lowest subcarrier of the even RU **1900** is equal to f_0 , four pilots are located at the (f_0+6) -th subcarrier, the (f_0+20) -th subcarrier, the (f_0+32) -th subcarrier and the (f_0+46) -th subcarrier, respectively.

[0263] A first pilot tone position **2004** of the odd RU **2000** is spaced 5 subcarriers away from a lowest subcarrier of the odd RU **2000**. A second pilot tone position **2006** of the odd RU **2000** is separated by 13 subcarriers from the first pilot tone position **2004**. A third pilot tone position **2008** of the odd RU **2000** is separated by 11 subcarriers from the second pilot tone position **2006**. A fourth pilot tone position **2010** of the odd RU **2000** is separated by 13 subcarriers from the third pilot tone position **2008** and spaced 6 subcarriers away from a highest subcarrier of the odd RU **2000**. If the lowest subcarrier of the odd RU **1900** is equal to f_0' , four pilots are located at the $(f_0'+6)$ -th subcarrier, the $(f_0'+20)$ -th subcarrier, the $(f_0'+32)$ -th subcarrier and the $(f_0'+46)$ -th subcarrier, respectively.

[0264] In another embodiment of alternative 1 of design A that includes an odd tone mapping of an HE-LTF sequence in a 2xLTF design, FIG. **19** illustrates pilot tone positions for an odd 52-subcarrier RU **1900**, and FIG. **20** illustrates pilot tone positions for an even 52-subcarrier RU **2000**.

[0265] In the embodiment including the odd tone mapping of the HE-LTF sequence, a lowest subcarrier index f_0 of the odd RU **1900** is equal to $2n+1$, and a lowest subcarrier index f_0' of the even RU **2000** is equal to $2n$, where n is an integer. In an embodiment, the lowest subcarrier indexes f_0 and f_0' of either of RU **1900** and **2000** is one of -122, -68, +16, and +70 when even and one of -95, -41, +43, and +97 when odd.

[0266] A first pilot tone position **1904** of the odd RU **1900** is spaced 6 subcarriers away from a lowest subcarrier of the odd RU **1900**. A second pilot tone position **1906** of the odd RU **1900** is separated by 13 subcarriers from the first pilot tone position **1904**. A third pilot tone position **1908** of the odd RU **1900** is separated by 11 subcarriers from the second pilot tone position **1906**. A fourth pilot tone position **1910** of the odd RU **1900** is separated by 13 subcarriers from the third pilot tone position **1908** and spaced 5 subcarriers away from a highest subcarrier of the odd RU **1900**.

[0267] A first pilot tone position **2004** of the even RU **2000** is spaced 5 subcarriers away from a lowest subcarrier of the even RU **2000**. A second pilot tone position **2006** of the even RU **2000** is separated by 13 subcarriers from the first pilot tone position **2004**. A third pilot tone position **2008** of the even RU **2000** is separated by 11 subcarriers from the second pilot tone position **2006**. A fourth pilot tone position **2010** of the even RU **2000** is separated by 13 subcarriers from the third pilot tone position **2008** and spaced 6 subcarriers away from a highest subcarrier of the even RU **2000**.

[0268] FIGS. **21** and **22** illustrate 52-subchannel RUs having a spacing between first, second, third, and fourth pilot subcarrier positions of 11, 13, and 11 subcarriers, respectively, according to an embodiment of alternative 1 of Design A.

[0269] In an embodiment of alternative 1 of design A that includes an even tone mapping of an HE-LTF sequence in a 2xLTF design, FIG. **21** illustrates pilot tone positions for an even 52-subcarrier RU **2100**, and FIG. **22** illustrates pilot tone positions for an odd 52-subcarrier RU **2200**.

[0270] In the embodiment including the even tone mapping of the HE-LTF sequence, a lowest subcarrier index f_0 of the even RU **2100** is equal to $2n$, and a lowest subcarrier index f_0' of the odd RU **2200** is equal to $2n+1$, where n is an integer. In an embodiment, the lowest subcarrier index f_0 of

either of RU **2100** and **2200** is one of -122 , -68 , $+16$, and $+70$ when even and one of -95 , -41 , $+43$, and $+97$ when odd.

[0271] A first pilot tone position **2104** of the even RU **2100** is spaced 6 subcarriers away from a lowest subcarrier of the even RU **2100**. A second pilot tone position **2106** of the even RU **2100** is separated by 11 subcarriers from the first pilot tone position **2104**. A third pilot tone position **2108** of the even RU **2100** is separated by 13 subcarriers from the second pilot tone position **2106**. A fourth pilot tone position **2110** of the even RU **2100** is separated by 11 subcarriers from the third pilot tone position **2108** and spaced 7 subcarriers away from a highest subcarrier of the even RU **2100**.

[0272] A first pilot tone position **2204** of the odd RU **2200** is spaced 7 subcarriers away from a lowest subcarrier of the odd RU **2200**. A second pilot tone position **2206** of the odd RU **2200** is separated by 11 subcarriers from the first pilot tone position **2204**. A third pilot tone position **2208** of the odd RU **2200** is separated by 13 subcarriers from the second pilot tone position **2206**. A fourth pilot tone position **2210** of the odd RU **2200** is separated by 11 subcarriers from the third pilot tone position **2208** and spaced 6 subcarriers away from a highest subcarrier of the odd RU **2200**.

[0273] In another embodiment of alternative 1 of design A that includes an odd tone mapping of an HE-LTF sequence in a $2\times$ LTF design, FIG. 21 illustrates pilot tone positions for an odd 52-subcarrier RU, and FIG. 22 illustrates pilot tone positions for an even 52-subcarrier RUs.

[0274] In the embodiment including the odd tone mapping of the HE-LTF sequence, a lowest subcarrier index f_0 of the odd RU **2100** is equal to $2n+1$, and a lowest subcarrier index f_0' of the even RU **2200** is equal to $2n$, where n is an integer. In an embodiment, the lowest subcarrier indexes f_0 and f_0' of either of RU **2100** and **2200** is one of -122 , -68 , $+16$, and $+70$ when even and one of -95 , -41 , $+43$, and $+97$ when odd.

[0275] A first pilot tone position **2104** of the odd RU **2100** is spaced 6 subcarriers away from a lowest subcarrier of the odd RU **2100**. A second pilot tone position **2106** of the odd RU **2100** is separated by 11 subcarriers from the first pilot tone position **2104**. A third pilot tone position **2108** of the odd RU **2100** is separated by 13 subcarriers from the second pilot tone position **2106**. A fourth pilot tone position **2110** of the odd RU **2100** is separated by 11 subcarriers from the third pilot tone position **2108** and spaced 7 subcarriers away from a highest subcarrier of the odd RU **2100**.

[0276] A first pilot tone position **2204** of the even RU **2200** is spaced 7 subcarriers away from a lowest subcarrier of the even RU **2200**. A second pilot tone position **2206** of the even RU **2200** is separated by 11 subcarriers from the first pilot tone position **2204**. A third pilot tone position **2208** of the even RU **2200** is separated by 13 subcarriers from the second pilot tone position **2206**. A fourth pilot tone position **2210** of the even RU **2200** is separated by 11 subcarriers from the third pilot tone position **2208** and spaced 6 subcarriers away from a highest subcarrier of the even RU **2200**.

[0277] FIG. 23 includes a Table 3 that indicates pilot tone positions for six embodiments of alternative 1 of design A for 106-subcarrier RUs. The embodiments include three spacing options a, b, and c for each of two mappings (even or odd) of an HE-LTF sequence in a $2\times$ LTF design.

[0278] Table 3 includes three columns corresponding to the spacing options a, b, and c, respectively. Each column is composed of two subcolumns, i) an “EVEN/EVEN or

ODD/ODD” subcolumn indicating positions in either even RUs when an even mapping of the HE-LTF is used or odd RUs when an odd mapping of the HE-LTF is used, and ii) an “ODD/EVEN or EVEN/ODD” subcolumn indicating positions in either the even RUs when the odd mapping of the HE-LTF is used or the odd RUs when the even mapping of the HE-LTF is used.

[0279] In each row, each column indicates a subcarrier position (SC) of an element (such as an edge carrier or a pilot tone) corresponding to the row and a spacing (or Gap) between the element corresponding to the row and the element corresponding to the next row.

[0280] In each case, the edge carriers of the RU includes a lowest subcarrier (low SC) having an index of 0, and a highest subcarrier (high SC) having an index of 105.

[0281] For a first example, in an embodiment of option a of alternative 1 of design A having an even tone mapping of an HE-LTF sequence in the $2\times$ LTF design, first to fourth pilots of even RUs are respectively located at indexes of $+14$, $+40$, $+66$, and $+92$, respectively. First to fourth pilots of odd RUs are respectively located at indexes of $+13$, $+39$, $+65$, and $+91$, respectively.

[0282] In the first example, the positions of the pilot tone positions in the even and odd RUs are mirror symmetric. That is, the spacing between the pilot tone positions and edge subcarriers, starting from the lowest subcarrier, are 14, 25, 25, 25, and 13 in the even RUs and 13, 25, 25, 25, and 14 in the odd RUs.

[0283] For a second example, in an embodiment of option b of alternative 1 of design A having an odd tone mapping of an HE-LTF sequence in the $2\times$ LTF design, first to fourth pilots of even RUs are respectively located at indexes of $+15$, $+41$, $+67$, and $+93$, respectively. First to fourth pilots of odd RUs are respectively located at indexes of $+12$, $+38$, $+64$, and $+90$, respectively.

[0284] As in the first example, in the second example, the positions of the pilot tone positions in the even and odd RUs are mirror symmetric. That is, the spacing between the pilot tone positions and edge subcarriers, starting from the lowest subcarrier, are 15, 25, 25, 25, and 12 in the even RUs and 12, 25, 25, 25, and 15 in the odd RUs.

[0285] Table 3 illustrates that in every combination of i) one of option a, b, and c, and ii) one of an even and odd tone mapping of an HE-LTF sequence in the $2\times$ LTF design, the positions of the pilot tone positions in the even and odd RUs are mirror symmetric.

[0286] FIG. 24 includes a Table 4 that indicates pilot tone positions for six embodiments of alternative 1 of design A for 108-subcarrier RUs. The embodiments include three spacing options a, b, and c for each of two mappings (even or odd) of an HE-LTF sequence in a $2\times$ LTF design.

[0287] Table 4 includes three columns corresponding to the spacing options a, b, and c, respectively. Each column is composed of two subcolumns, i) an “EVEN/EVEN or ODD/ODD” subcolumn indicating positions in either even RUs when an even mapping of the HE-LTF is used or odd RUs when an odd mapping of the HE-LTF is used, and ii) an “ODD/EVEN or EVEN/ODD” subcolumn indicating positions in either the even RUs when the odd mapping of the HE-LTF is used or the odd RUs when the even mapping of the HE-LTF is used.

[0288] In each row, each column indicates a subcarrier position (SC) of an element (such as an edge carrier or a pilot tone) corresponding to the row and a spacing (or Gap)

between the element corresponding to the row and the element corresponding to the next row.

[0289] In each case, the edge carriers of the RU includes a lowest subcarrier (low SC) having an index of 0, and a highest subcarrier (high SC) having an index of 107.

[0290] For a first example, in an embodiment of option a of alternative 1 of design A having an even tone mapping of an HE-LTF sequence in the $2\times$ LTF design, first to sixth pilots of even RUs are respectively located at indexes of +8, +26, +44, +62, +80, and +98, respectively. First to sixth pilots of odd RUs are respectively located at indexes of +9, +27, +45, +63, +81, and +99, respectively.

[0291] In the first example, the positions of the pilot tone positions in the even and odd RUs are mirror symmetric. That is, the spacing between the pilot tone positions and edge subcarriers, starting from the lowest subcarrier, are 8, 17, 17, 17, 17, 17, and 9 in the even RUs and 9, 17, 17, 17, 17, 17, and 8 in the odd RUs.

[0292] For a second example, in an embodiment of option b of alternative 1 of design A having an odd tone mapping of an HE-LTF sequence in the $2\times$ LTF design, first to sixth pilots of even RUs are respectively located at indexes of +7, +25, +45, +61, +79, and +97, respectively. First to sixth pilots of odd RUs are respectively located at indexes of +10, +28, +46, +64, 82, and +100, respectively.

[0293] As in the first example, in the second example, the positions of the pilot tone positions in the even and odd RUs are mirror symmetric. That is, the spacing between the pilot tone positions and edge subcarriers, starting from the lowest subcarrier, are 7, 17, 17, 17, 17, 17, and 10 in the even RUs and 10, 17, 17, 17, 17, and 7 in the odd RUs.

[0294] Table 4 illustrates that in every combination of i) one of option a, b, and c, and ii) one of an even and odd tone mapping of an HE-LTF sequence in the $2\times$ LTF design, the positions of the pilot tone positions in the even and odd RUs are mirror symmetric.

[0295] FIG. 25 includes a Table 5 that indicates pilot tone positions for four embodiments of alternative 1 of design A for 242-subcarrier RUs. The embodiments include two spacing options a and b for each of two mappings (even or odd) of an HE-LTF sequence in a $2\times$ LTF design.

[0296] Table 5 includes a left set of columns for a 242-subcarrier RUs in a 20 MHz bandwidth, wherein the RU is always an even RU. In the set of columns for the 20 MHz channel bandwidth, three sub-columns correspond to pilot tone positions for option a for an even mapping of the HE-LTF, pilot tone positions for option b for the even mapping of the HE-LTF, and pilot tone positions for an odd mapping of the HE-LTF for both options a and b, respectively.

[0297] In each row on the left side, three columns indicates respective subcarrier positions (SCs) of an element (such as an edge carrier or a pilot tone) corresponding to the row for the spacing option and LTF mapping, and a fourth column indicates spacing (or Gap) between the element corresponding to the row and the element corresponding to the next row, which does not vary between the options a and b and the LTF mapping being even or odd.

[0298] Table 5 includes a right set of columns for 242-subcarrier RUs in any of a 40 MHz, an 80 MHz, or a 160 MHz channel bandwidth, wherein an RU can be an even or an odd RU. Within the right set, a column is provided for a spacing option a and a spacing option b.

[0299] In the right set of columns, Each column for spacing option a or b is composed of two subcolumns, i) an “EVEN/EVEN or ODD/ODD” subcolumn indicating positions in either even RUs when an even mapping of the HE-LTF is used or odd RUs when an odd mapping of the HE-LTF is used, and ii) an “ODD/EVEN or EVEN/ODD” subcolumn indicating positions in either the even RUs when the odd mapping of the HE-LTF is used or the odd RUs when the even mapping of the HE-LTF is used.

[0300] In each row on the right side, each column indicates a subcarrier position (SC) of an element (such as an edge carrier or a pilot tone) corresponding to the row and a spacing (or Gap) between the element corresponding to the row and the element corresponding to the next row.

[0301] In the embodiments within the 20 MHz channel bandwidth, the edge carriers of the RU includes a lowest subcarrier (low SC) having an index of -122, and a highest subcarrier (high SC) having an index of 122. In the embodiments within the 40, 80, or 160 MHz bandwidth, the edge carriers of the RUs includes a lowest subcarrier (low SC) having an index of 0, and a highest subcarrier (high SC) having an index of 241.

[0302] For a first example, in an embodiment of option a of alternative 1 of design A having an even tone mapping of an HE-LTF sequence in the $2\times$ LTF design in a 20 MHz bandwidth, first to eighth pilots of the 242-subcarrier RU are respectively located at indexes of -104, -76, -40, -12, +12, +40, +76, +104, respectively.

[0303] For a second example, in an embodiment of option b of alternative 1 of design A having an odd tone mapping of an HE-LTF sequence in the $2\times$ LTF design for a 40, 80, or 160 MHz channel bandwidth, first to eighth pilots of even RUs are respectively located at indexes of 19, 47, 83, 111, 131, 159, 195, and 223, respectively. First to eighth pilots of odd RUs are respectively located at indexes of 18, 46, 82, 110, 130, 158, 194, and 222, respectively.

[0304] In the second example, the positions of the pilot tone positions in the even and odd RUs are mirror symmetric. That is, the spacing between the pilot tone positions and edge subcarriers, starting from the lowest subcarrier, are 19, 27, 35, 27, 19, 27, 35, 27, and 18 in the even RUs and 18, 27, 35, 27, 19, 27, 35, 27, and 19 in the odd RUs.

[0305] Table 5 illustrates that, for channel bandwidths of 40, 80 and 160 MHz, in every combination of i) one of option a and b, and ii) one of an even and odd tone mapping of an HE-LTF sequence in the $2\times$ LTF design, the positions of the pilot tone positions in the even and odd RUs are mirror symmetric. In a 20 MHz channel bandwidth, there is only one 242-subcarrier RU.

[0306] FIG. 26 includes a Table 6 that indicates pilot tone positions for six embodiments of alternative 1 of design A for 242-subcarrier RUs. The embodiments include three spacing options a, b, and c for each of two mappings (even or odd) of an HE-LTF sequence in a $2\times$ LTF design.

[0307] Table 6 includes three columns corresponding to the spacing options a, b, and c, respectively. Each column is composed of two subcolumns, i) an “EVEN/EVEN or ODD/ODD” subcolumn indicating positions in either even RUs when an even mapping of the HE-LTF is used or odd RUs when an odd mapping of the HE-LTF is used, and ii) an “ODD/EVEN or EVEN/ODD” subcolumn indicating positions in either the even RUs when the odd mapping of the HE-LTF is used or the odd RUs when the even mapping of the HE-LTF is used.

[0308] In each row, each column indicates a subcarrier position (SC) of an element (such as an edge carrier or a pilot tone) corresponding to the row and a spacing (or Gap) between the element corresponding to the row and the element corresponding to the next row.

[0309] In each case, the edge carriers of the RU includes a lowest subcarrier (low SC) having an index of 0, and a highest subcarrier (high SC) having an index of 241.

[0310] For example, in an embodiment of option a of alternative 1 of design A having an even tone mapping of an HE-LTF sequence in the 2×LTF design, first to eighth pilots of even RUs are respectively located at indexes of +16, +46, +76, +106, +136, +166, +196, and +226, respectively. First to eighth pilots of odd RUs are respectively located at indexes of +15, +45, +75, +105, +135, +165, +195, and +225, respectively.

[0311] In the example, the positions of the pilot tone positions in the even and odd RUs are mirror symmetric. That is, the spacing between the pilot tone positions and edge subcarriers, starting from the lowest subcarrier, are 16, 29, 29, 29, 29, 29, 29, 29, and 15 in the even RUs and 15, 29, 29, 29, 29, 29, 29, 29, and 16 in the odd RUs.

[0312] Table 6 illustrates that in every combination of i) one of option a, b, and c, and ii) one of an even and odd tone mapping of an HE-LTF sequence in the 2×LTF design, the positions of the pilot tone positions in the even and odd RUs are mirror symmetric.

[0313] FIG. 27 includes a Table 7 that indicates pilot tone positions for six embodiments of alternative 1 of design A for center 242-subcarrier RUs. The embodiments include three spacing options a, b, and c for each of two mappings (even or odd) of an HE-LTF sequence in a 2×LTF design.

[0314] Table 6 includes three columns corresponding to the spacing options a, b, and c, respectively. Each column is composed of two subcolumns, i) an “EVEN” subcolumn indicating positions in the center RU when an even mapping of the HE-LTF is used, and ii) an “ODD” subcolumn indicating positions in the center RUs when the odd mapping of the HE-LTF is used.

[0315] In each row, each column indicates a subcarrier position of an element (such a pilot tone) corresponding to the row. The subcarrier positions that are below the center of the RU are given relative to a negative offset $-f_0$. The subcarrier positions that are above the center of the RU are given relative to a positive offset $+f_0$. The negative and positive offsets $-f_0$ and $+f_0$ correspond to the first non-DC subcarriers below and above the center of the RU respectively, and the values of the negative and positive offsets $-f_0$ and $+f_0$ are determined by a number of DC subcarriers at the center of the RU.

[0316] In the embodiments shown in Table 7, pilot within each of an upper and lower half of the center RU are separated by 29 tones.

[0317] Table 7 illustrates that in every combination of i) one of option a, b, and c, and ii) one of an even and odd tone mapping of an HE-LTF sequence in the 2×LTF design, the positions of the pilot tone positions below and above the center of the center RU are mirror symmetric.

5. Design A, Alternative 2: Pilot can be Mapped to Null LTF Tones

[0318] FIG. 28 illustrates pilot tone positions for an even RU block 2800 with 26 subcarriers when an even tone mapping of an LTF sequence in a 2×LTF design is used, or

for an odd RU block 2800 with 26 subcarriers and when an odd tone mapping of the LTF sequence in the 2×LTF design is used, according to an embodiment of alternative 2 of design A. FIG. 29 illustrates pilot tone positions for an odd RU block 2900 with 26 subcarriers when an even tone mapping of the LTF sequence in the 2×LTF design is used, or for an even RU block 2900 with 26 subcarriers when an odd tone mapping of the LTF sequence in the 2×LTF design is used, according to an embodiment of alternative 2 of design A.

[0319] Locations of tones in the RU blocks 2800 and 2900 are given relative to an offset f_0 within a 20 MHz channel. The offset f_0 can be any of -122 , -95 , -68 , -41 , $+16$, $+43$, $+70$, and $+97$.

[0320] Alternative 2 defines the tone spacing between the pilots (that is, between first and second pilots 2804 and 2806 of the RU block 2800 and between first and second pilots 2904 and 2906 of the RU block 2900) to be 12 subcarriers and includes 6 subcarriers between outer edges of the RU and respective nearest pilot tone positions. In the 2×LTF design, the LTF OFDM symbol will only carry one pilot within the 26 subcarrier RU (because the LTF tones of the 2×LTF design, indicated by upward pointing arrows, only coincide with one pilot tone position in each of the RU blocks 2800 and 2900), however for the 4×LTF design, the LTF OFDM symbol will carry two pilots within the 26 subcarrier RU.

[0321] FIG. 30 illustrates pilot tone positions for a center RU block 3000 with 26 subcarriers when odd tone mapping of an LTF sequence in a 2×LTF design are used. Locations of tones in the center RU block 3000 are given relative to a first offset f_0 and a second offset f_1 relative to a center subcarrier of the center RU block 3000. The first, second, and third embodiment, the first offset f_0 can respectively be -14 , -15 , and -16 and the second offset f_1 can respectively be $+2$, $+3$, and $+4$. Tones that are lower than the center subcarrier of the center RU block 3000 have position indicated relative to the first offset f_0 . Tones that are higher than the center subcarrier of the center RU block 3000 have position indicated relative to the second offset f_1 .

[0322] Alternative 2 defines the tone spacing between the first and second pilots 3004 and 3006 to be 12 subcarriers (not including any of the DC subcarriers 3002) and 6 subcarriers to the outer edge of the RU from pilot tone positions. This results in no pilots to be carried in the central 26 subcarrier RU of the LTF OFDM symbol in case of 2×LTF design because the LTF tones of the 2×LTF design, indicated by upward pointing arrows, do not correspond with either of the first pilot tone position 3004 and the second pilot tone position 3006.

[0323] FIG. 31 illustrates pilot tone positions for an even RU block 3100 with 52 subcarriers when an even tone mapping of an LTF sequence in a 2×LTF design is used, or for an odd RU block 3100 with 52 subcarriers and when an odd tone mapping of the LTF sequence in the 2×LTF design is used, according to an embodiment of alternative 2 of design A. FIG. 32 illustrates pilot tone positions for an odd RU block 3200 with 56 subcarriers when the even tone mapping of the LTF sequence in the 2×LTF design is used, or for an even RU block 3100 with 26 subcarriers when the odd tone mapping of the LTF sequence in the 2×LTF design is used, according to an embodiment of alternative 2 of design A.

[0324] Alternative 2 defines the tone spacing between the any two pilots to be 12 subcarriers and 6 subcarriers to the outer edge of the RU from pilot tone positions. Accordingly, RU Block **3100** has first, second, third, and fourth pilots **3104**, **3106**, **3108**, and **3110** at locations 6, 19, 32, and 45, respectively, and RU Block **3200** has first, second, third, and fourth pilots **3204**, **3206**, **3208**, and **3210** at locations 6, 19, 32, and 45, respectively.

[0325] When the 2×LTF design is used, the LTF OFDM symbol will only carry two pilots within the 52 subcarrier RU, as shown in FIGS. **31** and **32** by only two of the pilot tone positions coinciding with the positions (indicated by upward pointing arrows) of tones in the 2×LTF design. For the 4×LTF design, the LTF OFDM symbol will carry four pilots within the 52 subcarrier RU.

6. Design B: Nested Pilot Structure

[0326] In a nested pilot structure, the pilot tone positions between different RUs having different number of subcarriers share the same physical frequency position. One or more pilot tone positions for a smallest resource size unit is determined, and pilot tone positions of a larger resource size unit are chosen from among the pilot tone positions of the smallest resource size unit. Embodiment of pilot tone position design are disclosed herein for two different cases.

[0327] Case 1 embodies RU definition design with 26 subcarrier RUs, 52 subcarriers RUs, 106 or 108 subcarrier RUs, 242 subcarrier RUs, 484 subcarrier RUs, and 994 or 996 subcarrier RUs, wherein there are one or more null or reserved tones between each 26 subcarrier RU and any adjacent 26 subcarrier RUs. Case 2 embodies RU definition design with 26 subcarrier RUs, 52 subcarriers RUs, 106 or 108 subcarrier RUs, 242 subcarrier RUs, 484 subcarrier RUs, and 994 or 996 subcarrier RUs, wherein pairs of consecutive 26 subcarrier RUs line up (frequency wise) with 52 subcarrier RUs, except for the central 26 subcarrier RU within each 20 MHz bandwidth.

[0328] In FIGS. **33** to **45**, potential pilot tone positions in a 20 MHz bandwidth are indicated by dotted lines extending vertically through the figures. Actual pilot tone positions for each RU are indicated by upward pointing arrows. A solid upward pointing arrow indicates a pilot tone position with a fixed position. A dashed upward pointing arrow indicates a pilot tone position having one of two positions, includes a first position to the left of a reference subcarrier and a second position to the right of a reference subcarrier, according to a design choice. In an embodiment, the reference subcarriers are center subcarriers of 13-subcarrier halves of 26-subcarrier RUs.

[0329] In one embodiment, each potential pilot tone position aligns with a pilot tone position in an HE-LTF symbol of the frame. In some embodiments, two pilot tone positions are present in each 26 subcarrier RU for a given bandwidth. For example, as shown in FIGS. **12**, **13**, and **16**, the pilot tone positions in each 26 subcarrier RU may be represented by the tones **1204** and **1206** (in relation to FIG. **12**), tones **1304** and **1306** (in relation to FIG. **13**), and tones **1604** and **1606** (in relation to FIG. **16**). The pilot tone positions in 26 subcarrier RUs become the potential pilot tone positions for RUs with greater number of subcarriers (e.g., 52, 106, 242, 484, 996, and 2×996 subcarriers). In other word, the potential pilot tone positions are aggregation of pilot tone positions used for each 26 subcarrier RU for a given bandwidth.

[0330] FIG. **33A** illustrates a first option for pilot tone positions of a 20 MHz channel **3300** in Case 1. In Case 1, at least one null or reserved tone is present between each 26-subcarrier RU. Pilot tone positions for each RU are selected from first to eighteenth potential pilot tone positions c1 to c18. FIG. **33B** shows Table 9, which lists the positions of each of the potential pilot tone positions c1 to c18 according to an embodiment, but embodiments are not limited thereto, and any of the pilot tone positions disclosed for 26-subchannel RUs in Design A, above, may be used for the potential pilot tone positions c1 to c18. FIGS. **33A** and **33B** show that the 20 MHz channel **3300** has a total number of potential pilot tone positions of 18.

[0331] In FIG. **33A** and in FIGS. **34** to **25**, numbers appearing immediately below each RU indicate indices of lowest and highest subcarriers of the RU. The indices are relative to a central (0^{th}) DC subcarrier of the 20 MHz channel **3300**. For example, in FIG. **33A**, the numbers appearing directly below a first 26-subcarrier RU **3302** indicates that the index of a lowest subcarrier of the first 26-subcarrier RU **3302** is -122 and that the index of a highest subcarrier of the first 26-subcarrier RU **3302** is -97 . The positions shown in Table 33B are also relative to the central (0^{th}) DC subcarrier of the 20 MHz channel **3300**.

[0332] FIG. **33A** shows a first 26-subcarrier RU **3302** having pilot tone positions at potential pilot tone positions c1 and c2, a second 26-subcarrier RU **3304** having pilot tone positions at potential pilot tone positions c3 and c4, a third 26-subcarrier RU **3306** having pilot tone positions at potential pilot tone positions c5 and c6, a fourth 26-subcarrier RU **3308** having pilot tone positions at potential pilot tone positions c7 and c8, a fifth (center) 26-subcarrier RU **3310** having pilot tone positions at potential pilot tone positions c9 and c10, a sixth 26-subcarrier RU **3312** having pilot tone positions at potential pilot tone positions c11 and c12, a seventh 26-subcarrier RU **3314** having pilot tone positions at potential pilot tone positions c13 and c14, an eighth 26-subcarrier RU **3316** having pilot tone positions at potential pilot tone positions c15 and c16, and a ninth 26-subcarrier RU **3318** having pilot tone positions at potential pilot tone positions c17 and c18.

[0333] FIG. **33A** further shows a first 52-subcarrier RU **3322** having pilot tone positions at potential pilot tone positions c1, c2, c3, and c4, a second 52-subcarrier RU **3324** having pilot tone positions at potential pilot tone positions c5, c6, c7, and c8, a third 52-subcarrier RU **3326** having pilot tone positions at potential pilot tone positions c11, c12, c13, and c14, and a fourth 52-subcarrier RU **3328** having pilot tone positions at potential pilot tone positions c15, c16, c17, and c18.

[0334] FIG. **33A** further shows a first 106-subcarrier RU **3332** having pilot tone positions at potential pilot tone positions c1, c4, c5, and c8, a second 106-subcarrier RU **3334** having pilot tone positions at potential pilot tone positions c11, c14, c15, and c18, and a 242-subcarrier RU **3336** having pilot tone positions at potential pilot tone positions c1, c4, c5, c8, c11, c14, c15, and c18.

[0335] Each of the 52-, 106-, and 242-subcarrier RUs in FIG. **33A** has pilot tone positions selected from among the pilot tone positions used by the RUs having fewer subcarriers that occupy the same bandwidth.

[0336] Furthermore, each RU in a lower 10 MHz of the 20 MHz channel **3300** has pilot tone positions that are mirror symmetric with a corresponding mirrored RU (that is, an RU

with a same number of subcarriers and a same offset from the center of the 20 MHz channel **3300**) of an upper 10 MHz of the 20 MHz channel **3300**. For example, the pilot tone positions of the first 26-subcarrier RU **3302** are positioned to be mirror-symmetric to the pilot tone positions of the ninth 26-subcarrier RU **3318**, the pilot tone positions of the second 52-subcarrier RU **3324** are positioned to be mirror-symmetric to the pilot tone positions of the third 52-subcarrier RU **3326**, and so on.

[0337] FIG. **34** illustrates a second option for pilot tone positions in Case 1. In an embodiment, the second option may use the first to eighteenth potential pilot tone positions c_1 to c_{18} as shown in Table 9 of FIG. **33B**, but embodiments are not limited thereto, and any of the pilot tone positions disclosed for 26-subchannel RUs in Design A, above, may be used for the potential pilot tone positions c_1 to c_{18} .

[0338] FIG. **34** shows a first, second, third, and fourth 26-subcarrier RUs **3402**, **3404**, **3406**, and **3408** having pilot tone positions at potential pilot tone positions c_1 and c_2 , c_3 and c_4 , c_5 and c_6 , and c_7 and c_8 , respectively, a fifth (center) 26-subcarrier RUs **3410** having pilot tone positions at potential pilot tone positions c_9 and c_{10} , and sixth, seventh, eighth, and ninth 26-subcarrier RUs **3412**, **3414**, **3416**, and **3418** having pilot tone positions at potential pilot tone positions c_{11} and c_{12} , c_{13} and c_{14} , c_{15} and c_{16} , and c_{17} and c_{18} , respectively. In each of the 26-subcarrier RUs **3402**, **3404**, **3406**, **3408**, **3410**, **3412**, **3414**, **3416**, and **3418**, respective first and second pilot tone positions correspond to potential pilot tone positions covered by the respective 26 subcarriers.

[0339] FIG. **34** further shows a first, second, third, and fourth 52-subcarrier RUs **3422**, **3424**, **3426**, and **3428** having pilot tone positions at potential pilot tone positions c_1 , c_2 , c_3 , and c_4 , potential pilot tone positions c_5 , c_6 , c_7 , and c_8 , potential pilot tone positions c_{11} , c_{12} , c_{13} , and c_{14} , and potential pilot tone positions c_{15} , c_{16} , c_{17} , and c_{18} , respectively. In each of the 52-subcarrier RUs **3422**, **3424**, **3426**, and **3428**, respective first, second, third, and fourth pilot tone positions correspond to potential pilot tone positions covered by the respective 52 subcarriers.

[0340] FIG. **34** further shows a first 106-subcarrier RU **3432** having pilot tone positions at potential pilot tone positions c_1 , c_3 , c_6 , and c_8 , a second 106-subcarrier RU **3434** having pilot tone positions at potential pilot tone positions c_{11} , c_{13} , c_{16} , and c_{18} . In each of the 106-subcarrier RUs **3433** and **3434**, a first pilot tone position has an index corresponding to a lowest index among potential pilot tone positions covered by the RU, a second pilot tone position is spaced two potential pilot tone positions away from the first pilot tone position, a third pilot tone position spaced three potential pilot tone positions away from the second pilot tone position, and a fourth pilot tone position spaced two potential pilot tone positions away from the third pilot tone position.

[0341] FIG. **34** further shows a 242-subcarrier RU **3436** having pilot tone positions at potential pilot tone positions c_1 , c_3 , c_6 , c_8 , c_{11} , c_{13} , c_{16} , and c_{18} . The 242-subcarrier RU **3436** has a first pilot tone position having a lowest index among potential pilot tone positions covered by the 242 subcarriers, a second pilot tone position spaced two potential pilot tone positions away from the first pilot tone position, a third pilot tone position spaced three potential pilot tone positions away from the second pilot tone position, a fourth pilot tone position spaced two potential pilot tone positions

away from the third pilot tone position, a fifth pilot tone position spaced three potential pilot tone positions away from the fourth pilot tone position, a sixth pilot tone position spaced two potential pilot tone positions away from the fifth pilot tone position, a seventh pilot tone position spaced three potential pilot tone positions away from the sixth pilot tone position, and an eighth pilot tone position spaced two potential pilot tone positions away from the seventh pilot tone position.

[0342] Each of the 52-, 106-, and 242-subcarrier RUs in FIG. **34** has pilot tone positions selected from among the pilot tone positions used by the RUs having fewer subcarriers that occupy the same bandwidth. Further, the pilot tone positions shown in FIG. **34** illustrates the mirror symmetry described with respect to FIG. **33A**. Therefore, pilot tone positions meet the following relationship: $c_1 = -c_{18}$, $c_2 = -c_{17}$, $c_3 = -c_{16}$, $c_4 = -c_{15}$, $c_5 = -c_{14}$, $c_6 = -c_{13}$, $c_7 = -c_{12}$, $c_8 = -c_{11}$, and $c_9 = -c_{10}$ ($c_{18} > c_{17} > c_{16} > c_{15} > c_{14} > c_{13} > c_{12} > c_{11} > c_{10} > c_9 > c_8 > c_7 > c_6 > c_5 > c_4 > c_3 > c_2 > c_1$).

[0343] FIG. **35** illustrates a third option for pilot tone positions in Case 1. In an embodiment, the third option may use the first to eighteenth potential pilot tone positions c_1 to c_{18} as shown in Table 9 of FIG. **33B**, but embodiments are not limited thereto, and any of the pilot tone positions disclosed for 26-subchannel RUs in Design A, above, may be used for the potential pilot tone positions c_1 to c_{18} .

[0344] FIG. **35** shows a first, second, third, and fourth 26-subcarrier RU **3502**, **3504**, **3506**, and **3508** having pilot tone positions at potential pilot tone positions c_1 and c_2 , c_3 and c_4 , c_5 and c_6 , and c_7 and c_8 , respectively, a fifth (center) 26-subcarrier RU **3510** having pilot tone positions at potential pilot tone positions c_9 and c_{10} , and sixth, seventh, eighth, and ninth 26-subcarrier RU **3512**, **3514**, **3516**, and **3518** having pilot tone positions at potential pilot tone positions c_{11} and c_{12} , c_{13} and c_{14} , c_{15} and c_{16} , and c_{17} and c_{18} , respectively.

[0345] FIG. **35** further shows a first, second, third, and fourth 52-subcarrier RU **3522**, **3524**, **3526**, and **3528** having pilot tone positions at potential pilot tone positions c_1 , c_2 , c_3 , and c_4 , potential pilot tone positions c_5 , c_6 , c_7 , and c_8 , potential pilot tone positions c_{11} , c_{12} , c_{13} , and c_{14} , and potential pilot tone positions c_{15} , c_{16} , c_{17} , and c_{18} , respectively.

[0346] FIG. **35** further shows a first 106-subcarrier RU **3532** having pilot tone positions at potential pilot tone positions c_1 , c_3 , c_5 , and c_7 , a second 106-subcarrier RU **3534** having pilot tone positions at potential pilot tone positions c_{12} , c_{14} , c_{16} , and c_{18} , and a 242-subcarrier RU **3536** having pilot tone positions at potential pilot tone positions c_1 , c_3 , c_5 , c_7 , c_{12} , c_{14} , c_{16} , and c_{18} .

[0347] Each of the 52-, 106-, and 242-subcarrier RUs in FIG. **35** has pilot tone positions selected from among the pilot tone positions used by the RUs having fewer subcarriers that occupy the same bandwidth. Further, the pilot tone positions shown in FIG. **35** illustrates the mirror symmetry described with respect to FIG. **33A**.

[0348] FIG. **36** illustrates a fourth option for pilot tone positions in Case 1. In an embodiment, the fourth option may use the first to eighteenth potential pilot tone positions c_1 to c_{18} as shown in Table 9 of FIG. **33B**, but embodiments are not limited thereto.

[0349] FIG. **36** shows a first, second, third, and fourth 26-subcarrier RU **3602**, **3604**, **3606**, and **3608** having pilot tone positions at potential pilot tone positions c_1 and c_2 , c_3

and c4, c5 and c6, and c7 and c8, respectively, a fifth (center) 26-subcarrier RU **3610** having pilot tone positions at potential pilot tone positions c9 and c10, and sixth, seventh, eighth, and ninth 26-subcarrier RU **3612**, **3614**, **3616**, and **3618** having pilot tone positions at potential pilot tone positions c11 and c12, c13 and c14, c15 and c16, and c17 and c18, respectively.

[0350] FIG. 36 further shows a first, second, third, and fourth 52-subcarrier RU **3622**, **3624**, **3626**, and **3628** having pilot tone positions at potential pilot tone positions c1, c2, c3, and c4, potential pilot tone positions c5, c6, c7, and c8, potential pilot tone positions c11, c12, c13, and c14, and potential pilot tone positions c15, c16, c17, and c18, respectively.

[0351] FIG. 36 further shows a first 106-subcarrier RU **3632** having pilot tone positions at potential pilot tone positions c2, c4, c6, and c8, a second 106-subcarrier RU **3634** having pilot tone positions at potential pilot tone positions c11, c13, c15, and c17, and a 242-subcarrier RU **3636** having pilot tone positions at potential pilot tone positions c2, c4, c6, c8, c11, c13, c15, and c17.

[0352] Each of the 52-, 106-, and 242-subcarrier RUs in FIG. 36 has pilot tone positions selected from among the pilot tone positions used by the RUs having fewer subcarriers that occupy the same bandwidth. Further, the pilot tone positions shown in FIG. 36 illustrates the mirror symmetry described with respect to FIG. 33A.

[0353] The options 1, 2, 3, and 4 of Case 1 shown in FIGS. 33A, 34, 35, and 36, respectively illustrate pilot tone positions for a 20 MHz bandwidth and when 106 subcarrier RUs are used instead of 108 subcarrier RUs. The pilot tone positions within the 26 subcarrier RU can be the suggested pilot tone positions embodiments described in the Design A section.

[0354] Resource Units (RUs) with larger sizes will have pilot tone positions that are the same as or a subset of the pilot tone positions for aggregated 26-subcarrier RUs occupying the same frequencies. The 106-subcarrier RUs have 4 pilots within its RU allocation from among the eight potential pilot tone positions available for the 106-subcarrier RU. The options 1 to 4 are different alternatives for the four pilot tone positions of the 106-subcarrier RUs and corresponding eight pilot tone positions of a 242-subcarrier RU. The pilot tone positions for 106 subcarrier RU and 242 subcarrier RU are chosen from the set of potential positions stemming from the pilot tone positions of the 26 subcarrier RUs such that frequency diversity can be maximized (that is, so that the spacing between the pilots are large).

[0355] FIG. 37 illustrates a fifth option for pilot tone positions in Case 1. In an embodiment, the fifth option may use the first to eighteenth potential pilot tone positions c1 to c18 as shown in Table 9 of FIG. 33B, but embodiments are not limited thereto.

[0356] FIG. 37 shows a first, second, third, and fourth 26-subcarrier RU **3702**, **3704**, **3706**, and **3708** having pilot tone positions at potential pilot tone positions c1 and c2, c3 and c4, c5 and c6, and c7 and c8, respectively, a fifth (center) 26-subcarrier RU **3710** having pilot tone positions at potential pilot tone positions c9 and c10, and sixth, seventh, eighth, and ninth 26-subcarrier RU **3712**, **3714**, **3716**, and **3718** having pilot tone positions at potential pilot tone positions c11 and c12, c13 and c14, c15 and c16, and c17 and c18, respectively.

[0357] FIG. 37 further shows a first, second, third, and fourth 52-subcarrier RU **3722**, **3724**, **3726**, and **3728** having pilot tone positions at potential pilot tone positions c1, c2, c3, and c4, potential pilot tone positions c5, c6, c7, and c8, potential pilot tone positions c11, c12, c13, and c14, and potential pilot tone positions c15, c16, c17, and c18, respectively.

[0358] FIG. 37 further shows a first 108-subcarrier RU **3732** having pilot tone positions at potential pilot tone positions c1, c2, c4, c5, c7, and c8, a second 108-subcarrier RU **3734** having pilot tone positions at potential pilot tone positions c11, c12, c14, c15, c17, and c18, and a 242-subcarrier RU **3736** having pilot tone positions at potential pilot tone positions c1, c4, c5, c8, c11, c14, c15, and c18.

[0359] Each of the 52-, 108-, and 242-subcarrier RUs in FIG. 37 has pilot tone positions selected from among the pilot tone positions used by the RUs having fewer subcarriers that occupy the same bandwidth. Further, the pilot tone positions shown in FIG. 37 illustrates the mirror symmetry described with respect to FIG. 33A.

[0360] FIG. 38 illustrates a sixth option for pilot tone positions in Case 1. In an embodiment, the sixth option may use the first to eighteenth potential pilot tone positions c1 to c18 as shown in Table 9 of FIG. 33B, but embodiments are not limited thereto.

[0361] FIG. 38 shows a first, second, third, and fourth 26-subcarrier RU **3802**, **3804**, **3806**, and **3808** having pilot tone positions at potential pilot tone positions c1 and c2, c3 and c4, c5 and c6, and c7 and c8, respectively, a fifth (center) 26-subcarrier RU **3810** having pilot tone positions at potential pilot tone positions c9 and c10, and sixth, seventh, eighth, and ninth 26-subcarrier RU **3812**, **3814**, **3816**, and **3818** having pilot tone positions at potential pilot tone positions c11 and c12, c13 and c14, c15 and c16, and c17 and c18, respectively.

[0362] FIG. 38 further shows a first, second, third, and fourth 52-subcarrier RU **3822**, **3824**, **3826**, and **3828** having pilot tone positions at potential pilot tone positions c1, c2, c3, and c4, potential pilot tone positions c5, c6, c7, and c8, potential pilot tone positions c11, c12, c13, and c14, and potential pilot tone positions c15, c16, c17, and c18, respectively.

[0363] FIG. 38 further shows a first 108-subcarrier RU **3832** having pilot tone positions at potential pilot tone positions c1, c2, c4, c5, c7, and c8, a second 108-subcarrier RU **3834** having pilot tone positions at potential pilot tone positions c11, c12, c14, c15, c17, and c18, and a 242-subcarrier RU **3836** having pilot tone positions at potential pilot tone positions c1, c4, c7, c8, c11, c12, c15, and c18.

[0364] Each of the 52-, 108-, and 242-subcarrier RUs in FIG. 38 has pilot tone positions selected from among the pilot tone positions used by the RUs having fewer subcarriers that occupy the same bandwidth. Further, the pilot tone positions shown in FIG. 38 illustrates the mirror symmetry described with respect to FIG. 33A.

[0365] FIG. 39 illustrates a seventh option for pilot tone positions in Case 1. In an embodiment, the seventh option may use the first to eighteenth potential pilot tone positions c1 to c18 as shown in Table 9 of FIG. 33B, but embodiments are not limited thereto.

[0366] FIG. 39 shows a first, second, third, and fourth 26-subcarrier RU **3902**, **3904**, **3906**, and **3908** having pilot tone positions at potential pilot tone positions c1 and c2, c3 and c4, c5 and c6, and c7 and c8, respectively, a fifth (center)

26-subcarrier RU **3910** having pilot tone positions at potential pilot tone positions c9 and c10, and sixth, seventh, eighth, and ninth 26-subcarrier RU **3912**, **3914**, **3916**, and **3918** having pilot tone positions at potential pilot tone positions c11 and c12, c13 and c14, c15 and c16, and c17 and c18, respectively.

[0367] FIG. 39 further shows a first, second, third, and fourth 52-subcarrier RU **3922**, **3924**, **3926**, and **3928** having pilot tone positions at potential pilot tone positions c1, c2, c3, and c4, potential pilot tone positions c5, c6, c7, and c8, potential pilot tone positions c11, c12, c13, and c14, and potential pilot tone positions c15, c16, c17, and c18, respectively.

[0368] FIG. 39 further shows a first 108-subcarrier RU **3932** having pilot tone positions at potential pilot tone positions c1, c2, c4, c5, c7, and c8, a second 108-subcarrier RU **3934** having pilot tone positions at potential pilot tone positions c11, c12, c14, c15, c17, and c18, and a 242-subcarrier RU **3936** having pilot tone positions at potential pilot tone positions c1, c2, c5, c8, c11, c14, c17, and c18.

[0369] Each of the 52-, 108-, and 242-subcarrier RUs in FIG. 39 has pilot tone positions selected from among the pilot tone positions used by the RUs having fewer subcarriers that occupy the same bandwidth. Further, the pilot tone positions shown in FIG. 39 illustrates the mirror symmetry described with respect to FIG. 33A.

[0370] FIG. 40 illustrates an eighth option for pilot tone positions in Case 1. In an embodiment, the eighth option may use the first to eighteenth potential pilot tone positions c1 to c18 as shown in Table 9 of FIG. 33B, but embodiments are not limited thereto.

[0371] FIG. 40 shows a first, second, third, and fourth 26-subcarrier RU **4002**, **4004**, **4006**, and **4008** having pilot tone positions at potential pilot tone positions c1 and c2, c3 and c4, c5 and c6, and c7 and c8, respectively, a fifth (center) 26-subcarrier RU **4010** having pilot tone positions at potential pilot tone positions c9 and c10, and sixth, seventh, eighth, and ninth 26-subcarrier RU **4012**, **4014**, **4016**, and **4018** having pilot tone positions at potential pilot tone positions c11 and c12, c13 and c14, c15 and c16, and c17 and c18, respectively.

[0372] FIG. 40 further shows a first, second, third, and fourth 52-subcarrier RU **4022**, **4024**, **4026**, and **4028** having pilot tone positions at potential pilot tone positions c1, c2, c3, and c4, potential pilot tone positions c5, c6, c7, and c8, potential pilot tone positions c11, c12, c13, and c14, and potential pilot tone positions c15, c16, c17, and c18, respectively.

[0373] FIG. 40 further shows a first 108-subcarrier RU **4032** having pilot tone positions at potential pilot tone positions c1, c3, c4, c5, c6, and c8, a second 108-subcarrier RU **4034** having pilot tone positions at potential pilot tone positions c11, c13, c14, c15, c16, and c18, and a 242-subcarrier RU **4036** having pilot tone positions at potential pilot tone positions c1, c4, c5, c8, c11, c14, c15, and c18.

[0374] Each of the 52-, 108-, and 242-subcarrier RUs in FIG. 40 has pilot tone positions selected from among the pilot tone positions used by the RUs having fewer subcarriers that occupy the same bandwidth. Further, the pilot tone positions shown in FIG. 40 illustrates the mirror symmetry described with respect to FIG. 33A.

[0375] FIG. 41 illustrates a ninth option for pilot tone positions in Case 1. In an embodiment, the ninth option may

use the first to eighteenth potential pilot tone positions c1 to c18 as shown in Table 9 of FIG. 33B, but embodiments are not limited thereto.

[0376] FIG. 41 shows a first, second, third, and fourth 26-subcarrier RU **4102**, **4104**, **4106**, and **4108** having pilot tone positions at potential pilot tone positions c1 and c2, c3 and c4, c5 and c6, and c7 and c8, respectively, a fifth (center) 26-subcarrier RU **4110** having pilot tone positions at potential pilot tone positions c9 and c10, and sixth, seventh, eighth, and ninth 26-subcarrier RU **4112**, **4114**, **4116**, and **4118** having pilot tone positions at potential pilot tone positions c11 and c12, c13 and c14, c15 and c16, and c17 and c18, respectively.

[0377] FIG. 41 further shows a first, second, third, and fourth 52-subcarrier RU **4122**, **4124**, **4126**, and **4128** having pilot tone positions at potential pilot tone positions c1, c2, c3, and c4, potential pilot tone positions c5, c6, c7, and c8, potential pilot tone positions c11, c12, c13, and c14, and potential pilot tone positions c15, c16, c17, and c18, respectively.

[0378] FIG. 41 further shows a first 108-subcarrier RU **4132** having pilot tone positions at potential pilot tone positions c1, c3, c4, c5, c6, and c8, a second 108-subcarrier RU **4134** having pilot tone positions at potential pilot tone positions c11, c13, c14, c15, c16, and c18, and a 242-subcarrier RU **4136** having pilot tone positions at potential pilot tone positions c1, c3, c6, c8, c11, c13, c16, and c18.

[0379] Each of the 52-, 108-, and 242-subcarrier RUs in FIG. 41 has pilot tone positions selected from among the pilot tone positions used by the RUs having fewer subcarriers that occupy the same bandwidth. Further, the pilot tone positions shown in FIG. 41 illustrates the mirror symmetry described with respect to FIG. 33A.

[0380] FIG. 42 illustrates a tenth option for pilot tone positions in Case 1. In an embodiment, the tenth option may use the first to eighteenth potential pilot tone positions c1 to c18 as shown in Table 9 of FIG. 33B, but embodiments are not limited thereto.

[0381] FIG. 42 shows a first, second, third, and fourth 26-subcarrier RU **4202**, **4204**, **4206**, and **4208** having pilot tone positions at potential pilot tone positions c1 and c2, c3 and c4, c5 and c6, and c7 and c8, respectively, a fifth (center) 26-subcarrier RU **4210** having pilot tone positions at potential pilot tone positions c9 and c10, and sixth, seventh, eighth, and ninth 26-subcarrier RU **4212**, **4214**, **4216**, and **4218** having pilot tone positions at potential pilot tone positions c11 and c12, c13 and c14, c15 and c16, and c17 and c18, respectively.

[0382] FIG. 42 further shows a first, second, third, and fourth 52-subcarrier RU **4222**, **4224**, **4226**, and **4228** having pilot tone positions at potential pilot tone positions c1, c2, c3, and c4, potential pilot tone positions c5, c6, c7, and c8, potential pilot tone positions c11, c12, c13, and c14, and potential pilot tone positions c15, c16, c17, and c18, respectively.

[0383] FIG. 42 further shows a first 108-subcarrier RU **4232** having pilot tone positions at potential pilot tone positions c1, c3, c4, c5, c6, and c8, a second 108-subcarrier RU **4234** having pilot tone positions at potential pilot tone positions c11, c13, c14, c15, c16, and c18, and a 242-subcarrier RU **4236** having pilot tone positions at potential pilot tone positions c1, c3, c5, c8, c11, c14, c16, and c18.

[0384] Each of the 52-, 108-, and 242-subcarrier RUs in FIG. 42 has pilot tone positions selected from among the

pilot tone positions used by the RUs having fewer subcarriers that occupy the same bandwidth. Further, the pilot tone positions shown in FIG. 42 illustrates the mirror symmetry described with respect to FIG. 33A.

[0385] FIG. 43 illustrates an eleventh option for pilot tone positions in Case 1. In an embodiment, the eleventh option may use the first to eighteenth potential pilot tone positions c1 to c18 as shown in Table 9 of FIG. 33B, but embodiments are not limited thereto.

[0386] FIG. 43 shows a first, second, third, and fourth 26-subcarrier RU 4302, 4304, 4306, and 4308 having pilot tone positions at potential pilot tone positions c1 and c2, c3 and c4, c5 and c6, and c7 and c8, respectively, a fifth (center) 26-subcarrier RU 4310 having pilot tone positions at potential pilot tone positions c9 and c10, and sixth, seventh, eighth, and ninth 26-subcarrier RU 4312, 4314, 4316, and 4318 having pilot tone positions at potential pilot tone positions c11 and c12, c13 and c14, c15 and c16, and c17 and c18, respectively.

[0387] FIG. 43 further shows a first, second, third, and fourth 52-subcarrier RU 4322, 4324, 4326, and 4328 having pilot tone positions at potential pilot tone positions c1, c2, c3, and c4, potential pilot tone positions c5, c6, c7, and c8, potential pilot tone positions c11, c12, c13, and c14, and potential pilot tone positions c15, c16, c17, and c18, respectively.

[0388] FIG. 43 further shows a first 108-subcarrier RU 4332 having pilot tone positions at potential pilot tone positions c1, c3, c4, c5, c6, and c8, a second 108-subcarrier RU 4334 having pilot tone positions at potential pilot tone positions c11, c13, c14, c15, c16, and c18, and a 242-subcarrier RU 4336 having pilot tone positions at potential pilot tone positions c1, c4, c6, c8, c11, c13, c15, and c18.

[0389] Each of the 52-, 108-, and 242-subcarrier RUs in FIG. 43 has pilot tone positions selected from among the pilot tone positions used by the RUs having fewer subcarriers that occupy the same bandwidth. Further, the pilot tone positions shown in FIG. 43 illustrates the mirror symmetry described with respect to FIG. 33A.

[0390] FIG. 44 illustrates a twelfth option for pilot tone positions in Case 1. In an embodiment, the twelfth option may use the first to eighteenth potential pilot tone positions c1 to c18 as shown in Table 9 of FIG. 33B, but embodiments are not limited thereto.

[0391] FIG. 44 shows a first, second, third, and fourth 26-subcarrier RU 4402, 4404, 4406, and 4408 having pilot tone positions at potential pilot tone positions c1 and c2, c3 and c4, c5 and c6, and c7 and c8, respectively, a fifth (center) 26-subcarrier RU 4410 having pilot tone positions at potential pilot tone positions c9 and c10, and sixth, seventh, eighth, and ninth 26-subcarrier RU 4412, 4414, 4416, and 4418 having pilot tone positions at potential pilot tone positions c11 and c12, c13 and c14, c15 and c16, and c17 and c18, respectively.

[0392] FIG. 44 further shows a first, second, third, and fourth 52-subcarrier RU 4422, 4424, 4426, and 4428 having pilot tone positions at potential pilot tone positions c1, c2, c3, and c4, potential pilot tone positions c5, c6, c7, and c8, potential pilot tone positions c11, c12, c13, and c14, and potential pilot tone positions c15, c16, c17, and c18, respectively.

[0393] FIG. 44 further shows a first 108-subcarrier RU 4432 having pilot tone positions at potential pilot tone positions c1, c2, c3, c6, c7, and c8, a second 108-subcarrier

RU 4434 having pilot tone positions at potential pilot tone positions c11, c12, c13, c16, c17, and c18, and a 242-subcarrier RU 4436 having pilot tone positions at potential pilot tone positions c1, c3, c6, c8, c11, c13, c16, and c18.

[0394] Each of the 52-, 108-, and 242-subcarrier RUs in FIG. 44 has pilot tone positions selected from among the pilot tone positions used by the RUs having fewer subcarriers that occupy the same bandwidth. Further, the pilot tone positions shown in FIG. 44 illustrates the mirror symmetry described with respect to FIG. 33A.

[0395] FIG. 45 illustrates a thirteenth option for pilot tone positions in Case 1. In an embodiment, the thirteenth option may use the first to eighteenth potential pilot tone positions c1 to c18 as shown in Table 9 of FIG. 33B, but embodiments are not limited thereto.

[0396] FIG. 45 shows a first, second, third, and fourth 26-subcarrier RU 4502, 4504, 4506, and 4508 having pilot tone positions at potential pilot tone positions c1 and c2, c3 and c4, c5 and c6, and c7 and c8, respectively, a fifth (center) 26-subcarrier RU 4510 having pilot tone positions at potential pilot tone positions c9 and c10, and sixth, seventh, eighth, and ninth 26-subcarrier RU 4512, 4514, 4516, and 4518 having pilot tone positions at potential pilot tone positions c11 and c12, c13 and c14, c15 and c16, and c17 and c18, respectively.

[0397] FIG. 45 further shows a first, second, third, and fourth 52-subcarrier RU 4522, 4524, 4526, and 4528 having pilot tone positions at potential pilot tone positions c1, c2, c3, and c4, potential pilot tone positions c5, c6, c7, and c8, potential pilot tone positions c11, c12, c13, and c14, and potential pilot tone positions c15, c16, c17, and c18, respectively.

[0398] FIG. 45 further shows a first 108-subcarrier RU 4532 having pilot tone positions at potential pilot tone positions c1, c3, c4, c5, c7, and c8, a second 108-subcarrier RU 4534 having pilot tone positions at potential pilot tone positions c11, c12, c14, c15, c16, and c18, and a 242-subcarrier RU 4536 having pilot tone positions at potential pilot tone positions c1, c3, c5, c7, c12, c14, c16, and c18.

[0399] Each of the 52-, 108-, and 242-subcarrier RUs in FIG. 45 has pilot tone positions selected from among the pilot tone positions used by the RUs having fewer subcarriers that occupy the same bandwidth. Further, the pilot tone positions shown in FIG. 41 illustrates the mirror symmetry described with respect to FIG. 33A.

[0400] The options 5, 6, 7, 8, 9, 10, 11, 12, and 13 of Case 1 shown in FIGS. 37, 38, 39, 40, 41, 42, 43, 44, and 45, respectively, illustrate pilot tone positions for a 20 MHz bandwidth and when 108-subcarrier RUs are used instead of 106-subcarrier RUs. The pilot tone positions within the 26 subcarrier RU can be the suggested pilot tone positions embodiments described in the Design A section.

[0401] Resource Units (RUs) with larger sizes will have pilot frequency positions that are the same as or a subset of the pilot tone positions for aggregated 26-subcarrier RUs occupying the same frequencies. The 108-subcarrier RUs have 6 pilots within their respective RU allocation from among the eight potential pilot tone positions available for the 108-subcarrier RUs. The options 5 to 13 are different alternatives for the six pilot tone positions of the 108-subcarrier RUs and corresponding eight pilot tone positions of a 242-subcarrier RU. The pilot tone positions for 108 subcarrier RU and 242 subcarrier RU are chosen from the set of potential positions stemming from the pilot tone positions

of the 26 subcarrier RUs such that frequency diversity can be maximized (that is, so that the spacing between the pilots are large).

7. Larger (Greater than 20 MHz) Bandwidth

[0402] In an embodiment, pilot tone positions defined for a 20 MHz bandwidth are reused in the 40, 80, and 160 MHz bandwidths.

[0403] The 40 MHz bandwidth RU definitions are defined using two logical aggregated 20 MHz RU definitions. Except for the central RUs, the left 20 MHz of the 40 MHz bandwidth will have the RU definitions and pilot tone positions corresponding to a 20 MHz embodiment described above and the right 20 MHz of the 40 MHz bandwidth will also have the RU definitions and pilot tone positions corresponding to a 20 MHz embodiment.

[0404] Because the DC tones in the middle of a 20 MHz bandwidth does not exist in the left 20 MHz or right 20 MHz of the 40 MHz bandwidth, a central 26-subcarrier RUs does not exist in the left 20 MHz or right 20 MHz of the 40 MHz bandwidth. Accordingly, an even 26 subcarrier RU or an odd 26 subcarrier RU occupies a central portion of the left 20 MHz portion and the right 20 MHz portion of the 40 MHz bandwidth, said central portion corresponding to the area occupied by the central 26-subcarrier RU of a 20 MHz bandwidth. Whether an even or odd 26-subcarrier RU is used in the central portion depends on the precise location of the RU.

[0405] Similarly, for the 80 MHz bandwidth RU definitions, two 40 MHz RU definitions and associated (relative) pilot tone positions are used. A center 26-subcarrier RU may be disposed between the two 40 MHz RU definitions.

[0406] For the 160 MHz bandwidth RU definitions, two 80 MHz RU definitions and associated (relative) pilot tone positions are used.

[0407] FIGS. 46A to 53 illustrate embodiments of pilot tone positions for a 40 MHz bandwidth for Case 1.

[0408] In FIGS. 46A to 54, potential pilot tone positions are indicated by dotted lines extending vertically through the figures. Actual pilot tone for each RU are indicated by upward pointing arrows. A solid upward pointing arrow indicates a pilot tone with a fixed position. A dashed upward pointing arrow indicates a pilot tone having one of two positions, includes a first position to the left of a reference subcarrier and a second position to the right of a reference subcarrier, according to a design choice. In an embodiment, the reference subcarriers are center subcarriers of 13-subcarrier halves of 26-subcarrier RUs.

[0409] FIG. 46A illustrates a first option for pilot tone positions in Case 1 for a 40 MHz channel 4600, wherein at least one null or reserved tones is present between each 26-subcarrier RU. Pilot tone positions for each RU are selected from first to thirty-sixth potential pilot tone positions d1 to d36. FIG. 46B shows Table 10, which lists positions of each of the potential pilot tone positions d1 to d36 according to an embodiment, but embodiments are not limited thereto, and any of the pilot tone positions disclosed for 26-subchannel RUs in Design A, above, may be duplicated for use as the potential pilot tone positions d1 to d36. The order of the potential pilot tone positions d1 to d36 in Table 10 goes down the left sub-table and up the right sub-table to better illustrate the mirror symmetry of the potential pilot tone positions d1 to d36.

[0410] FIG. 46A shows, on the left side, a first 26-subcarrier RU 4602 having pilot tone positions at potential pilot

tone positions d1 and d2, a second 26-subcarrier RU 4604 having pilot tone positions at potential pilot tone positions d3 and d4, a third 26-subcarrier RU 4606 having pilot tone positions at potential pilot tone positions d5 and d6, a fourth 26-subcarrier RU 4608 having pilot tone positions at potential pilot tone positions d7 and d8, a fifth 26-subcarrier RU 4612 having pilot tone positions at potential pilot tone positions d9 and d10, a sixth 26-subcarrier RU 4614 having pilot tone positions at potential pilot tone positions d11 and d12, a seventh 26-subcarrier RU 4616 having pilot tone positions at potential pilot tone positions d13 and d14, an eighth 26-subcarrier RU 4618 having pilot tone positions at potential pilot tone positions d15 and d16, and a ninth 26-subcarrier RU 4620 having pilot tone positions at potential pilot tone positions d17 and d18.

[0411] FIG. 46A shows, on the right side, a tenth 26-subcarrier RU 4622 having pilot tone positions at potential pilot tone positions d19 and d20, an eleventh 26-subcarrier RU 4624 having pilot tone positions at potential pilot tone positions d21 and d22, a twelfth 26-subcarrier RU 4626 having pilot tone positions at potential pilot tone positions d23 and d24, a thirteenth 26-subcarrier RU 4628 having pilot tone positions at potential pilot tone positions d25 and d26, a fourteenth 26-subcarrier RU 4632 having pilot tone positions at potential pilot tone positions d27 and d28, a fifteenth 26-subcarrier RU 4634 having pilot tone positions at potential pilot tone positions d29 and d30, a sixteenth 26-subcarrier RU 4636 having pilot tone positions at potential pilot tone positions d31 and d32, a seventeenth 26-subcarrier RU 4638 having pilot tone positions at potential pilot tone positions d33 and d34, and an eighteenth 26-subcarrier RU 4640 having pilot tone positions at potential pilot tone positions d35 and d36.

[0412] FIG. 46A further shows, on the left side, a first 52-subcarrier RU 4642 having pilot tone positions at potential pilot tone positions d1, d2, d3, and d4, a second 52-subcarrier RU 4644 having pilot tone positions at potential pilot tone positions d5, d6, d7, and d8, a third 52-subcarrier RU 4646 having pilot tone positions at potential pilot tone positions d11, d12, d13, and d14, and a fourth 52-subcarrier RU 4648 having pilot tone positions at potential pilot tone positions d15, d16, d17, and d18.

[0413] FIG. 46A further shows, on the right side, a fifth 52-subcarrier RU 4652 having pilot tone positions at potential pilot tone positions d19, d22, d21, and d22 a sixth 52-subcarrier RU 4654 having pilot tone positions at potential pilot tone positions d23, d24, d25, and d26, a seventh 52-subcarrier RU 4656 having pilot tone positions at potential pilot tone positions d29, d30, d31, and d32, and an eighth 52-subcarrier RU 4658 having pilot tone positions at potential pilot tone positions d33, d34, d35, and d36.

[0414] FIG. 46A further shows a first 106-subcarrier RU 4662 having pilot tone positions at potential pilot tone positions d1, d3, d5, and d7, a second 106-subcarrier RU 4664 having pilot tone positions at potential pilot tone positions d11, d13, d15, and d17, a third 106-subcarrier RU 4666 having pilot tone positions at potential pilot tone positions d20, d22, d24, and d26, and a fourth 106-subcarrier RU 4668 having pilot tone positions at potential pilot tone positions d30, d32, d34, and d36.

[0415] FIG. 46A further shows a first 242-subcarrier RU 4672 having pilot tone positions at potential pilot tone positions d1, d3, d5, d7, d11, d13, d15, and d17, a second 242-subcarrier RU 4674 having pilot tone positions at

potential pilot tone positions d20, d22, d24, d26, d30, d32, d34, and d36, and a 484-subcarrier RU 4676 having pilot tone positions at potential pilot tone positions d1, d3, d5, d7, d11, d13, d15, d17, d20, d22, d24, d26, d30, d32, d34, and d36.

[0416] Each of the 52-, 106-, 242-, and 484-subcarrier RUs in FIG. 46A has pilot tone positions selected from among the pilot tone positions used by the RUs having fewer subcarriers that occupy the same bandwidth.

[0417] Furthermore, each RU in a lower 20 MHz of the 40 MHz channel 4600 has pilot tone positions that are mirror symmetric with a corresponding mirrored RU (that is, an RU with a same number of subcarriers and a same offset from the center of the 40 MHz channel 4600) of an upper 20 MHz of the 40 MHz channel 4600. For example, the pilot tone positions of the first 26-subcarrier RU 4602 are positioned to be mirror-symmetric to the pilot tone positions of the eighteenth 26-subcarrier RU 4640, the pilot tone positions of the second 52-subcarrier RU 4644 are positioned to be mirror-symmetric to the pilot tone positions of the seventh 52-subcarrier RU 4656, and so on.

[0418] FIG. 47 illustrates a second option for pilot tone positions in Case 1 for a 40 MHz bandwidth. In an embodiment, the second option may use the first to thirty-sixth potential pilot tone positions d1 to d36 as shown in Table 9 of FIG. 33B, but embodiments are not limited thereto, and any of the pilot tone positions disclosed for 26-subchannel RUs in Design A, above, may be duplicated for use as the potential pilot tone positions d1 to d36.

[0419] FIG. 47 shows first to eighteenth 26-subcarrier RUs 4702 to 4740 having pilot tone positions at the same potential pilot tone positions as the first to eighteenth 26-subcarrier RU 4602 to 4640 of FIG. 46A, respectively.

[0420] FIG. 47 shows first to eighth 52-subcarrier RUs 4742 to 4758 having pilot tone positions at the same potential pilot tone positions as the first to eighth 52-subcarrier RUs 4642 to 4658 of FIG. 46A, respectively.

[0421] FIG. 47 further shows a first 106-subcarrier RU 4762 having pilot tone positions at potential pilot tone positions d2, d4, d6, and d8, a second 106-subcarrier RU 4764 having pilot tone positions at potential pilot tone positions d12, d14, d16, and d18, a third 106-subcarrier RU 4766 having pilot tone positions at potential pilot tone positions d19, d21, d23, and d25, and a fourth 106-subcarrier RU 4768 having pilot tone positions at potential pilot tone positions d29, d31, d33, and d35.

[0422] FIG. 47 further shows a first 242-subcarrier RU 4772 having pilot tone positions at potential pilot tone positions d2, d4, d6, d8, d12, d14, d16, and d18, a second 242-subcarrier RU 4774 having pilot tone positions at potential pilot tone positions d19, d21, d23, d25, d29, d31, d33, and d35, and a 484-subcarrier RU 4776 having pilot tone positions at potential pilot tone positions d2, d4, d6, d8, d12, d14, d16, d18, d19, d21, d23, d25, d29, d31, d33, and d35.

[0423] Each of the 52-, 106-, 242-, and 484-subcarrier RUs in FIG. 47 has pilot tone positions selected from among the pilot tone positions used by the RUs having fewer subcarriers that occupy the same bandwidth. Furthermore, the pilot tone positions of FIG. 47 exhibit the mirror symmetry described above for FIG. 46A.

[0424] FIG. 48 illustrates a third option for pilot tone positions in Case 1 for a 40 MHz bandwidth. In an embodiment, the second option may use the first to thirty-sixth

potential pilot tone positions d1 to d36 as shown in Table 9 of FIG. 33B, but embodiments are not limited thereto.

[0425] FIG. 48 shows first to eighteenth 26-subcarrier RUs 4802 to 4840 having pilot tone positions at the same potential pilot tone positions as the first to eighteenth 26-subcarrier RU 4602 to 4640 of FIG. 46A, respectively.

[0426] FIG. 48 shows first to eighth 52-subcarrier RUs 4842 to 4858 having pilot tone positions at the same potential pilot tone positions as the first to eighth 52-subcarrier RUs 4642 to 4658 of FIG. 46A, respectively.

[0427] FIG. 48 further shows a first 106-subcarrier RU 4862 having pilot tone positions at potential pilot tone positions d1, d3, d5, and d7, a second 106-subcarrier RU 4864 having pilot tone positions at potential pilot tone positions d12, d14, d16, and d18, a third 106-subcarrier RU 4866 having pilot tone positions at potential pilot tone positions d19, d21, d23, and d25, and a fourth 106-subcarrier RU 4868 having pilot tone positions at potential pilot tone positions d30, d32, d34, and d36.

[0428] FIG. 48 further shows a first 242-subcarrier RU 4872 having pilot tone positions at potential pilot tone positions d1, d3, d5, d7, d12, d14, d16, and d18, a second 242-subcarrier RU 4874 having pilot tone positions at potential pilot tone positions d19, d21, d23, d25, d30, d32, d34, and d36, and a 484-subcarrier RU 4876 having pilot tone positions at potential pilot tone positions d1, d3, d5, d7, d12, d14, d16, d18, d19, d21, d23, d25, d30, d32, d34, and d36.

[0429] Each of the 52-, 106-, 242-, and 484-subcarrier RUs in FIG. 48 has pilot tone positions selected from among the pilot tone positions used by the RUs having fewer subcarriers that occupy the same bandwidth. Furthermore, the pilot tone positions of FIG. 48 exhibit the mirror symmetry described above for FIG. 46A.

[0430] FIG. 49 illustrates a fourth option for pilot tone positions in Case 1 for a 40 MHz bandwidth. In an embodiment, the fourth option may use the first to thirty-sixth potential pilot tone positions d1 to d36 as shown in Table 9 of FIG. 33B, but embodiments are not limited thereto.

[0431] FIG. 49 shows first to eighteenth 26-subcarrier RUs 4902 to 4940 having pilot tone positions at the same potential pilot tone positions as the first to eighteenth 26-subcarrier RU 4602 to 4640 of FIG. 46A, respectively.

[0432] FIG. 49 shows first to eighth 52-subcarrier RUs 4942 to 4958 having pilot tone positions at the same potential pilot tone positions as the first to eighth 52-subcarrier RUs 4642 to 4658 of FIG. 46A, respectively.

[0433] FIG. 49 further shows a first 108-subcarrier RU 4962 having pilot tone positions at potential pilot tone positions d1, d3, d4, d5, d6, and d8, a second 108-subcarrier RU 4964 having pilot tone positions at potential pilot tone positions d11, d13, d14, d15, d16, and d18, a third 108-subcarrier RU 4966 having pilot tone positions at potential pilot tone positions d19, d21, d22, d23, d24, and d26, and a fourth 108-subcarrier RU 4968 having pilot tone positions at potential pilot tone positions d29, d31, d32, d33, d34, and d36.

[0434] FIG. 49 further shows a first 242-subcarrier RU 4972 having pilot tone positions at potential pilot tone positions d1, d3, d6, d8, d11, d13, d16, and d18, a second 242-subcarrier RU 4974 having pilot tone positions at potential pilot tone positions d19, d21, d24, d26, d29, d31, d34, and d36, and a 484-subcarrier RU 4976 having pilot

tone positions at potential pilot tone positions d1, d3, d6, d8, d11, d13, d16, d18, d19, d21, d24, d26, d29, d31, d34, and d36.

[0435] Each of the 52-, 106-, 242-, and 484-subcarrier RUs in FIG. 49 has pilot tone positions selected from among the pilot tone positions used by the RUs having fewer subcarriers that occupy the same bandwidth. Furthermore, the pilot tone positions of FIG. 49 exhibit the mirror symmetry described above for FIG. 46A.

[0436] FIG. 50 illustrates a fifth option for pilot tone positions in Case 1 for a 40 MHz bandwidth. In an embodiment, the fifth option may use the first to thirty-sixth potential pilot tone positions d1 to d36 as shown in Table 9 of FIG. 33B, but embodiments are not limited thereto.

[0437] FIG. 50 shows first to eighteenth 26-subcarrier RUs 5002 to 5040 having pilot tone positions at the same potential pilot tone positions as the first to eighteenth 26-subcarrier RU 4602 to 4640 of FIG. 46A, respectively.

[0438] FIG. 50 shows first to eighth 52-subcarrier RUs 5042 to 5058 having pilot tone positions at the same potential pilot tone positions as the first to eighth 52-subcarrier RUs 4642 to 4658 of FIG. 46A, respectively.

[0439] FIG. 50 further shows a first 108-subcarrier RU 5062 having pilot tone positions at potential pilot tone positions d1, d3, d4, d5, d6, and d8, a second 108-subcarrier RU 5064 having pilot tone positions at potential pilot tone positions d11, d13, d14, d15, d16, and d18, a third 108-subcarrier RU 5066 having pilot tone positions at potential pilot tone positions d19, d21, d22, d23, d24, and d26, and a fourth 108-subcarrier RU 5068 having pilot tone positions at potential pilot tone positions d29, d31, d32, d33, d34, and d36.

[0440] FIG. 50 further shows a first 242-subcarrier RU 5072 having pilot tone positions at potential pilot tone positions d1, d4, d5, d8, d11, d14, d15, and d18, a second 242-subcarrier RU 5074 having pilot tone positions at potential pilot tone positions d19, d22, d23, d26, d29, d32, d33, and d36, and a 484-subcarrier RU 5076 having pilot tone positions at potential pilot tone positions d1, d4, d5, d8, d11, d14, d15, d18, d19, d22, d23, d26, d29, d32, d33, and d36.

[0441] Each of the 52-, 106-, 242-, and 484-subcarrier RUs in FIG. 50 has pilot tone positions selected from among the pilot tone positions used by the RUs having fewer subcarriers that occupy the same bandwidth. Furthermore, the pilot tone positions of FIG. 50 exhibit the mirror symmetry described above for FIG. 46A.

[0442] FIG. 51 illustrates a sixth option for pilot tone positions in Case 1 for a 40 MHz bandwidth. In an embodiment, the sixth option may use the first to thirty-sixth potential pilot tone positions d1 to d36 as shown in Table 9 of FIG. 33B, but embodiments are not limited thereto.

[0443] FIG. 51 shows first to eighteenth 26-subcarrier RUs 5102 to 5140 having pilot tone positions at the same potential pilot tone positions as the first to eighteenth 26-subcarrier RU 4602 to 4640 of FIG. 46A, respectively.

[0444] FIG. 51 shows first to eighth 52-subcarrier RUs 5142 to 5158 having pilot tone positions at the same potential pilot tone positions as the first to eighth 52-subcarrier RUs 4642 to 4658 of FIG. 46A, respectively.

[0445] FIG. 51 further shows a first 108-subcarrier RU 5162 having pilot tone positions at potential pilot tone positions d1, d2, d4, d5, d7, and d8, a second 108-subcarrier RU 5164 having pilot tone positions at potential pilot tone

positions d11, d12, d14, d15, d17, and d18, a third 108-subcarrier RU 5166 having pilot tone positions at potential pilot tone positions d19, d20, d22, d23, d25, and d26, and a fourth 108-subcarrier RU 5168 having pilot tone positions at potential pilot tone positions d29, d30, d32, d33, d35, and d36.

[0446] FIG. 51 further shows a first 242-subcarrier RU 5172 having pilot tone positions at potential pilot tone positions d1, d3, d4, d7, d12, d15, d17, and d18, a second 242-subcarrier RU 5174 having pilot tone positions at potential pilot tone positions d19, d20, d22, d25, d30, d33, d35, and d36, and a 484-subcarrier RU 5176 having pilot tone positions at potential pilot tone positions d1, d3, d4, d7, d12, d15, d17, d18, d19, d20, d22, d25, d30, d33, d35, and d36.

[0447] Each of the 52-, 106-, 242-, and 484-subcarrier RUs in FIG. 51 has pilot tone positions selected from among the pilot tone positions used by the RUs having fewer subcarriers that occupy the same bandwidth. Furthermore, the pilot tone positions of FIG. 51 exhibit the mirror symmetry described above for FIG. 46A.

[0448] FIG. 52 illustrates a seventh option for pilot tone positions in Case 1 for a 40 MHz bandwidth. In an embodiment, the seventh option may use the first to thirty-sixth potential pilot tone positions d1 to d36 as shown in Table 9 of FIG. 33B, but embodiments are not limited thereto.

[0449] FIG. 52 shows first to eighteenth 26-subcarrier RUs 5202 to 5240 having pilot tone positions at the same potential pilot tone positions as the first to eighteenth 26-subcarrier RU 4602 to 4640 of FIG. 46A, respectively.

[0450] FIG. 52 shows first to eighth 52-subcarrier RUs 5242 to 5258 having pilot tone positions at the same potential pilot tone positions as the first to eighth 52-subcarrier RUs 4642 to 4658 of FIG. 46A, respectively.

[0451] FIG. 52 further shows a first 108-subcarrier RU 5262 having pilot tone positions at potential pilot tone positions d1, d2, d4, d5, d7, and d8, a second 108-subcarrier RU 5264 having pilot tone positions at potential pilot tone positions d11, d12, d14, d15, d17, and d18, a third 108-subcarrier RU 5266 having pilot tone positions at potential pilot tone positions d19, d20, d22, d23, d25, and d26, and a fourth 108-subcarrier RU 5268 having pilot tone positions at potential pilot tone positions d29, d30, d32, d33, d35, and d36.

[0452] FIG. 52 further shows a first 242-subcarrier RU 5272 having pilot tone positions at potential pilot tone positions d1, d2, d5, d8, d11, d14, d17, and d18, a second 242-subcarrier RU 5274 having pilot tone positions at potential pilot tone positions d19, d20, d23, d26, d29, d32, d35, and d36, and a 484-subcarrier RU 5276 having pilot tone positions at potential pilot tone positions d1, d2, d5, d8, d11, d14, d17, d18, d19, d20, d23, d26, d29, d32, d35, and d36.

[0453] Each of the 52-, 106-, 242-, and 484-subcarrier RUs in FIG. 52 has pilot tone positions selected from among the pilot tone positions used by the RUs having fewer subcarriers that occupy the same bandwidth. Furthermore, the pilot tone positions of FIG. 52 exhibit the mirror symmetry described above for FIG. 46A.

[0454] FIG. 53 illustrates an eighth option for pilot tone positions in Case 1 for a 40 MHz bandwidth. In an embodiment, the eighth option may use the first to thirty-sixth potential pilot tone positions d1 to d36 as shown in Table 9 of FIG. 33B, but embodiments are not limited thereto.

[0455] FIG. 53 shows first to eighteenth 26-subcarrier RUs 5302 to 5340 having pilot tone positions at the same potential pilot tone positions as the first to eighteenth 26-subcarrier RU 4602 to 4640 of FIG. 46A, respectively.

[0456] FIG. 53 shows first to eighth 52-subcarrier RUs 5342 to 5358 having pilot tone positions at the same potential pilot tone positions as the first to eighth 52-subcarrier RUs 4642 to 4658 of FIG. 46A, respectively.

[0457] FIG. 53 further shows a first 108-subcarrier RU 5362 having pilot tone positions at potential pilot tone positions d1, d2, d4, d5, d7, and d8, a second 108-subcarrier RU 5364 having pilot tone positions at potential pilot tone positions d11, d12, d14, d15, d17, and d18, a third 108-subcarrier RU 5366 having pilot tone positions at potential pilot tone positions d19, d20, d22, d23, d25, and d26, and a fourth 108-subcarrier RU 5368 having pilot tone positions at potential pilot tone positions d29, d30, d32, d33, d35, and d36.

[0458] FIG. 53 further shows a first 242-subcarrier RU 5372 having pilot tone positions at potential pilot tone positions d1, d4, d5, d8, d11, d14, d15, and d18, a second 242-subcarrier RU 5374 having pilot tone positions at potential pilot tone positions d19, d22, d23, d26, d29, d32, d33, and d36, and a 484-subcarrier RU 5376 having pilot tone positions at potential pilot tone positions d1, d4, d5, d8, d11, d14, d15, d18, d19, d22, d23, d26, d29, d32, d33, and d36.

[0459] Each of the 52-, 106-, 242-, and 484-subcarrier RUs in FIG. 53 has pilot tone positions selected from among the pilot tone positions used by the RUs having fewer subcarriers that occupy the same bandwidth. Furthermore, the pilot tone positions of FIG. 53 exhibit the mirror symmetry described above for FIG. 46A.

[0460] Case 2 embodies RU definition design with 26 subcarrier RUs, 52 subcarriers RUs, 106 or 108 subcarrier RUs, 242 subcarrier RUs, 484 subcarrier RUs, and 994 or 996 subcarrier RUs, wherein pairs of consecutive 26 subcarrier RUs line up (frequency wise) with 52 subcarrier RUs, except for the central 26 subcarrier RU within each 20 MHz bandwidth.

[0461] In FIGS. 54A to 58, potential pilot tone positions are indicated by dotted lines extending vertically through the figures. Actual pilot tone for each RU are indicated by upward pointing arrows. A solid upward pointing arrow indicates a pilot tone with a fixed position. A dashed upward pointing arrow indicates a pilot tone having one of two positions, includes a first position to the left of a reference subcarrier and a second position to the right of a reference subcarrier, according to a design choice. In an embodiment, the reference subcarriers are center subcarriers of 13-subcarrier halves of 26-subcarrier RUs.

[0462] FIG. 54A illustrates a first option for pilot tone positions for a 20 MHz channel 5400 in Case 2. Pilot tone positions for each RU are selected from first to eighteenth potential pilot tone positions e1 to e18. FIG. 54B shows Table 11, which lists the positions of each of the potential pilot tone positions e1 to e18 according to an embodiment.

[0463] FIG. 54A shows a first 26-subcarrier RU 5402 having pilot tone positions at potential pilot tone positions e1 and e2, a second 26-subcarrier RU 5404 having pilot tone positions at potential pilot tone positions e3 and e4, a third 26-subcarrier RU 5406 having pilot tone positions at potential pilot tone positions e5 and e6, a fourth 26-subcarrier RU 5408 having pilot tone positions at potential pilot tone

positions e7 and e8, a fifth (center) 26-subcarrier RU 5410 having pilot tone positions at potential pilot tone positions e9 and e10, a sixth 26-subcarrier RU 5412 having pilot tone positions at potential pilot tone positions e11 and e12, a seventh 26-subcarrier RU 5414 having pilot tone positions at potential pilot tone positions e13 and e14, an eighth 26-subcarrier RU 5416 having pilot tone positions at potential pilot tone positions e15 and e16, and a ninth 26-subcarrier RU 5418 having pilot tone positions at potential pilot tone positions e17 and e18.

[0464] FIG. 54A further shows a first 52-subcarrier RU 5422 having pilot tone positions at potential pilot tone positions e1, e2, e3, and e4, a second 52-subcarrier RU 5424 having pilot tone positions at potential pilot tone positions e5, e6, e7, and e8, a third 52-subcarrier RU 5426 having pilot tone positions at potential pilot tone positions e11, e12, e13, and e14, and a fourth 52-subcarrier RU 5428 having pilot tone positions at potential pilot tone positions e15, e16, e17, and e18.

[0465] FIG. 54A further shows a first 106-subcarrier RU 5432 having pilot tone positions at potential pilot tone positions e1, e3, e5, and e7, a second 106-subcarrier RU 5434 having pilot tone positions at potential pilot tone positions e12, e14, e16, and e18, and a 242-subcarrier RU 5436 having pilot tone positions at potential pilot tone positions e1, e3, e5, e7, e12, e14, e16, and e18.

[0466] Each of the 52-, 106-, and 242-subcarrier RUs in FIG. 54A has pilot tone positions selected from among the pilot tone positions used by the RUs having fewer subcarriers that occupy the same bandwidth.

[0467] Furthermore, each RU in a lower 10 MHz of the 20 MHz channel 5400 has pilot tone positions that are mirror symmetric with a corresponding mirrored RU (that is, an RU with a same number of subcarriers and a same offset from the center of the 20 MHz channel 5400) of an upper 10 MHz of the 20 MHz channel 5400. For example, the pilot tone positions of the first 26-subcarrier RU 5402 are positioned to be mirror-symmetric to the pilot tone positions of the ninth 26-subcarrier RU 5418, the pilot tone positions of the second 52-subcarrier RU 5424 are positioned to be mirror-symmetric to the pilot tone positions of the third 52-subcarrier RU 5426, and so on.

[0468] FIG. 55 illustrates a second option for pilot tone positions in Case 2. In an embodiment, the second option may use the first to eighteenth potential pilot tone positions e1 to e18 as shown in Table 11 of FIG. 54B, but embodiments are not limited thereto.

[0469] FIG. 55 shows a first, second, third, and fourth 26-subcarrier RU 5502, 5504, 5506, and 5508 having pilot tone positions at potential pilot tone positions e1 and e2, e3 and e4, e5 and e6, and e7 and e8, respectively, a fifth (center) 26-subcarrier RU 5510 having pilot tone positions at potential pilot tone positions e9 and e11, and sixth, seventh, eighth, and ninth 26-subcarrier RU 5512, 5514, 5516, and 5518 having pilot tone positions at potential pilot tone positions e11 and e12, e13 and e14, e15 and e16, and e17 and e18, respectively.

[0470] FIG. 55 further shows a first, second, third, and fourth 52-subcarrier RU 5522, 5524, 5526, and 5528 having pilot tone positions at potential pilot tone positions e1, e2, e3, and e4, potential pilot tone positions e5, e6, e7, and e8, potential pilot tone positions e11, e12, e13, and e14, and potential pilot tone positions e15, e16, e17, and e18, respectively.

[0471] FIG. 55 further shows a first 106-subcarrier RU 5532 having pilot tone positions at potential pilot tone positions e1, e3, e6, and e8, a second 106-subcarrier RU 5534 having pilot tone positions at potential pilot tone positions e11, e13, e16, and e18, and a 242-subcarrier RU 5536 having pilot tone positions at potential pilot tone positions e1, e3, e6, e8, e11, e13, e16, and e18.

[0472] Each of the 52-, 106-, and 242-subcarrier RUs in FIG. 55 has pilot tone positions selected from among the pilot tone positions used by the RUs having fewer subcarriers that occupy the same bandwidth. Furthermore, the pilot tone positions of FIG. 55 exhibit the mirror symmetry described above for FIG. 54A.

[0473] FIG. 56 illustrates a third option for pilot tone positions in Case 2. In an embodiment, the third option may use the first to eighteenth potential pilot tone positions e1 to e18 as shown in Table 11 of FIG. 54B, but embodiments are not limited thereto.

[0474] FIG. 56 shows a first, second, third, and fourth 26-subcarrier RU 5602, 5604, 5606, and 5608 having pilot tone positions at potential pilot tone positions e1 and e2, e3 and e4, e5 and e6, and e7 and e8, respectively, a fifth (center) 26-subcarrier RU 5610 having pilot tone positions at potential pilot tone positions e9 and e11), and sixth, seventh, eighth, and ninth 26-subcarrier RU 5612, 5614, 5616, and 5618 having pilot tone positions at potential pilot tone positions e11 and e12, e13 and e14, e15 and e16, and e17 and e18, respectively.

[0475] FIG. 56 further shows a first, second, third, and fourth 52-subcarrier RU 5622, 5624, 5626, and 5628 having pilot tone positions at potential pilot tone positions e1, e2, e3, and e4, potential pilot tone positions e5, e6, e7, and e8, potential pilot tone positions e11, e12, e13, and e14, and potential pilot tone positions e15, e16, e17, and e18, respectively.

[0476] FIG. 56 further shows a first 106-subcarrier RU 5632 having pilot tone positions at potential pilot tone positions e2, e4, e6, and e8, a second 106-subcarrier RU 5634 having pilot tone positions at potential pilot tone positions e11, e13, e15, and e17, and a 242-subcarrier RU 5636 having pilot tone positions at potential pilot tone positions e2, e4, e6, e8, e11, e13, e15, and e17.

[0477] Each of the 52-, 106-, and 242-subcarrier RUs in FIG. 56 has pilot tone positions selected from among the pilot tone positions used by the RUs having fewer subcarriers that occupy the same bandwidth. Furthermore, the pilot tone positions of FIG. 56 exhibit the mirror symmetry described above for FIG. 54A.

[0478] Options 1, 2, and 3 for Case 2 as shown in FIGS. 54A, 55, and 56, respectively, represent pilot tone positions for a 20 MHz bandwidth and when a 106-subcarrier RU is used instead of a 108-subcarrier RU. The pilot tone positions within the 26-subcarrier RU can be the suggested pilot tone positions embodiments described in Design A section.

[0479] Resource Units (RUs) with larger sizes will have identical pilot frequency positions as the pilot tone positions for aggregated 26 subcarrier RUs.

[0480] The 106-subcarrier RUs respectively have 4 pilots within their RU allocations. However, there are potentially 8 pilot tone positions available for the 106 subcarrier RU. The options 1, 2, and 3 shown in FIGS. 54A, 55, and 56, respectively, are different alternatives to the pilot tone positions of the 106 subcarrier RUs and 242 subcarrier RU. The pilot tone positions for 106 subcarrier RU and 242 subcarrier

RU are chosen from the set of potential positions stemming from the pilot tone positions of the 26 subcarrier RUs such that frequency diversity can be maximized (e.g. spacing between pilots are large). In case 2, the edge of the 106 subcarrier RU is lined up with 26 subcarrier and 52 subcarrier RUs.

[0481] FIG. 57 illustrates a fourth and a fifth option for pilot tone positions in Case 2. In an embodiment, the fourth and fifth options may each use the first to eighteenth potential pilot tone positions e1 to e18 as shown in Table 11 of FIG. 54B, but embodiments are not limited thereto.

[0482] The fourth and fifth option respectively have identical pilot tone positions for 26-, 52-, and 108-subcarrier RUs. Pilot tone positions for an option-four 242-subcarrier RU 5736A of option four are different from pilot tone positions for an option-five 242-subcarrier RU 5736B of option five.

[0483] FIG. 57 shows a first, second, third, and fourth 26-subcarrier RU 5702, 5704, 5706, and 5708 having pilot tone positions at potential pilot tone positions e1 and e2, e3 and e4, e5 and e6, and e7 and e8, respectively, a fifth (center) 26-subcarrier RU 5710 having pilot tone positions at potential pilot tone positions e9 and e11), and sixth, seventh, eighth, and ninth 26-subcarrier RU 5712, 5714, 5716, and 5718 having pilot tone positions at potential pilot tone positions e11 and e12, e13 and e14, e15 and e16, and e17 and e18, respectively.

[0484] FIG. 57 further shows a first, second, third, and fourth 52-subcarrier RU 5722, 5724, 5726, and 5728 having pilot tone positions at potential pilot tone positions e1, e2, e3, and e4, potential pilot tone positions e5, e6, e7, and e8, potential pilot tone positions e11, e12, e13, and e14, and potential pilot tone positions e15, e16, e17, and e18, respectively.

[0485] FIG. 57 further shows a first 108-subcarrier RU 5732 having pilot tone positions at potential pilot tone positions e1, e3, e4, e5, e6, and e8, and a second 108-subcarrier RU 5734 having pilot tone positions at potential pilot tone positions e11, e13, e14, e15, e16, and e18.

[0486] FIG. 57 further shows the option-four 242-subcarrier RU 5736A of option four having pilot tone positions at potential pilot tone positions e1, e3, e6, e8, e11, e13, e16, and e18, and the option-five 242-subcarrier RU 5736A of option five having pilot tone positions at potential pilot tone positions e1, e4, e5, e8, e11, e14, e15, and e18.

[0487] Each of the 52-, 108-, and 242-subcarrier RUs in FIG. 57 has pilot tone positions selected from among the pilot tone positions used by the RUs having fewer subcarriers that occupy the same bandwidth. Furthermore, the pilot tone positions of FIG. 57 exhibit the mirror symmetry described above for FIG. 54A.

[0488] FIG. 58 illustrates a sixth option for pilot tone positions in Case 2. In an embodiment, the sixth option may use the first to eighteenth potential pilot tone positions e1 to e18 as shown in Table 11 of FIG. 54B, but embodiments are not limited thereto.

[0489] FIG. 58 shows a first, second, third, and fourth 26-subcarrier RU 5802, 5804, 5806, and 5808 having pilot tone positions at potential pilot tone positions e1 and e2, e3 and e4, e5 and e6, and e7 and e8, respectively, a fifth (center) 26-subcarrier RU 5810 having pilot tone positions at potential pilot tone positions e9 and e11), and sixth, seventh, eighth, and ninth 26-subcarrier RU 5812, 5814, 5816, and

5818 having pilot tone positions at potential pilot tone positions e11 and e12, e13 and e14, e15 and e16, and e17 and e18, respectively.

[0490] FIG. 58 further shows a first, second, third, and fourth 52-subcarrier RU **5822**, **5824**, **5826**, and **5828** having pilot tone positions at potential pilot tone positions e1, e2, e3, and e4, potential pilot tone positions e5, e6, e7, and e8, potential pilot tone positions e11, e12, e13, and e14, and potential pilot tone positions e15, e16, e17, and e18, respectively.

[0491] FIG. 58 further shows a first 108-subcarrier RU **5832** having pilot tone positions at potential pilot tone positions e1, e2, e4, e5, e7, and e8, a second 108-subcarrier RU **5834** having pilot tone positions at potential pilot tone positions e11, e12, e14, e15, e17, and e18, and a 242-subcarrier RU **5836** having pilot tone positions at potential pilot tone positions e1, e4, e5, e8, e11, e14, e15, and e18.

[0492] Each of the 52-, 108-, and 242-subcarrier RUs in FIG. 58 has pilot tone positions selected from among the pilot tone positions used by the RUs having fewer subcarriers that occupy the same bandwidth. Furthermore, the pilot tone positions of FIG. 58 exhibit the mirror symmetry described above for FIG. 54A.

[0493] Options 4, 5, and 6 of Case 2 shown in FIGS. 57, 57, and 58, respectively, represent pilot tone positions for a 20 MHz bandwidth and when a 108-subcarrier RU is used instead of a 106-subcarrier RU. The pilot tone positions within the 26-subcarrier RUs can be the suggested pilot tone positions embodiments described in Design A section.

[0494] Resource Units (RUs) with larger sizes will have identical pilot frequency positions as the pilot tone positions for aggregated 26 subcarrier RUs. 108-subcarrier RUs have 6 pilots within their respective RU allocation and the 242-subcarrier RU has 8 pilots within its RU allocation. However, there are potentially 8 potential pilot tone positions available for the 108-subcarrier RU and 18 potential pilot tone positions for the 242 subcarrier RU.

[0495] The options 4, 5, and 6 are different alternatives for the pilot tone positions of the 108-subcarrier RUs and 242-subcarrier RU. The pilot tone positions for 108 subcarrier RU and 242 subcarrier RU are chosen from the set of potential positions stemming from the pilot tone positions of the 26 subcarrier RUs such that frequency diversity can be maximized (e.g. spacing between pilots are large).

[0496] Pilot tone positions of 40, 80, and 160 MHz bandwidths for case 2 are defined using the concatenated (relative) pilot tone positions of the 20 MHz bandwidth pilot tone positions. As in Case 1, central 26-subcarrier RUs in left and right 20 MHz portions of a 40 MHz bandwidth are respectively replaced by an even or odd 26-subcarrier RU. An 80 MHz bandwidth will use two concatenated 40 MHz pilot tone positions with a single central 26-subcarrier RU in the middle. FIGS. 59 to 65 illustrate embodiments of pilot tone positions for a 40 MHz bandwidth for Case 2.

[0497] In FIGS. 59 to 65, potential pilot tone positions are indicated by dotted lines extending vertically through the figures. Actual pilot tone for each RU are indicated by upward pointing arrows. A solid upward pointing arrow indicates a pilot tone with a fixed position. A dashed upward pointing arrow indicates a pilot tone having one of two positions, includes a first position to the left of a reference subcarrier and a second position to the right of a reference subcarrier, according to a design choice. In an embodiment,

the reference subcarriers are center subcarriers of 13-subcarrier halves of 26-subcarrier RUs.

[0498] FIG. 59A illustrates a first option for pilot tone positions in Case 2 for a 40 MHz channel **5900**. Pilot tone positions for each RU are selected from first to thirty-sixth potential pilot tone positions f1 to f36. FIG. 59B shows Table 12, which lists positions of each of the potential pilot tone positions f1 to f36 according to an embodiment, but embodiments are not limited thereto. The order of the potential pilot tone positions f1 to f36 in Table 10 goes down the left sub-table and up the right sub-table to better illustrate the mirror symmetry of the potential pilot tone positions f1 to f36. Therefore, the pilot tone positions f1 to f36 meets the following relationship: f1=f36, f2=f35, f3=f34, f4=f33, f5=f32, f6=f31, f7=f30, f8=f29, f9=f28, f10=f27, f11=f26, f12=f25, f13=f24, f14=f23, f15=f22, f16=f21, f17=f20, and f18=f19 (f36>f35>f34>f33>f32>f31>f30>f29>f28>f27>f26>f25>f24>f23>f22>f21>f20>f19

[0499] FIG. 59A shows, on the left side, a first 26-subcarrier RU **5902** having pilot tone positions at potential pilot tone positions f1 and f2, a second 26-subcarrier RU **5904** having pilot tone positions at potential pilot tone positions f3 and f4, a third 26-subcarrier RU **5906** having pilot tone positions at potential pilot tone positions f5 and f6, a fourth 26-subcarrier RU **5908** having pilot tone positions at potential pilot tone positions f7 and f8, a fifth 26-subcarrier RU **5912** having pilot tone positions at potential pilot tone positions f9 and f10, a sixth 26-subcarrier RU **5914** having pilot tone positions at potential pilot tone positions f11 and f12, a seventh 26-subcarrier RU **5916** having pilot tone positions at potential pilot tone positions f13 and f14, an eighth 26-subcarrier RU **5918** having pilot tone positions at potential pilot tone positions f15 and f16, and a ninth 26-subcarrier RU **5920** having pilot tone positions at potential pilot tone positions f17 and f18.

[0500] FIG. 59A shows, on the right side, a tenth 26-subcarrier RU **5922** having pilot tone positions at potential pilot tone positions f19 and f20, an eleventh 26-subcarrier RU **5924** having pilot tone positions at potential pilot tone positions f21 and f22, a twelfth 26-subcarrier RU **5926** having pilot tone positions at potential pilot tone positions f23 and f24, a thirteenth 26-subcarrier RU **5928** having pilot tone positions at potential pilot tone positions f25 and f26, a fourteenth 26-subcarrier RU **5932** having pilot tone positions at potential pilot tone positions f27 and f28, a fifteenth 26-subcarrier RU **5934** having pilot tone positions at potential pilot tone positions f29 and f30, a sixteenth 26-subcarrier RU **5936** having pilot tone positions at potential pilot tone positions f31 and f32, a seventeenth 26-subcarrier RU **5938** having pilot tone positions at potential pilot tone positions f33 and f34, and an eighteenth 26-subcarrier RU **5940** having pilot tone positions at potential pilot tone positions f35 and f36.

[0501] In each of the 26-subcarrier RUs **5902** to **5940**, respective first and second pilot tone positions correspond to potential pilot tone positions covered by the respective 26 subcarriers.

[0502] FIG. 59A further shows, on the left side, a first 52-subcarrier RU **5942** having pilot tone positions at potential pilot tone positions f1, f2, f3, and f4, a second 52-subcarrier RU **5944** having pilot tone positions at potential pilot tone positions f5, f6, f7, and f8, a third 52-subcarrier RU **5959** having pilot tone positions at potential pilot tone positions f11, f12, f13, and f14, and a fourth 52-subcarrier

RU **5948** having pilot tone positions at potential pilot tone positions f15, f16, f17, and f18.

[0503] FIG. **59A** further shows, on the right side, a fifth 52-subcarrier RU **5952** having pilot tone positions at potential pilot tone positions f19, f22, f21, and f22 a sixth 52-subcarrier RU **5954** having pilot tone positions at potential pilot tone positions f23, f24, f25, and f26, a seventh 52-subcarrier RU **5956** having pilot tone positions at potential pilot tone positions f29, f30, f31, and f32, and an eighth 52-subcarrier RU **5958** having pilot tone positions at potential pilot tone positions f33, f34, f35, and f36.

[0504] In each of the 52-subcarrier RUs **5942** to **5958**, respective first, second, third, and fourth pilot tone positions correspond to potential pilot tone positions covered by the respective 52 subcarriers.

[0505] FIG. **59A** further shows a first 106-subcarrier RU **5962** having pilot tone positions at potential pilot tone positions f1, f3, f6, and f8, a second 106-subcarrier RU **5964** having pilot tone positions at potential pilot tone positions f11, f13, f16, and f18, a third 106-subcarrier RU **5966** having pilot tone positions at potential pilot tone positions f19, f21, f24, and f26, and a fourth 106-subcarrier RU **5968** having pilot tone positions at potential pilot tone positions f29, f31, f34, and f36. In each of the 106-subcarrier RUs **5962** to **5968**, a first pilot tone position has an index corresponding to a lowest index among potential pilot tone positions covered by the RU, a second pilot tone position is spaced two potential pilot tone positions away from the first pilot tone position, a third pilot tone position spaced three potential pilot tone positions away from the second pilot tone position, and a fourth pilot tone position spaced two potential pilot tone positions away from the third pilot tone position.

[0506] FIG. **59A** further shows a first 242-subcarrier RU **5972** having pilot tone positions at potential pilot tone positions f1, f3, f6, f8, f11, f13, f16, and f18, a second 242-subcarrier RU **5974** having pilot tone positions at potential pilot tone positions f19, f21, f24, f26, f29, f31, f34, and f36. In each of the first and second 242-subcarrier RUs **5972** and **5974**, a first pilot tone position has a lowest index among potential pilot tone positions covered by the 242 subcarriers, a second pilot tone position is spaced two potential pilot tone positions away from the first pilot tone position, a third pilot tone position is spaced three potential pilot tone positions away from the second pilot tone position, a fourth pilot tone position is spaced two potential pilot tone positions away from the third pilot tone position, a fifth pilot tone position is spaced three potential pilot tone positions away from the fourth pilot tone position, a sixth pilot tone position is spaced two potential pilot tone positions away from the fifth pilot tone position, a seventh pilot tone position is spaced three potential pilot tone positions away from the sixth pilot tone position, and an eighth pilot tone position is spaced two potential pilot tone positions away from the seventh pilot tone position.

[0507] FIG. **59A** further shows a 484-subcarrier RU **5976** having pilot tone positions at potential pilot tone positions f1, f3, f6, f8, f11, f13, f16, f18, f19, f21, f24, f26, f29, f31, f34, and f36. The 484-subcarrier RU **5976** has a first pilot tone position having a lowest index among potential pilot tone positions covered by the 242 subcarriers, and second, third, fourth, fifth, sixth, seventh, eighth, ninth, tenth, eleventh, twelfth, thirteenth, fourteenth, fifteenth, and sixteenth pilot tone positions spaced 2, 3, 2, 3, 2, 3, 2, 1, 2, 3, 2, 3, 2,

3, 2 potential pilot tone positions away from the first, second, third, fourth, fifth, sixth, seventh, eighth, ninth, tenth, eleventh, twelfth, thirteenth, fourteenth, and fifteenth pilot tone position, respectively.

[0508] Each of the 52-, 106-, 242-, and 484-subcarrier RUs in FIG. **59A** has pilot tone positions selected from among the pilot tone positions used by the RUs having fewer subcarriers that occupy the same bandwidth.

[0509] Furthermore, each RU in a lower 20 MHz of the 40 MHz channel **5900** has pilot tone positions that are mirror symmetric with a corresponding mirrored RU (that is, an RU with a same number of subcarriers and a same offset from the center of the 40 MHz channel **4900**) of an upper 20 MHz of the 40 MHz channel **4900**. For example, the pilot tone positions of the first 26-subcarrier RU **5902** are positioned to be mirror-symmetric to the pilot tone positions of the eighteenth 26-subcarrier RU **5940**, the pilot tone positions of the second 52-subcarrier RU **5944** are positioned to be mirror-symmetric to the pilot tone positions of the seventh 52-subcarrier RU **5956**, and so on.

[0510] FIG. **60** illustrates a second option for pilot tone positions in Case 2 for a 40 MHz bandwidth. In an embodiment, the second option may use the first to thirty-sixth potential pilot tone positions f1 to f36 as shown in Table 9 of FIG. **33B**, but embodiments are not limited thereto.

[0511] FIG. **60** shows first to eighteenth 26-subcarrier RUs **6002** to **6040** having pilot tone positions at the same potential pilot tone positions as the first to eighteenth 26-subcarrier RU **5902** to **5940** of FIG. **59A**, respectively.

[0512] FIG. **60** shows first to eighth 52-subcarrier RUs **6042** to **6058** having pilot tone positions at the same potential pilot tone positions as the first to eighth 52-subcarrier RUs **5942** to **5958** of FIG. **59A**, respectively.

[0513] FIG. **60** further shows a first 106-subcarrier RU **6062** having pilot tone positions at potential pilot tone positions f1, f3, f5, and f7, a second 106-subcarrier RU **6064** having pilot tone positions at potential pilot tone positions f11, f13, f15, and f17, a third 106-subcarrier RU **6066** having pilot tone positions at potential pilot tone positions f20, f22, f24, and f26, and a fourth 106-subcarrier RU **6068** having pilot tone positions at potential pilot tone positions f30, f32, f34, and f36.

[0514] FIG. **60** further shows a first 242-subcarrier RU **6072** having pilot tone positions at potential pilot tone positions f1, f3, f5, f7, f11, f13, f15, and f17, a second 242-subcarrier RU **6074** having pilot tone positions at potential pilot tone positions f20, f22, f24, f26, f30, f32, f34, and f36, and a 484-subcarrier RU **6076** having pilot tone positions at potential pilot tone positions f1, f3, f5, f7, f11, f13, f15, f17, f20, f22, f24, f26, f30, f32, f34, and f36.

[0515] Each of the 52-, 106-, 242-, and 484-subcarrier RUs in FIG. **60** has pilot tone positions selected from among the pilot tone positions used by the RUs having fewer subcarriers that occupy the same bandwidth. Furthermore, the pilot tone positions of FIG. **60** exhibit the mirror symmetry described above for FIG. **59A**.

[0516] FIG. **61** illustrates a third option for pilot tone positions in Case 2 for a 40 MHz bandwidth. In an embodiment, the third option may use the first to thirty-sixth potential pilot tone positions f1 to f36 as shown in Table 9 of FIG. **33B**, but embodiments are not limited thereto.

[0517] FIG. **61** shows first to eighteenth 26-subcarrier RUs **6102** to **6140** having pilot tone positions at the same

potential pilot tone positions as the first to eighteenth 26-subcarrier RU **5902** to **5940** of FIG. **59A**, respectively.

[**0518**] FIG. **61** shows first to eighth 52-subcarrier RUs **6142** to **6158** having pilot tone positions at the same potential pilot tone positions as the first to eighth 52-subcarrier RUs **5942** to **5958** of FIG. **59A**, respectively.

[**0519**] FIG. **61** further shows a first 106-subcarrier RU **6162** having pilot tone positions at potential pilot tone positions f2, f4, f6, and f8, a second 106-subcarrier RU **6164** having pilot tone positions at potential pilot tone positions f12, f14, f16, and f18, a third 106-subcarrier RU **6166** having pilot tone positions at potential pilot tone positions f19, f21, f23, and f25, and a fourth 106-subcarrier RU **6168** having pilot tone positions at potential pilot tone positions f29, f31, f33, and f35.

[**0520**] FIG. **61** further shows a first 242-subcarrier RU **6172** having pilot tone positions at potential pilot tone positions f2, f4, f6, f8, f12, f14, f16, and f18, a second 242-subcarrier RU **6174** having pilot tone positions at potential pilot tone positions f19, f21, f23, f25, f29, f31, f33, and f35, and a 484-subcarrier RU **6176** having pilot tone positions at potential pilot tone positions f2, f4, f6, f8, f12, f14, f16, f18, f19, f21, f23, f25, f29, f31, f33, and f35.

[**0521**] Each of the 52-, 106-, 242-, and 484-subcarrier RUs in FIG. **61** has pilot tone positions selected from among the pilot tone positions used by the RUs having fewer subcarriers that occupy the same bandwidth. Furthermore, the pilot tone positions of FIG. **61** exhibit the mirror symmetry described above for FIG. **59A**.

[**0522**] FIG. **62** illustrates a fourth option for pilot tone positions in Case 2 for a 40 MHz bandwidth. In an embodiment, the fourth option may use the first to thirty-sixth potential pilot tone positions f1 to f36 as shown in Table 9 of FIG. **33B**, but embodiments are not limited thereto.

[**0523**] FIG. **62** shows first to eighteenth 26-subcarrier RUs **6202** to **6240** having pilot tone positions at the same potential pilot tone positions as the first to eighteenth 26-subcarrier RU **5902** to **5940** of FIG. **59A**, respectively.

[**0524**] FIG. **62** shows first to eighth 52-subcarrier RUs **6242** to **6258** having pilot tone positions at the same potential pilot tone positions as the first to eighth 52-subcarrier RUs **5942** to **5958** of FIG. **59A**, respectively.

[**0525**] FIG. **62** further shows a first 106-subcarrier RU **6262** having pilot tone positions at potential pilot tone positions f2, f4, f6, and f8, a second 106-subcarrier RU **6264** having pilot tone positions at potential pilot tone positions f11, f13, f15, and f17, a third 106-subcarrier RU **6266** having pilot tone positions at potential pilot tone positions f20, f22, f24, and f26, and a fourth 106-subcarrier RU **6268** having pilot tone positions at potential pilot tone positions f29, f31, f33, and f35.

[**0526**] FIG. **62** further shows a first 242-subcarrier RU **6272** having pilot tone positions at potential pilot tone positions f2, f4, f6, f8, f11, f13, f15, and f17, a second 242-subcarrier RU **6274** having pilot tone positions at potential pilot tone positions f20, f22, f24, f26, f29, f31, f33, and f35, and a 484-subcarrier RU **6276** having pilot tone positions at potential pilot tone positions f2, f4, f6, f8, f11, f13, f15, f17, f20, f22, f24, f26, f29, f31, f33, and f35.

[**0527**] Each of the 52-, 106-, 242-, and 484-subcarrier RUs in FIG. **62** has pilot tone positions selected from among the pilot tone positions used by the RUs having fewer subcarriers that occupy the same bandwidth. Furthermore,

the pilot tone positions of FIG. **62** exhibit the mirror symmetry described above for FIG. **59A**.

[**0528**] FIG. **63** illustrates a fifth option for pilot tone positions in Case 2 for a 40 MHz bandwidth. In an embodiment, the fifth option may use the first to thirty-sixth potential pilot tone positions f1 to f36 as shown in Table 9 of FIG. **33B**, but embodiments are not limited thereto.

[**0529**] FIG. **63** shows first to eighteenth 26-subcarrier RUs **6302** to **6340** having pilot tone positions at the same potential pilot tone positions as the first to eighteenth 26-subcarrier RU **5902** to **5940** of FIG. **59A**, respectively.

[**0530**] FIG. **63** shows first to eighth 52-subcarrier RUs **6342** to **6358** having pilot tone positions at the same potential pilot tone positions as the first to eighth 52-subcarrier RUs **5942** to **5958** of FIG. **59A**, respectively.

[**0531**] FIG. **63** further shows a first 108-subcarrier RU **6362** having pilot tone positions at potential pilot tone positions f1, f3, f4, f5, f6, and f8, a second 108-subcarrier RU **6364** having pilot tone positions at potential pilot tone positions f11, f13, f14, f15, f16, and f18, a third 108-subcarrier RU **6366** having pilot tone positions at potential pilot tone positions f19, f21, f22, f23, f24, and f26, and a fourth 108-subcarrier RU **6368** having pilot tone positions at potential pilot tone positions f29, f31, f32, f33, f34, and f36.

[**0532**] FIG. **63** further shows a first 242-subcarrier RU **6372** having pilot tone positions at potential pilot tone positions f1, f3, f6, f8, f11, f13, f16, and f18, a second 242-subcarrier RU **6374** having pilot tone positions at potential pilot tone positions f19, f21, f24, f26, f29, f31, f34, and f36, and a 484-subcarrier RU **6376** having pilot tone positions at potential pilot tone positions f1, f3, f6, f8, f11, f13, f16, f18, f19, f21, f24, f26, f29, f31, f34, and f36.

[**0533**] Each of the 52-, 106-, 242-, and 484-subcarrier RUs in FIG. **63** has pilot tone positions selected from among the pilot tone positions used by the RUs having fewer subcarriers that occupy the same bandwidth. Furthermore, the pilot tone positions of FIG. **63** exhibit the mirror symmetry described above for FIG. **59A**.

[**0534**] FIG. **64** illustrates a sixth option for pilot tone positions in Case 2 for a 40 MHz bandwidth. In an embodiment, the sixth option may use the first to thirty-sixth potential pilot tone positions f1 to f36 as shown in Table 9 of FIG. **33B**, but embodiments are not limited thereto.

[**0535**] FIG. **64** shows first to eighteenth 26-subcarrier RUs **6402** to **6440** having pilot tone positions at the same potential pilot tone positions as the first to eighteenth 26-subcarrier RU **5902** to **5940** of FIG. **59A**, respectively.

[**0536**] FIG. **64** shows first to eighth 52-subcarrier RUs **6442** to **6458** having pilot tone positions at the same potential pilot tone positions as the first to eighth 52-subcarrier RUs **5942** to **5958** of FIG. **59A**, respectively.

[**0537**] FIG. **64** further shows a first 108-subcarrier RU **6462** having pilot tone positions at potential pilot tone positions f1, f3, f4, f5, f6, and f8, a second 108-subcarrier RU **6464** having pilot tone positions at potential pilot tone positions f11, f13, f14, f15, f16, and f18, a third 108-subcarrier RU **6466** having pilot tone positions at potential pilot tone positions f19, f21, f22, f23, f24, and f26, and a fourth 108-subcarrier RU **6468** having pilot tone positions at potential pilot tone positions f29, f31, f32, f33, f34, and f36.

[**0538**] FIG. **64** further shows a first 242-subcarrier RU **6472** having pilot tone positions at potential pilot tone positions f1, f4, f5, f8, f11, f14, f15, and f18, a second 242-subcarrier RU **6474** having pilot tone positions at

potential pilot tone positions f19, f22, f23, f26, f29, f32, f33, and f36, and a 484-subcarrier RU **6476** having pilot tone positions at potential pilot tone positions f1, f4, f5, f8, f11, f14, f15, f18, f19, f22, f23, f26, f29, f32, f33, and f36.

[0539] Each of the 52-, 106-, 242-, and 484-subcarrier RUs in FIG. **64** has pilot tone positions selected from among the pilot tone positions used by the RUs having fewer subcarriers that occupy the same bandwidth. Furthermore, the pilot tone positions of FIG. **64** exhibit the mirror symmetry described above for FIG. **59A**.

[0540] FIG. **65** illustrates a seventh option for pilot tone positions in Case 2 for a 40 MHz bandwidth. In an embodiment, the seventh option may use the first to thirty-sixth potential pilot tone positions f1 to f36 as shown in Table 9 of FIG. **33B**, but embodiments are not limited thereto.

[0541] FIG. **65** shows first to eighteenth 26-subcarrier RUs **6502** to **6540** having pilot tone positions at the same potential pilot tone positions as the first to eighteenth 26-subcarrier RU **5902** to **5940** of FIG. **59A**, respectively.

[0542] FIG. **65** shows first to eighth 52-subcarrier RUs **6542** to **6558** having pilot tone positions at the same potential pilot tone positions as the first to eighth 52-subcarrier RUs **5942** to **5958** of FIG. **59A**, respectively.

[0543] FIG. **65** further shows a first 108-subcarrier RU **6562** having pilot tone positions at potential pilot tone positions f1, f2, f4, f5, f7, and f8, a second 108-subcarrier RU **6564** having pilot tone positions at potential pilot tone positions f11, f12, f14, f15, f17, and f18, a third 108-subcarrier RU **6566** having pilot tone positions at potential pilot tone positions f19, f20, f22, f23, f25, and f26, and a fourth 108-subcarrier RU **6568** having pilot tone positions at potential pilot tone positions f29, f30, f32, f33, f35, and f36.

[0544] FIG. **65** further shows a first 242-subcarrier RU **6572** having pilot tone positions at potential pilot tone positions f1, f4, f5, f8, f11, f14, f15, and f18, a second 242-subcarrier RU **6574** having pilot tone positions at potential pilot tone positions f19, f22, f23, f26, f29, f32, f33, and f36, and a 484-subcarrier RU **6576** having pilot tone positions at potential pilot tone positions f1, f4, f5, f8, f11, f14, f15, f18, f19, f22, f23, f26, f29, f32, f33, and f36.

[0545] Each of the 52-, 106-, 242-, and 484-subcarrier RUs in FIG. **65** has pilot tone positions selected from among the pilot tone positions used by the RUs having fewer subcarriers that occupy the same bandwidth. Furthermore, the pilot tone positions of FIG. **65** exhibit the mirror symmetry described above for FIG. **59A**.

[0546] FIGS. **66** to **78** represent example embodiments of the relative pilot tone positions within the 52 subcarrier RU for different cases and options. The pilot tone positions shown in FIGS. **66** to **78** can be used in both Design A and B, although it was drawn to represent an example of the nested pilot tone positions (i.e. design B) for the 52 subcarrier RUs.

[0547] In FIGS. **66** to **78**, hash marks along the horizontal access correspond to subcarriers that respectively do not correspond to subcarriers having energy in a 2xHE-LTF. Upward pointing arrows along the horizontal access respectively correspond to subcarriers that correspond to the subcarriers having energy in the 2xHE-LTF.

[0548] FIG. **66** illustrates an option for pilot tone positions in Case 1, according to embodiments. FIG. **66** can be interpreted as illustrating two embodiments, according to whether a reference subcarrier index f_0 is even or odd.

[0549] FIG. **66** illustrates a first embodiment including a 52-subcarrier RU **6610** being an even RU and having pilot tone positions such as may be used with an even mapping of a HE-LTF sequence in a 2xLTF design, wherein a reference subcarrier index f_0 has a value equal to $2 \times N$, where N is an integer. FIG. **66** also illustrates pilot tone positions of a first 26-subcarrier RU **6600A** and a second 26-subcarrier RU **6600B** that occupy a plurality of subcarriers occupied by the 52-subcarrier RU **6610** and that would be even and odd RUs, respectively, in the first embodiment.

[0550] FIG. **66** illustrates a second embodiment including a 52-subcarrier RU **6610** being an odd RU and having pilot tone positions such as may be used with an odd mapping of a HE-LTF sequence in a 2xLTF design, wherein the reference subcarrier index f_0 has a value equal to $2 \times N + 1$, where N is an integer. FIG. **66** also illustrates pilot tone positions of a first 26-subcarrier RU **6600A** and a second 26-subcarrier RU **6600B** that occupy a plurality of subcarriers occupied by the 52-subcarrier RU **6610** and that would be odd and even RUs, respectively, in the second embodiment.

[0551] In FIG. **66**, a lowest-indexed subcarrier of the 52-subcarrier RU **6610** is aligned with a lowest-indexed subcarrier of the first 26-subcarrier RU **6600A**. A null or reserved subcarrier **6620** is disposed between the first and second 26-subcarrier RUs **6600A** and **6600B**.

[0552] The first 26-subcarrier RU **6600A** includes first and second pilot tone positions **6602** and **6604**. The first pilot tone position **6602** corresponds to a subcarrier spaced 6 subcarriers away from the lowest-indexed subcarrier of the first 26-subcarrier RU **6600A**. The second pilot tone position **6604** corresponds to a subcarrier separated by 12 subcarriers from the first pilot tone position **6602** and spaced 6 subcarriers away from a highest-indexed subcarrier of the first 26-subcarrier RU **6600A**.

[0553] The second 26-subcarrier RU **6600B** includes third and fourth pilot tone positions **6606** and **6608**. The third pilot tone position **6606** corresponds to a subcarrier spaced 6 subcarriers away from a lowest-indexed subcarrier of the second 26-subcarrier RU **6600B**. The fourth pilot tone position **6608** corresponds to a subcarrier separated by 12 subcarriers from the first pilot tone position **6606** and spaced 6 subcarriers away from a highest-indexed subcarrier of the second 26-subcarrier RU **6600B**.

[0554] The 52-subcarrier RU **6610** includes fifth, sixth, seventh, and eighth pilot tone positions **6612**, **6614**, **6616**, and **6618**. The fifth, sixth, seventh, and eighth pilot tone positions **6612**, **6614**, **6616**, and **6618** of the 52-subcarrier RU **6610** respectively correspond to the first, second, third, and fourth pilot tone positions **6602**, **6604**, **6606**, and **6608** of the first and second 26-subcarrier RUs **6600A** and **6600B**.

[0555] The fifth pilot tone position **6612** corresponds to a subcarrier spaced 6 subcarriers away from the lowest-indexed subcarrier of the 52-subcarrier RU **6610**. The sixth pilot tone position **6614** corresponds to a subcarrier separated by 12 subcarriers from the fifth pilot tone position **6612**. The seventh pilot tone position **6614** corresponds to a subcarrier separated by 13 subcarriers from the sixth pilot tone position **6612**. The eighth pilot tone position **6618** corresponds to a subcarrier separated by 12 subcarriers from the seventh pilot tone position **6616** and spaced 5 subcarriers away from a highest-indexed subcarrier of the 52-subcarrier RU **6610**.

[0556] FIG. **66** illustrates mirror symmetric pilot tone positions between the first 26-subcarrier RU **6600A** (which

may be odd or even) and the second 26-subcarrier RU **6600B** (which may be even or odd, respectively). FIG. **66** also illustrates a nested design in which the 52-subcarrier RU **6610** uses the same pilot tone positions as the first and second RUs **6600A** and **6600B**, but embodiments are not limited thereto.

[**0557**] FIG. **67** illustrates another option for pilot tone positions in Case 1, according to embodiments. FIG. **67** can be interpreted as illustrating two embodiments, according to whether a reference subcarrier index f_0 is even or odd.

[**0558**] FIG. **67** illustrates a first embodiment including a 52-subcarrier RU **6710** being an even RU and having pilot tone positions such as may be used with an even mapping of a HE-LTF sequence in a $2 \times$ LTF design, wherein a reference subcarrier index f_0 has a value equal to $2 \times N$, where N is an integer. FIG. **67** also illustrates pilot tone positions of a first 26-subcarrier RU **6700A** and a second 26-subcarrier RU **6700B** that occupy a plurality of subcarriers occupied by the 52-subcarrier RU **6710** and that would be odd and even RUs, respectively, in the first embodiment.

[**0559**] FIG. **67** illustrates a second embodiment including a 52-subcarrier RU **6710** being an odd RU and having pilot tone positions such as may be used with an odd mapping of a HE-LTF sequence in a $2 \times$ LTF design, wherein the reference subcarrier index f_0 has a value equal to $2 \times N + 1$, where N is an integer. FIG. **67** also illustrates pilot tone positions of a first 26-subcarrier RU **6700A** and a second 26-subcarrier RU **6700B** that occupy a plurality of subcarriers occupied by the 52-subcarrier RU **6710** and that would be even and odd RUs, respectively, in the second embodiment.

[**0560**] In FIG. **67**, a highest-indexed subcarrier of the 52-subcarrier RU **6710** is aligned with a highest-indexed subcarrier of the second 26-subcarrier RU **6700B**. A null or reserved subcarrier **6720** is disposed between the first and second 26-subcarrier RUs **6700A** and **6700B**.

[**0561**] The first 26-subcarrier RU **6700A** includes first and second pilot tone positions **6702** and **6704**. The first pilot tone position **6702** corresponds to a subcarrier spaced 6 subcarriers away from a lowest-indexed subcarrier of the first 26-subcarrier RU **6700A**. The second pilot tone position **6704** corresponds to a subcarrier separated by 12 subcarriers from the first pilot tone position **6702** and spaced 6 subcarriers away from a highest-indexed subcarrier of the first 26-subcarrier RU **6700A**.

[**0562**] The second 26-subcarrier RU **6700B** includes third and fourth pilot tone positions **6706** and **6708**. The third pilot tone position **6706** corresponds to a subcarrier spaced 6 subcarriers away from a lowest-indexed subcarrier of the second 26-subcarrier RU **6700B**. The fourth pilot tone position **6708** corresponds to a subcarrier separated by 12 subcarriers from the first pilot tone position **6706** and spaced 6 subcarriers away from the highest-indexed subcarrier of the second 26-subcarrier RU **6700B**.

[**0563**] The 52-subcarrier RU **6710** includes fifth, sixth, seventh, and eighth pilot tone positions **6712**, **6714**, **6716**, and **6718**. The fifth, sixth, seventh, and eighth pilot tone positions **6712**, **6714**, **6716**, and **6718** of the 52-subcarrier RU **6710** respectively correspond to the first, second, third, and fourth pilot tone positions **6702**, **6704**, **6706**, and **6708** of the first and second 26-subcarrier RUs **6700A** and **6700B**.

[**0564**] The fifth pilot tone position **6712** corresponds to a subcarrier spaced 5 subcarriers away from a lowest-indexed subcarrier of the 52-subcarrier RU **6710**. The sixth pilot tone position **6714** corresponds to a subcarrier separated by 12

subcarriers from the fifth pilot tone position **6712**. The seventh pilot tone position **6714** corresponds to a subcarrier separated by 13 subcarriers from the sixth pilot tone position **6712**. The eighth pilot tone position **6718** corresponds to a subcarrier separated by 12 subcarriers from the seventh pilot tone position **6716** and spaced 6 subcarriers away from the highest-indexed subcarrier of the 52-subcarrier RU **6710**.

[**0565**] FIG. **67** illustrates mirror symmetric pilot tone positions between the first 26-subcarrier RU **6700A** (which may be odd or even) and the second 26-subcarrier RU **6700B** (which may be even or odd, respectively). FIG. **67** also illustrates a nested design in which the 52-subcarrier RU **6710** uses the same pilot tone positions as the first and second RUs **6700A** and **6700B**, but embodiments are not limited thereto.

[**0566**] FIG. **68** illustrates another option for pilot tone positions in Case 1, according to embodiments. FIG. **68** can be interpreted as illustrating two embodiments, according to whether a reference subcarrier index f_0 is even or odd.

[**0567**] FIG. **68** illustrates a first embodiment including a 52-subcarrier RU **6810** being an even RU and having pilot tone positions such as may be used with an odd mapping of a HE-LTF sequence in a $2 \times$ LTF design, wherein a reference subcarrier index f_0 has a value equal to $2 \times N$, where N is an integer. FIG. **68** also illustrates pilot tone positions of a first 26-subcarrier RU **6800A** and a second 26-subcarrier RU **6800B** that occupy a plurality of subcarriers occupied by the 52-subcarrier RU **6810** and that would be even and odd RUs, respectively, in the first embodiment.

[**0568**] FIG. **68** may also be seen illustrating a second embodiment including a 52-subcarrier RU **6810** being an odd RU and having pilot tone positions such as may be used with an even mapping of a HE-LTF sequence in a $2 \times$ LTF design, wherein the reference subcarrier index f_0 has a value equal to $2 \times N + 1$, where N is an integer. FIG. **68** also illustrates pilot tone positions of a first 26-subcarrier RU **6800A** and a second 26-subcarrier RU **6800B** that occupy a plurality of subcarriers occupied by the 52-subcarrier RU **6810** and that would be odd and even RUs, respectively, in the second embodiment.

[**0569**] In FIG. **68**, a lowest-indexed subcarrier of the 52-subcarrier RU **6810** is aligned with a lowest-indexed subcarrier of the first 26-subcarrier RU **6800A**. A null or reserved subcarrier **6820** is disposed between the first and second 26-subcarrier RUs **6800A** and **6800B**.

[**0570**] The first 26-subcarrier RU **6800A** includes first and second pilot tone positions **6802** and **6804**. The first pilot tone position **6802** corresponds to a subcarrier spaced 6 subcarriers away from the lowest-indexed subcarrier of the first 26-subcarrier RU **6800A**. The second pilot tone position **6804** corresponds to a subcarrier separated by 12 subcarriers from the first pilot tone position **6802** and spaced 6 subcarriers away from a highest-indexed subcarrier of the first 26-subcarrier RU **6800A**.

[**0571**] The second 26-subcarrier RU **6800B** includes third and fourth pilot tone positions **6806** and **6808**. The third pilot tone position **6806** corresponds to a subcarrier spaced 6 subcarriers away from a lowest-indexed subcarrier of the second 26-subcarrier RU **6800B**. The fourth pilot tone position **6808** corresponds to a subcarrier separated by 12 subcarriers from the first pilot tone position **6806** and spaced 6 subcarriers away from a highest-indexed subcarrier of the second 26-subcarrier RU **6800B**.

[0572] The 52-subcarrier RU **6810** includes fifth, sixth, seventh, and eighth pilot tone positions **6812**, **6814**, **6816**, and **6818**. The fifth, sixth, seventh, and eighth pilot tone positions **6812**, **6814**, **6816**, and **6818** of the 52-subcarrier RU **6810** respectively correspond to the first, second, third, and fourth pilot tone positions **6802**, **6804**, **6806**, and **6808** of the first and second 26-subcarrier RUs **6800A** and **6800B**.

[0573] The fifth pilot tone position **6812** corresponds to a subcarrier spaced 6 subcarriers away from the lowest-indexed subcarrier of the 52-subcarrier RU **6810**. The sixth pilot tone position **6814** corresponds to a subcarrier separated by 12 subcarriers from the fifth pilot tone position **6812**. The seventh pilot tone position **6814** corresponds to a subcarrier separated by 13 subcarriers from the sixth pilot tone position **6812**. The eighth pilot tone position **6818** corresponds to a subcarrier separated by 12 subcarriers from the seventh pilot tone position **6816** and spaced 5 subcarriers away from a highest-indexed subcarrier of the 52-subcarrier RU **6810**.

[0574] FIG. **68** illustrates mirror symmetric pilot tone positions between the first 26-subcarrier RU **6800A** (which may be odd or even) and the second 26-subcarrier RU **6800B** (which may be even or odd, respectively). FIG. **68** also illustrates a nested design in which the 52-subcarrier RU **6810** uses the same pilot tone positions as the first and second RUs **6800A** and **6800B**, but embodiments are not limited thereto.

[0575] FIG. **69** illustrates another option for pilot tone positions in Case 1, according to embodiments. FIG. **69** can be interpreted as illustrating two embodiments, according to whether a reference subcarrier index f_0 is even or odd.

[0576] FIG. **69** illustrates a first embodiment including a 52-subcarrier RU **6910** being an even RU and having pilot tone positions such as may be used with an odd mapping of a HE-LTF sequence in a $2 \times \text{LTF}$ design, wherein a reference subcarrier index f_0 has a value equal to $2 \times N$, where N is an integer. FIG. **69** also illustrates pilot tone positions of a first 26-subcarrier RU **6900A** and a second 26-subcarrier RU **6900B** that occupy a plurality of subcarriers occupied by the 52-subcarrier RU **6910** and that would be odd and even RUs, respectively, in the first embodiment.

[0577] FIG. **69** illustrates a second embodiment including a 52-subcarrier RU **6910** being an odd RU and having pilot tone positions such as may be used with an even mapping of a HE-LTF sequence in a $2 \times \text{LTF}$ design, wherein the reference subcarrier index f_0 has a value equal to $2 \times N + 1$, where N is an integer. FIG. **69** also illustrates pilot tone positions of a first 26-subcarrier RU **6900A** and a second 26-subcarrier RU **6900B** that occupy a plurality of subcarriers occupied by the 52-subcarrier RU **6910** and that would be even and odd RUs, respectively, in the second embodiment.

[0578] In FIG. **69**, a highest-indexed subcarrier of the 52-subcarrier RU **6910** is aligned with a highest-indexed subcarrier of the second 26-subcarrier RU **6900B**. A null or reserved subcarrier **6920** is disposed between the first and second 26-subcarrier RUs **6900A** and **6900B**.

[0579] The first 26-subcarrier RU **6900A** includes first and second pilot tone positions **6902** and **6904**. The first pilot tone position **6902** corresponds to a subcarrier spaced 6 subcarriers away from a lowest-indexed subcarrier of the first 26-subcarrier RU **6900A**. The second pilot tone position **6904** corresponds to a subcarrier separated by 12 subcarriers

from the first pilot tone position **6902** and spaced 6 subcarriers away from a highest-indexed subcarrier of the first 26-subcarrier RU **6900A**.

[0580] The second 26-subcarrier RU **6900B** includes third and fourth pilot tone positions **6906** and **6908**. The third pilot tone position **6906** corresponds to a subcarrier spaced 6 subcarriers away from a lowest-indexed subcarrier of the second 26-subcarrier RU **6900B**. The fourth pilot tone position **6908** corresponds to a subcarrier separated by 12 subcarriers from the first pilot tone position **6906** and spaced 6 subcarriers away from the highest-indexed subcarrier of the second 26-subcarrier RU **6900B**.

[0581] The 52-subcarrier RU **6910** includes fifth, sixth, seventh, and eighth pilot tone positions **6912**, **6914**, **6916**, and **6918**. The fifth, sixth, seventh, and eighth pilot tone positions **6912**, **6914**, **6916**, and **6918** of the 52-subcarrier RU **6910** respectively correspond to the first, second, third, and fourth pilot tone positions **6902**, **6904**, **6906**, and **6908** of the first and second 26-subcarrier RUs **6900A** and **6900B**.

[0582] The fifth pilot tone position **6912** corresponds to a subcarrier spaced 5 subcarriers away from a lowest-indexed subcarrier of the 52-subcarrier RU **6910**. The sixth pilot tone position **6914** corresponds to a subcarrier separated by 12 subcarriers from the fifth pilot tone position **6912**. The seventh pilot tone position **6914** corresponds to a subcarrier separated by 13 subcarriers from the sixth pilot tone position **6912**. The eighth pilot tone position **6918** corresponds to a subcarrier separated by 12 subcarriers from the seventh pilot tone position **6916** and spaced 6 subcarriers away from the highest-indexed subcarrier of the 52-subcarrier RU **6910**.

[0583] FIG. **69** illustrates mirror symmetric pilot tone positions between the first 26-subcarrier RU **6900A** (which may be odd or even) and the second 26-subcarrier RU **6900B** (which may be even or odd, respectively). FIG. **69** also illustrates a nested design in which the 52-subcarrier RU **6910** uses the same pilot tone positions as the first and second RUs **6900A** and **6900B**, but embodiments are not limited thereto.

[0584] FIG. **70** illustrates another option for pilot tone positions in Case 1, according to embodiments. FIG. **70** can be interpreted as illustrating two embodiments, according to whether a reference subcarrier index f_0 is even or odd.

[0585] FIG. **70** illustrates a first embodiment including a 52-subcarrier RU **7010** being an even RU and having pilot tone positions such as may be used with an even mapping of a HE-LTF sequence in a $2 \times \text{LTF}$ design, wherein a reference subcarrier index f_0 has a value equal to $2 \times N$, where N is an integer. FIG. **70** also illustrates pilot tone positions of a first 26-subcarrier RU **7000A** and a second 26-subcarrier RU **7000B** that occupy a plurality of subcarriers occupied by the 52-subcarrier RU **7010** and that would be odd and even RUs, respectively, in the first embodiment.

[0586] FIG. **70** illustrates a second embodiment including a 52-subcarrier RU **7010** being an odd RU and having pilot tone positions such as may be used with an odd mapping of a HE-LTF sequence in a $2 \times \text{LTF}$ design, wherein the reference subcarrier index f_0 has a value equal to $2 \times N + 1$, where N is an integer. FIG. **70** also illustrates pilot tone positions of a first 26-subcarrier RU **7000A** and a second 26-subcarrier RU **7000B** that occupy a plurality of subcarriers occupied by the 52-subcarrier RU **7010** and that would be even and odd RUs, respectively, in the second embodiment.

[0587] In FIG. **70**, a highest-indexed subcarrier of the 52-subcarrier RU **7010** is aligned with a highest-indexed

subcarrier of the second 26-subcarrier RU 7000B. A null or reserved subcarrier 7020 is disposed between the first and second 26-subcarrier RUs 7000A and 7000B.

[0588] The first 26-subcarrier RU 7000A includes first and second pilot tone positions 7002 and 7004. The first pilot tone position 7002 corresponds to a subcarrier spaced 5 subcarriers away from a lowest-indexed subcarrier of the first 26-subcarrier RU 7000A. The second pilot tone position 7004 corresponds to a subcarrier separated by 13 subcarriers from the first pilot tone position 7002 and spaced 6 subcarriers away from a highest-indexed subcarrier of the first 26-subcarrier RU 7000A.

[0589] The second 26-subcarrier RU 7000B includes third and fourth pilot tone positions 7006 and 7008. The third pilot tone position 7006 corresponds to a subcarrier spaced 6 subcarriers away from a lowest-indexed subcarrier of the second 26-subcarrier RU 7000B. The fourth pilot tone position 7008 corresponds to a subcarrier separated by 13 subcarriers from the first pilot tone position 7006 and spaced 5 subcarriers away from the highest-indexed subcarrier of the second 26-subcarrier RU 7000B.

[0590] The 52-subcarrier RU 7010 includes fifth, sixth, seventh, and eighth pilot tone positions 7012, 7014, 7016, and 7018. The fifth, sixth, seventh, and eighth pilot tone positions 7012, 7014, 7016, and 7018 of the 52-subcarrier RU 7010 respectively correspond to the first, second, third, and fourth pilot tone positions 7002, 7004, 7006, and 7008 of the first and second 26-subcarrier RUs 7000A and 7000B.

[0591] The fifth pilot tone position 7012 corresponds to a subcarrier spaced 4 subcarriers away from the lowest-indexed subcarrier of the 52-subcarrier RU 7010. The sixth pilot tone position 7014 corresponds to a subcarrier separated by 13 subcarriers from the fifth pilot tone position 7012. The seventh pilot tone position 7014 corresponds to a subcarrier separated by 13 subcarriers from the sixth pilot tone position 7012. The eighth pilot tone position 7018 corresponds to a subcarrier separated by 13 subcarriers from the seventh pilot tone position 7016 and spaced 5 subcarriers away from a highest-indexed subcarrier of the 52-subcarrier RU 7010.

[0592] FIG. 70 illustrates mirror symmetric pilot tone positions between the first 26-subcarrier RU 7000A (which may be odd or even) and the second 26-subcarrier RU 7000B (which may be even or odd, respectively). FIG. 70 also illustrates a nested design in which the 52-subcarrier RU 7010 uses the same pilot tone positions as the first and second RUs 7000A and 7000B, but embodiments are not limited thereto.

[0593] FIG. 71 illustrates another option for pilot tone positions in Case 1, according to embodiments. FIG. 71 can be interpreted as illustrating two embodiments, according to whether a reference subcarrier index f_0 is even or odd.

[0594] FIG. 71 illustrates a first embodiment including a 52-subcarrier RU 7110 being an even RU and having pilot tone positions such as may be used with an even mapping of a HE-LTF sequence in a $2 \times$ LTF design, wherein a reference subcarrier index f_0 has a value equal to $2 \times N$, where N is an integer. FIG. 71 also illustrates pilot tone positions of a first 26-subcarrier RU 7100A and a second 26-subcarrier RU 7100B that occupy a plurality of subcarriers occupied by the 52-subcarrier RU 7110 and that would be even and odd RUs, respectively, in the first embodiment.

[0595] FIG. 71 illustrates a second embodiment including a 52-subcarrier RU 7110 being an odd RU and having pilot

tone positions such as may be used with an odd mapping of a HE-LTF sequence in a $2 \times$ LTF design, wherein the reference subcarrier index f_0 has a value equal to $2 \times N + 1$, where N is an integer. FIG. 71 also illustrates pilot tone positions of a first 26-subcarrier RU 7100A and a second 26-subcarrier RU 7100B that occupy a plurality of subcarriers occupied by the 52-subcarrier RU 7110 and that would be odd and even RUs, respectively, in the second embodiment.

[0596] In FIG. 71, a lowest-indexed subcarrier of the 52-subcarrier RU 7110 is aligned with a lowest-indexed subcarrier of the first 26-subcarrier RU 7100A. A null or reserved subcarrier 7120 is disposed between the first and second 26-subcarrier RUs 7100A and 7100B.

[0597] The first 26-subcarrier RU 7100A includes first and second pilot tone positions 7102 and 7104. The first pilot tone position 7102 corresponds to a subcarrier spaced 6 subcarriers away from the lowest-indexed subcarrier of the first 26-subcarrier RU 7100A. The second pilot tone position 7104 corresponds to a subcarrier separated by 13 subcarriers from the first pilot tone position 7102 and spaced 5 subcarriers away from a highest-indexed subcarrier of the first 26-subcarrier RU 7100A.

[0598] The second 26-subcarrier RU 7100B includes third and fourth pilot tone positions 7106 and 7108. The third pilot tone position 7106 corresponds to a subcarrier spaced 5 subcarriers away from a lowest-indexed subcarrier of the second 26-subcarrier RU 7100B. The fourth pilot tone position 7108 corresponds to a subcarrier separated by 13 subcarriers from the first pilot tone position 7106 and spaced 6 subcarriers away from the highest-indexed subcarrier of the second 26-subcarrier RU 7100B.

[0599] The 52-subcarrier RU 7110 includes fifth, sixth, seventh, and eighth pilot tone positions 7112, 7114, 7116, and 7118. The fifth, sixth, seventh, and eighth pilot tone positions 7112, 7114, 7116, and 7118 of the 52-subcarrier RU 7110 respectively correspond to the first, second, third, and fourth pilot tone positions 7102, 7104, 7106, and 7108 of the first and second 26-subcarrier RUs 7100A and 7100B.

[0600] The fifth pilot tone position 7112 corresponds to a subcarrier spaced 6 subcarriers away from the lowest-indexed subcarrier of the 52-subcarrier RU 7110. The sixth pilot tone position 7114 corresponds to a subcarrier separated by 13 subcarriers from the fifth pilot tone position 7112. The seventh pilot tone position 7114 corresponds to a subcarrier separated by 11 subcarriers from the sixth pilot tone position 7112. The eighth pilot tone position 7118 corresponds to a subcarrier separated by 13 subcarriers from the seventh pilot tone position 7116 and spaced 5 subcarriers away from a highest-indexed subcarrier of the 52-subcarrier RU 7110.

[0601] FIG. 71 illustrates mirror symmetric pilot tone positions between the first 26-subcarrier RU 7100A (which may be odd or even) and the second 26-subcarrier RU 7100B (which may be even or odd, respectively). FIG. 71 also illustrates a nested design in which the 52-subcarrier RU 7110 uses the same pilot tone positions as the first and second RUs 7100A and 7100B, but embodiments are not limited thereto.

[0602] FIG. 72 illustrates another option for pilot tone positions in Case 1, according to embodiments. FIG. 72 can be interpreted as illustrating two embodiments, according to whether a reference subcarrier index f_0 is even or odd.

[0603] FIG. 72 illustrates a first embodiment including a 52-subcarrier RU 7210 being an even RU and having pilot

tone positions such as may be used with an even mapping of a HE-LTF sequence in a $2 \times$ LTF design, wherein a reference subcarrier index f_0 has a value equal to $2 \times N$, where N is an integer. FIG. 72 also illustrates pilot tone positions of a first 26-subcarrier RU 7200A and a second 26-subcarrier RU 7200B that occupy a plurality of subcarriers occupied by the 52-subcarrier RU 7210 and that would be odd and even RUs, respectively, in the first embodiment.

[0604] FIG. 72 illustrates a second embodiment including a 52-subcarrier RU 7210 being an odd RU and having pilot tone positions such as may be used with an odd mapping of a HE-LTF sequence in a $2 \times$ LTF design, wherein the reference subcarrier index f_0 has a value equal to $2 \times N + 1$, where N is an integer. FIG. 72 also illustrates pilot tone positions of a first 26-subcarrier RU 7200A and a second 26-subcarrier RU 7200B that occupy a plurality of subcarriers occupied by the 52-subcarrier RU 7210 and that would be even and odd RUs, respectively, in the second embodiment.

[0605] In FIG. 72, a highest-indexed subcarrier of the 52-subcarrier RU 7210 is aligned with a highest-indexed subcarrier of the second 26-subcarrier RU 7200B. A null or reserved subcarrier 7220 is disposed between the first and second 26-subcarrier RUs 7200A and 7200B.

[0606] The first 26-subcarrier RU 7200A includes first and second pilot tone positions 7202 and 7204. The first pilot tone position 7202 corresponds to a subcarrier spaced 7 subcarriers away from a lowest-indexed subcarrier of the first 26-subcarrier RU 7200A. The second pilot tone position 7204 corresponds to a subcarrier separated by 11 subcarriers from the first pilot tone position 7202 and spaced 6 subcarriers away from a highest-indexed subcarrier of the first 26-subcarrier RU 7200A.

[0607] The second 26-subcarrier RU 7200B includes third and fourth pilot tone positions 7206 and 7208. The third pilot tone position 7206 corresponds to a subcarrier spaced 6 subcarriers away from a lowest-indexed subcarrier of the second 26-subcarrier RU 7200B. The fourth pilot tone position 7208 corresponds to a subcarrier separated by 11 subcarriers from the first pilot tone position 7206 and spaced 7 subcarriers away from the highest-indexed subcarrier of the second 26-subcarrier RU 7200B.

[0608] The 52-subcarrier RU 7210 includes fifth, sixth, seventh, and eighth pilot tone positions 7212, 7214, 7216, and 7218. The fifth, sixth, seventh, and eighth pilot tone positions 7212, 7214, 7216, and 7218 of the 52-subcarrier RU 7210 respectively correspond to the first, second, third, and fourth pilot tone positions 7202, 7204, 7206, and 7208 of the first and second 26-subcarrier RUs 7200A and 7200B.

[0609] The fifth pilot tone position 7212 corresponds to a subcarrier spaced 6 subcarriers away from the lowest-indexed subcarrier of the 52-subcarrier RU 7210. The sixth pilot tone position 7214 corresponds to a subcarrier separated by 11 subcarriers from the fifth pilot tone position 7212. The seventh pilot tone position 7216 corresponds to a subcarrier separated by 13 subcarriers from the sixth pilot tone position 7212. The eighth pilot tone position 7218 corresponds to a subcarrier separated by 11 subcarriers from the seventh pilot tone position 7216 and spaced 7 subcarriers away from a highest-indexed subcarrier of the 52-subcarrier RU 7210.

[0610] FIG. 72 illustrates mirror symmetric pilot tone positions between the first 26-subcarrier RU 7200A (which may be odd or even) and the second 26-subcarrier RU 7200B (which may be even or odd, respectively). FIG. 72

also illustrates a nested design in which the 52-subcarrier RU 7210 uses the same pilot tone positions as the first and second RUs 7200A and 7200B, but embodiments are not limited thereto.

[0611] FIG. 73 illustrates another option for pilot tone positions in Case 2, according to embodiments. FIG. 73 can be interpreted as illustrating two embodiments, according to whether a reference subcarrier index f_0 is even or odd.

[0612] FIG. 73 illustrates a first embodiment including a 52-subcarrier RU 7310 being an even RU and having pilot tone positions such as may be used with an even mapping of a HE-LTF sequence in a $2 \times$ LTF design, wherein a reference subcarrier index f_0 has a value equal to $2 \times N$, where N is an integer. FIG. 73 also illustrates pilot tone positions of a first 26-subcarrier RU 7300A and a second 26-subcarrier RU 7300B that occupy a plurality of subcarriers occupied by the 52-subcarrier RU 7310 and that would be even RUs in the first embodiment.

[0613] FIG. 73 illustrates a second embodiment including a 52-subcarrier RU 7310 being an odd RU and having pilot tone positions such as may be used with an odd mapping of a HE-LTF sequence in a $2 \times$ LTF design, wherein the reference subcarrier index f_0 has a value equal to $2 \times N + 1$, where N is an integer. FIG. 73 also illustrates pilot tone positions of a first 26-subcarrier RU 7300A and a second 26-subcarrier RU 7300B that occupy a plurality of subcarriers occupied by the 52-subcarrier RU 7310 and that would be odd RUs in the second embodiment.

[0614] In FIG. 73, a lowest-indexed subcarrier of the 52-subcarrier RU 7310 is aligned with a lowest-indexed subcarrier of the first 26-subcarrier RU 7300A and a highest-indexed subcarrier of the 52-subcarrier RU 7310 is aligned with a highest-indexed subcarrier of the second 26-subcarrier RU 7300B.

[0615] The first 26-subcarrier RU 7300A includes first and second pilot tone positions 7302 and 7304. The first pilot tone position 7302 corresponds to a subcarrier spaced 6 subcarriers away from a lowest-indexed subcarrier of the first 26-subcarrier RU 7300A. The second pilot tone position 7304 corresponds to a subcarrier separated by 12 subcarriers from the first pilot tone position 7302 and spaced 6 subcarriers away from a highest-indexed subcarrier of the first 26-subcarrier RU 7300A.

[0616] The second 26-subcarrier RU 7300B includes third and fourth pilot tone positions 7306 and 7308. The third pilot tone position 7306 corresponds to a subcarrier spaced 6 subcarriers away from a lowest-indexed subcarrier of the second 26-subcarrier RU 7300B. The fourth pilot tone position 7308 corresponds to a subcarrier separated by 12 subcarriers from the first pilot tone position 7306 and spaced 6 subcarriers away from the highest-indexed subcarrier of the second 26-subcarrier RU 7300B.

[0617] The 52-subcarrier RU 7310 includes fifth, sixth, seventh, and eighth pilot tone positions 7312, 7314, 7316, and 7318. The fifth, sixth, seventh, and eighth pilot tone positions 7312, 7314, 7316, and 7318 of the 52-subcarrier RU 7310 respectively correspond to the first, second, third, and fourth pilot tone positions 7302, 7304, 7306, and 7308 of the first and second 26-subcarrier RUs 7300A and 7300B.

[0618] The fifth pilot tone position 7312 corresponds to a subcarrier spaced 6 subcarriers away from the lowest-indexed subcarrier of the 52-subcarrier RU 7310. The sixth pilot tone position 7314 corresponds to a subcarrier separated by 12 subcarriers from the fifth pilot tone position

7312. The seventh pilot tone position **7314** corresponds to a subcarrier separated by 12 subcarriers from the sixth pilot tone position **7312**. The eighth pilot tone position **7318** corresponds to a subcarrier separated by 12 subcarriers from the seventh pilot tone position **7316** and spaced 6 subcarriers away from a highest-indexed subcarrier of the 52-subcarrier RU **7310**.

[0619] FIG. 73 illustrates a nested design in which the 52-subcarrier RU **7310** uses the same pilot tone positions as the first and second RUs **7300A** and **7300B**, but embodiments are not limited thereto.

[0620] FIG. 74 illustrates another option for pilot tone positions in Case 2, according to embodiments. FIG. 74 can be interpreted as illustrating two embodiments, according to whether a reference subcarrier index f_0 is even or odd.

[0621] FIG. 74 illustrates a first embodiment including a 52-subcarrier RU **7410** being an even RU and having pilot tone positions such as may be used with an odd mapping of a HE-LTF sequence in a $2 \times$ LTF design, wherein a reference subcarrier index f_0 has a value equal to $2 \times N$, where N is an integer. FIG. 74 also illustrates pilot tone positions of a first 26-subcarrier RU **7400A** and a second 26-subcarrier RU **7400B** that occupy a plurality of subcarriers occupied by the 52-subcarrier RU **7410** and that would be even RUs in the first embodiment.

[0622] FIG. 74 illustrates a second embodiment including a 52-subcarrier RU **7410** being an odd RU and having pilot tone positions such as may be used with an even mapping of a HE-LTF sequence in a $2 \times$ LTF design, wherein the reference subcarrier index f_0 has a value equal to $2 \times N + 1$, where N is an integer. FIG. 74 also illustrates pilot tone positions of a first 26-subcarrier RU **7400A** and a second 26-subcarrier RU **7400B** that occupy a plurality of subcarriers occupied by the 52-subcarrier RU **7410** and that would be odd RUs in the second embodiment.

[0623] In FIG. 74, a lowest-indexed subcarrier of the 52-subcarrier RU **7410** is aligned with a lowest-indexed subcarrier of the first 26-subcarrier RU **7400A** and a highest-indexed subcarrier of the 52-subcarrier RU **7410** is aligned with a highest-indexed subcarrier of the second 26-subcarrier RU **7400B**.

[0624] The first 26-subcarrier RU **7400A** includes first and second pilot tone positions **7402** and **7404**. The first pilot tone position **7402** corresponds to a subcarrier spaced 6 subcarriers away from a lowest-indexed subcarrier of the first 26-subcarrier RU **7400A**. The second pilot tone position **7404** corresponds to a subcarrier separated by 12 subcarriers from the first pilot tone position **7402** and spaced 6 subcarriers away from a highest-indexed subcarrier of the first 26-subcarrier RU **7400A**.

[0625] The second 26-subcarrier RU **7400B** includes third and fourth pilot tone positions **7406** and **7408**. The third pilot tone position **7406** corresponds to a subcarrier spaced 6 subcarriers away from a lowest-indexed subcarrier of the second 26-subcarrier RU **7400B**. The fourth pilot tone position **7408** corresponds to a subcarrier separated by 12 subcarriers from the first pilot tone position **7406** and spaced 6 subcarriers away from the highest-indexed subcarrier of the second 26-subcarrier RU **7400B**.

[0626] The 52-subcarrier RU **7410** includes fifth, sixth, seventh, and eighth pilot tone positions **7412**, **7414**, **7416**, and **7418**. The fifth, sixth, seventh, and eighth pilot tone positions **7412**, **7414**, **7416**, and **7418** of the 52-subcarrier RU **7410** respectively correspond to the first, second, third,

and fourth pilot tone positions **7402**, **7404**, **7406**, and **7408** of the first and second 26-subcarrier RUs **7400A** and **7400B**.

[0627] The fifth pilot tone position **7412** corresponds to a subcarrier spaced 6 subcarriers away from the lowest-indexed subcarrier of the 52-subcarrier RU **7410**. The sixth pilot tone position **7414** corresponds to a subcarrier separated by 12 subcarriers from the fifth pilot tone position **7412**. The seventh pilot tone position **7416** corresponds to a subcarrier separated by 12 subcarriers from the sixth pilot tone position **7412**. The eighth pilot tone position **7418** corresponds to a subcarrier separated by 12 subcarriers from the seventh pilot tone position **7416** and spaced 6 subcarriers away from a highest-indexed subcarrier of the 52-subcarrier RU **7410**.

[0628] FIG. 74 illustrates a nested design in which the 52-subcarrier RU **7410** uses the same pilot tone positions as the first and second RUs **7400A** and **7400B**, but embodiments are not limited thereto.

[0629] FIG. 75 illustrates another option for pilot tone positions in Case 2, according to embodiments. FIG. 75 can be interpreted as illustrating two embodiments, according to whether a reference subcarrier index f_0 is even or odd.

[0630] FIG. 75 illustrates a first embodiment including a 52-subcarrier RU **7510** being an even RU and having pilot tone positions such as may be used with an even mapping of a HE-LTF sequence in a $2 \times$ LTF design, wherein a reference subcarrier index f_0 has a value equal to $2 \times N$, where N is an integer. FIG. 75 also illustrates pilot tone positions of a first 26-subcarrier RU **7500A** and a second 26-subcarrier RU **7500B** that occupy a plurality of subcarriers occupied by the 52-subcarrier RU **7510** and that would be even RUs in the first embodiment.

[0631] FIG. 75 illustrates a second embodiment including a 52-subcarrier RU **7510** being an odd RU and having pilot tone positions such as may be used with an odd mapping of a HE-LTF sequence in a $2 \times$ LTF design, wherein the reference subcarrier index f_0 has a value equal to $2 \times N + 1$, where N is an integer. FIG. 75 also illustrates pilot tone positions of a first 26-subcarrier RU **7500A** and a second 26-subcarrier RU **7500B** that occupy a plurality of subcarriers occupied by the 52-subcarrier RU **7510** and that would be odd RUs in the second embodiment.

[0632] In FIG. 75, a lowest-indexed subcarrier of the 52-subcarrier RU **7510** is aligned with a lowest-indexed subcarrier of the first 26-subcarrier RU **7500A** and a highest-indexed subcarrier of the 52-subcarrier RU **7510** is aligned with a highest-indexed subcarrier of the second 26-subcarrier RU **7500B**.

[0633] The first 26-subcarrier RU **7500A** includes first and second pilot tone positions **7502** and **7504**. The first pilot tone position **7502** corresponds to a subcarrier spaced 6 subcarriers away from a lowest-indexed subcarrier of the first 26-subcarrier RU **7500A**. The second pilot tone position **7504** corresponds to a subcarrier separated by 11 subcarriers from the first pilot tone position **7502** and spaced 7 subcarriers away from a highest-indexed subcarrier of the first 26-subcarrier RU **7500A**.

[0634] The second 26-subcarrier RU **7500B** includes third and fourth pilot tone positions **7506** and **7508**. The third pilot tone position **7506** corresponds to a subcarrier spaced 6 subcarriers away from a lowest-indexed subcarrier of the second 26-subcarrier RU **7500B**. The fourth pilot tone position **7508** corresponds to a subcarrier separated by 11 subcarriers from the first pilot tone position **7506** and spaced

7 subcarriers away from the highest-indexed subcarrier of the second 26-subcarrier RU **7500B**.

[0635] The 52-subcarrier RU **7510** includes fifth, sixth, seventh, and eighth pilot tone positions **7512**, **7514**, **7516**, and **7518**. The fifth, sixth, seventh, and eighth pilot tone positions **7512**, **7514**, **7516**, and **7518** of the 52-subcarrier RU **7510** respectively correspond to the first, second, third, and fourth pilot tone positions **7502**, **7504**, **7506**, and **7508** of the first and second 26-subcarrier RUs **7500A** and **7500B**.

[0636] The fifth pilot tone position **7512** corresponds to a subcarrier spaced 6 subcarriers away from the lowest-indexed subcarrier of the 52-subcarrier RU **7510**. The sixth pilot tone position **7514** corresponds to a subcarrier separated by 11 subcarriers from the fifth pilot tone position **7512**. The seventh pilot tone position **7514** corresponds to a subcarrier separated by 13 subcarriers from the sixth pilot tone position **7512**. The eighth pilot tone position **7518** corresponds to a subcarrier separated by 11 subcarriers from the seventh pilot tone position **7516** and spaced 7 subcarriers away from a highest-indexed subcarrier of the 52-subcarrier RU **7510**.

[0637] FIG. **75** illustrates a nested design in which the 52-subcarrier RU **7510** uses the same pilot tone positions as the first and second RUs **7500A** and **7500B**, but embodiments are not limited thereto.

[0638] FIG. **76** illustrates another option for pilot tone positions in Case 2, according to embodiments. FIG. **76** can be interpreted as illustrating two embodiments, according to whether a reference subcarrier index f_0 is even or odd.

[0639] FIG. **76** illustrates a first embodiment including a 52-subcarrier RU **7610** being an even RU and having pilot tone positions such as may be used with an odd mapping of a HE-LTF sequence in a $2 \times$ LTF design, wherein a reference subcarrier index f_0 has a value equal to $2 \times N$, where N is an integer. FIG. **76** also illustrates pilot tone positions of a first 26-subcarrier RU **7600A** and a second 26-subcarrier RU **7600B** that occupy a plurality of subcarriers occupied by the 52-subcarrier RU **7610** and that would be even RUs in the first embodiment.

[0640] FIG. **76** illustrates a second embodiment including a 52-subcarrier RU **7610** being an odd RU and having pilot tone positions such as may be used with an even mapping of a HE-LTF sequence in a $2 \times$ LTF design, wherein the reference subcarrier index f_0 has a value equal to $2 \times N + 1$, where N is an integer. FIG. **76** also illustrates pilot tone positions of a first 26-subcarrier RU **7600A** and a second 26-subcarrier RU **7600B** that occupy a plurality of subcarriers occupied by the 52-subcarrier RU **7610** and that would be odd RUs in the second embodiment.

[0641] In FIG. **76**, a lowest-indexed subcarrier of the 52-subcarrier RU **7610** is aligned with a lowest-indexed subcarrier of the first 26-subcarrier RU **7600A** and a highest-indexed subcarrier of the 52-subcarrier RU **7610** is aligned with a highest-indexed subcarrier of the second 26-subcarrier RU **7600B**.

[0642] The first 26-subcarrier RU **7600A** includes first and second pilot tone positions **7602** and **7604**. The first pilot tone position **7602** corresponds to a subcarrier spaced 7 subcarriers away from a lowest-indexed subcarrier of the first 26-subcarrier RU **7600A**. The second pilot tone position **7604** corresponds to a subcarrier separated by 11 subcarriers from the first pilot tone position **7602** and spaced 6 subcarriers away from a highest-indexed subcarrier of the first 26-subcarrier RU **7600A**.

[0643] The second 26-subcarrier RU **7600B** includes third and fourth pilot tone positions **7606** and **7608**. The third pilot tone position **7606** corresponds to a subcarrier spaced 7 subcarriers away from a lowest-indexed subcarrier of the second 26-subcarrier RU **7600B**. The fourth pilot tone position **7608** corresponds to a subcarrier separated by 11 subcarriers from the first pilot tone position **7606** and spaced 6 subcarriers away from the highest-indexed subcarrier of the second 26-subcarrier RU **7600B**.

[0644] The 52-subcarrier RU **7610** includes fifth, sixth, seventh, and eighth pilot tone positions **7612**, **7614**, **7616**, and **7618**. The fifth, sixth, seventh, and eighth pilot tone positions **7612**, **7614**, **7616**, and **7618** of the 52-subcarrier RU **7610** respectively correspond to the first, second, third, and fourth pilot tone positions **7602**, **7604**, **7606**, and **7608** of the first and second 26-subcarrier RUs **7600A** and **7600B**.

[0645] The fifth pilot tone position **7612** corresponds to a subcarrier spaced 7 subcarriers away from the lowest-indexed subcarrier of the 52-subcarrier RU **7610**. The sixth pilot tone position **7614** corresponds to a subcarrier separated by 11 subcarriers from the fifth pilot tone position **7612**. The seventh pilot tone position **7614** corresponds to a subcarrier separated by 13 subcarriers from the sixth pilot tone position **7612**. The eighth pilot tone position **7618** corresponds to a subcarrier separated by 11 subcarriers from the seventh pilot tone position **7616** and spaced 6 subcarriers away from a highest-indexed subcarrier of the 52-subcarrier RU **7610**.

[0646] FIG. **76** illustrates a nested design in which the 52-subcarrier RU **7610** uses the same pilot tone positions as the first and second RUs **7600A** and **7600B**, but embodiments are not limited thereto.

[0647] FIG. **77** illustrates another option for pilot tone positions in Case 2, according to embodiments. FIG. **77** can be interpreted as illustrating two embodiments, according to whether a reference subcarrier index f_0 is even or odd.

[0648] FIG. **77** illustrates a first embodiment including a 52-subcarrier RU **7710** being an even RU and having pilot tone positions such as may be used with an even mapping of a HE-LTF sequence in a $2 \times$ LTF design, wherein a reference subcarrier index f_0 has a value equal to $2 \times N$, where N is an integer. FIG. **77** also illustrates pilot tone positions of a first 26-subcarrier RU **7700A** and a second 26-subcarrier RU **7700B** that occupy a plurality of subcarriers occupied by the 52-subcarrier RU **7710** and that would be even RUs in the first embodiment.

[0649] FIG. **77** illustrates a second embodiment including a 52-subcarrier RU **7710** being an odd RU and having pilot tone positions such as may be used with an odd mapping of a HE-LTF sequence in a $2 \times$ LTF design, wherein the reference subcarrier index f_0 has a value equal to $2 \times N + 1$, where N is an integer. FIG. **77** also illustrates pilot tone positions of a first 26-subcarrier RU **7700A** and a second 26-subcarrier RU **7700B** that occupy a plurality of subcarriers occupied by the 52-subcarrier RU **7710** and that would be odd RUs in the second embodiment.

[0650] In FIG. **77**, a lowest-indexed subcarrier of the 52-subcarrier RU **7710** is aligned with a lowest-indexed subcarrier of the first 26-subcarrier RU **7700A** and a highest-indexed subcarrier of the 52-subcarrier RU **7710** is aligned with a highest-indexed subcarrier of the second 26-subcarrier RU **7700B**.

[0651] The first 26-subcarrier RU **7700A** includes first and second pilot tone positions **7702** and **7704**. The first pilot

tone position **7702** corresponds to a subcarrier spaced 6 subcarriers away from a lowest-indexed subcarrier of the first 26-subcarrier RU **7700A**. The second pilot tone position **7704** corresponds to a subcarrier separated by 13 subcarriers from the first pilot tone position **7702** and spaced 5 subcarriers away from a highest-indexed subcarrier of the first 26-subcarrier RU **7700A**.

[**0652**] The second 26-subcarrier RU **7700B** includes third and fourth pilot tone positions **7706** and **7708**. The third pilot tone position **7706** corresponds to a subcarrier spaced 6 subcarriers away from a lowest-indexed subcarrier of the second 26-subcarrier RU **7700B**. The fourth pilot tone position **7708** corresponds to a subcarrier separated by 13 subcarriers from the first pilot tone position **7706** and spaced 5 subcarriers away from the highest-indexed subcarrier of the second 26-subcarrier RU **7700B**.

[**0653**] The 52-subcarrier RU **7710** includes fifth, sixth, seventh, and eighth pilot tone positions **7712**, **7714**, **7716**, and **7718**. The fifth, sixth, seventh, and eighth pilot tone positions **7712**, **7714**, **7716**, and **7718** of the 52-subcarrier RU **7710** respectively correspond to the first, second, third, and fourth pilot tone positions **7702**, **7704**, **7706**, and **7708** of the first and second 26-subcarrier RUs **7700A** and **7700B**.

[**0654**] The fifth pilot tone position **7712** corresponds to a subcarrier spaced 6 subcarriers away from the lowest-indexed subcarrier of the 52-subcarrier RU **7710**. The sixth pilot tone position **7714** corresponds to a subcarrier separated by 13 subcarriers from the fifth pilot tone position **7712**. The seventh pilot tone position **7716** corresponds to a subcarrier separated by 11 subcarriers from the sixth pilot tone position **7712**. The eighth pilot tone position **7718** corresponds to a subcarrier separated by 13 subcarriers from the seventh pilot tone position **7716** and spaced 5 subcarriers away from a highest-indexed subcarrier of the 52-subcarrier RU **7710**.

[**0655**] FIG. **77** illustrates a nested design in which the 52-subcarrier RU **7710** uses the same pilot tone positions as the first and second RUs **7700A** and **7700B**, but embodiments are not limited thereto.

[**0656**] FIG. **78** illustrates another option for pilot tone positions in Case 2, according to embodiments. FIG. **78** can be interpreted as illustrating two embodiments, according to whether a reference subcarrier index f_0 is even or odd.

[**0657**] FIG. **78** illustrates a first embodiment including a 52-subcarrier RU **7810** being an even RU and having pilot tone positions such as may be used with an odd mapping of a HE-LTF sequence in a $2 \times$ LTF design, wherein a reference subcarrier index f_0 has a value equal to $2 \times N$, where N is an integer. FIG. **78** also illustrates pilot tone positions of a first 26-subcarrier RU **7800A** and a second 26-subcarrier RU **7800B** that occupy a plurality of subcarriers occupied by the 52-subcarrier RU **7810** and that would be even RUs in the first embodiment.

[**0658**] FIG. **78** illustrates a second embodiment including a 52-subcarrier RU **7810** being an odd RU and having pilot tone positions such as may be used with an even mapping of a HE-LTF sequence in a $2 \times$ LTF design, wherein the reference subcarrier index f_0 has a value equal to $2 \times N + 1$, where N is an integer. FIG. **78** also illustrates pilot tone positions of a first 26-subcarrier RU **7800A** and a second 26-subcarrier RU **7800B** that occupy a plurality of subcarriers occupied by the 52-subcarrier RU **7810** and that would be odd RUs in the second embodiment.

[**0659**] In FIG. **78**, a lowest-indexed subcarrier of the 52-subcarrier RU **7810** is aligned with a lowest-indexed subcarrier of the first 26-subcarrier RU **7800A** and a highest-indexed subcarrier of the 52-subcarrier RU **7810** is aligned with a highest-indexed subcarrier of the second 26-subcarrier RU **7800B**.

[**0660**] The first 26-subcarrier RU **7800A** includes first and second pilot tone positions **7802** and **7804**. The first pilot tone position **7802** corresponds to a subcarrier spaced 5 subcarriers away from a lowest-indexed subcarrier of the first 26-subcarrier RU **7800A**. The second pilot tone position **7804** corresponds to a subcarrier separated by 13 subcarriers from the first pilot tone position **7802** and spaced 6 subcarriers away from a highest-indexed subcarrier of the first 26-subcarrier RU **7800A**.

[**0661**] The second 26-subcarrier RU **7800B** includes third and fourth pilot tone positions **7806** and **7808**. The third pilot tone position **7806** corresponds to a subcarrier spaced 5 subcarriers away from a lowest-indexed subcarrier of the second 26-subcarrier RU **7800B**. The fourth pilot tone position **7808** corresponds to a subcarrier separated by 13 subcarriers from the first pilot tone position **7806** and spaced 6 subcarriers away from the highest-indexed subcarrier of the second 26-subcarrier RU **7800B**.

[**0662**] The 52-subcarrier RU **7810** includes fifth, sixth, seventh, and eighth pilot tone positions **7812**, **7814**, **7816**, and **7818**. The fifth, sixth, seventh, and eighth pilot tone positions **7812**, **7814**, **7816**, and **7818** of the 52-subcarrier RU **7810** respectively correspond to the first, second, third, and fourth pilot tone positions **7802**, **7804**, **7806**, and **7808** of the first and second 26-subcarrier RUs **7800A** and **7800B**.

[**0663**] The fifth pilot tone position **7812** corresponds to a subcarrier spaced 5 subcarriers away from the lowest-indexed subcarrier of the 52-subcarrier RU **7810**. The sixth pilot tone position **7814** corresponds to a subcarrier separated by 13 subcarriers from the fifth pilot tone position **7812**. The seventh pilot tone position **7816** corresponds to a subcarrier separated by 11 subcarriers from the sixth pilot tone position **7812**. The eighth pilot tone position **7818** corresponds to a subcarrier separated by 13 subcarriers from the seventh pilot tone position **7816** and spaced 6 subcarriers away from a highest-indexed subcarrier of the 52-subcarrier RU **7810**.

[**0664**] FIG. **78** illustrates a nested design in which the 52-subcarrier RU **7810** uses the same pilot tone positions as the first and second RUs **7800A** and **7800B**, but embodiments are not limited thereto.

[**0665**] Embodiments include processes for transmitting and receiving frames including pilot signals within allocated resources of an OFDMA transmission wherein locations of the pilots are chosen that maximize frequency diversity gain and improve carrier frequency offset tracking performance.

[**0666**] FIG. **79** illustrates a process **7900** for transmitting a frame in a wireless network, according to an embodiment. The process **7900** may be performed by a wireless device configured to transmit frames.

[**0667**] At **S7902**, Resource Units (RU) of the frame are determined. In an embodiment, the RUs are RUs of a payload portion of an Orthogonal Frequency Division Multiple Access (OFDMA) frame.

[**0668**] At **S7904**, pilots are included into one or more odd 26-subcarrier RUs of the frame at a first set of positions

relative to respective lowest subcarriers of the odd 26-subcarrier RUs. An odd RU is an RU wherein the lowest subcarrier has an odd index.

[0669] At S7906, pilots are included into one or more even 26-subcarrier RUs of the frame at a second set of positions relative to respective lowest subcarriers of the even 26-subcarrier RUs. An even RU is an RU wherein the lowest subcarrier has an even index.

[0670] In an embodiment, the first set of positions is different than the second set of positions. In an embodiment, the first set of positions is a mirror image of the second set of positions.

[0671] At S7908, pilots are included into a center 26-subcarrier RU of the frame at a third set of positions relative to respective lowest subcarriers of the center 26-subcarrier RUs. A center RU is an RU including at least one center-most non-DC subcarrier of the subchannel including the RU.

[0672] In an embodiment, the first set of positions is different than the third set of positions and the second set of positions is different than the third set of positions.

[0673] At S7910, the wireless device transmits the frame.

[0674] FIG. 80 illustrates another process 8000 for transmitting a frame in a wireless network, according to an embodiment. The process 8000 may be performed by a wireless device configured to transmit frames.

[0675] At S8002, Resource Units (RU) of the frame are determined. In an embodiment, the RUs are RUs of a payload portion of an Orthogonal Frequency Division Multiple Access (OFDMA) frame.

[0676] At S8004, pilots are included into one or more 52-subcarrier RUs of a first plurality of RUs of the frame at a first set of positions relative to respective lowest subcarriers of the 52-subcarrier RUs. In an embodiment, the first plurality of RUs are even RUs.

[0677] At S8006, pilots are included into one or more 52-subcarrier RUs of a second plurality of RUs of the frame at a second set of positions relative to respective lowest subcarriers of the 52-subcarrier RUs. In an embodiment, the first plurality of RUs are odd RUs.

[0678] In an embodiment, the first set of positions is different than the second set of positions. In an embodiment, the first set of positions is a mirror image of the second set of positions.

[0679] At S8010, the wireless device transmits the frame.

[0680] FIG. 81 illustrates a process 8100 for transmitting a frame in a wireless network, according to an embodiment. The process 8100 may be performed by a wireless device configured to transmit frames.

[0681] At S8102, the process 8100 inserts a first plurality of pilots into a Resource Unit (RU) for a High Efficiency Long Training Field (HE-LTF) symbol. The process 8100 determines respective positions of the first plurality of pilots based on i) a size of the RU, ii) whether a lowest subcarrier of the RU has an odd-numbered index or an even numbered index, and iii) whether the RU is a center RU.

[0682] At S8104, the process 8100 inserts a second plurality of pilots into a Resource Unit (RU) for a data symbol. The process 8100 determines respective positions of the second plurality of pilots based on i) a size of the RU, ii) whether a lowest subcarrier of the RU has an odd-numbered index or an even numbered index, and iii) whether the RU is a center RU.

[0683] At S8106, the process 8100 transmits a frame. The frame includes the HE-LTF symbol and the data symbol.

[0684] FIG. 82 illustrates a sub-process 8200 for inserting pilots, according to an embodiment. The sub-process 8200 may be included in S8102, S8104, or both of process 8100 of FIG. 81.

[0685] At S8202, the sub-process 8200 determines whether an RU includes 26 or 52 subcarriers. When the RU includes 52 subcarriers, at S8202 the sub-process 8200 proceeds to S8204. Otherwise, when the RU includes 26 subcarriers, at S8202 the sub-process 8200 proceeds to S8210.

[0686] At S8204, the sub-process 8200 determines whether a lowest subcarrier of the RU has an odd index (i.e. the RU is an odd RU) or an even index (i.e. the RU is an even RU). When the RU is the odd RU, at S8204 the sub-process 8200 proceeds to S8206. Otherwise, when the RU is the even RU, at S8204 the sub-process 8200 proceeds to S8208.

[0687] At S8206, sub-process 8200 inserts a plurality of pilots into a symbol at a first set of predetermined positions, respectively.

[0688] At S8208, sub-process 8200 inserts a plurality of pilots into a symbol at a second set of predetermined positions, respectively.

[0689] At S8210, the sub-process 8200 determines whether the RU has a center RU. When the RU is the center RU, at S8210 the sub-process 8200 proceeds to S8214. Otherwise, at S8210 the sub-process 8200 proceeds to S8212.

[0690] At S8212, the sub-process 8200 determines whether a lowest subcarrier of the RU has an odd index (i.e. the RU is an odd RU) or an even index (i.e. the RU is an even RU). When the RU is the odd RU, at S8212 the sub-process 8200 proceeds to S8216. Otherwise, when the RU is the even RU, at S8212 the sub-process 8200 proceeds to S8218.

[0691] At S8214, sub-process 8200 inserts a plurality of pilots into a symbol at a third set of predetermined positions, respectively.

[0692] At S8216, sub-process 8200 inserts a plurality of pilots into a symbol at a fourth set of predetermined positions, respectively.

[0693] At S8218, sub-process 8200 inserts a plurality of pilots into a symbol at a fifth set of predetermined positions, respectively.

[0694] In an embodiment, each of the first, second, third, fourth, and fifth sets of predetermined positions is different from every other of the first, second, third, fourth, and fifth sets of predetermined positions.

[0695] FIG. 83 illustrates a process 8300 for receiving a frame in a wireless network, according to an embodiment. The process 8300 may be performed by a wireless device configured to receive frames.

[0696] At S8302, the process 8300 receives a frame. The frame includes High Efficiency Long Training Field (HE-LTF) symbols and data symbols.

[0697] At S8304, the process 8300 obtains a first plurality of pilots from a Resource Unit (RU) for a HE-LTF symbol of the frame. The process 8300 determines respective positions of the first plurality of pilots based on i) a size of the RU, ii) whether a lowest subcarrier of the RU has an odd-numbered index or an even numbered index, and iii) whether the RU is a center RU.

[0698] At S8306, the process 8300 obtains a second plurality of pilots from a Resource Unit (RU) for a data symbol of the frame. The process 8300 determines respective positions of the second plurality of pilots based on i) a size of the

RU, ii) whether a lowest subcarrier of the RU has an odd-numbered index or an even numbered index, and iii) whether the RU is a center RU.

[0699] At S8308, the process 8400 processes the HE-LTF symbol.

[0700] At S8310, the process 8400 processes the data symbol.

[0701] FIG. 84 illustrates a sub-process 8400 for obtaining pilots, according to an embodiment. The sub-process 8400 may be included in S8304, S8306, or both of process 8300 of FIG. 83.

[0702] At S8402, the sub-process 8400 determines whether an RU includes 26 or 52 subcarriers. When the RU includes 52 subcarriers, at S8402 the sub-process 8400 proceeds to S8404. Otherwise, when the RU includes 26 subcarriers, at S8402 the sub-process 8400 proceeds to S8410.

[0703] At S8404, the sub-process 8400 determines whether a lowest subcarrier of the RU has an odd index (i.e. the RU is an odd RU) or an even index (i.e. the RU is an even RU). When the RU is the odd RU, at S8404 the sub-process 8400 proceeds to S8406. Otherwise, when the RU is the even RU, at S8404 the sub-process 8400 proceeds to S8408.

[0704] At S8406, sub-process 8400 obtains a plurality of pilots from a first set of predetermined positions within a symbol of the RU, respectively.

[0705] At S8408, sub-process 8400 obtains a plurality of pilots from a second set of predetermined positions within the symbol, respectively.

[0706] At S8410, the sub-process 8400 determines whether the RU has a center RU. When the RU is the center RU, at S8410 the sub-process 8400 proceeds to S8414. Otherwise, at S8410 the sub-process 8400 proceeds to S8412.

[0707] At S8412, the sub-process 8400 determines whether a lowest subcarrier of the RU has an odd index (i.e. the RU is an odd RU) or an even index (i.e. the RU is an even RU). When the RU is the odd RU, at S8412 the sub-process 8400 proceeds to S8416. Otherwise, when the RU is the even RU, at S8412 the sub-process 8400 proceeds to S8418.

[0708] At S8414, sub-process 8400 obtains a plurality of pilots from a third set of predetermined positions within the symbol, respectively.

[0709] At S8416, sub-process 8400 obtains a plurality of pilots from a fourth set of predetermined positions within the symbol, respectively.

[0710] At S8418, sub-process 8400 obtains a plurality of pilots from a fifth set of predetermined positions within the symbol, respectively.

[0711] In an embodiment, each of the first, second, third, fourth, and fifth sets of predetermined positions is different from every other of the first, second, third, fourth, and fifth sets of predetermined positions.

[0712] The above explanation and figures are applied to an HE receiver, an HE frame, an HE PPDU, an HE-SIG field and the like of the IEEE 802.11ax amendment, but they can also be applied to a receiver, a frame, PPDU, a SIG field, and the like of the next amendment of IEEE 802.11.

[0713] Further aspects of the present disclosure relate to one or more of the following clauses.

[0714] In an embodiment, a method of a wireless device for transmitting a frame comprises providing pilots in a resource unit at a plurality of pilot tone positions, and transmitting a frame including the resource unit. The frame

has a plurality of potential pilot tone positions. The plurality of pilot tone positions are a subset of the plurality of potential pilot tone positions. Half of the potential pilot tone positions are mirror-symmetrical with an other half of the potential pilot tone positions about a DC tone of the frame.

[0715] In an embodiment, when the resource unit has 106 subcarriers, the plurality of pilot tone positions include 1) a first pilot tone position having a lowest index among potential pilot tone positions covered by the 106 subcarriers, 2) a second pilot tone position spaced two potential pilot tone positions away from the first pilot tone position, 3) a third pilot tone position spaced three potential pilot tone positions away from the second pilot tone position, and 4) a fourth pilot tone position spaced two potential pilot tone positions away from the third pilot tone position.

[0716] In an embodiment, when the resource unit has 242 subcarriers, the plurality of pilot tone positions include: 1) a first pilot tone position having a lowest index among potential pilot tone positions covered by the 242 subcarriers, 2) a second pilot tone position spaced two potential pilot tone positions away from the first pilot tone position, 3) a third pilot tone position spaced three potential pilot tone positions away from the second pilot tone position, 4) a fourth pilot tone position spaced two potential pilot tone positions away from the third pilot tone position, 5) a fifth pilot tone position spaced three potential pilot tone positions away from the fourth pilot tone position, 6) a sixth pilot tone position spaced two potential pilot tone positions away from the fifth pilot tone position, 7) a seventh pilot tone position spaced three potential pilot tone positions away from the sixth pilot tone position, and 8) an eighth pilot tone position spaced two potential pilot tone positions away from the seventh pilot tone position.

[0717] In an embodiment, when the resource unit has 52 subcarriers, the plurality of pilot tone positions include a first pilot tone position, a second pilot tone position, a third pilot tone position, and a fourth pilot tone position which correspond to potential pilot tone positions covered by the 52 subcarriers.

[0718] In an embodiment, when a lowest-indexed subcarrier of the 52-subcarrier resource unit has an even index, the first pilot tone position is spaced six subcarriers away from the lowest-indexed subcarrier of the resource unit, the second pilot tone position is separated by thirteen subcarriers from the first pilot tone position, the third pilot tone position is separated by eleven subcarriers from the second pilot tone position, and the fourth pilot tone position is separated by thirteen subcarriers from the third pilot tone position and spaced five subcarriers away from the highest-indexed subcarrier of the resource unit. When the lowest-indexed subcarrier of the 52-subcarrier resource unit has an odd index, the first pilot tone position is spaced five subcarriers away from the lowest-indexed subcarrier of the resource unit, the second pilot tone position is separated by thirteen subcarriers from the first pilot tone position, the third pilot tone position is separated by eleven subcarriers from the second pilot tone position, and the fourth pilot tone position is separated by thirteen subcarriers from the third pilot tone position and spaced six subcarriers away from the highest-indexed subcarrier of the resource unit.

[0719] In an embodiment, when the RU has 26 subcarriers, the plurality of pilot tone positions include a first pilot

tone position and a second pilot tone position which correspond to potential pilot tone positions covered by the 26 subcarriers.

[0720] In an embodiment, when a lowest-indexed subcarrier of the 26-subcarrier resource unit has an even index, the first pilot tone position is spaced six subcarriers away from the lowest-indexed subcarrier of the resource unit, and the second pilot tone position is separated by thirteen subcarriers from the first pilot tone position and spaced five subcarriers away from the highest-indexed subcarrier of the resource unit. When a lowest-indexed subcarrier of the 26-subcarrier resource unit has an odd index, the first pilot tone position is spaced five subcarriers away from the lowest-indexed subcarrier of the resource unit, and the second pilot tone position is separated by thirteen subcarriers from the first pilot tone position and spaced six subcarriers away from the highest-indexed subcarrier of the resource unit.

[0721] In an embodiment, when the 26-subcarrier resource unit is a center resource unit that is split into 13 positive-indexed subcarriers and 13 negative-indexed subcarriers by DC tones, the first pilot tone position is spaced six subcarriers away from a lowest-indexed subcarrier of the 26-subcarrier resource unit and spaced six subcarriers away from a highest-indexed subcarrier of the 13 negative-indexed subcarriers, and the second pilot tone position is spaced six subcarriers away from a lowest-indexed subcarrier of 13 positive-indexed subcarriers and spaced six subcarriers away from a highest-indexed subcarrier of the 26-subcarrier resource unit. When the 26-subcarrier resource unit is not the center resource unit and a lowest-indexed subcarrier of the 26-subcarrier resource unit has an even index, the first pilot tone position is spaced six subcarriers away from the lowest-indexed subcarrier of the 26-subcarrier resource unit, and the second pilot tone position is separated by thirteen subcarriers from the first pilot tone position and spaced five subcarriers away from the highest-indexed subcarrier of the 26-subcarrier resource unit. When the 26-subcarrier resource unit is not the center resource unit and a lowest-indexed subcarrier of the 26-subcarrier resource unit has an odd index, the first pilot tone position is spaced five subcarriers away from the lowest-indexed subcarrier of the 26-subcarrier resource unit, and the second pilot tone position is separated by thirteen subcarriers from the first pilot tone position and spaced six subcarriers away from the highest-indexed subcarrier of the 26-subcarrier resource unit.

[0722] In an embodiment, the frame is transmitted on a 20 MHz channel, and a total number of the potential pilot tone positions is 18.

[0723] In an embodiment, the frame is transmitted on a 40 MHz channel, and a total number of the potential pilot tone positions is 36.

[0724] In an embodiment, a method of a wireless device for receiving a frame comprises receiving a frame including a resource unit including pilots which are included at a plurality of pilot tone positions, and processing the pilots. The frame has a plurality of potential pilot tone positions. A half of the potential pilot tone positions is mirror-symmetrical with an other half of the potential pilot tone positions.

[0725] In an embodiment, when the resource unit has 106 subcarriers, the plurality of pilot tone positions include a 1) first pilot tone position having a lowest index among potential pilot tone positions covered by the 106 subcarriers, 2) a

second pilot tone position spaced two potential pilot tone positions away from the first pilot tone position, 3) a third pilot tone position spaced three potential pilot tone positions away from the second pilot tone position, and 4) a fourth pilot tone position spaced two potential pilot tone positions away from the third pilot tone position.

[0726] In an embodiment, when the resource unit has 242 subcarriers, the plurality of pilot tone positions include: 1) a first pilot tone position having a lowest index among potential pilot tone positions covered by the 242 subcarriers, 2) a second pilot tone position spaced two potential pilot tone positions away from the first pilot tone position, 3) a third pilot tone position spaced three potential pilot tone positions away from the second pilot tone position, 4) a fourth pilot tone position spaced two potential pilot tone positions away from the third pilot tone position, 5) a fifth pilot tone position spaced three potential pilot tone positions away from the fourth pilot tone position, 6) a sixth pilot tone position spaced two potential pilot tone positions away from the fifth pilot tone position, 7) a seventh pilot tone position spaced three potential pilot tone positions away from the sixth pilot tone position, and 8) an eighth pilot tone position spaced two potential pilot tone positions away from the seventh pilot tone position.

[0727] In an embodiment, when the resource unit has 52 subcarriers, the plurality of pilot tone positions include a first pilot tone position, a second pilot tone position, a third pilot tone position, and a fourth pilot tone position which correspond to potential pilot tone positions covered by the 52 subcarriers.

[0728] In an embodiment, when a lowest-indexed subcarrier of the 52-subcarrier resource unit has an even index, the first pilot tone position is spaced six subcarriers away from the lowest-indexed subcarrier of the 52-subcarrier resource unit, the second pilot tone position is separated by thirteen subcarriers from the first pilot tone position, the third pilot tone position is separated by eleven subcarriers from the second pilot tone position, and the fourth pilot tone position is separated by thirteen subcarriers from the third pilot tone position and spaced five subcarriers away from the highest-indexed subcarrier of the 52-subcarrier resource unit. When a lowest-indexed subcarrier of the 52-subcarrier resource unit has an odd index, the first pilot tone position is spaced five subcarriers away from the lowest-indexed subcarrier of the 52-subcarrier resource unit, the second pilot tone position is separated by thirteen subcarriers from the first pilot tone position, the third pilot tone position is separated by eleven subcarriers from the second pilot tone position, and the fourth pilot tone position is separated by thirteen subcarriers from the third pilot tone position and spaced six subcarriers away from the highest-indexed subcarrier of the 52-subcarrier resource unit.

[0729] In an embodiment, when the resource unit has 26 subcarriers, the plurality of pilot tone positions include a first pilot tone position and a second pilot tone position which correspond to potential pilot tone positions covered by the 26 subcarriers.

[0730] In an embodiment, when a lowest-indexed subcarrier of the 26-subcarrier resource unit has an even index, the first pilot tone position is spaced six subcarriers away from the lowest-indexed subcarrier of the 26-subcarrier resource unit, and the second pilot tone position is separated by thirteen subcarriers from the first pilot tone position and spaced five subcarriers away from the highest-indexed sub-

carrier of the 26-subcarrier resource unit. When a lowest-indexed subcarrier of the 26-subcarrier resource unit has an odd index, the first pilot tone position is spaced five subcarriers away from the lowest-indexed subcarrier of the 26-subcarrier resource unit, and the second pilot tone position is separated by thirteen subcarriers from the first pilot tone position and spaced six subcarriers away from the highest-indexed subcarrier of the 26-subcarrier resource unit.

[0731] In an embodiment, when the 26-subcarrier resource unit is a center resource unit that is split into 13 positive-indexed subcarriers and 13 negative-indexed subcarriers by DC tones, the first pilot tone position is spaced six subcarriers away from a lowest-indexed subcarrier of the 26-subcarrier resource unit and spaced six subcarriers away from a highest-indexed subcarrier of the 13 negative-indexed subcarriers, and the second pilot tone position is spaced six subcarriers away from a lowest-indexed subcarrier of 13 positive-indexed subcarriers and spaced six subcarriers away from a highest-indexed subcarrier of the 26-subcarrier resource unit. When the 26-subcarrier resource unit is not the center resource unit and a lowest-indexed subcarrier of the 26-subcarrier resource unit has an even index, the first pilot tone position is spaced six subcarriers away from the lowest-indexed subcarrier of the 26-subcarrier resource unit, and the second pilot tone position is separated by thirteen subcarriers from the first pilot tone position and spaced five subcarriers away from the highest-indexed subcarrier of the 26-subcarrier resource unit. When the resource unit is not the center resource unit and a lowest-indexed subcarrier of the 26-subcarrier resource unit has an odd index, the first pilot tone position is spaced five subcarriers away from the lowest-indexed subcarrier of the 26-subcarrier resource unit, and the second pilot tone position is separated by thirteen subcarriers from the first pilot tone position and spaced six subcarriers away from the highest-indexed subcarrier of the 26-subcarrier resource unit.

[0732] In an embodiment, the frame is transmitted on a 20 MHz channel, and a total number of the potential pilot tone positions is 18.

[0733] In an embodiment, the frame is transmitted on a 40 MHz channel, and a total number of the potential pilot tone positions is 36.

[0734] In an embodiment, potential pilot tone positions are aggregation of pilot tone positions used for each 26 subcarrier RU on a given bandwidth.

[0735] Embodiments include frames transmitted on a 20 MHz channel and having a nested pilot structure.

[0736] In an embodiment, a method of a wireless device for transmitting a frame comprises providing pilots in a resource unit (RU), and transmitting a frame including the RU on a 20 MHz channel. The frame has 18 potential pilot tone positions c1 to c18 corresponding to subcarrier indices. For the respective subcarrier indices, c18>c17>c16>c15>c14>c13>c12>c11>c10>c9>c8>c7>c6>c5>c4>c3>c2>c1.

[0737] In an embodiment, for the respective subcarrier indices, c1=-c18, c2=-c17, c3=-c16, c4=-c15, c5=-c14, c6=-c13, c7=-c12, c8=-c11, and c9=-c10.

[0738] In an embodiment, when the RU has a first set of 52 positive-indexed subcarriers, pilots are included at potential pilot tone positions c11, c12, c13 and c14. When the RU has a second set of 52 positive-indexed subcarriers, pilots are included at potential pilot tone positions c15, c16, c17 and c18.

[0739] In an embodiment, when a RU has 106 positive-indexed subcarriers including the first set of 52 positive-indexed subcarriers and the second set of 52 positive-indexed subcarriers, pilots are included at potential pilot tone positions c11, c13, c16 and c18.

[0740] In an embodiment, when the RU has a first set of 26 positive-indexed subcarriers, pilots are included at potential pilot tone positions c11 and c12. When the RU has a second set of 26 positive-indexed subcarriers, pilots are included at potential pilot tone positions c13 and c14. When the RU has a third set of 26 positive-indexed subcarriers, pilots are included at potential pilot tone positions c15 and c16. When the RU has a fourth set of 26 positive-indexed subcarriers, pilots are included at potential pilot tone positions c17 and c18.

[0741] In an embodiment, when the RU has a first set of 52 negative-indexed subcarriers, pilots are included at potential pilot tone positions c1, c2, c3 and c4. When the RU has a second set of 52 negative-indexed subcarriers, pilots are included at potential pilot tone positions c5, c6, c7 and c8.

[0742] In an embodiment, when the RU has 106 negative-indexed subcarriers including the first set of 52 negative-indexed subcarriers and the second set of 52 negative-indexed subcarriers, pilots are included at potential pilot tone positions c1, c3, c6 and c8.

[0743] In an embodiment, when the RU has a first set of 26 negative-indexed subcarriers, pilots are included at potential pilot tone positions c1 and c2. When the RU has a second set of 26 negative-indexed subcarriers, pilots are included at potential pilot tone positions c3 and c4. When the RU has a third set of 26 negative-indexed subcarriers, pilots are included at potential pilot tone positions c5 and c6. When the RU has a fourth set of 26 negative-indexed subcarriers, pilots are included at potential pilot tone positions c7 and c8.

[0744] In an embodiment, when the RU has 26 subcarriers that are split into 13 positive-indexed subcarriers and 13 negative-indexed subcarriers by DC tones, pilots are included at potential pilot tone positions c9 and c10.

[0745] In an embodiment, when the RU has a set of 242 subcarriers that are split into 121 positive-indexed subcarriers and 121 negative-indexed subcarriers by DC tones, pilots are included at potential pilot tone positions c1, c3, c6, c8, c11, c13, c16 and c18.

[0746] In an embodiment, a method of a wireless device for receiving a frame comprises receiving, on a 20 MHz channel, a frame including a resource unit including pilots, and processing the pilots in the resource unit. The frame has 18 potential pilot tone positions c1 to c18 corresponding to subcarrier indices. For the respective subcarrier indices, c18>c17>c16>c15>c14>c13>c12>c11>c10>c9>c8>c7>c6>c5>c4>c3>c2>c1.

[0747] In an embodiment, for the respective subcarrier indices, c1=-c18, c2=-c17, c3=-c16, c4=-c15, c5=-c14, c6=-c13, c7=-c12, c8=-c11, and c9=-c10.

[0748] In an embodiment, when the RU has a first set of 52 positive-indexed subcarriers, pilots are included at potential pilot tone positions c11, c12, c13 and c14. When the RU has a second set of 52 positive-indexed subcarriers, pilots are included at potential pilot tone positions c15, c16, c17 and c18.

[0749] In an embodiment, when a RU has 106 positive-indexed subcarriers, pilots are included at potential pilot tone positions c11, c13, c16 and c18.

[0750] In an embodiment, when the RU has a first set of 26 positive-indexed subcarriers, pilots are included at potential pilot tone positions c11 and c12. When the RU has a second set of 26 positive-indexed subcarriers, pilots are included at potential pilot tone positions c13 and c14. When the RU has a third set of 26 positive-indexed subcarriers, pilots are included at potential pilot tone positions c15 and c16. When the RU has a fourth set of 26 positive-indexed subcarriers, pilots are included at potential pilot tone positions c17 and c18.

[0751] In an embodiment, when the RU has a first set of 52 negative-indexed subcarriers, pilots are included at potential pilot tone positions c1, c2, c3 and c4. When the RU has a second set of 52 negative-indexed subcarriers, pilots are included at potential pilot tone positions c5, c6, c7 and c8.

[0752] In an embodiment, when the RU has 106 negative-indexed subcarriers, pilots are included at potential pilot tone positions c1, c3, c6 and c8.

[0753] In an embodiment, when the RU has a first set of 26 negative-indexed subcarriers, pilots are included at potential pilot tone positions c1 and c2. When the RU has a second set of 26 negative-indexed subcarriers, pilots are included at potential pilot tone positions c3 and c4. When the RU has a third set of 26 negative-indexed subcarriers, pilots are included at potential pilot tone positions c5 and c6. When the RU has a fourth set of 26 negative-indexed subcarriers, pilots are included at potential pilot tone positions c7 and c8.

[0754] In an embodiment, when the RU has 26 subcarriers that are split into 13 positive-indexed subcarriers and 13 negative-indexed subcarriers by DC tones, pilots are included at potential pilot tone positions c9 and c10.

[0755] In an embodiment, when the RU has a set of 242 subcarriers that are split into 121 positive-indexed subcarriers and 121 negative-indexed subcarriers by DC tones, pilots are included at potential pilot tone positions c1, c3, c6, c8, c11, c13, c16 and c18.

[0756] Embodiments include frames transmitted on a 40 MHz channel and having a nested pilot structure.

[0757] In an embodiment, a method of a wireless device for transmitting a frame comprises providing pilots in the resource unit, and transmitting a frame including a resource unit (RU) on a 40 MHz channel. The frame has 36 potential pilot tone positions f1 to f36 corresponding to subcarrier indices. For the respective indices, f36>f35>f34>f33>f32>f31>f30>f29>f28>f27>f26>f25>f24>f23>f22>f21>f20>f19>f18>f17>f16>f15>f14>f13>f12>f11>f10>f9>f8>f7>f6>f5>f4>f3>f2>f1.

[0758] In an embodiment, for the respective indices, f1=f36, f2=f35, f3=f34, f4=f33, f5=f32, f6=f31, f7=f30, f8=f29, f9=f28, f10=f27, f11=f26, f12=f25, f13=f24, f14=f23, f15=f22, f16=f21, f17=f20, and f18=f19.

[0759] In an embodiment, when the RU has a first set of 52 positive-indexed subcarriers, pilots are included at potential pilot tone positions f19, f20, f21 and f22. When the RU has a second set of 52 positive-indexed subcarriers, pilots are included at potential pilot tone positions f23, f24, f25 and f26. When the RU has a third set of 52 positive-indexed subcarriers, pilots are included at potential pilot tone positions f29, f30, f31 and f32. When the RU has a fourth set of 52 positive-indexed subcarriers, pilots are included at potential pilot tone positions f33, f34, f35 and f36.

[0760] In an embodiment, when the RU has a first set of 106 positive-indexed subcarriers, pilots are included at potential pilot tone positions f19, c21, c24 and c26. When

the RU has a second set of 106 positive-indexed subcarriers, pilots are included at potential pilot tone positions c29, c31, c34 and c36.

[0761] In an embodiment, when the RU has a first set of 26 positive-indexed subcarriers, pilots are included at potential pilot tone positions f19 and f20. When the RU has a second set of 26 positive-indexed subcarriers, pilots are included at potential pilot tone positions f21 and f22. When the RU has a third set of 26 positive-indexed subcarriers, pilots are included at potential pilot tone positions f23 and f24. When the RU has a fourth set of 26 positive-indexed subcarriers, pilots are included at potential pilot tone positions f25 and f26. When the RU has a fifth set of 26 positive-indexed subcarriers, pilots are included at potential pilot tone positions f27 and f28. When the RU has a sixth set of 26 positive-indexed subcarriers, pilots are included at potential pilot tone positions f29 and f30. When the RU has a seventh set of 26 positive-indexed subcarriers, pilots are included at potential pilot tone positions f31 and f32. When the RU has an eighth set of 26 positive-indexed subcarriers, pilots are included at potential pilot tone positions f33 and f34. When the RU has a ninth set of 26 positive-indexed subcarriers, pilots are included at potential pilot tone positions f35 and f36.

[0762] In an embodiment, when the RU has a first set of 106 negative-indexed subcarriers, pilots are included at potential pilot tone positions f1, f3, f6 and f8. When the RU has a second set of 106 negative-indexed subcarriers, pilots are included at potential pilot tone positions f11, f13, f16 and f18.

[0763] In an embodiment, when the RU has a first set of 52 negative-indexed subcarriers, pilots are included at potential pilot tone positions f1, f2, f3 and f4. When the RU has a second set of 52 negative-indexed subcarriers, pilots are included at potential pilot tone positions f5, f6, f7 and f8. When the RU has a third set of 52 negative-indexed subcarriers, pilots are included at potential pilot tone positions f11, f12, f13 and f14. When the RU has a fourth set of 52 negative-indexed subcarriers, pilots are included at potential pilot tone positions f15, f16, f17 and f18.

[0764] In an embodiment, when the RU has a first set of 26 negative-indexed subcarriers, pilots are included at potential pilot tone positions f1 and f2. When the RU has a second set of 26 negative-indexed subcarriers, pilots are included at potential pilot tone positions f3 and f4. When the RU has a third set of 26 negative-indexed subcarriers, pilots are included at potential pilot tone positions f5 and f6. When the RU has a fourth set of 26 negative-indexed subcarriers, pilots are included at potential pilot tone positions f7 and f8. When the RU has a fifth set of 26 negative-indexed subcarriers, pilots are included at potential pilot tone positions f9 and f10. When the RU has a sixth set of 26 negative-indexed subcarriers, pilots are included at potential pilot tone positions f11 and f12. When the RU has a seventh set of 26 negative-indexed subcarriers, pilots are included at potential pilot tone positions f13 and f14. When the RU has an eighth set of 26 negative-indexed subcarriers, pilots are included at potential pilot tone positions f15 and f16. When the RU has a ninth set of 26 negative-indexed subcarriers, pilots are included at potential pilot tone positions f17 and f18.

[0765] In an embodiment, when the RU has 242 positive-indexed subcarriers, pilots are included at potential pilot tone positions f19, f21, f24, f26, f29, f31, f34 and f36. When

the RU has 242 negative-indexed subcarriers, pilots are included at potential pilot tone positions f1, f3, f6, f8, f11, f13, f16, and f18.

[0766] In an embodiment, when the RU has 484 subcarriers that are split into 242 positive-indexed subcarriers and 242 negative-indexed subcarriers by DC tones, pilots are included at potential pilot tone positions f1, f3, f6, f8, f11, f13, f16, f18, f19, f21, f24, f26, f29, f31, f34 and f36.

[0767] In an embodiment, a method of a wireless device for receiving a frame comprises receiving, on 40 MHz channel, a frame including a resource unit including pilots, and processing pilots in the resource unit. The frame has 36 potential pilot tone positions f1 to f36 corresponding to subcarrier indices. For the respective subcarrier indices, f36>f35>f34>f33>f32>f31>f30>f29>f28>f27>f26>f25>f24>f23>f22>f21>f20>f19>f18>f17>f16>f15>f14>f13>f12>f11>f10>f9>f8>f7>f6>f5>f4>f3>f2>f1.

[0768] In an embodiment, for the respective subcarrier indices, f1=-f36, f2=-f35, f3=-f34, f4=-f33, f5=-f32, f6=-f31, f7=-f30, f8=-f29, f9=-f28, f10=-f27, f11=-f26, f12=-f25, f13=-f24, f14=-f23, f15=-f22, f16=-f21, f17=-f20, and f18=-f19.

[0769] In an embodiment, when the RU has a first set of 52 positive-indexed subcarriers, pilots are included at potential pilot tone positions f19, f20, f21 and f22. When the RU has a second set of 52 positive-indexed subcarriers, pilots are included at potential pilot tone positions f23, f24, f25 and f26. When the RU has a third set of 52 positive-indexed subcarriers, pilots are included at potential pilot tone positions f29, f30, f31 and f32. When the RU has a fourth set of 52 positive-indexed subcarriers, pilots are included at potential pilot tone positions f33, f34, f35 and f36.

[0770] In an embodiment, when the RU has a first set of 106 positive-indexed subcarriers, pilots are included at potential pilot tone positions f19, c21, c24 and c26. When the RU has a second set of 106 positive-indexed subcarriers, pilots are included at potential pilot tone positions c29, c31, c34 and c36.

[0771] In an embodiment, when the RU has a first set of 26 positive-indexed subcarriers, pilots are included at potential pilot tone positions f19 and f20. When the RU has a second set of 26 positive-indexed subcarriers, pilots are included at potential pilot tone positions f21 and f22. When the RU has a third set of 26 positive-indexed subcarriers, pilots are included at potential pilot tone positions f23 and f24. When the RU has a fourth set of 26 positive-indexed subcarriers, pilots are included at potential pilot tone positions f25 and f26. When the RU has a fifth set of 26 positive-indexed subcarriers, pilots are included at potential pilot tone positions f27 and f28. When the RU has a sixth set of 26 positive-indexed subcarriers, pilots are included at potential pilot tone positions f29 and f30. When the RU has a seventh set of 26 positive-indexed subcarriers, pilots are included at potential pilot tone positions f31 and f32. When the RU has an eighth set of 26 positive-indexed subcarriers, pilots are included at potential pilot tone positions f33 and f34. When the RU has a ninth set of 26 positive-indexed subcarriers, pilots are included at potential pilot tone positions f35 and f36.

[0772] In an embodiment, when the RU has a first set of 106 negative-indexed subcarriers, pilots are included at potential pilot tone positions f1, f3, f6 and f8. When the RU has a second set of 106 negative-indexed subcarriers, pilots are included at potential pilot tone positions f11, f13, f16 and f18.

[0773] In an embodiment, when the RU has a first set of 52 negative-indexed subcarriers, pilots are included at potential pilot tone positions f1, f2, f3 and f4. When the RU has a second set of 52 negative-indexed subcarriers, pilots are included at potential pilot tone positions f5, f6, f7 and f8. When the RU has a third set of 52 negative-indexed subcarriers, pilots are included at potential pilot tone positions f11, f12, f13 and f14. When the RU has a fourth set of 52 negative-indexed subcarriers, pilots are included at potential pilot tone positions f15, f16, f17 and f18.

[0774] In an embodiment, when the RU has a first set of 26 negative-indexed subcarriers, pilots are included at potential pilot tone positions f1 and f2. When the RU has a second set of 26 negative-indexed subcarriers, pilots are included at potential pilot tone positions f3 and f4. When the RU has a third set of 26 negative-indexed subcarriers, pilots are included at potential pilot tone positions f5 and f6. When the RU has a fourth set of 26 negative-indexed subcarriers, pilots are included at potential pilot tone positions f7 and f8. When the RU has a fifth set of 26 negative-indexed subcarriers, pilots are included at potential pilot tone positions f9 and f10. When the RU has a sixth set of 26 negative-indexed subcarriers, pilots are included at potential pilot tone positions f11 and f12. When the RU has a seventh set of 26 negative-indexed subcarriers, pilots are included at potential pilot tone positions f13 and f14. When the RU has an eighth set of 26 negative-indexed subcarriers, pilots are included at potential pilot tone positions f15 and f16. When the RU has a ninth set of 26 negative-indexed subcarriers, pilots are included at potential pilot tone positions f17 and f18.

[0775] In an embodiment, when a RU has 242 positive-indexed subcarriers, pilots are included at potential pilot tone positions f19, f21, f24, f26, f29, f31, f34 and f36. When the RU has 242 negative-indexed subcarriers, pilots are included at potential pilot tone positions f1, f3, f6, f8, f11, f13, f16, and f18.

[0776] In an embodiment, when the RU has 484 subcarriers that are split into 242 positive-indexed subcarriers and 242 negative-indexed subcarriers by DC tones, pilots are included at potential pilot tone positions f1, f3, f6, f8, f11, f13, f16, f18, f19, f21, f24, f26, f29, f31, f34 and f36.

[0777] Embodiments further include frames having a nested pilot structure between 26-subchannel resource units and 52-subchannel resource units.

[0778] In an embodiment, a method of a wireless device for transmitting a frame comprises providing pilots in a resource unit, and transmitting a frame including the resource unit. When the resource unit has 52 subcarriers whose lowest index number is f0, pilots are included at a first pilot tone position, a second pilot tone position, a third pilot tone position, and a fourth pilot tone position, respectively. When the resource unit has 26 subcarriers whose lowest index number is equal to f0, pilots are included at a fifth pilot tone position, and a sixth pilot tone position, respectively. The fifth pilot tone position is the same as the first pilot tone position, and the sixth pilot tone position is the same as the second pilot tone position.

[0779] In an embodiment, when the resource unit has 26 subcarriers whose lowest index number is equal to (f0+26), pilots are included at a seventh pilot tone position, and an eighth pilot tone position, respectively. The seventh pilot tone position is the same as the third pilot tone position, and the eighth pilot tone position is the same as the fourth pilot tone position.

[0794] Embodiments of the present disclosure include electronic devices configured to perform one or more of the operations described herein. However, embodiments are not limited thereto.

[0795] Embodiments of the present disclosure may further include systems configured to operate using the processes described herein. The systems may include basic service sets (BSSs) such as the BSSs **100** of FIG. **1**, but embodiments are not limited thereto.

[0796] Embodiments of the present disclosure may be implemented in the form of program instructions executable through various computer means, such as a processor or microcontroller, and recorded in a non-transitory computer-readable medium. The non-transitory computer-readable medium may include one or more of program instructions, data files, data structures, and the like. The program instructions may be adapted to execute the processes and to generate and decode the frames described herein when executed on a device such as the wireless devices shown in FIG. **1**.

[0797] In an embodiment, the non-transitory computer-readable medium may include a read only memory (ROM), a random access memory (RAM), or a flash memory. In an embodiment, the non-transitory computer-readable medium may include a magnetic, optical, or magneto-optical disc such as a hard disk drive, a floppy disc, a CD-ROM, and the like.

[0798] While this invention has been described in connection with what is presently considered to be practical embodiments, embodiments are not limited to the disclosed embodiments, but, on the contrary, may include various modifications and equivalent arrangements included within the spirit and scope of the appended claims. The order of operations described in a process is illustrative and some operations may be re-ordered. Further, two or more embodiments may be combined.

What is claimed is:

1. A wireless device for transmitting a frame, the wireless device comprising:

a processor; and

a memory device coupled to the processor and storing instructions that when executed by the processor cause the wireless device to perform steps comprising:

determining, by the wireless device, a plurality of Resource Units (RUs) of the frame;

providing, by the wireless device, a first plurality of pilots in one or more RUs of the plurality of RUs at a first set of positions, respectively; and

transmitting, by the wireless device, the frame,

wherein the frame is an Orthogonal Frequency Division Multiple Access (OFDMA) frame and the plurality of RUs include respective pluralities of subcarriers,

wherein the first set of positions are uniformly spaced,

wherein a first RU is a 26-subcarrier RU and a second RU of the frame is a 52-subcarrier RU,

wherein the first set of positions correspond to non-null positions of a Long Training field (LTF) of the frame, and

wherein when the frame includes a 4× High Efficiency (HE) Long Training Field (HE-LTF), the first RU carries two pilots, and the second RU carries four pilots.

2. The wireless device of claim **1**, wherein when the frame includes a 2×HE-LTF, the first RU carries one pilot, and the second RU carries two pilots.

3. The wireless device of claim **2** wherein no pilots are carried in a central 26 subcarrier RU of the frame.

4. The wireless device of claim **1**, wherein a tone spacing of the pilots includes 12 subcarriers between two of the pilots of the first RU, 6 subcarriers between outer edges of the first RU and respective nearest pilot tone positions of the outer edges of the first RU, 12 subcarriers between two of the pilots of the second RU, and 6 subcarriers between outer edges of the second RU and respective nearest pilot tone positions of the outer edges of the second RU.

5. The wireless device of claim **4** wherein the tone spacing does not include any of DC subcarriers of the frame.

6. A wireless device for receiving a frame, the wireless device comprising:

a processor; and

a memory device coupled to the processor and storing instructions that when executed by the processor cause the wireless device to perform steps comprising:

receiving, by the wireless device, a plurality of Resource Units (RUs) of the frame;

extracting, by the wireless device, a first plurality of pilots from one or more RUs of the plurality RU at a first set of positions, respectively; and

processing, by the wireless device, the frame using the first plurality of pilots,

wherein the frame is an Orthogonal Frequency Division Multiple Access (OFDMA) frame and the plurality of RUs include respective pluralities of subcarriers,

wherein the first set of positions are uniformly spaced,

wherein a first RU is a 26-subcarrier RU and a second RU of the frame is a 52-subcarrier RU,

wherein the first set of positions correspond to non-null positions of a Long Training field (LTF) of the frame, and

wherein when the frame includes a 4× High Efficiency (HE) Long Training Field (HE-LTF), the first RU carries two pilots, and the second RU carries four pilots.

7. The wireless device of claim **6**, wherein when the frame includes a 2×HE-LTF, the first RU carries one pilot, and the second RU carries two pilots.

8. The wireless device of claim **7** wherein no pilots are carried in a central 26 subcarrier RU of the frame.

9. The wireless device of claim **6**, wherein a tone spacing of the pilots includes 12 subcarriers between two of the pilots of the first RU, 6 subcarriers between outer edges of the first RU and respective nearest pilot tone positions of the outer edges of the first RU, 12 subcarriers between two of the pilots of the second RU, and 6 subcarriers between outer edges of the second RU and respective nearest pilot tone positions of the outer edges of the second RU.

10. The wireless device of claim **9** wherein the tone spacing does not include any of DC subcarriers of the frame.

11. A method for transmitting a frame by a wireless device, the method comprising:

determining, by the wireless device, a plurality of Resource Units (RUs) of the frame;

providing, by the wireless device, a first plurality of pilots in one or more RUs of the plurality of RUs at a first set of positions, respectively; and

transmitting, using a transmitter of the wireless device, the frame,
 wherein the frame is an Orthogonal Frequency Division Multiple Access (OFDMA) frame and the plurality of RUs include respective pluralities of subcarriers, wherein the first set of positions are uniformly spaced, wherein a first RU is a 26-subcarrier RU and a second RU of the frame is a 52-subcarrier RU,
 wherein the first set of positions correspond to non-null positions of a Long Training field (LTF) of the frame, and
 wherein when the frame includes a 4× High Efficiency (HE) Long Training Field (HE-LTF), the first RU carries two pilots, and the second RU carries four pilots.

12. The method of claim **11**, wherein when the frame includes a 2×HE-LTF, the first RU carries one pilot, and the second RU carries two pilots.

13. The method of claim **12** wherein no pilots are carried in a central 26 subcarrier RU of the frame.

14. The method of claim **11**, wherein a tone spacing of the pilots includes 12 subcarriers between two of the pilots of the first RU, 6 subcarriers between outer edges of the first RU and respective nearest pilot tone positions of the outer edges of the first RU, 12 subcarriers between two of the pilots of the second RU, and 6 subcarriers between outer edges of the second RU and respective nearest pilot tone positions of the outer edges of the second RU.

15. The method of claim **14** wherein the tone spacing does not include any of DC subcarriers of the frame.

16. A method for receiving a frame by a wireless device, the method comprising:

receiving, using a receiver of the wireless device, a plurality of Resource Units (RUs) of the frame;

extracting, by the wireless device, a first plurality of pilots from one or more RUs of the plurality RU at a first set of positions, respectively; and
 processing, by the wireless device, the frame using the first plurality of pilots,
 wherein the frame is an Orthogonal Frequency Division Multiple Access (OFDMA) frame and the plurality of RUs include respective pluralities of subcarriers, wherein the first set of positions are uniformly spaced, wherein a first RU is a 26-subcarrier RU and a second RU of the frame is a 52-subcarrier RU,
 wherein the first set of positions correspond to non-null positions of a Long Training field (LTF) of the frame, and
 wherein when the frame includes a 4× High Efficiency (HE) Long Training Field (HE-LTF), the first RU carries two pilots, and the second RU carries four pilots.

17. The method of claim **16**, wherein when the frame includes a 2×HE-LTF, the first RU carries one pilot, and the second RU carries two pilots.

18. The method of claim **17** wherein no pilots are carried in a central 26 subcarrier RU of the frame.

19. The method of claim **16**, wherein tone spacing of the pilots includes 12 subcarriers between two of the pilots of the first RU, 6 subcarriers between outer edges of the first RU and respective nearest pilot tone positions of the outer edges of the first RU, 12 subcarriers between two of the pilots of the second RU, and 6 subcarriers between outer edges of the second RU and respective nearest pilot tone positions of the outer edges of the second RU.

20. The method of claim **19** wherein the tone spacing does not include any of DC subcarriers of the frame.

* * * * *