



US009800818B2

(12) **United States Patent**
Arling et al.

(10) **Patent No.:** **US 9,800,818 B2**
(45) **Date of Patent:** **Oct. 24, 2017**

(54) **SYSTEM AND METHOD FOR OPTIMIZED APPLIANCE CONTROL**

(71) Applicant: **Universal Electronics Inc.**, Santa Ana, CA (US)

(72) Inventors: **Paul D. Arling**, Irvine, CA (US); **Brian Barnett**, Oakland, CA (US); **Dan N. McKay**, San Jose, CA (US)

(73) Assignee: **Universal Electronics Inc.**, Santa Ana, CA (US)

(*) Notice: Subject to any disclaimer, the term of this patent is extended or adjusted under 35 U.S.C. 154(b) by 1 day.

(21) Appl. No.: **15/060,738**

(22) Filed: **Mar. 4, 2016**

(65) **Prior Publication Data**
US 2016/0191838 A1 Jun. 30, 2016

Related U.S. Application Data

(63) Continuation of application No. 14/036,449, filed on Sep. 25, 2013, now Pat. No. 9,307,178, which is a (Continued)

(51) **Int. Cl.**
G05B 11/01 (2006.01)
H04N 5/44 (2011.01)
(Continued)

(52) **U.S. Cl.**
CPC **H04N 5/4403** (2013.01); **G08C 17/02** (2013.01); **G08C 23/04** (2013.01); **H04B 1/205** (2013.01);
(Continued)

(58) **Field of Classification Search**
CPC H04N 21/4222; H04N 21/42204; H04N 21/42208; H04N 21/42219;
(Continued)

(56) **References Cited**
U.S. PATENT DOCUMENTS
5,959,539 A * 9/1999 Adolph H04B 1/202 340/10.6
6,160,491 A * 12/2000 Kitao G08C 19/28 340/12.28
(Continued)

FOREIGN PATENT DOCUMENTS
EP 1722341 A1 11/2006
WO 2011/053008 A2 5/2011

OTHER PUBLICATIONS
ISA/US, Int. Search Report and Written Opinion of the Int. Searching Authority issued on Int. Appl. No. PCT/US12/62161, received Jan. 23, 2013, 12 pages.
(Continued)

Primary Examiner — Adnan Aziz
(74) *Attorney, Agent, or Firm* — Greenberg Traurig, LLP

(57) **ABSTRACT**
A device receives a request from a controlling device, such as a remote control, smart phone, or the like, where the request is intended to have one or more target devices perform one or more functional operations. The device responds to the request by applying the optimum methodology to propagate one or more commands to each intended target appliance to cause each intended target appliance to perform the intended one or more functional operations.

5 Claims, 13 Drawing Sheets

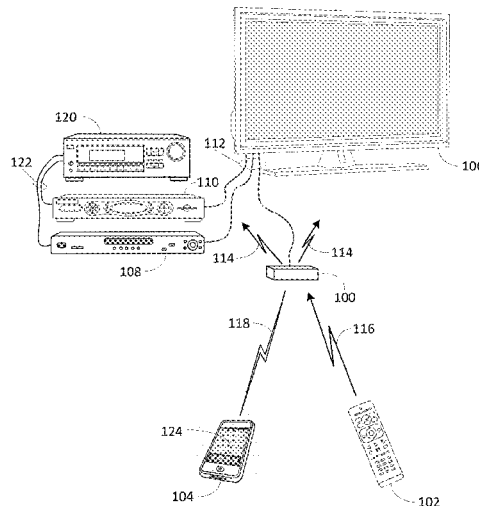

Related U.S. Application Data

- continuation of application No. 13/657,176, filed on Oct. 22, 2012, now Pat. No. 9,215,394.
- (60) Provisional application No. 61/552,857, filed on Oct. 28, 2011, provisional application No. 61/680,876, filed on Aug. 8, 2012.
- (51) **Int. Cl.**
G08C 17/02 (2006.01)
G08C 23/04 (2006.01)
H04B 1/20 (2006.01)
H04N 21/422 (2011.01)
H04N 21/436 (2011.01)
H04N 5/60 (2006.01)
- (52) **U.S. Cl.**
 CPC *H04N 5/60* (2013.01); *H04N 21/4222* (2013.01); *H04N 21/42204* (2013.01); *H04N 21/43615* (2013.01); *G08C 2201/40* (2013.01); *G08C 2201/92* (2013.01); *H04N 2005/4426* (2013.01); *H04N 2005/4435* (2013.01); *H04N 2005/4442* (2013.01)
- (58) **Field of Classification Search**
 CPC H04N 21/42221; H04N 21/42224; H04N 21/42225
 See application file for complete search history.

(56) **References Cited**

U.S. PATENT DOCUMENTS

6,529,556	B1	3/2003	Perdue et al.	
6,968,399	B2	11/2005	Noda et al.	
7,379,778	B2	5/2008	Hayes et al.	
7,519,393	B2	4/2009	Bahl et al.	
7,589,642	B1	9/2009	Mui	
8,203,436	B2*	6/2012	Ikeda	G08C 17/02 340/12.22
8,373,556	B2	2/2013	LaLonde et al.	
2003/0095156	A1	5/2003	Klein et al.	
2004/0163073	A1	8/2004	Krzyzanowski et al.	
2004/0210933	A1	10/2004	Dresti et al.	
2006/0168618	A1	7/2006	Choi	
2006/0227032	A1	10/2006	Vidal	
2007/0296552	A1*	12/2007	Huang	G08C 17/02 340/10.5

2008/0005764	A1	1/2008	Arling et al.	
2008/0231762	A1*	9/2008	Hardacker	H04N 5/4403 348/734
2009/0167555	A1*	7/2009	Kohanek	G08C 17/02 340/3.1
2009/0207039	A1*	8/2009	Hajjima	G08C 17/00 340/4.3
2009/0239587	A1	9/2009	Negron et al.	
2010/0118193	A1*	5/2010	Boyden	G09G 5/006 348/554
2010/0134317	A1	6/2010	Breuil et al.	
2010/0138764	A1	6/2010	Hatambeiki et al.	
2010/0157169	A1*	6/2010	Yoshida	G08C 23/04 348/734
2010/0328547	A1*	12/2010	Mayorga	G06F 13/385 348/734
2011/0102230	A1*	5/2011	Vergis	G08C 19/28 341/176
2011/0122317	A1*	5/2011	Chen	H04N 5/4403 348/563
2011/0273287	A1	11/2011	LaLonde et al.	
2011/0289113	A1	11/2011	Arling et al.	
2012/0041925	A1*	2/2012	Pope	G06F 3/0486 707/626
2012/0084452	A1*	4/2012	Pettit	G08C 17/02 709/230
2012/0242526	A1	9/2012	Perez et al.	
2012/0249890	A1	10/2012	Chardon et al.	
2012/0274547	A1	11/2012	Raeber et al.	
2012/0278693	A1	11/2012	Black et al.	
2012/0291128	A1	11/2012	Jayawardena et al.	
2012/0330943	A1	12/2012	Weber et al.	
2013/0107131	A1	5/2013	Barnett et al.	
2014/0085059	A1	3/2014	Chen et al.	

OTHER PUBLICATIONS

ISA/US, Int. Search Report and Written Opinion of the Int. Searching Authority issued on Int. Appln. No. PCT/US14/38151, received Jun. 27, 2014, 10 pages.

European Patent Office, extended European Search Report issued on European patent application No. 12844121.9, dated Mar. 5, 2015, 6 pages.

European Patent Office, extended European Search Report issued on European patent application No. 14801064.8, dated Apr. 16, 2016, 8 pages.

* cited by examiner

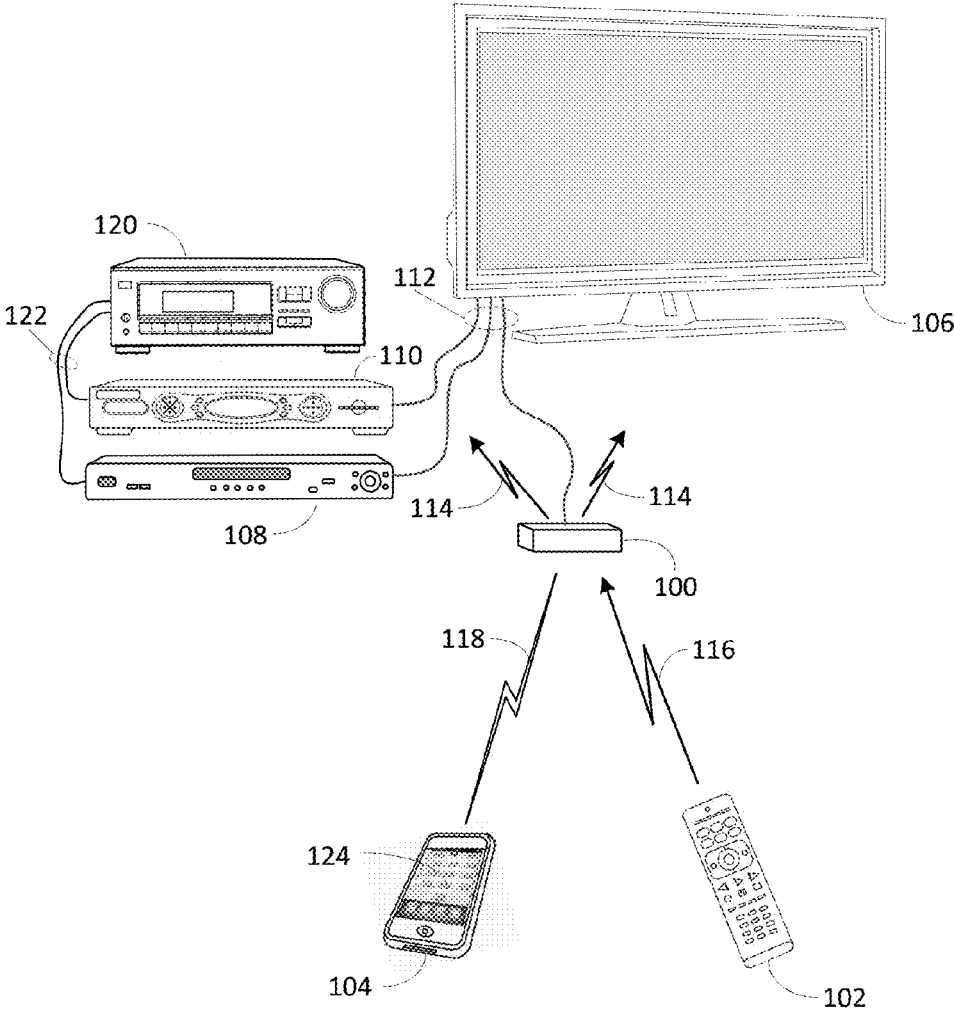

Figure 1

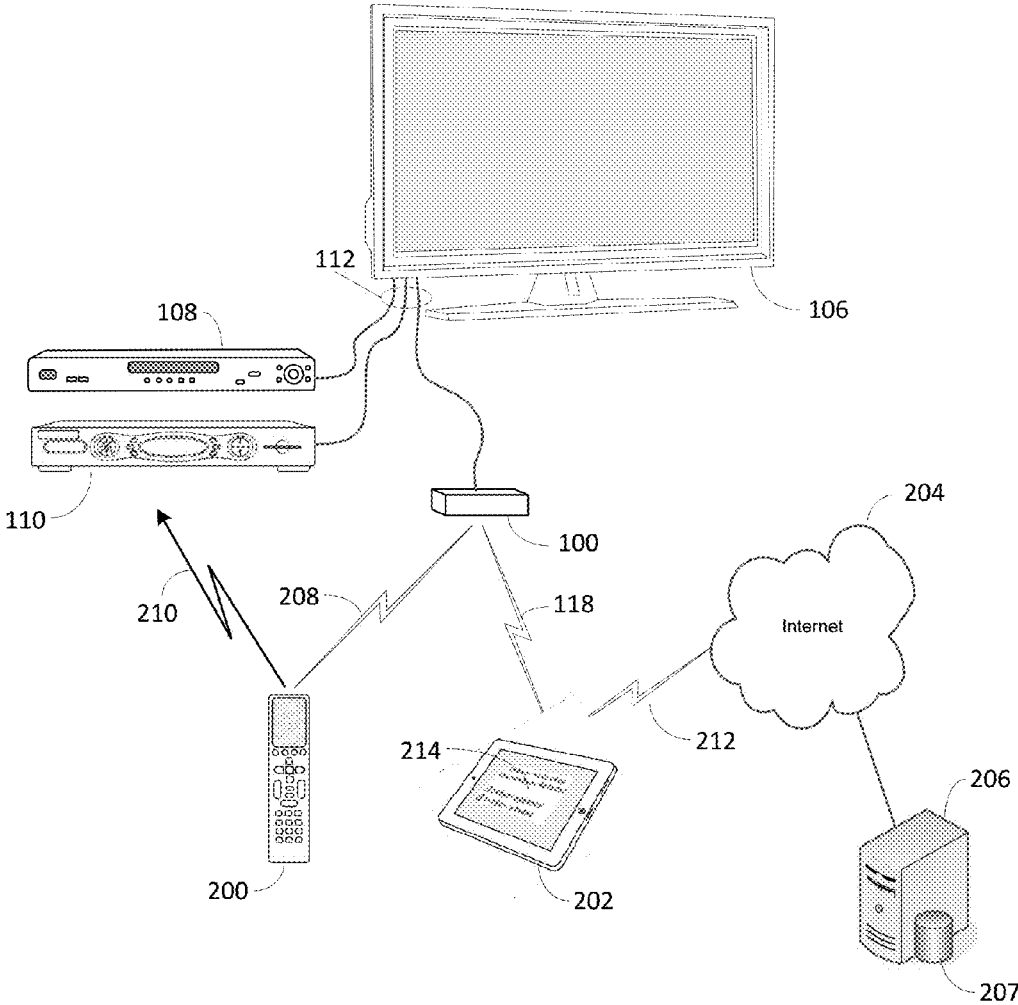

Figure 2

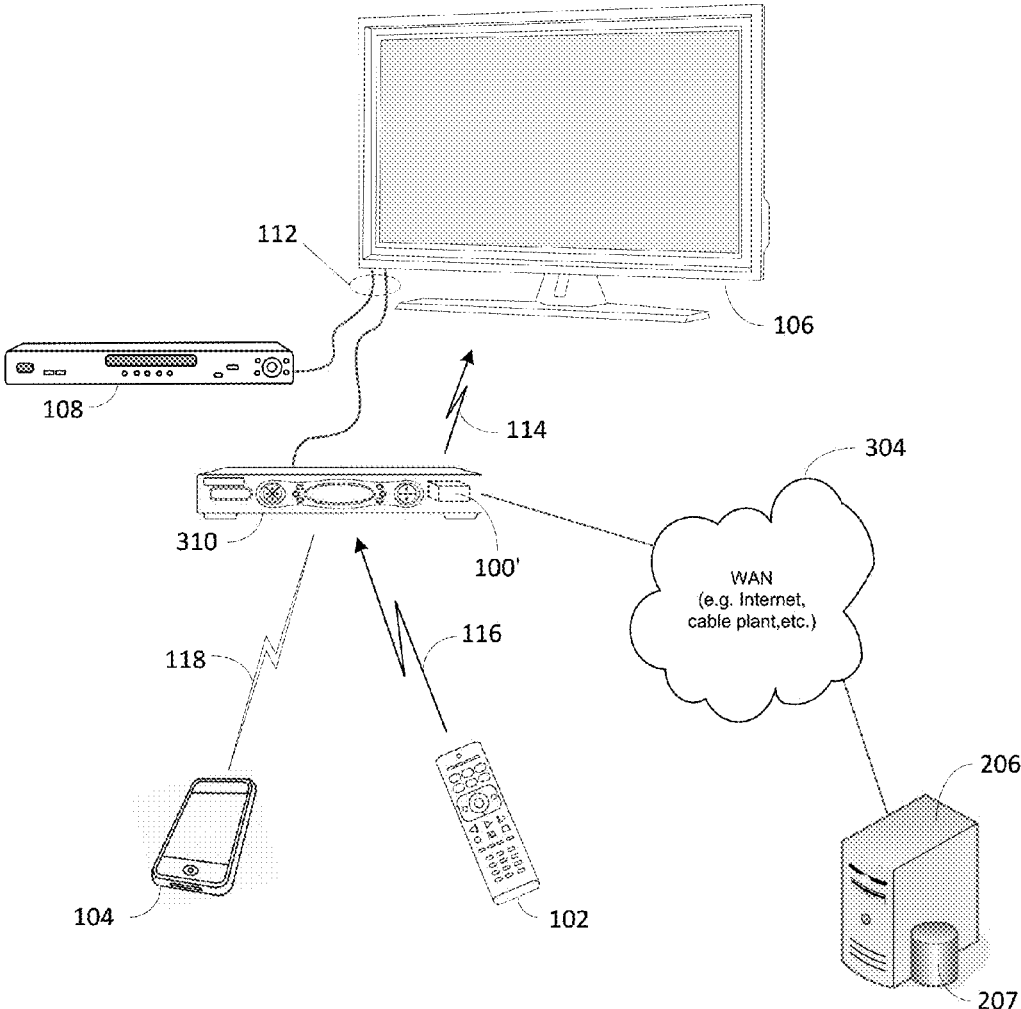

Figure 3

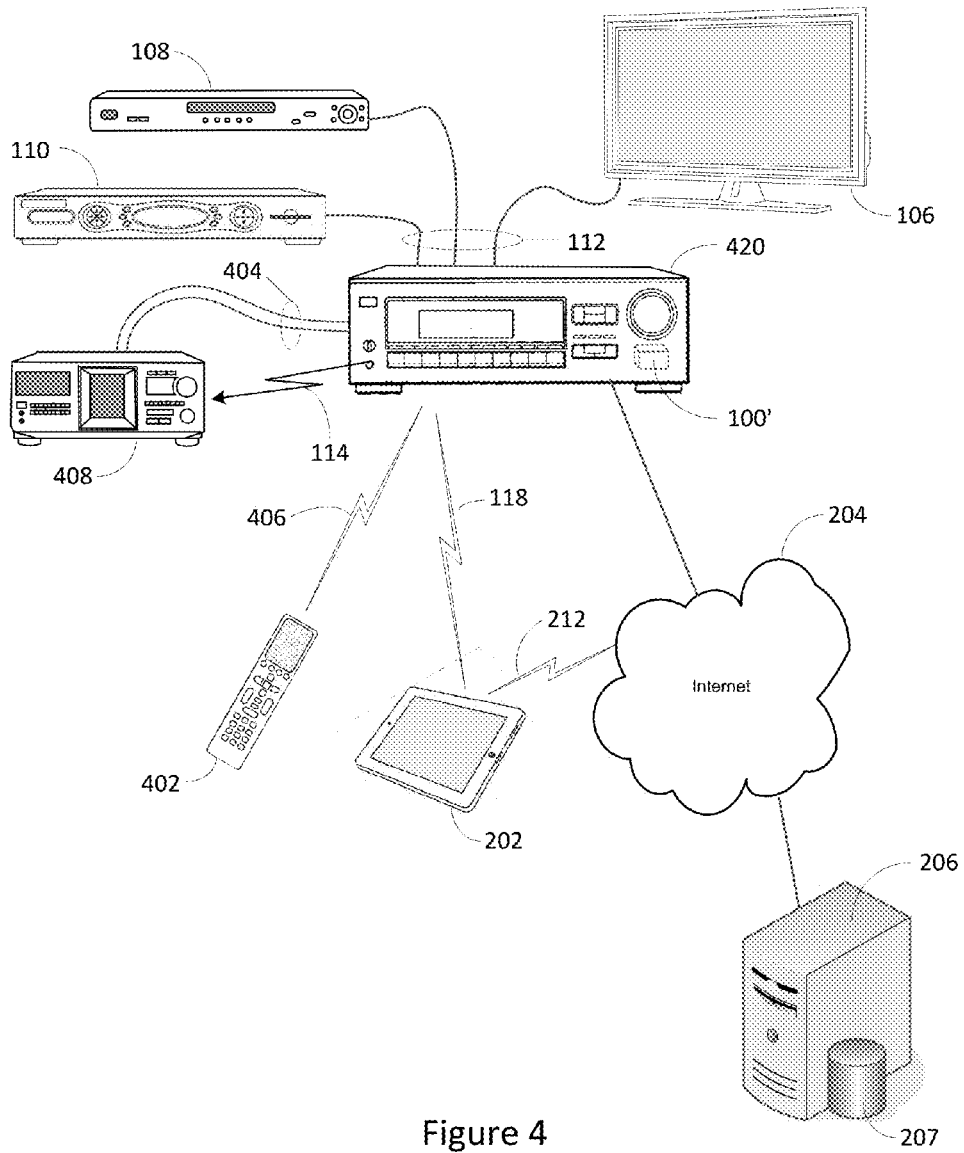

Figure 4

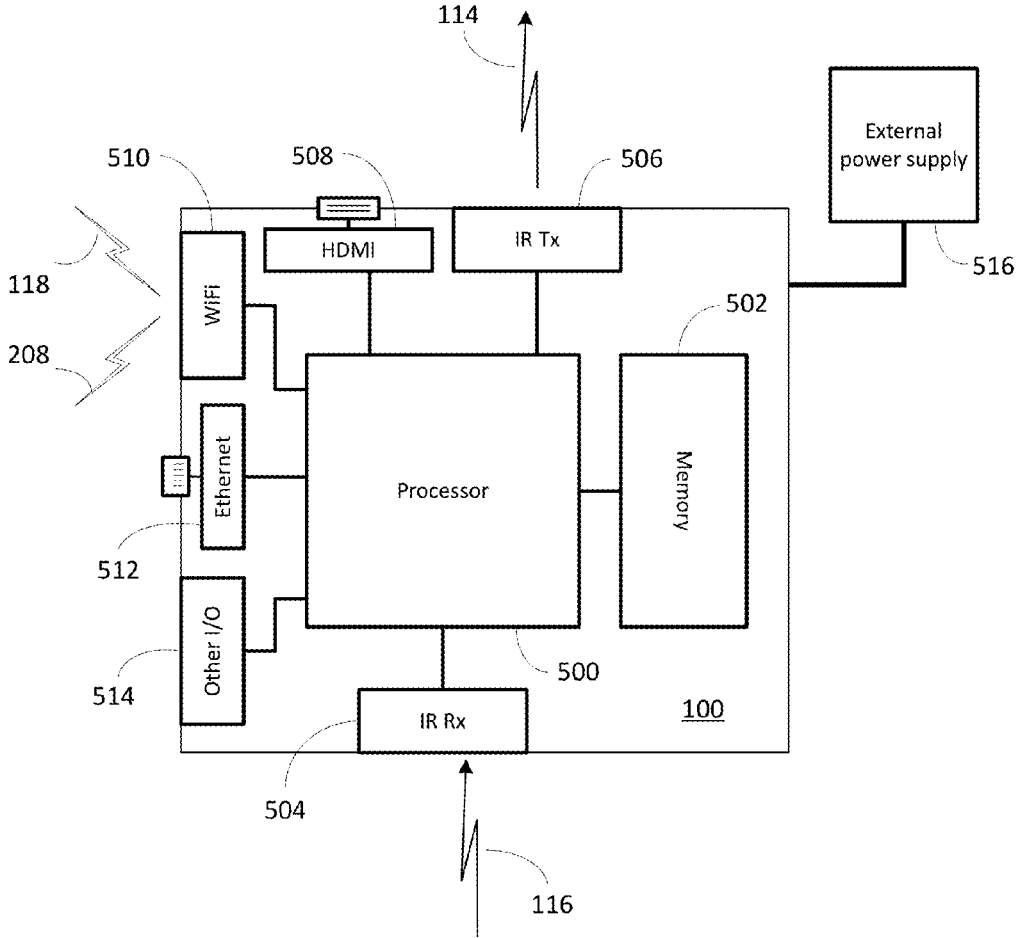

Figure 5

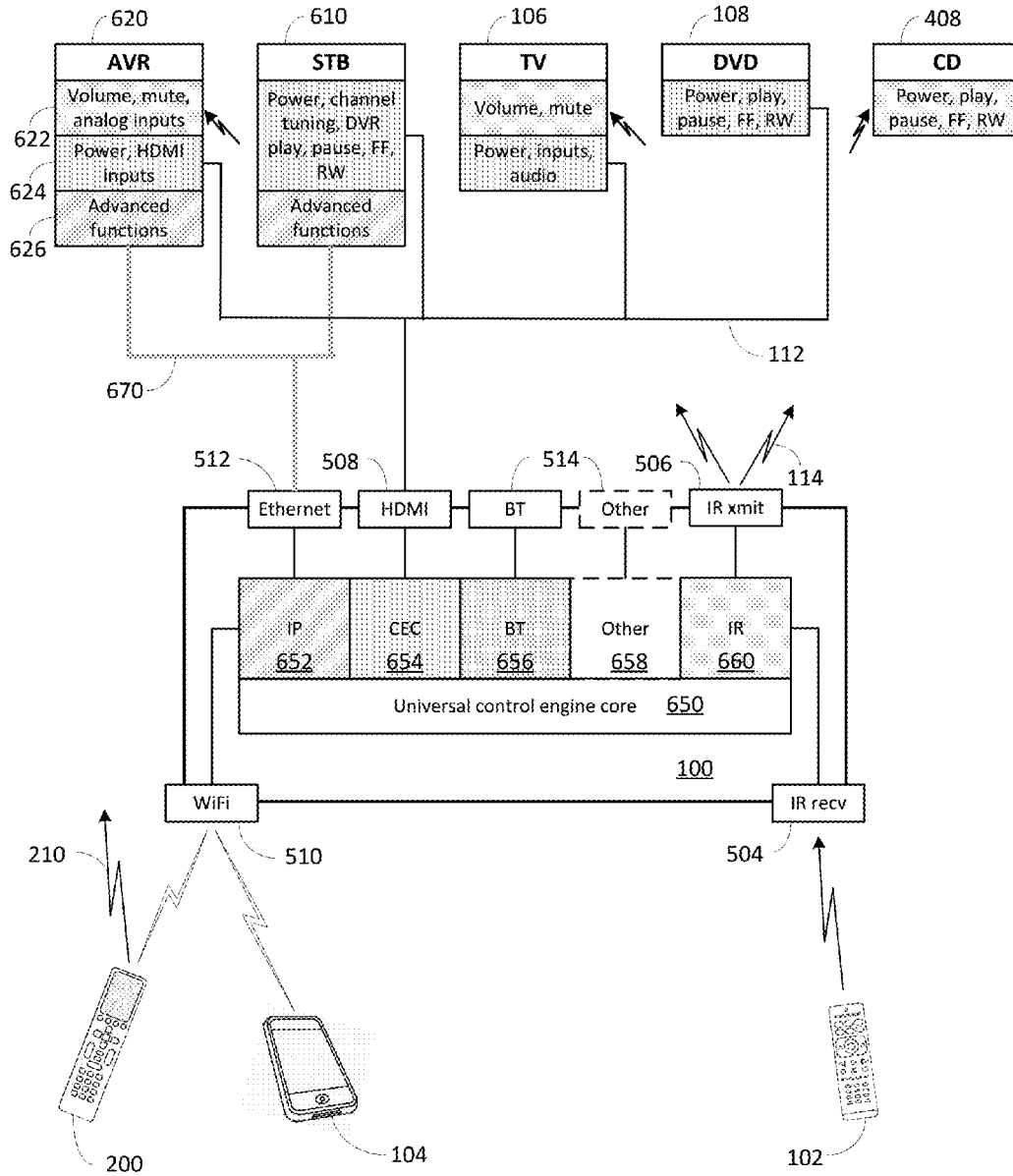

Figure 6

Function	Appliance					
	TV	AVR	STB/DVR	DVD	CD	Etc.....
Power on	CEC	CEC	CEC	CEC	IR	
Power off	CEC	CEC	CEC	CEC	IR	
Volume up	IR	CEC	n/a	n/a	n/a	
Volume down	IR	CEC	n/a	n/a	n/a	
Mute	IR	CEC	n/a	n/a	n/a	
Play	n/a	n/a	CEC	CEC	IR	
Pause	n/a	n/a	CEC	CEC	IR	
FF	n/a	n/a	CEC	CEC	IR	
Rew	n/a	n/a	CEC	CEC	IR	
Sound field A	CEC	IP	IP	n/a	n/a	
Sound field B	CEC	IP	IP	n/a	n/a	
Input 1	CEC	IR	n/a	n/a	n/a	
Input 2	CEC	IR	n/a	n/a	n/a	
Etc.....						

Figure 7

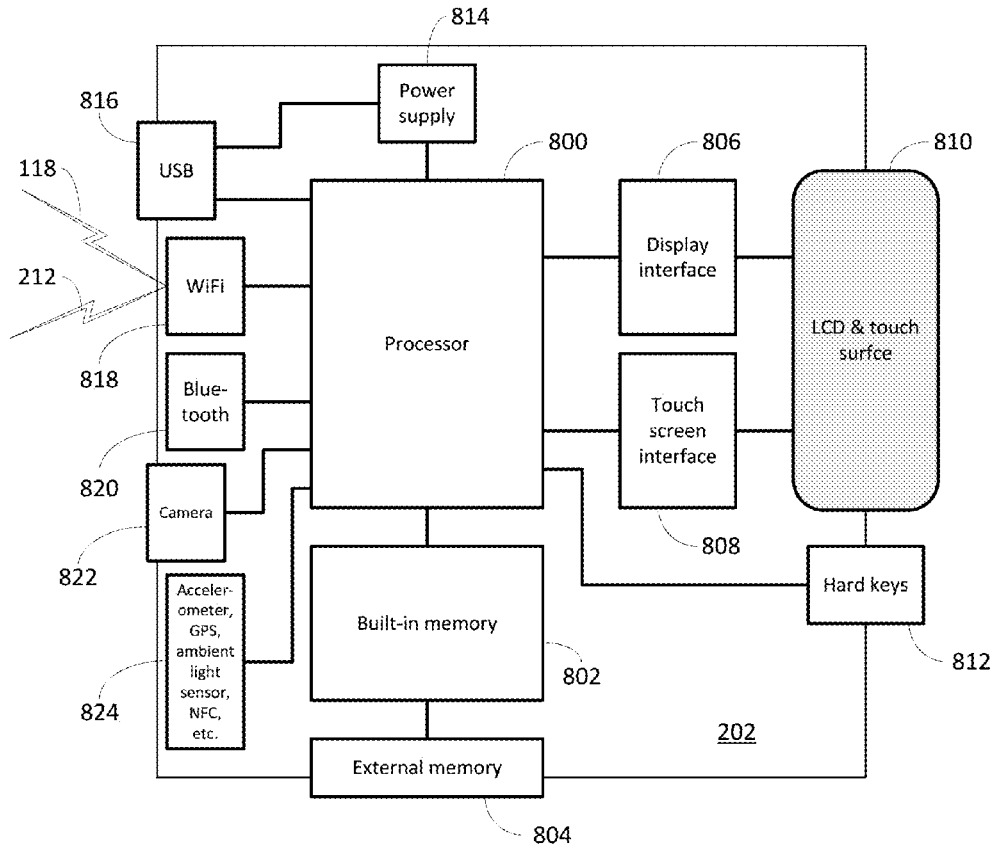

Figure 8

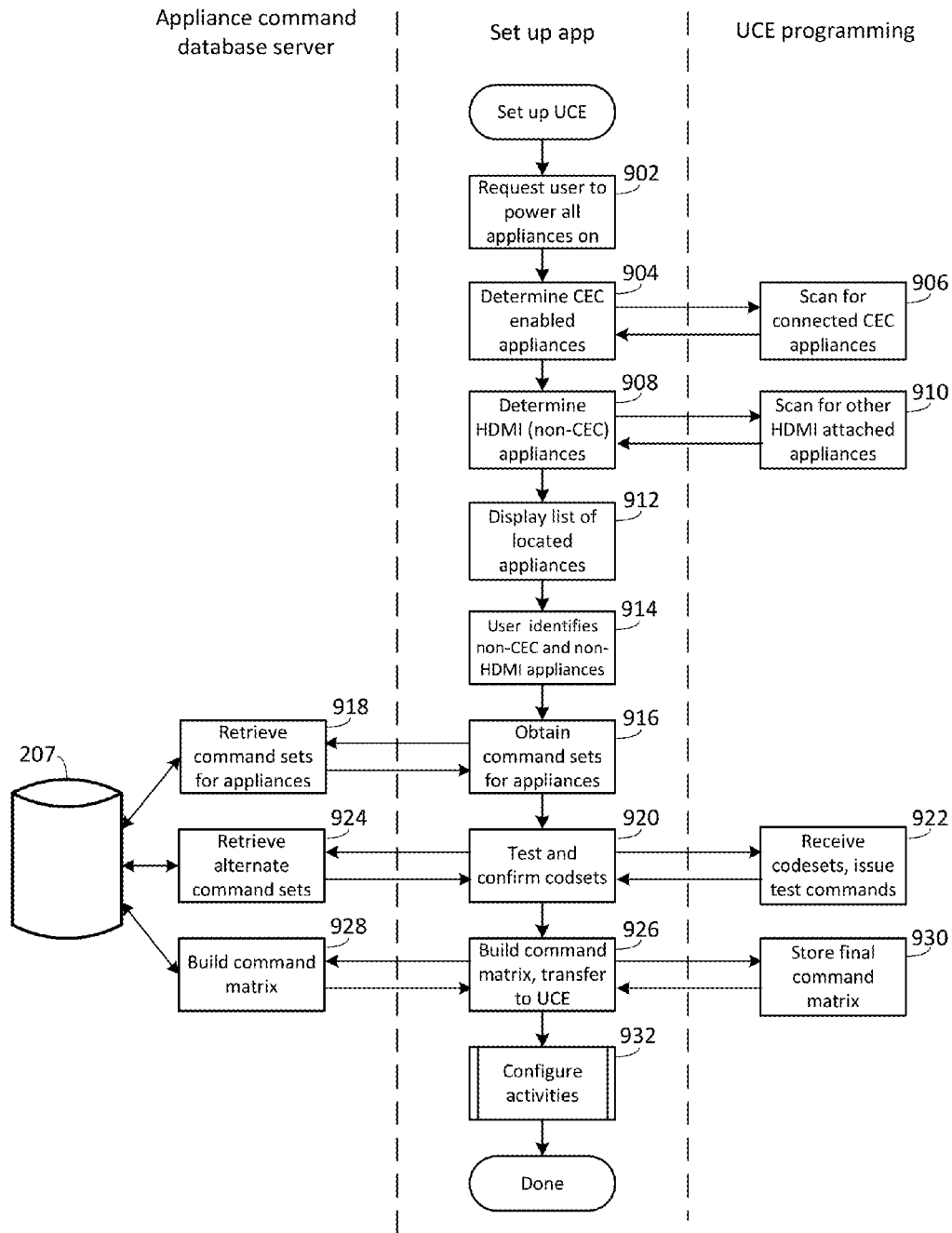

Figure 9

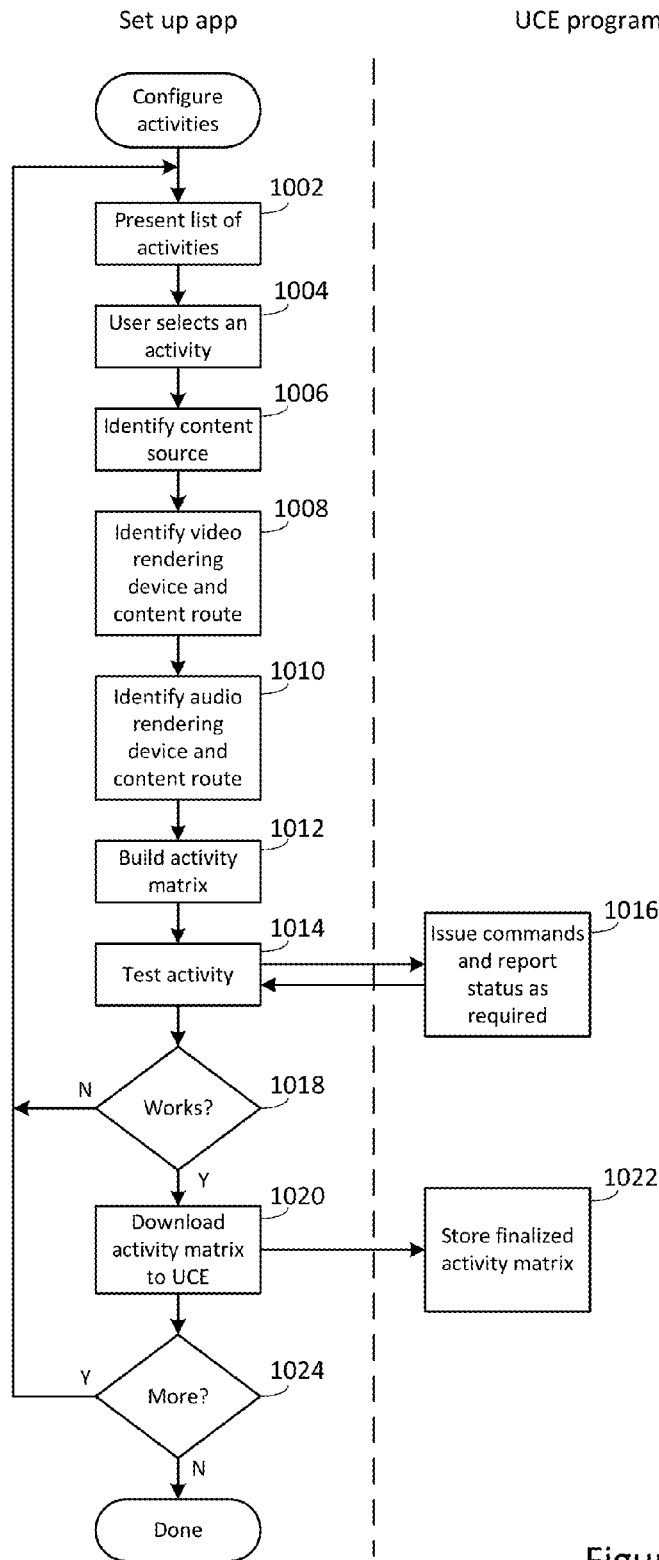

Figure 10

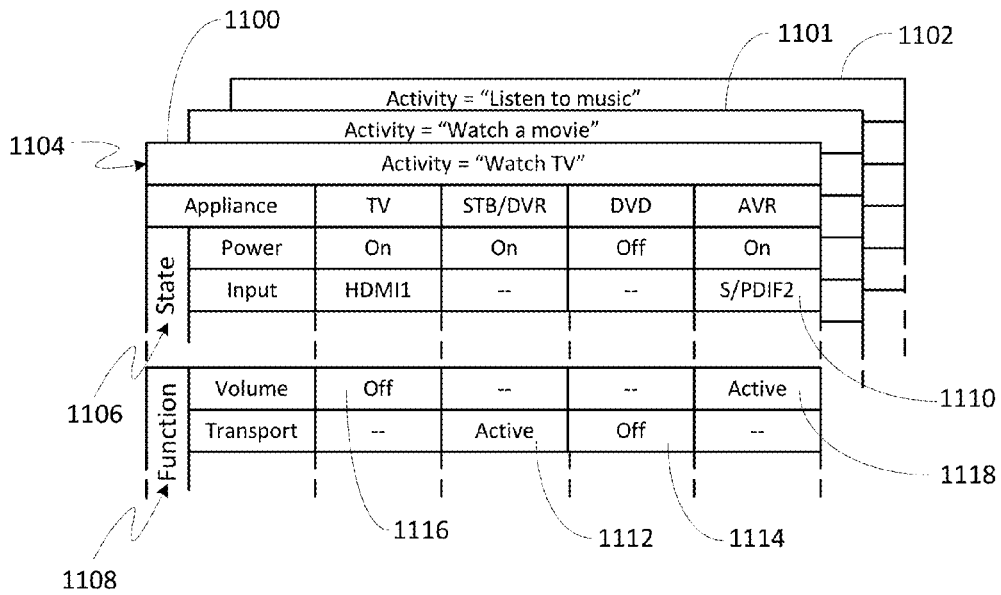

Figure 11

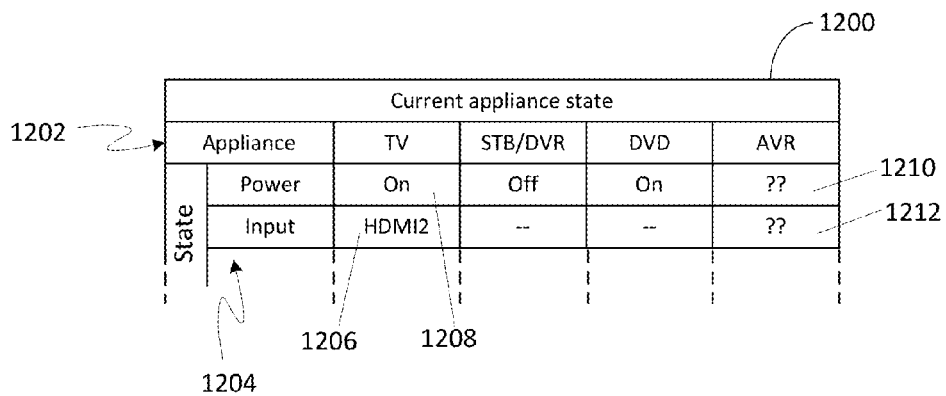

Figure 12

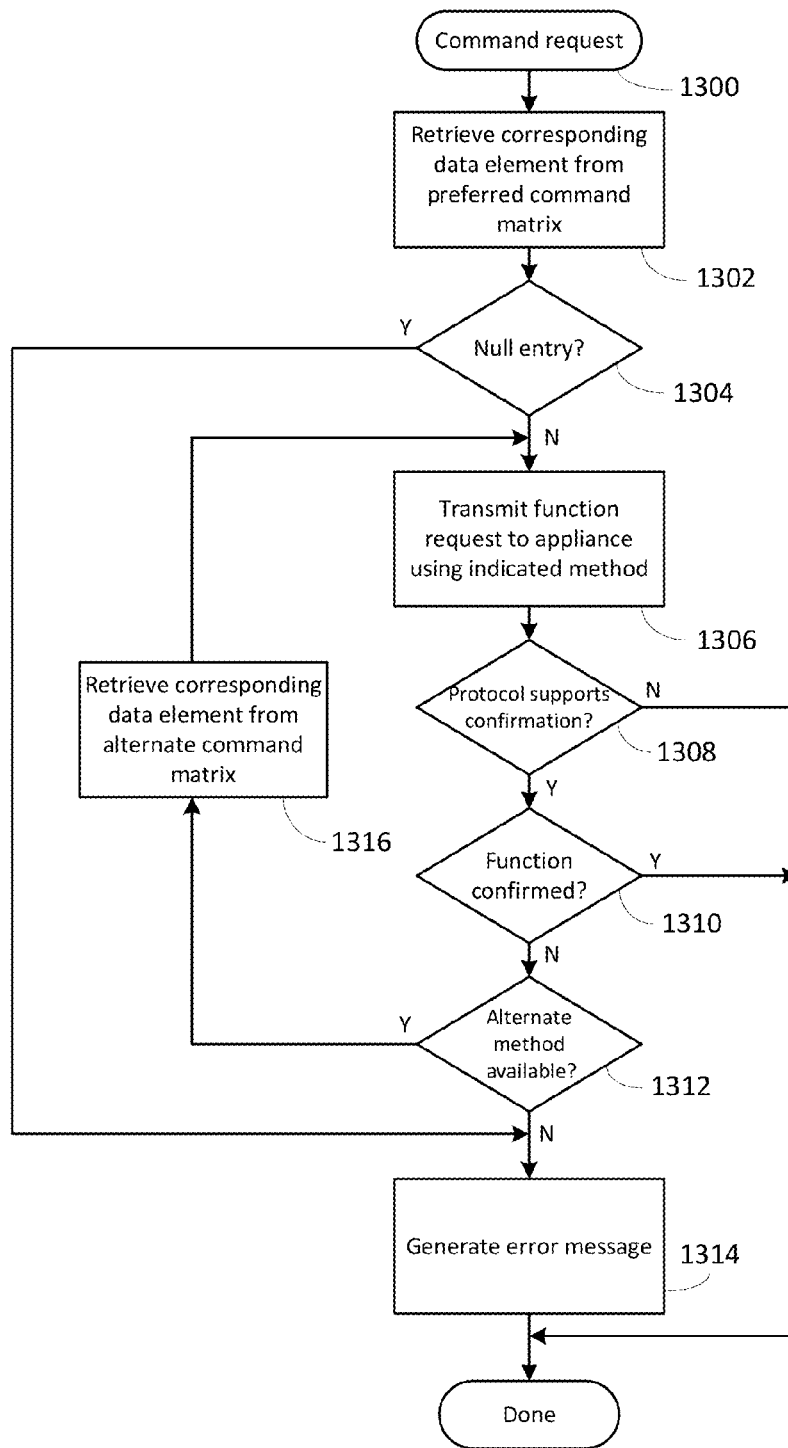

Figure 13

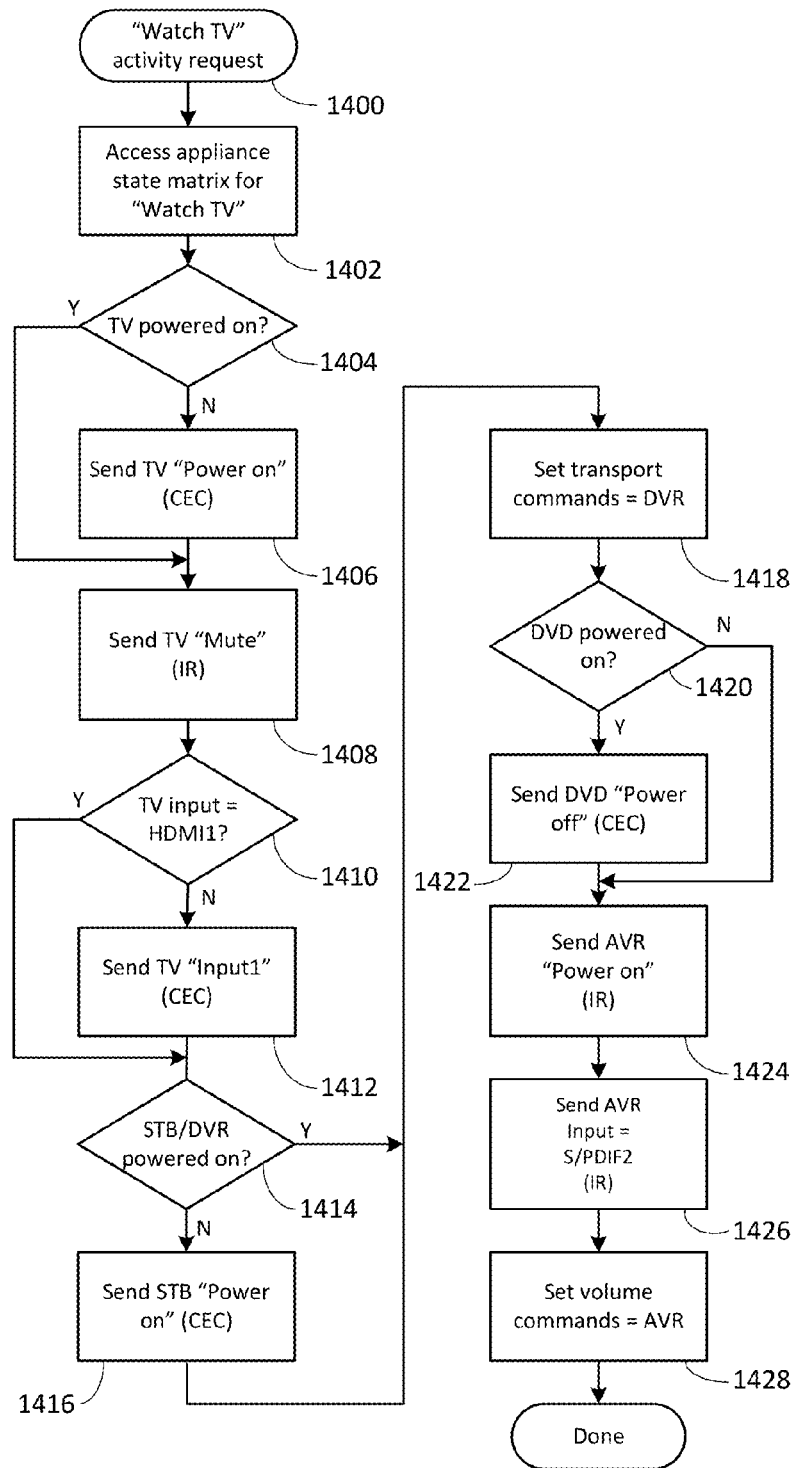

Figure 14

SYSTEM AND METHOD FOR OPTIMIZED APPLIANCE CONTROL

RELATED APPLICATION INFORMATION

This application claims the benefit of and is a continuation of U.S. application Ser. No. 14/036,449, filed on Sep. 25, 2013, which application claims the benefit of and is a continuation of U.S. application Ser. No. 13/657,176, filed on Oct. 22, 2012, which application claims the benefit of U.S. Provisional Application No. 61/552,857, filed Oct. 28, 2011, and U.S. Provisional Application No. 61/680,876, filed Aug. 8, 2012, the disclosures of which are incorporated herein by reference in their entirety.

This application is also related to U.S. patent application Ser. No. 12/621,277, filed on Nov. 18, 2009 and entitled "System and Method for Reconfiguration of an Entertainment System Controlling Device," which in turn is a continuation-in-part of U.S. patent application Ser. No. 12/569,121 (now U.S. Pat. No. 8,243,207), filed on Sep. 29, 2009 and entitled "System and Method for Activity Based Configuration of an Entertainment System," the disclosures of which are incorporated herein by reference in their entirety.

This application is also related to U.S. patent application Ser. No. 13/198,072, filed on Aug. 4, 2011 and entitled "System and Method for Configuring the Remote Control Functionality of a Portable Device," the disclosure of which is incorporated herein by reference in its entirety.

This application is also related to U.S. patent application Ser. No. 13/240,604, filed on Sep. 22, 2011 and entitled "System and Method for Configuring Controlling Device Functionality," the disclosure of which is incorporated herein by reference in its entirety.

BACKGROUND

Controlling devices, for example remote controls, for use in issuing commands to entertainment and other appliances, and the features and functionality provided by such controlling devices are well known in the art. In order to facilitate such functionality, various communication protocols, command formats, and interface methods have been implemented by appliance manufacturers to enable operational control of entertainment and other appliances, also as well known in the art. In particular, the recent proliferation of wireless and wired communication and/or digital interconnection methods such as WiFi, Bluetooth, HDMI, etc., amongst and between appliances has resulted in a corresponding proliferation of such communication protocols and command formats. While many of these newer methods may offer improved performance and/or reliability when compared to previous control protocols, appliance manufacturer adoption of such newer methods remains inconsistent and fragmented. This, together with the large installed base of prior generation appliances, may cause confusion, misoperation, or other problems when a user or manufacturer of a controlling device, such as a remote control, attempts to take advantage of the enhanced features and functionalities of these new control methods.

SUMMARY OF THE INVENTION

This invention relates generally to enhanced methods for appliance control via use of a controlling device, such as a remote control, smart phone, tablet computer, etc., and in particular to methods for taking advantage of improved appliance control communication methods and/or command

formats in a reliable manner which is largely transparent to a user and/or seamlessly integrated with legacy appliance control technology.

To this end, the instant invention comprises a modular hardware and software solution, hereafter referred to as a Universal Control Engine (UCE), which is adapted to provide device control across a variety of available control methodologies and communication media, such as for example various infrared (IR) remote control protocols; Consumer Electronic Control (CEC) as may be implemented over a wired HDMI connection; internet protocol (IP), wired or wireless; RF4CE wireless; Bluetooth (BT) wireless personal area network(s); UPnP protocol utilizing wired USB connections; or any other available standard or proprietary appliance command methodology. Since each individual control paradigm may have its own strengths and weaknesses, the UCE may be adapted to combine various control methods in order to realize the best control option for each individual command for each individual device.

The UCE itself may be adapted to receive commands from a controlling device, for example a conventional remote control or a remote control app resident on a smart device such as a phone or tablet, etc., utilizing any convenient protocol and command structure (IR, RF4CE, BT, proprietary RF, etc.) As will become apparent, the controlling device may range from a very simple unidirectional IR device to a fully functional WiFi enabled smart phone or the like. The UCE may receive command requests from such a controlling device and apply the optimum methodology to propagate the command function(s) to each intended target appliance, such as for example a TV, AV receiver, DVD player, etc. In this manner the UCE may enable a single controlling device to command the operation of all appliances in a home theater system while coordinating available methods of controlling each particular appliance in order to select the best and most reliable method for issuing each command to each given device. By way of example without limitation, a UCE may utilize IR commands to power on an AV receiver appliance while CEC commands or another method may be used to select inputs or power down the same AV receiver appliance; or CEC commands may be used to power on and select inputs on a TV appliance while IR commands may be used to control the volume on the same TV appliance.

As will become apparent, a UCE may comprise modular hardware and software which may be embodied in a stand-alone device suitable for use in an existing home theater equipment configuration, or may be incorporated into any one of the appliances such as a STB, TV, AV receiver, HDMI switch etc. Further, when incorporated into an appliance, UCE functionality may be provisioned as a separate hardware module or may be incorporated together with other hardware functionality, e.g., as part of an HDMI interface IC or chip set, etc.

A better understanding of the objects, advantages, features, properties and relationships of the invention will be obtained from the following detailed description and accompanying drawings which set forth illustrative embodiments and which are indicative of the various ways in which the principles of the invention may be employed.

BRIEF DESCRIPTION OF THE DRAWINGS

For a better understanding of the various aspects of the invention, reference may be had to preferred embodiments shown in the attached drawings in which:

FIGS. 1 and 2 illustrate exemplary systems in which a standalone UEC device may be utilized to command operation of several appliances;

FIGS. 3 and 4 illustrate exemplary systems in which UEC functionality may be incorporated into an appliance which is part of a home entertainment system;

FIG. 5 illustrates a block diagram of an exemplary UEC device;

FIG. 6 illustrates a graphical representation of an exemplary UCE-based control environment;

FIG. 7 illustrates an exemplary preferred command matrix for use in a UCE-based control environment, for example as illustrated in FIG. 6;

FIG. 8 illustrates a block diagram of an exemplary smart device which may support a remote control app and a setup method for use in configuring a UCE;

FIG. 9 illustrates an exemplary series of steps which may be performed in order to set up and configure an exemplary UCE;

FIG. 10 illustrates an exemplary series of steps which may be performed in order to define to a UCE an appliance configuration which corresponds to a user activity;

FIG. 11 illustrates exemplary activity configuration matrices such as may be defined during the steps of FIG. 10;

FIG. 12 illustrates an exemplary current appliance state matrix which may be maintained by a UCE for use in determining the commands necessary to invoke one of the states defined by the matrix of FIG. 11;

FIG. 13 illustrates an exemplary series of steps which may be performed by a UCE in issuing a function command to an appliance; and

FIG. 14 illustrates an exemplary series of steps which may be performed by a UCE in establishing appliance states matching a desired activity defined in one of the matrices of FIG. 11.

DETAILED DESCRIPTION

With reference to FIG. 1, there is illustrated an exemplary system in which a UCE device 100 may be used to issue commands to control various controllable appliances, such as a television 106, a cable set top box combined with a digital video recorder (“STB/DVR”) 110, a DVD player 108, and an AV receiver 120. While illustrated in the context of a television 106, STB/DVR 110, a DVD player 108, and an AV receiver 120, it is to be understood that controllable appliances may include, but need not be limited to, televisions, VCRs, DVRs, DVD players, cable or satellite converter set-top boxes (“STBs”), amplifiers, CD players, game consoles, home lighting, drapery, fans, HVAC systems, thermostats, personal computers, etc. In the illustrative example of FIG. 1, appliance commands may be issued by UCE 100 in response to infrared (“IR”) request signals 116 received from a remote control device 102, radio frequency (“RF”) request signals 118 received from an app 124 resident on a smart device 104, or any other device from which UCE 100 may be adapted to receive requests, using any appropriate communication method. As illustrated, transmission of the requested appliance commands from the UCE to appliances 106, 108, 112, 120 may take the form of wireless IR signals 114 or CEC commands issued over a wired HDMI interface 112, as appropriate to the capabilities of the particular appliance to which each command may be directed. In particular, in the exemplary system illustrated, AV receiver 120 may not support HDMI inputs, being connected to audio source appliances 108, 110 via, for example S/PDIF interfaces 122. Accordingly UCE 100 may be constrained to

transmit all commands destined for AV receiver 120 exclusively as IR signals, while commands destined for the other appliances 106 through 110 may take the form of either CEC or IR signals as appropriate for each command. By way of example without limitation, certain TV manufacturers may elect not to support volume adjustment via CEC. If the illustrative TV 106 is of such manufacture, UCE 100 may relay volume adjustment requests to TV 106 as IR signals 114, while other requests such as power on/off or input selections may be relayed in the form of CEC commands over HDMI connection 112.

It will however be appreciated that while illustrated in the context of IR, RF, and wired CEC signal transmissions, in general, transmissions to and from UCE device 100 may take the form of any convenient IR, RF, hardwired, point-to-point, or networked protocol, as necessary for a particular embodiment. Further, while wireless communications 116, 118, etc., between exemplary devices are illustrated herein as direct links, it should be appreciated that in some instances such communication may take place via a local area network or personal area network, and as such may involve various intermediary devices such as routers, bridges, access points, etc. Since these items are not necessary for an understanding of the instant invention, they are omitted from this and subsequent Figures for the sake of clarity.

Since smart device remote control apps such as that contemplated in the illustrative device 104 are well known, for the sake of brevity the operation, features, and functions thereof will not be described in detail herein. Nevertheless, if a more complete understanding of the nature of such apps is desired, the interested reader may turn to, for example, the before mentioned U.S. patent application Ser. No. 12/406,601 or U.S. patent application Ser. No. 13/329,940, entitled “Graphical User Interface and Data Transfer Methods in a Controlling Device,” both of common ownership and incorporated herein by reference in their entirety.

Turning now to FIG. 2, in a further illustrative embodiment, UCE 100 may receive wireless request signals from a remote control 200 and/or an app resident on a tablet computer 202. As before, command transmissions to appliances 106, 108, 110 may take the form of wired CEC commands or wireless IR commands. However, in this example remote control 200 may be in bi-directional communication 208 with UCE 100 and accordingly the UCE may delegate the transmission of IR commands 210 to the remote control device 200, i.e., use remote control 200 as a relay device for those commands determined to be best executed via IR transmissions. As also generally illustrated in FIG. 2, a setup app 214 executing on a smart device such as tablet computer 202 may be utilized in conjunction with an Internet (212, 204) accessible server 206 and associated database 207 to initially configure UCE 100 for operation with the specific group of appliances to be controlled, i.e., to communicate to UCE 100 a matching command code set and capability profile for each particular appliance to be controlled, for example based on type, manufacture, model number, etc., as will be described in greater detail hereafter.

With reference to FIG. 3, in a yet further illustrative embodiment UCE functionality 100' may be embedded in an appliance, for example STB/DVR 310. In this example, remote control 102 and/or smart device 104 may transmit wireless request signals directly to STB/DVR 310 for action by the built-in UCE function 100', which actions may, as before, comprise CEC command transmissions via HDMI connection 112 or IR command transmissions 114, originating in this instance from an IR blaster provisioned to the

STB/DVR appliance **310**. In this configuration, a set up application resident in STB/DVR **310** may be utilized to configure UCE **100'**, using for example an Internet connection **304** accessible through a cable modem and/or cable distribution system headend.

In the further illustrative embodiment of FIG. **4**, UCE functionality **100'** may be embedded in an AV receiver **420** which may serve as an HDMI switch between various content sources such as a STB/DVR **110** or a DVD player **108** and a rendering device such as TV **106**. In addition to HDMI inputs, AV receiver **420** may also support various other input formats, for example analog inputs such as the illustrative **404** from CD player **408**; composite or component video; S/PDIF coaxial or fiberoptic; etc. In this embodiment, request signals **406** may be directed to AV receiver **420**, for example from remote control **402**, for action by UCE function **100'**. As before, resulting appliance commands may be transmitted using CEC signals transmitted over HDMI connections **112**, or via IR signals **114** transmitted from an associated IR blaster. As appropriate for a particular embodiment, initial configuration of UCE **100'** to match the equipment to be controlled may be performed by an Internet-connected app resident in AV receiver **420**, or by an app resident in tablet computer **202** or other smart device, as mentioned previously in conjunction with FIG. **2**.

As will be appreciated, various other configurations are also possible without departing from the underlying UCE concept, for example UCE function **100'** may be incorporated into an Internet-capable TV, an HDMI switch, a game console, etc.; appliance command set and capability database **207** may be located at a cable system headend, may be stored locally (in all or in part), which local storage may take the form of internal memory within the UCE itself or in an appliance such as a TV, STB or AV receiver, or may take the form of a memory stick or the like attachable to a smart device or appliance; etc.

With reference to FIG. **5**, an exemplary UCE device **100** (whether stand alone or an appliance supporting UCE functionality) may include, as needed for a particular application, a processor **500** coupled to a memory **502** which memory may comprise a combination of ROM memory, RAM memory, and/or non-volatile read/write memory and may take the form of a chip, a hard disk, a magnetic disk, an optical disk, a memory stick, etc., or any combination thereof. It will also be appreciated that some or all of the illustrated memory may be physically incorporated within the same IC chip as the processor **500** (a so called "micro-controller") and, as such, it is shown separately in FIG. **5** only for the sake of clarity. Interface hardware provisioned as part of the exemplary UCE platform may include IR receiver circuitry **504** and IR transmitter circuitry **506**; an HDMI interface **508**; a WiFi transceiver and interface **510**; an Ethernet interface **512**; and any other wired or wireless I/O interface(s) **514** as appropriate for a particular embodiment, by way of example without limitation Bluetooth, RF4CE, USB, Zigbee, Zensys, X10/Insteon, HomePlug, HomePNA, etc. The electronic components comprising the exemplary UCE device **100** may be powered by an external power source **516**. In the case of a standalone UCE device such as illustrated in FIG. **1** or **2**, this may comprise for example a compact AC adapter "wall wart," while integrated UCE devices such as illustrated in FIG. **3** or **4** may draw operating power from the appliance into which they are integrated. It will also be appreciated that in the latter case, in certain embodiments processor **500** and/or memory **502**

and/or certain portions of interface hardware items **504** through **514** may be shared with other functionalities of the host appliance.

As will be understood by those skilled in the art, some or all of the memory **502** may include executable instructions that are intended to be executed by the processor **500** to control the operation of the UCE device **100** (collectively, the UCE programming) as well as data which serves to define the necessary control protocols and command values for use in transmitting command signals to controllable appliances (collectively, the command data). In this manner, the processor **500** may be programmed to control the various electronic components within the exemplary UCE device **100**, e.g., to monitor the communication means **504,510** for incoming request messages from controlling devices, to cause the transmission of appliance command signals, etc. To cause the UCE device **100** to perform an action, the UCE device **100** may be adapted to be responsive to events, such as a received request message from remote control **102** or smart device **104**, changes in connected appliance status reported over HDMI interface **508**, WiFi interface **510**, or Ethernet interface **512**, etc. In response to an event, appropriate instructions within the UCE programming may be executed. For example, when a command request is received from a smart phone **104**, the UCE device **100** may retrieve from the command data stored in memory **502** a preferred command transmission medium (e.g., IR, CEC over HDMI, IP over WiFi, etc.) and a corresponding command value and control protocol to be used in transmitting that command to an intended target appliance, e.g., TV **106**, in a format recognizable by that appliance to thereby control one or more functional operations of that appliance. By way of further example, the status of connected appliances, e.g., powered or not powered, currently selected input, playing or paused, etc., as may be discerned from interfaces **508** through **514**, may be monitored and/or tabulated by the UCE programming in order to facilitate adjustment of appliance settings to match user-defined activity profiles, e.g. "Watch TV", "View a movie", etc.

An overview of an exemplary UCE control environment is presented in FIG. **6**. The UCE programming of an exemplary UCE device **100** may comprise a universal control engine core **650** together with a series of scalable software modules **652** through **660**, each module supporting a particular appliance command protocol or method and provisioned as appropriate for a particular embodiment. By way of example, the illustrative embodiment of FIG. **6** may include an internet protocol (IP) module **652**, a CEC over HDMI module **654**, a Bluetooth module **656**, an IR module **660**, and other modules(s) **658**, as appropriate for the particular application. The appliances to be controlled may include an IP enabled AV receiver **620**, an IP enabled STB/DVR **610**, TV **106**, DVD player **108**, and CD player **408**. As illustrated, certain of these devices may be interconnected via HDMI **112** and/or Ethernet **670** interfaces. (In this regard, it should be appreciated that the illustrative interconnections **112** and **670** of FIG. **6** are intended to depict logical topography only, and accordingly details of exact physical cabling structure and/or the presence of any necessary switches, routers, hubs, repeaters, interconnections, etc., are omitted for the sake of clarity.)

The preferred method/protocol/medium for issuance of commands to the exemplary appliances of FIG. **6** may vary by both appliance and by the function to be performed. By way of example, volume control and analog input selection commands **622** targeted to AV receiver **620** may be required to be issued via IR transmissions, while power on/off and

HDMI input selection functionality commands **624** may be better communicated via CEC commands and advanced functionality commands **626** such as sound field configuration may be best communicated via an Ethernet connection. In a similar manner, the various operational functions of the other appliances may best commanded via a mixture of mediums, methods, and protocols, as illustrated. As will be appreciated, in some instances a particular appliance may support receipt of an operational command via more than one path, for example the power on/off function of AV receiver **620** may be available not only as a CEC command, but also via an IR command. In such instances, the UCE preferred command format may be that which has been determined to offer the greatest reliability, for example in the above instance the CEC command may be preferred since this form of command is not dependent on line-of-sight and also permits confirmation that the action has been performed by the target appliance.

In order to determine the optimum method for each configured appliance type and command, the exemplary UCE core program **650** may be provisioned with a preferred command matrix **700**, as illustrated in FIG. 7. Exemplary preferred command matrix **700** may comprise a series of data cells or elements, e.g. cells **712**, each corresponding to a specific command **702** and a specific one of the appliances to be controlled **704**. The data content of such a cell or element may comprise identification of a form of command/transmission to be used and a pointer to the required data value and formatting information for the specific command. By way of example, the data element **712** corresponding to the "Input 2" command **706** for the configured TV appliance **708**, may comprise an indicator that a CEC command is to be used, i.e., an indicator of the transmission device that is to be used to communicate the command to the intended target appliance, together with a pointer to the appropriate command data value and HDMI-CEC bus address; while data element **714** corresponding to the same command function for the configured AV receiver **710** may comprise an indicator that an IR command is to be used, together with a pointer to appropriate command data and formatting information within an IR code library stored elsewhere in UCE memory **502**. In certain embodiments one or more secondary command matrices **716** may also be provisioned, allowing for the use of alternate command methods in the event it is determined by the UCE programming that a preferred command was unsuccessful. Command matrix **700** may also contain null entries, for example **718**, where a particular function is not available on or not supported by a specific appliance. In an exemplary embodiment, command matrix **700** may be created and loaded into the memory **502** of UCE **100** during an initialization and set-up process, as will now be described in further detail.

In order to perform initial configuration of a UCE device, a setup application may be provided. In some embodiments, such a set up application may take the form of programming to be executed on any convenient device with a suitable user interface and capable of establishing communication with the UCE, such as without limitation a smart phone, tablet computer, personal computer, set top box, TV, etc., as appropriate for a particular embodiment. In other embodiments such a set up application may be incorporated into the UCE programming itself, utilizing for example a connected TV screen and an associated controlling device as the user interface. Regardless of the exact form and location of the programming and user interface means, the series of steps which may be performed by a UCE set up application when configuring a UCE device for operation with a specific set of

appliances remains similar. Accordingly, it will be appreciated that the methods comprising the illustrative UCE set up application presented below in conjunction with FIGS. **8** and **9** may be generally applied, mutatis mutandis, to various alternative set up application embodiments.

With reference to FIG. **8**, as known in the art a tablet computer such as the exemplary device **202** of FIG. **2** may comprise, as needed for a particular application, a processor **800** memory **802** which memory may comprise a combination of ROM memory, RAM memory, and/or non-volatile read/write memory and may take the form of a chip, a hard disk, a magnetic disk, an optical disk, a memory stick, etc., or any combination thereof. In some embodiments, provision may also be made for attachment of external memory **804** which may take the form of an SD card, memory stick, or the like. Hardware provisioned as part of an exemplary tablet computer platform may include an LCD touchscreen **810** with associated display driver **806** and touch interface **808**; hard keys **812** such as for example a power on/off key; a USB port **816**; WiFi transceiver and interface **818**; a Bluetooth transceiver and interface **820**; a camera **822**; and various other features **824** as appropriate for a particular embodiment, for example an accelerometer, GPS, ambient light sensor, near field communicator; etc. The electronic components comprising the exemplary tablet computer device **202** may be powered by a battery-based internal power source **814**, rechargeable for example via USB interface **816**.

Memory **802** may include executable instructions that are intended to be executed by the processor **800** to control the operation of the tablet computer device **202** and to implement various functionalities such as Web browsing, game playing, video streaming, etc. As is known in the art, programming comprising additional functionalities (referred to as "apps") may be downloaded into tablet computer **202** via, for example, WiFi interface **818**, USB **816**, external memory **804**, or any other convenient method. As discussed previously, one such app may comprise a remote control app, for example as that described in co-pending U.S. patent application Ser. No. 13/329,940 of like assignee and incorporated herein by reference in its entirety, which app may be for use in commanding the operation of appliances **106**, **108**, **110** and/or **120** via UCE device **100**. In order to initially configure UCE device **100** to match the appliances to be controlled and to establish an appropriate command matrix, tablet computer **202** may also be provisioned with a setup app **214**, either as part of a remote control app or as separately downloadable item.

With reference now to FIG. **9** such a setup app, upon being invoked at step **902** may initially request that the user place all of the appliances to be controlled into a known state, e.g., powered on, in order to enable the appliance detection and/or testing steps which follow. Next, at step **904** the setup app may determine the identity of those appliances which are CEC-enabled. This may be accomplished by communicating a request to the associated UCE, which at step **906** which may cause the UCE programming to scan connected HDMI devices for appliances which are CEC-enabled and/or identifiable via interaction over the HDMI interface, for example as described in co-pending U.S. patent application Ser. No. 13/198,072, of like assignee and incorporated herein by reference in its entirety, and communicate such appliance identities to the setup application. Thereafter, at step **904** the setup application may determine if additional non-CEC appliances are connected to the UCE device via the HDMI interface. This may be accomplished by requesting the UCE programming to scan for any further

HDMI connections at step **910** and communicate the findings back to the setup application. Though not illustrated, it will be appreciated that where appropriate for a particular embodiment the UCE programming may conduct similar scans to in order to discover appliances connected via Ethernet, USB, Bluetooth, RF4CE, WiFi etc., where such interfaces may be provisioned to a UCE.

Thereafter, at step **912** the setup application may display a listing of detected appliances (both identified and not yet identified) to the user. At step **914**, the user may be prompted to enter appliance identifying information for those HDMI or otherwise connected appliances which were detected but not identified, as well as identifying information regarding any additional appliances which may form part of the system to be controlled but are not discoverable as described above (for example appliances such as AV receiver **120** or CD player **408** which may be responsive only to unidirectional IR commands). Without limitation, such identifying information may take the form of user-entered data such as an appliance type, brand and model number, or a setup code from a listing in a user guide; or may take the form of scanned or electronic information such as a digital picture of the appliance itself or of a bar code, QR code, or the like associated with appliance; near field acquisition of RFID tag data; etc.; or any combination thereof as appropriate for a particular embodiment.

Once appropriate identifying information has been acquired, at step **916** the setup app may communicate that information to a database server, for example server **206**, for performance of step **918**, comprising identification of and retrieval of command codeset and capability data corresponding to the identified appliances from a database **207**, and provision of this data to the setup application for processing and ultimate transfer to the UCE device. As will be appreciated, the transferred codeset data may comprise complete command data values and formatting information, may comprise pointers to command data values and formatting information already stored in the memories **502** and/or **802/804** of the UCE or the device upon which the setup application is currently resident, or a combination thereof. Where necessary, for example when database **207** may contain alternate codesets for an identified appliance, or where uncertainty exists regarding a particular appliance model number, etc., at steps **920**, **922**, and **924** various control paradigms and/or command data sets may be tested against the appliances to be controlled. Such testing may take the form of soliciting user response to effects observable commands, monitoring of HDMI interface status changes as described for example in U.S. patent application Ser. No. 13/240,604, of like assignee and incorporated herein by reference in its entirety, or any other method as convenient for a particular application. Once appropriate codesets have been fully determined, at steps **926,928** and **930** a suitable preferred command matrix, for example as illustrated in FIG. 7, may be constructed and stored into the memory **502** of exemplary UCE device **100**, the matrix being constructed by considering the communication capabilities and functionalities of the devices identified via the above-described processes.

In order to select the optimum command method for each function of each configured appliance any suitable method may be utilized, for example a system-wide prioritization of command media and methods by desirability (e.g. apply IP, CEC, IR in descending order); appliance-specific command maps by brand and/or model; function-specific preference and/or priority maps (e.g. all volume function commands via IR where available); etc.; or any combination thereof. The

exact selection of command method priorities or mapping may take into account factors such connection reliability, e.g. wired versus wireless, bidirectional versus unidirectional communication, etc.; speed of command transmission or execution; internal priorities within an appliance, e.g. received IP received packets processed before CEC packets, etc.; type of protocol support (e.g. error correction versus error detection; ack/nak, etc.); or any other factors which may be applied in order to achieve optimum performance of a particular embodiment.

As will be appreciated, the construction of said preferred command matrix may be performed at the database server or within the setup application, or a combination thereof, depending on the particular embodiment. Once a preferred command matrix has been finalized and stored in the UCE device, at step **932** a series of desired appliance configurations associated with specific user activities may be configured and stored into the UCE device, as will be now be described.

Upon completion and storage of a preferred command matrix, an exemplary setup application may subsequently guide a user through a series of steps in order to establish the desired appliance configurations for a series of possible activities. With reference to FIG. 10, at step **1002**, the user may be presented with a list of possible activities, e.g., "Watch TV", "Watch a movie", "Listen to music", etc. In some embodiments, the user may also be able to edit activity titles and/or create additional user defined activities. At step **1004** a user may select a particular activity for configuration, for example "Watch TV". At step **1006**, the user may be prompted to identify the content source for the activity being configured, for example cable STB/DVR **110** for the exemplary "Watch TV" activity. Such a prompt may take the form of a listing of eligible appliances as determined during the foregoing appliance set up steps; explicit user entry of an appliance type; etc. Next, at steps **1008** the user may be prompted in a similar manner to select video and audio rendering appliances for use in this activity, for example TV **106** and AVR receiver **120** respectively. Depending upon the system topography and the interfaces in use (i.e. HDMI/CEC, IP, analog, etc.) the set up application in concert with UCE programming may be able to ascertain which input port of each rendering appliance is attached to the content source appliance identified for this activity and/or if any intermediate switching appliance is in use (for example AV receiver **420** of the system illustrated in FIG. 4). Where such information is obtainable, the set up application may automatically create all or part of an appropriate rendering device input selection for the activity being configured. If not, at steps **1008** and **1010**, the user may be additionally requested to identify the applicable content route(s) to the rendering appliances, e.g., input port numbers, presence of intermediate switches, etc. During or upon conclusion of steps **1004** through **1010**, the set up application may construct an activity matrix, for example as illustrated in FIG. 11. By way of example, activity matrix **1100** for a "Watch TV" activity may comprise a series of cells, for example **1110** or **1112**, each corresponding to a desired configuration of a particular state **1106** or function **1108** of a specific appliance **1104** during the specified activity. By way of example, cell **1110** may indicate that the input of AV receiver **120** is to be set to "S/PDIF2", while cells **1112** and **1114** may indicate that transport function commands (e.g., "play", "pause", "fast forward" etc.) are to be directed to STB/DVR **110** and not to DVD **114**. In this regard, it will be appreciated that while in some embodiments the assignment of functions such as, for example, volume control, to specific appliances

11

during a particular activity may be performed within an individual controlling device, i.e., the controlling device may determine the appliance to which volume control commands are to be directed, in a preferred embodiment this assignment may be performed within the UCE, thereby ensuring consistency across each activity when multiple controlling devices are present in an environment, for example devices **102** and **104** of the environment illustrated in FIG. 1.

Returning now to FIG. 10, at steps **1014** and **1016** the newly-constructed activity matrix **1100** may be tested by causing the UCE programming, utilizing preferred command matrix **700**, to issue the commands necessary to place the identified appliances into the desired state and thereafter receiving verification at step **1018** that the desired activity was successfully initiated. It will be appreciated that such verification may comprise, for example, detection and reporting of HDMI or other content streams and/or appliance status by UCE programming by directly monitoring CEC status or by using methods such as described for example in U.S. patent application Ser. No. 13/240,604; solicitation of user input confirming correct operation; monitoring for presence or absence of analog input signals; recording of appliance status or error messages; etc.; or any combination thereof as appropriate for a particular embodiment.

If testing is unsuccessful, at step **1018** the set up application may return to step **1002** to allow reconfiguration of that activity and/or definition of alternative activities. If testing was successful, at steps **1020** and **1022** the completed activity matrix, for example **1100** as illustrated in FIG. 11, may be transferred to the UCE **100** for storage in UCE memory **502**. Thereafter, at step **1024** the user may be offered the opportunity to return to step **1002** to define additional activity configurations, for example **1101,1102** as illustrated in FIG. 11, or to exit the activity configuration process.

With reference now to FIG. 13, the series of steps performed by the UCE programming in order to convey a function command to an appliance in accordance with a command request **1300** received from a controlling device such as remote control **102** or **200**, smart device **104** or **202**, etc., or in accordance with an internally generated requirement resulting from receipt of an activity request (as will be described hereafter) may initially comprise retrieval from a preferred command matrix that data element which corresponds to the requested command and target appliance. By way of specific example, receipt of a "TV power on" request from remote control **102** or the like at a UEC provisioned with the preferred command matrices illustrated in FIG. 7 may cause retrieval of data element **720**, indicating that the command is to be communicated to the TV appliance, e.g., television **106**, using an HDMI CEC command. At step **1304**, the UCE programming may determine if the retrieved value constitutes a null element. If so, the referenced appliance does not support the requested command and accordingly at step **1314** an error message may be generated and the process thereafter terminated. As will be appreciated, the exact nature of such an error message may depend upon the particular embodiment and/or the requesting controlling device: for example, if the request originated from a controlling device which is in bidirectional communication with the UCE the error may be communicated back to the requesting device for action, i.e., display to the user, illuminate a LED, activate a buzzer, etc. as appropriate. Alter-

12

natively, in those embodiments where a UCE is incorporated into an appliance, that appliance's front panel display may be utilized.

If the retrieved preferred command matrix element data is valid, at step **1306** the UCE may communicate the corresponding function command to the target appliance using the indicated command value and transmission method, e.g., for the exemplary data element **720** this may comprise issuing a CEC "power on" command to CEC logical device address zero (TV) via the UCE HDMI interface **508**. Once the command has been issued, at step **1308** the UCE programming may determine if the communication interface and protocol used in issuing the command provides for any confirmation mechanism, i.e., explicit acknowledgement of receipt, monitoring of HDMI status on an interface, detection of a media stream or HDCP handshake, etc. If not, for example the command was issued using a unidirectional IR signal and no other confirmation means such as power or input signal monitoring is available, the UCE programming may simply assume that the command was successful and processing is complete. If however confirmation means exists, at step **1310** the UCE programming may wait to determine if the command was successfully executed. Once positive confirmation is received, processing is complete. If no confirmation or a negative confirmation is received, at step **1312** the UCE programming may determine if an alternative method is available to communicate the command to the target appliance. Returning to the specific example presented above this may comprise accessing a secondary command matrix **716** in order to determine if an alternative communication method is available for the specific function, e.g., "TV power on." If an alternative does exist, at step **1316** the substitute command value and transmission method may be retrieved and processing may return to step **1306** to initiate an alternative attempt. Returning again to the specific example, if the CEC "power on" command corresponding to data element **720** of matrix **700** issued to TV **106** cannot be confirmed, an IR "power on" command encoded according to SIRCS (Sony Infrared Control System) in correspondence with the equivalent data element in secondary matrix **716** may be attempted as a substitute.

In addition to relaying individual command requests as described above, an exemplary UCE may also support activity selection, whereby receipt of a single user request from a controlling device may cause a series of commands to be issued to various appliances in order to configure a system appropriately for a particular user activity, such as for example, watching television. To this end a set of matrices defining desired equipment states suitable to various activities, for example as illustrated at **1100** through **1102** of FIG. 11, may be stored in UCE memory **502** for access by UCE programming when executing such a request. As illustrated in FIG. 12, in some embodiments the programming of an exemplary UCE may maintain an additional matrix **1200** representative of the current state of the controlled appliances, arranged for example by appliance **1202** and by operational state **1204**. By way of example, data elements **1206** and **1208** in the illustrative table **1200** may indicate that TV **106** is currently powered on (**1208**) with HDMI port number **2** selected as the input (**1206**). The data contents of the elements in such a table may be maintained in any convenient manner as appropriate to a particular embodiment, for example without limitation retrieval of HDMI/CEC status; monitoring input media streams and/or HDCP status; measuring power consumption; construction of a simulated appliance state such as described for example

in U.S. Pat. No. 6,784,805; etc.; or any combination thereof. In the case of certain appliances, such as for example AV receiver **120** which may be controllable only via unidirectional IR, the current state of the appliance may not be discernible. In such cases, a null data element **1210** maybe entered into exemplary matrix **1200** to indicate that this appliance may require configuration using discrete commands only and/or user interaction. As will be appreciated, in some embodiments the data contents of the illustrative table may be maintained in memory **502** on an ongoing basis by UCE programming, while in other embodiments this data may be gathered “on the fly” at the time the activity request is being processed. Combinations of these methods may also be used, for example “on the fly” gathering for appliances connected via an HDMI bus combined with maintenance of a simulated state for appliances controlled via IR signals.

In order to configure a group of appliances for a desired activity, UCE programming may compare a desired state matrix, for example **1100**, to a current state matrix, for example **1200**, element by element, issuing commands as necessary to bring appliances to the desired state. By way of example, an exemplary series of steps which may be performed by the programming of a UCE in order to effect a “Watch TV” activity configuration will now be presented in conjunction with FIG. **14**. For the purposes of this example, the reader may also wish to reference the equipment configuration of FIG. **1** and the activity and current state matrices **1100** and **1200** of FIGS. **11** and **12**.

Upon receipt of a “Watch TV” request **1400**, at step **1402** the exemplary UCE programming may access an applicable appliance state matrix **1100**. Next, at step **1404** it may be determined by the UCE programming whether the present “power” state of TV **106** as indicated by current state matrix **1200** matches the desired state stored in the corresponding data element of matrix **1100**. If the states match, processing may continue at step **1408**. If the states do not match, at step **1406** a “power on” command may be communicated to TV **106**. As will be appreciated from the earlier discussion in conjunction with FIG. **13** and inspection of exemplary preferred command matrix **700**, in the illustrative system communication of the “power on” command to TV **106** may comprise a CEC command issued over HDMI connection **112**. Next, at step **1408** a “mute” command may be communicated to TV **106**, since element **1116** of illustrative matrix **1100** indicates that TV **106** is not the primary audio rendering appliance. In accordance with preferred command matrix **700**, communication of the “mute” command to TV **106** may comprise an IR transmission **114**. Thereafter, at steps **1410**, **1412** the active input of TV **106** may be set to “HDMI1” via a CEC command, and at steps **1414**, **1416** a CEC “power on” command may be communicated to STB/DVR **110** if that appliance is not already powered on. At step **1418**, the exemplary UCE programming may set an internal status to indicate that future transport command requests (e.g., play, pause, FF, etc.) should be routed to STB/DVR **110**, as indicated by element **1112** of matrix **1100**. Thereafter, at steps **1420**, **1422** a CEC “power off” command may be communicated to STB/DVR **108** if that appliance is not already powered off. Thereafter, at steps **1424** and **1426** “power on” and “input S/PDIF2” commands may be communicated to AV receiver **120** via IR signals. As will be appreciated, it may not be possible to determine the current status of AV receiver **120**, as indicated for example by elements **1210** and **1220** of matrix **1200**, and accordingly so-called “discrete,” or explicit, function commands may be issued which may establish the desired status regardless of the current state of the appliance. Finally, at step **1428** the

exemplary UCE programming may set an internal status to indicate that future volume control command requests (e.g. volume up/down, mute) should be routed to AV receiver **120**, as indicated by element **1118** of matrix **1100**, whereafter processing of the activity request is complete.

While various concepts have been described in detail, it will be appreciated by those skilled in the art that various modifications and alternatives to those concepts could be developed in light of the overall teachings of the disclosure. For example, in an alternate embodiment of UCE functionality, in place of a preferred command matrix such as illustrated in FIG. **7**, the programming of an exemplary UCE may utilize a command prioritization list, for example a prioritization list “IP, CEC, IR” may cause the UCE programming to first determine if the requested command can be issued using Internet Protocol, only if not, then determine if the requested command can be issued using a CEC command over the HDMI interface, and only if not, then attempt to issue the requested command via an infrared signal. Such a prioritization reflects an exemplary preference of using bi-directional communication protocols over unidirectional communication protocols over line of sight communication protocols, e.g., IR, when supported by the intended target appliance.

Further, while described in the context of functional modules and illustrated using block diagram format, it is to be understood that, unless otherwise stated to the contrary, one or more of the described functions and/or features may be integrated in a single physical device and/or a software module, or one or more functions and/or features may be implemented in separate physical devices or software modules. It will also be appreciated that a detailed discussion of the actual implementation of each module is not necessary for an enabling understanding of the invention. Rather, the actual implementation of such modules would be well within the routine skill of an engineer, given the disclosure herein of the attributes, functionality, and inter-relationship of the various functional modules in the system. Therefore, a person skilled in the art, applying ordinary skill, will be able to practice the invention set forth in the claims without undue experimentation. It will be additionally appreciated that the particular concepts disclosed are meant to be illustrative only and not limiting as to the scope of the invention which is to be given the full breadth of the appended claims and any equivalents thereof.

All patents cited within this document are hereby incorporated by reference in their entirety.

What is claimed is:

1. A method for delegating a transmission of commands directly to a target device to control volume operational functions of the target device in an entertainment system comprising a remote control device and an entertainment device communicatively coupled with the remote control device, the method comprising:

receiving by the entertainment device from the target device, via use of a High-Definition Multimedia Interface (“HDMI”) communication coupling between the entertainment device and the target device, data indicative of an identity of the target device; and

causing the entertainment device to delegate to itself the transmission of commands directly to the target device to control the volume operational functions of the target device when the received data indicative of the identity of the target device indicates that the target device supports receiving commands for controlling the volume operational functions of the target device via use of the HDMI communication coupling between the

15

target device and the entertainment device and to delegate to the remote control device the transmission of commands directly to the target device to control the volume operational functions of the target device when the received data indicative of the identity of the target device indicates that the target device fails to support receiving commands for controlling the volume operational functions of the target device via use of the HDMI communication coupling between the target device and the entertainment device.

2. The method as recited in claim 1, comprising issuing by the entertainment device to the target device a request for the data indicative of the identity of the target device.

3. The method as recited in claim 1, comprising configuring the remote control device to use an infrared communication protocol recognizable by the target device to transmit commands to control the volume operational functions of the target device when the transmission of commands directly to the target device to control the volume opera-

16

tional functions of the target device is delegated to the remote control device and configuring the remote control device to issue communications to the entertainment device to cause the entertainment device to transmit commands to control the volume operational functions of the target device when the transmission of commands directly to the target device to control the volume operational functions of the target device is delegated to the entertainment device.

4. The method as recited in claim 1, wherein the entertainment device uses a look-up table stored in a memory of the entertainment device to delegate the transmission of commands directly to the target device to control the volume operational functions of the target device to a one of the entertainment device and the remote control device.

5. The method as recited in claim 1, wherein the entertainment device and the remote control device are communicatively coupled via use of a radio frequency communications channel.

* * * * *